

R260-R3C

Dual LGA2011 sockets R3 motherboard for Intel® E5-2600 V3/V4 series processors

Service Guide

Rev. 1.1

Copyright

© 2016 GIGA-BYTE TECHNOLOGY CO., LTD. All rights reserved.

The trademarks mentioned in this manual are legally registered to their respective owners.

Disclaimer

Information in this manual is protected by copyright laws and is the property of GIGABYTE.

Changes to the specifications and features in this manual may be made by GIGABYTE without prior notice. No part of this manual may be reproduced, copied, translated, transmitted, or published in any form or by any means without GIGABYTE's prior written permission.

Documentation Classifications

In order to assist in the use of this product, GIGABYTE provides the following types of documentations:

- For detailed product information, carefully read the User's Manual.

For more information, visit our website at:

<http://b2b.gigabyte.com>

You are a professional?

Get an access to our complete source of sales, marketing & technical materials at:

<http://reseller.b2b.gigabyte.com>



<https://www.facebook.com/gigabyteserver>

Preface

Before using this information and the product it supports, please read the following general information.

1. This Service Guide provides you with all technical information relating to the BASIC CONFIGURATION decided for GIGABYTE's "global" product offering. To better fit local market requirements and enhance product competitiveness, your regional office MAY have decided to extend the functionality of a machine (e.g. add-on card, modem, or extra memory capability). These LOCALIZED FEATURES will NOT be covered in this generic service guide. In such cases, please contact your regional offices or the responsible personnel/channel to provide you with further technical details.
2. Please note WHEN ORDERING SPARE PARTS, you should check the most up-to-date information available on your regional web or channel. For whatever reason, if a part number change is made, it will not be noted in the printed Service Guide. For GIGABYTE-AUTHORIZED SERVICE PROVIDERS, your GIGABYTE office may have a DIFFERENT part number code to those given in the FRU list of this printed Service Guide. You MUST use the list provided by your regional GIGABYTE office to order FRU parts for repair and service of customer machines.

Table of Contents

Box Contents	7
Safety, Care and Regulatory Information	8
Chapter 1 Hardware Installation	11
1-1 Installation Precautions	11
1-2 Product Specifications	12
1-3 System Block Diagram	14
Chapter 2 System Hardware Installation	15
2-1 Removing Chassis Cover	16
2-2 Removing and Installing the Fan Duct	17
2-3 Installing the CPU	18
2-4 Installing the Heat Sink	19
2-5 Installing the Memory	20
2-5-1 Four Channel Memory Configuration	20
2-5-2 Installing a Memory	21
2-5-3 DIMM Population Table	21
2-5 Installing the PCI Expansion Card	22
2-6 Installing the Hard Disk Drive	23
2-7 Replacing the FAN Assembly	24
2-8 Replacing and Installing the Power Supply	25
2-9 Installing Rail Into A Rack	26
Chapter 3 System Appearance	27
3-1 Front View	27
3-2 Rear View	27
3-3 Front Panel LED and Buttons	28
3-4 Rear System LAN LEDs	30
3-5 Hard Disk Drive LEDs	31
3-6 Cable Routing	32
Chapter 4 Motherboard Components	33
4-1 MD50-LS0 Motherboard Components	33
4-2 Jumper Setting	36
Chapter 5 BIOS Setup	38
5-1 The Main Menu	40

5-2	Advanced Menu	43
5-2-1	Serial Port Console Redirection	44
5-2-2	PCI Subsystem Settings	48
5-2-2-1	PCI Express Settings	50
5-2-3	Network Stack	52
5-2-4	CSM Configuration	53
5-2-5	Post Report Configuration	55
5-2-6	Trusted Computing	56
5-2-7	USB Configuration	57
5-2-8	Chipset Configuration	58
5-9	SIO Configuration	59
5-2-10	iSCSI Configuration	63
5-3	Intel RC Setup Menu	64
5-3-1	Processor Configuration	65
5-3-1-1	Pre-Socket Configuration	68
5-3-2	Advanced Power Management Configuration	70
5-3-2-1	CPU P State Control	71
5-3-2-2	CPU C State Control	72
5-3-2-3	CPU T State Control	73
5-3-3	Common RefCode Configuration	74
5-3-4	QPI Configuration	75
5-3-5	Memory Configuration	77
5-3-5-1	Memory Topology	79
5-3-5-2	Memory Thermal	80
5-3-5-3	Memory Map	81
5-3-5-4	Memory RAS Configuration	82
5-3-6	IIO Configuration	83
5-3-6-1	IOAT Configuration	84
5-3-6-2	Intel VT for Directed I/O (VT-d)	85
5-3-7	PCH Configuration	86
5-3-7-1	PCH Devices	87
5-3-7-2	PCH sATA Configuration	88
5-3-7-2-1	SATA Mode Options	91
5-3-7-3	PCH SATA Configuration	93
5-3-7-3-1	SATA Mode Options	96
5-3-7-4	USB Configuration	98
5-3-8	Miscellaneous Configuration	99
5-3-9	Server ME Configuration	100
5-3-10	Runtime Error Logging	101
5-3-10-1	Whea Setting	102
5-3-10-2	Memory Error Enabling	103
5-3-10-3	PCI/PCI Error Enabling	104

5-4	Server Management Menu.....	105
5-4-1	System Event Log	107
5-4-2	View FRU Information	108
5-4-3	BMC network configuration	109
5-5	Security Menu	110
5-5-1	Secure Boot menu	111
5-5-1-1	Key Management	112
5-6	Boot Menu.....	114
5-7	Save & Exit Menu.....	116
5-8	BIOS POST Codes	118
5-9	BIOS POST Beep code.....	122
5-9-1	PEI Beep Codes	122
5-9-2	DEX Beep Codes	122
5-10	BIOS Recovery Instruction.....	123

Box Contents

- R260-R3C System
- Driver CD
- Two CPU Heat Sinks
- Rai Kit

- The box contents above are for reference only and the actual items shall depend on the product package you obtain. The box contents are subject to change without notice.
- The motherboard image is for reference only.

Safety, Care and Regulatory Information

Important safety information

Read and follow all instructions marked on the product and in the documentation before you operate your system. Retain all safety and operating instructions for future use.

- The product should be operated only from the type of power source indicated on the rating label.* If your computer has a voltage selector switch, make sure that the switch is in the proper position for your area. The voltage selector switch is set at the factory to the correct voltage.
- The plug-socket combination must be accessible at all times because it serves as the main disconnecting device.
- All product shipped with a three-wire electrical grounding-type plug only fits into a grounding-type power outlet. This is a safety feature. The equipment grounding should be in accordance with local and national electrical codes. The equipment operates safely when it is used in accordance with its marked electrical ratings and product usage instructions
- Do not use this product near water or a heat source.* Set up the product on a stable work surface or so as to ensure stability of the system.
- Openings in the case are provided for ventilation. Do not block or cover these openings. Make sure you provide adequate space around the system for ventilation when you set up your work area. Never insert objects of any kind into the ventilation openings.
- To avoid electrical shock, always unplug all power cables and modem cables from the wall outlets before removing covers.
- Allow the product to cool before removing covers or touching internal components.

Precaution for Product with Laser Devices

Observe the following precautions for laser devices:

- Do not open the CD-ROM drive, make adjustments, or perform procedures on a laser device other than those specified in the product's documentation.
- Only authorized service technicians should repair laser devices.

Precaution for Product with Modems, Telecommunications, or Local Area Network Options

Observe the following precautions for laser devices:

- Do not connect or use a modem or telephone during a lightning storm. There may be a risk of electrical shock from lightning.
- To reduce the risk of fire, use only No. 26 AWG or larger telecommunications line cord.
- Do not plug a modem or telephone cable into the network interface controller (NIC) receptacle.
- Disconnect the modem cable before opening a product enclosure, touching or installing internal components, or touching an uninsulated modem cable or jack.
- Do not use a telephone line to report a gas leak while you are in the vicinity of the leak.

Federal Communications Commission (FCC) Statement

Warning

This is a class A product. In a domestic environment this product may cause radiointerference in which case the user may be required to take adequate measures.

This equipment has been tested and found to comply with the limits for a Class A digital device, pursuant to Part 15 of the FCC Rules. These limits are designed to provide reasonable protection against harmful interference when the equipment is operated in a commercial environment. This equipment generates, uses, and can radiate radio frequency energy and, if not installed and used in accordance with the instruction manual, may cause harmful interference to radio communications. Operation of this equipment in a residential area is likely to cause harmful interference in which case the user will be required to correct the interference at his own expense. Properly shielded and grounded cables and connectors must be used in order to meet FCC emission limits. Neither the provider nor the manufacturer are responsible for any radio or television interference caused by using other than recommended cables and connectors or by unauthorized changes or modifications to this equipment. Unauthorized changes or modifications could void the user's authority to operate the equipment. This device complies with Part 15 of the FCC Rules. Operation is subject to the following two conditions:

- (1) this device may not cause harmful interference, and
- (2) this device must accept any interference received, including interference that may cause undesired operation.

Canadian Department of Communications Compliance Statement

This digital apparatus does not exceed the Class A limits for radio noise emissions from digital apparatus as set out in the radio interference regulations of Industry Canada. Le présent appareil numérique n'émet pas de bruits radioélectriques dépassant les limites applicables aux appareils numériques de Classe A prescrites dans le règlement sur le brouillage radioélectrique édicté par Industrie Canada.

Class A equipment

This device has been tested and found to comply with the limits for a class A digital device pursuant Part 15 of the FCC Rules. These limits are designed to provide reasonable protection against harmful interference when the equipment is operated in a commercial environment. This equipment generate, uses, and can radiate radio frequency energy, and if not installed and used in accordance with the instructions, may cause harmful interference to radio communication. Operation of this equipment in a residential area is likely to cause harmful interference, in which case the user will be required to correct the interference at personal expense.

However, there is no guarantee that interference will not occur in a particular installation. If this device does cause harmful interference to radio or television reception, which can be determined by tuning the device off and on, the user is encouraged to try to correct the interference by one or more of the following measures:

- Reorient or relocate the receiving antenna
- Increase the separation between the device and receiver
- Connect the device into an outlet on a circuit different from that to which the receiver is connected' Consult the dealer or an experienced radio/television technician for help.

California Proposition 65

Warning:

This product contains a chemical, including lead, known to the State of California to cause cancer

<http://www.p65warnings.ca.gov/>

Warning:

This product contains a chemical, including lead, known to the State of California to cause birth defects or other reproductive harm.

<http://www.p65warnings.ca.gov/>

WEEE Symbol Statement



The symbol shown below is on the product or on its packaging, which indicates that this product must not be disposed of with other waste. Instead, the device should be taken to the waste collection centers for activation of the treatment, collection, recycling and disposal procedure.

The separate collection and recycling of your waste equipment at the time of disposal will help to conserve natural resources and ensure that it is recycled in a manner that protects human health and the environment. For more information about where you can drop off your waste equipment for recycling, please contact your local government office, your household waste disposal service or where you purchased the product for details of environmentally safe recycling.

- ◆ When your electrical or electronic equipment is no longer useful to you, "take it back" to your local or regional waste collection administration for recycling.
- ◆ If you need further assistance in recycling, reusing in your "end of life" product, you may contact us at the Customer Care number listed in your product's user's manual and we will be glad to help you with your effort.



Battery Warning: Incorrectly installing a battery or using incompatible battery may increase the risk of fire explosion. Replace the battery only with the same or equivalent type.

- Do not disassemble, crush, puncture batteries.
- Do not store or place your battery pack next to or in a heat source such as a fire, heat-generating appliance, can or exhaust vent. Heating battery cells to temperatures above 65°C (149°F) can cause explosion or fire.
- Do not attempt to open or service batteries. Do not dispose of batteries in a fire or with household waste.









Chapter 1 Hardware Installation

1-1 Installation Precautions

The motherboard/system contain numerous delicate electronic circuits and components which can become damaged as a result of electrostatic discharge (ESD). Prior to installation, carefully read the service guide and follow these procedures:

- Prior to installation, do not remove or break motherboard S/N (Serial Number) sticker or warranty sticker provided by your dealer. These stickers are required for warranty validation.
- Always remove the AC power by unplugging the power cord from the power outlet before installing or removing the motherboard or other hardware components.
- When connecting hardware components to the internal connectors on the motherboard, make sure they are connected tightly and securely.
- When handling the motherboard, avoid touching any metal leads or connectors.
- It is best to wear an electrostatic discharge (ESD) wrist strap when handling electronic components such as a motherboard, CPU or memory. If you do not have an ESD wrist strap, keep your hands dry and first touch a metal object to eliminate static electricity.
- Prior to installing the motherboard, please have it on top of an antistatic pad or within an electrostatic shielding container.
- Before unplugging the power supply cable from the motherboard, make sure the power supply has been turned off.
- Before turning on the power, make sure the power supply voltage has been set according to the local voltage standard.
- Before using the product, please verify that all cables and power connectors of your hardware components are connected.
- To prevent damage to the motherboard, do not allow screws to come in contact with the motherboard circuit or its components.
- Make sure there are no leftover screws or metal components placed on the motherboard or within the computer casing.
- Do not place the computer system on an uneven surface.
- Do not place the computer system in a high-temperature environment.
- Turning on the computer power during the installation process can lead to damage to system components as well as physical harm to the user.
- If you are uncertain about any installation steps or have a problem related to the use of the product, please consult a certified computer technician.

1-2 Product Specifications

	CPU	<ul style="list-style-type: none"> ◆ Support for Intel® Xeon® E5-2600 V3/V4 series processors in the LGA2011 package ◆ L3 cache varies with CPU ◆ Supports Dual QuickPath Interconnect up to 9.6GT/s ◆ Enhanced Intel SpeedStep Technology (EIST) ◆ Support Intel Virtualization Technology (VT)
	Chipset	<ul style="list-style-type: none"> ◆ Intel® C612 Express (Wellsburg) Chipset
	Memory	<ul style="list-style-type: none"> ◆ 8 x DIMM slots ◆ DDR4 memory supported only ◆ Quad channel memory architecture ◆ ECC RDIMM / LRDIMM modules supported ◆ Single and dual rank RDIMM modules up to 32GB supported ◆ 3DS LRDIMM modules up to 128GB supported ◆ 1.2V modules: 1600/1866/2133/2400 MHz
	LAN	<ul style="list-style-type: none"> ◆ 4 x Intel® I210 supports GbE LAN ports ◆ 1 x Management LAN 10/100/1000Mbps LAN port
	Expansion Slot	<ul style="list-style-type: none"> ◆ 1 x PCI Express x16 slot, running at x16 (Gen3/PCIE_3) ◆ 3 x PCI Express x16 slot, running at x8 (Gen3/PCIE_4/PCIE_5/PCIE_6) ◆ 2 x PCI Express x16 slot, running at x4 (Gen3/PCIE_1/PCIE_2) ◆ 1 x PCI Express mezzanine type T, running at x8 (Gen3/RAID_SLOT1&2)
	Onboard Graphics	<ul style="list-style-type: none"> ◆ ASPEED® AST2400 supports 16MB DDR3 VRAM
	Mass Storage	<ul style="list-style-type: none"> ◆ 12 x 3.5" Hot-Swap SATA/SAS HDD/SSD bays ◆ Default configuration supports: <ul style="list-style-type: none"> ◆ 4 x SATA III 6Gb/s drives ◆ Adapter card required to enable the 8 remaining drive bays ◆ Recommended: RA200-8 SAS card
	System Fans	<ul style="list-style-type: none"> ◆ 4 x 80x80x38mm/149000rpm
	USB	<ul style="list-style-type: none"> ◆ 4 x USB 3.0 ports (back panel) ◆ 2 x USB 2.0 ports (back panel)

	Internal Connectors	<ul style="list-style-type: none"> ◆ 1 x 24-pin ATX main power connector ◆ 2 x 8-pin ATX 12V power connector ◆ 8 x SAS connectors ◆ 10 x SATA3 6Gb/s connectors ◆ 1 x PMBus header ◆ 5 x System fan headers ◆ 1 x Front panel header ◆ 1 x HDD Back plane board header ◆ 1 x USB 3.0 header ◆ 1 x TPM module connector ◆ 1 x Serial port connector ◆ 2 x SATA SPGIO headers ◆ 2 x SAS SPGIO headers ◆ 1 x Software RAID key connector ◆ 1 x IPMB connector
	Rear Panel I/O	<ul style="list-style-type: none"> ◆ 4 x USB 3.0 ports ◆ 2 x USB 2.0 ports ◆ 5 x RJ-45 ports (1 x 10/100/1000 Mbps dedicated management LAN port) ◆ 1 x COM port ◆ 1 x VGA port ◆ 1 x PS/2 connector ◆ 1 x ID Button/LED
	Front Panel LED/Buttons	<ul style="list-style-type: none"> ◆ 1 x Power button/LED ◆ 1 x System status LED ◆ 1 x ID Switch button/LED ◆ 1 x Reset button ◆ 2 x LAN LEDs ◆ 1 x HDD status LED
	I/O Controller	<ul style="list-style-type: none"> ◆ ASPEED® AST2400 BMC chip
	Hardware Monitor	<ul style="list-style-type: none"> ◆ System voltage detection ◆ CPU/System temperature detection
	BIOS	<ul style="list-style-type: none"> ◆ 1 x 128 Mbit flash ◆ AMI BIOS
	Environment Ambient Temperature	<ul style="list-style-type: none"> ◆ Operating Temperature: 10°C to 35°C ◆ Non-operating Temperature: -40°C to 60°C
	Relative Humidity	<ul style="list-style-type: none"> ◆ Operating Humidity: 8-80% operating Humidity (non-condensing) ◆ Non-operating Humidity: 20-95% operating Humidity (non-condensing)
	System Dimension	<ul style="list-style-type: none"> ◆ 430Wx87Hx712.4D (mm)
	Electrical Power Supply	<ul style="list-style-type: none"> ◆ 2 x Redundant PSU 750W 100-240VAC at 80 plus gold level

* GIGABYTE reserves the right to make any changes to the product specifications and product-related information without prior notice.

1-3 System Block Diagram

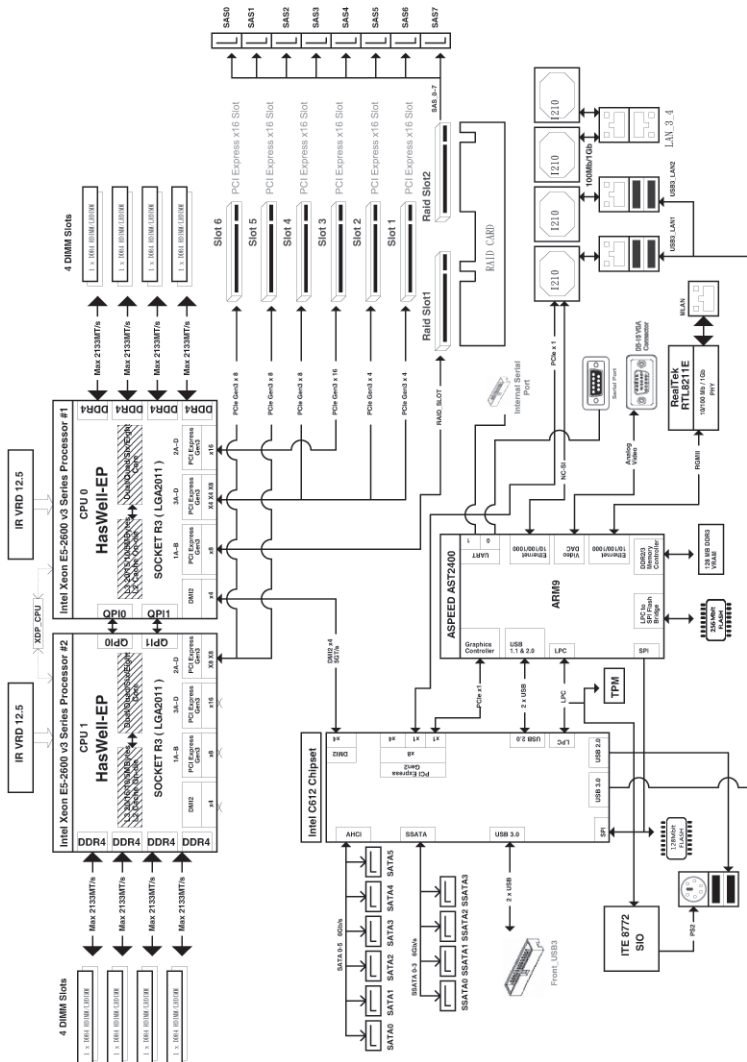

Chapter 2 System Hardware Installation

Pre-installation Instructions



Perform the steps below before you open the server or before you remove or replace any component.

- Back up all important system and data files before performing any hardware configuration.
- Turn off the system and all the peripherals connected to it.
- Locate the pin one of the CPU. The CPU cannot be inserted if oriented incorrectly. (Or you may locate the notches on both sides of the CPU and alignment keys on the CPU socket.)
- Apply an even and thin layer of thermal grease on the surface of the CPU.
- Do not turn on the computer if the CPU cooler is not installed, otherwise overheating and damage of the CPU may occur.
- Set the CPU host frequency in accordance with the CPU specifications. It is not recommended that the system bus frequency be set beyond hardware specifications since it does not meet the standard requirements for the peripherals. If you wish to set the frequency beyond the standard specifications, please do so according to your hardware specifications including the CPU, graphics card, memory, hard drive, etc.

2-1 Removing Chassis Cover



Before you remove or install the system cover

- Make sure the system is not turned on or connected to AC power.

Follow these instructions to remove the system cover:

1. Loosen and remove the screws securing the back cover.
2. Loosen and remove the screws securing the front cover.
3. Remove the front cover.
4. Slide the back cover toward the rear of the chassis to disengage it.

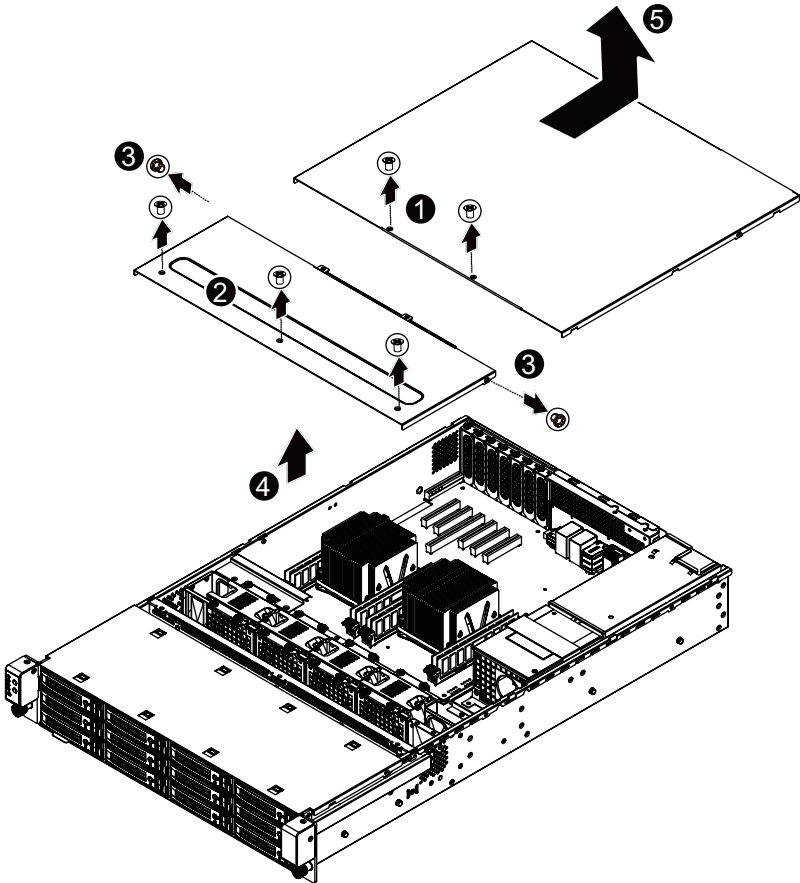

2-2 Removing and Installing the Fan Duct

Follow these instructions to remove/install the fan duct:

1. Loosen and remove the screws securing the screw.
2. Lift up to remove the fan duct
3. To install the fan duct, align the fan duct with the guiding groove. Push down the fan duct into chassis until its firmly seats

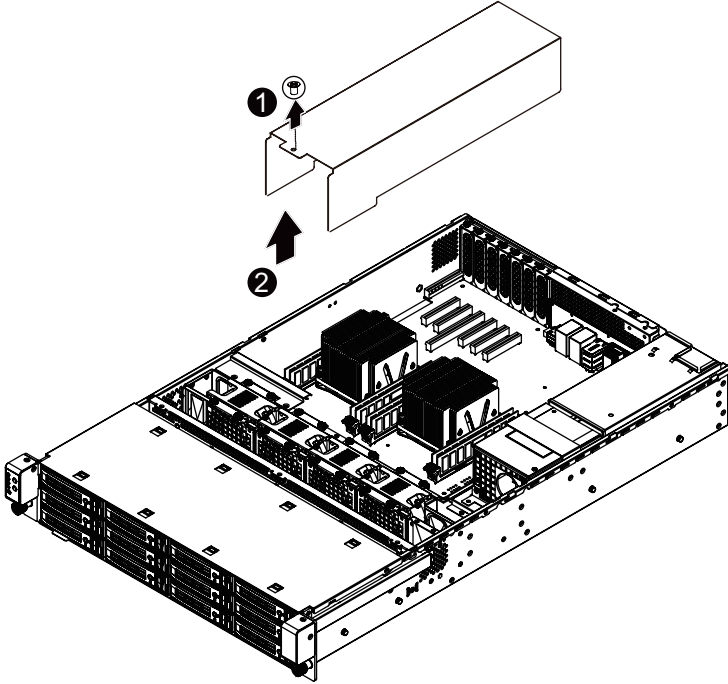

2-3 Installing the CPU



Read the following guidelines before you begin to install the CPU:

- Make sure that the motherboard supports the CPU.
- Always turn off the computer and unplug the power cord from the power outlet before installing the CPU to prevent hardware damage.
- Unplug all cables from the power outlets.
- Disconnect all telecommunication cables from their ports.
- Place the system unit on a flat and stable surface.
- Open the system according to the instructions.

WARNING!

Failure to properly turn off the server before you start installing components may cause serious damage. Do not attempt the procedures described in the following sections unless you are a qualified service technician.

Follow these instructions to install the CPU:

1. Raise the metal locking lever on the socket.
2. Remove the plastic covering on the CPU socket. Insert the CPU with the correct orientation. The CPU only fits in one orientation.
3. Replace the metal cover.
4. Push the metal lever back into locked position.

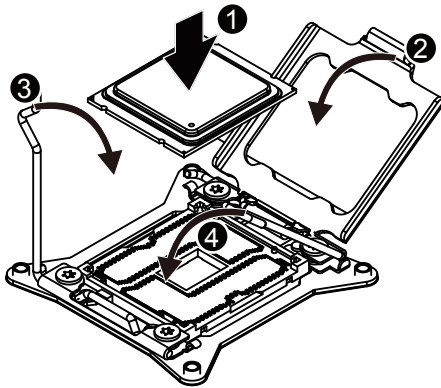

2-4 Installing the Heat Sink

Follow these instructions to install the heat sinks:

1. Apply thermal compound evenly on the top of the CPU.
2. Remove the protective cover from the underside of the heat sink.
3. Place the heat sink(s) on top of the CPU and tighten the four positioning screws.

WARNING!



- When you are installing the heat sink on the CPU, ensure the cooling fan is facing the rear I/O of the system.
- Improper installation could cause system overheating and damage to equipment.

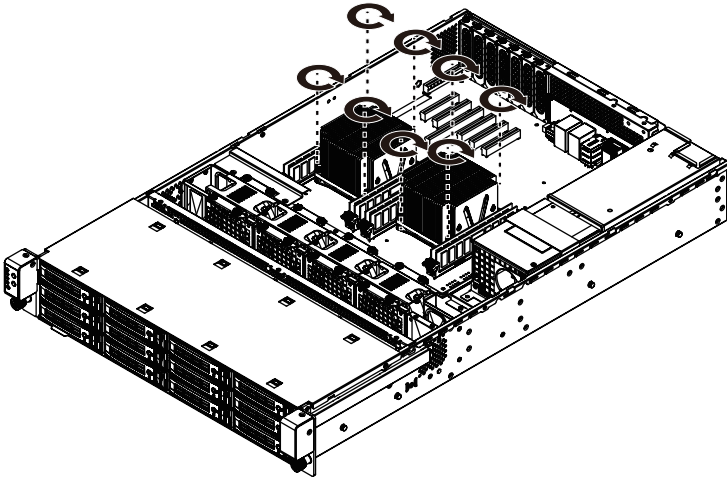

2-5 Installing the Memory



Read the following guidelines before you begin to install the memory:

- Make sure that the motherboard supports the memory. It is recommended that memory of the same capacity, brand, speed, and chips be used.
- Always turn off the computer and unplug the power cord from the power outlet before installing the memory to prevent hardware damage.
- Memory modules have a foolproof design. A memory module can be installed in only one direction. If you are unable to insert the memory, switch the direction.

2-5-1 Four Channel Memory Configuration

This motherboard provides eight DDR4 memory sockets and supports Four Channel Technology. After the memory is installed, the BIOS will automatically detect the specifications and capacity of the memory. Enabling Four Channel memory mode will be four times of the original memory bandwidth.

The four DDR4 memory sockets are divided into four channels each channel has two memory sockets as following:

Channel 1: DIMM_P0_A0 (For primary CPU)/DIMM_P1_E0 (For secondary CPU)

Channel 2: DIMM_P0_B0 (For primary CPU)/DIMM_P1_F0 (For secondary CPU)

Channel 3: DIMM_P0_C0 (For primary CPU)/DIMM_P1_G0 (For secondary CPU)

Channel 4: DIMM_P0_D0 (For primary CPU)/DIMM_P1_H0 (For secondary CPU)

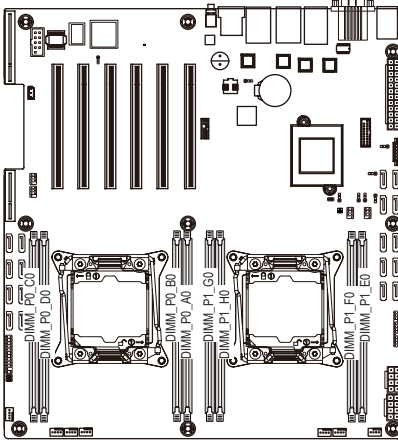

2-5-2 Installing a Memory



Before installing a memory module, make sure to turn off the computer and unplug the power cord from the power outlet to prevent damage to the memory module.

Be sure to install DDR4 DIMMs on this motherboard.

Follow these instructions to install the Memory:

1. Insert the DIMM memory module vertically into the DIMM slot, and push it down.
2. Close the plastic clip at both edges of the DIMM slots to lock the DIMM module.
3. Reverse the installation steps when you want to remove the DIMM module.

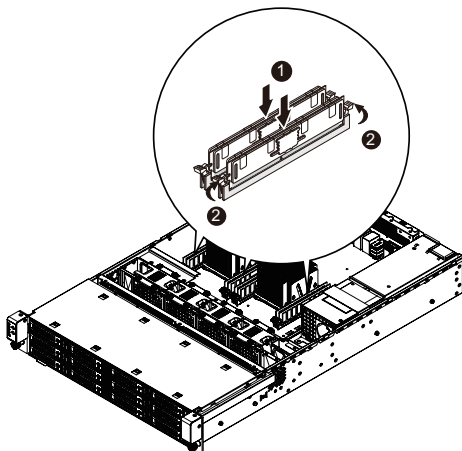

2-5-3 DIMM Population Table

Type	Ranks Per DIMM and Data Width	Speed (MT/s); Slot Per Channel (SPC) and DIMM Per Channel (DPC)		
		1 Slot Per Channel	2 Slot Per Channel	
		1DPC	1DPC	2DPC
RDIMM	SRx4	2133	2133	1866
RDIMM	SRx8	2133	2133	1866
RDIMM	DRx8	2133	2133	1866
RDIMM	DRx4	2133	2133	1866
LRDIMM	QRx4	2133	2133	2133
LRDIMM 3DS	8Rx4	2400	2400	2400



NOTE!

DDR4 2400MHz is only available on Intel Xeon® E5-2600 V4 processor.



When only one DIMM is used, it must be populated in memory slot0 first.

Memory populated sequence must be followed with slot0/slot1/slot2.

System will not boot normally with incorrect populated sequence.

2-5 Installing the PCI Expansion Card



- Voltages can be present within the server whenever an AC power source is connected. This voltage is present even when the main power switch is in the off position. Ensure that the system is powered-down and all power sources have been disconnected from the server prior to installing a PCI card.
Failure to observe these warnings could result in personal injury or damage to equipment.



- The PCI riser assembly does not include a riser card or any cabling as standard. To install a PCI card, a riser card must be installed.

Follow these instructions to PCI Expansion card:

1. Remove the securing screw on the PCI bracket.
2. Insert the card into the selected slot and secure the expansion card with screw.
Make sure that the card is properly seated.

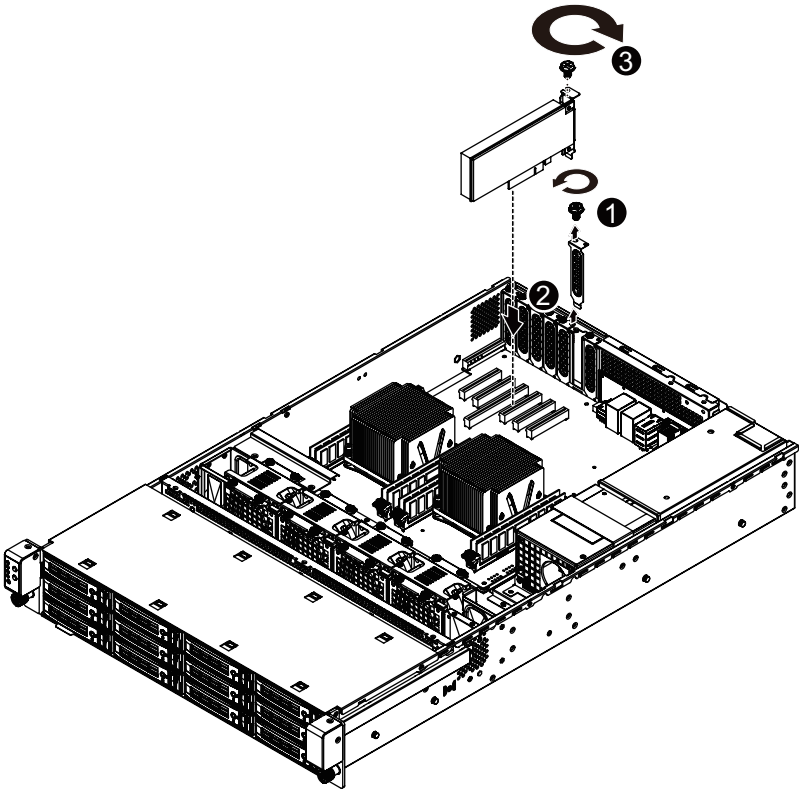

2-6 Installing the Hard Disk Drive

Read the following guidelines before you begin to install the Hard disk drive:



- Take note of the drive tray orientation before sliding it out.
- The tray will not fit back into the bay if inserted incorrectly.
- Make sure that the HDD is connected to the HDD connector on the backplane.

Follow these instructions to install the Hard disk drive:

1. Press the release button.
2. Pull the locking lever to remove the HDD tray.
3. Slide hard disk into blank.
4. Secure the hard drive to the tray with four (4) screws as shown. Do not over tighten the screws.
5. Slide the blank into the bay until it locks into place.

CAUTION!



We strongly recommend using enterprise level hard disk drive in Gigabyte server system. For more information of recommended HDDs, please visit Gigabyte website: <https://www.gigabyte.com> and search for the specific product QVL from **Support & Downloads**.

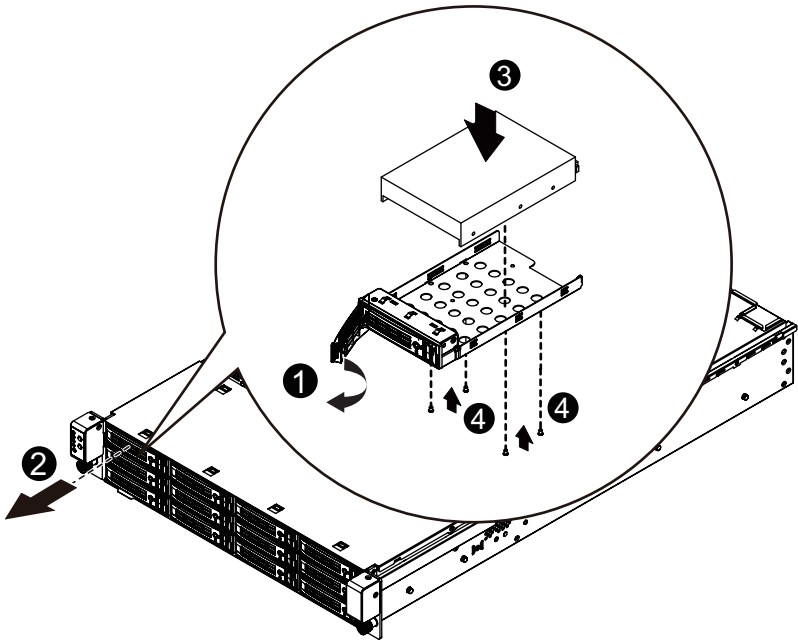

2-7 Replacing the FAN Assembly

Follow these instructions to replace the fan assembly:

1. Lift up the fan assembly from the chassis.
2. Reverse the previous step to install the replacement fan assembly.

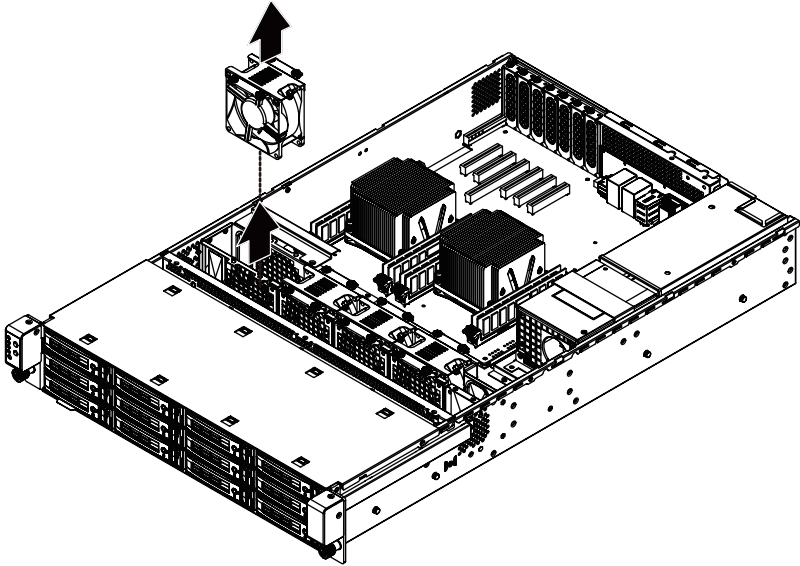

2-8 Replacing and Installing the Power Supply

Follow these instructions to replace the power supply:

1. Disconnect the three power cables.
2. With the existing power supply, pull up the power supply handle and press the retaining clip on the right side of the power supply along the direction of the arrow. At the same time, pull out the power supply by using its handle.
3. Insert the replacement power supply firmly into the chassis. Connect the AC power cord to the replacement power supply.
4. Remove the securing screws on the dummy cover.
5. Insert a new power supply firmly into the chassis.

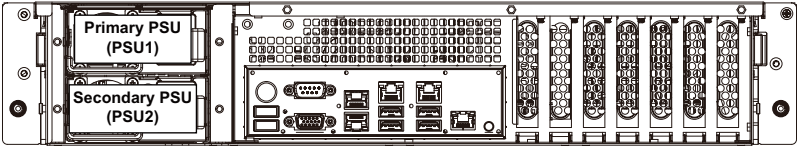
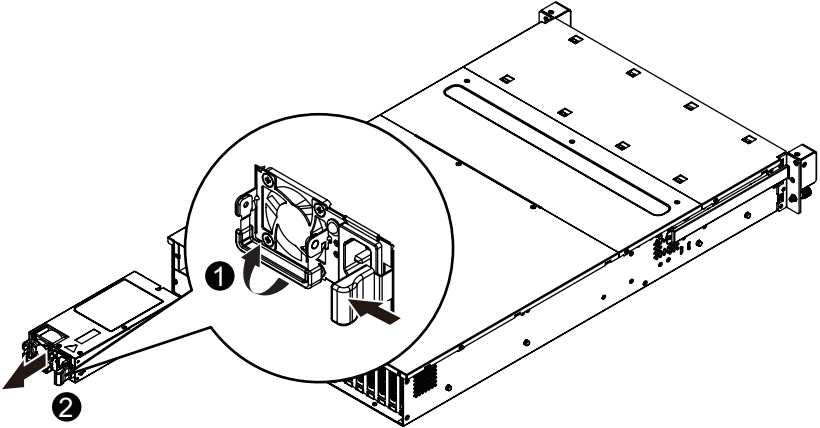

CAUTION!



- Please see the illustrated for installation sequence.

2-9 Installing Rail Into A Rack

Follow these instructions to install the rail into a rack:

1. Release and detach the inner rail from the slide.
2. Attach the unit to the inner rail.
3. Fix the outer rail/bracket assembly to the frame.
4. Insert the unit to complete the installation.

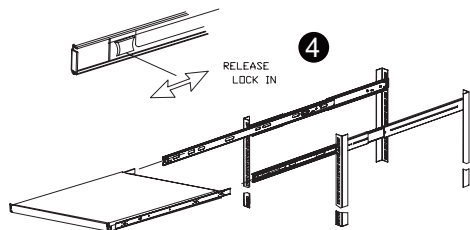
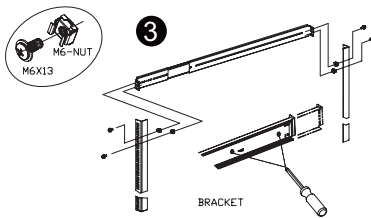
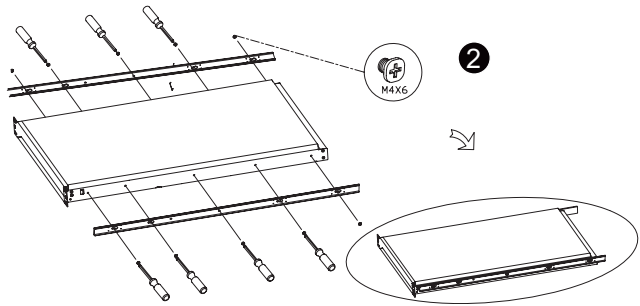
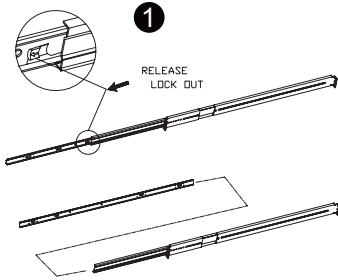

Chapter 3 System Appearance

3-1 Front View

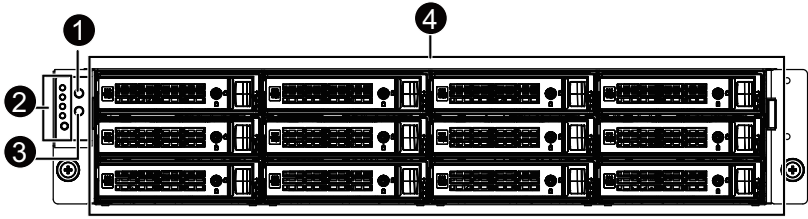

No.	Description
1.	Power button and LED
2.	Front Panel LEDs and buttons
3.	ID button and LED
4.	3.5-inch hard disk drive (HDD)

3-2 Rear View

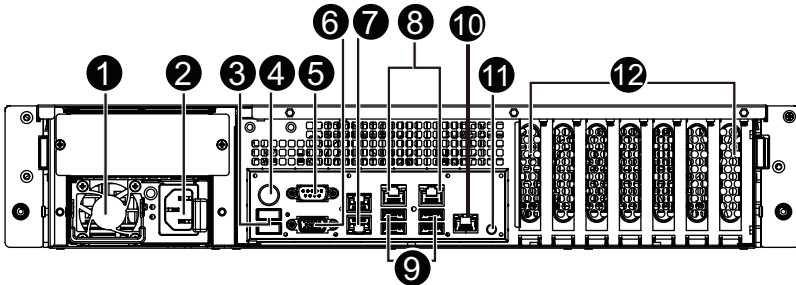

No.	Description
1.	Power supply fan
2.	Power supply module cord socket
3.	USB 2.0 ports
4.	PS/2 keyboard/mouse port
5.	Serial port
6.	VGA port
7.	LAN ports
8.	LAN ports
9.	USB 3.0 ports
10.	10/100/1000 Server management LAN port
11.	ID switch button
12.	PCI card bays



Please Go to Chapter 3-3 Front Panel LED and Buttons for detail description of function LEDs.

3-3 Front Panel LED and Buttons

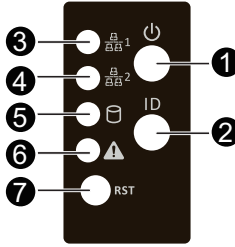

No.	Name	Color	Status	Critical Event	Description
1.	Power button and LED	Green	On	N/A	System has power applied to it or ACPI S0 state
		Green	Blink	N/A	System is in ACPI S1 state (sleep mode)
		N/A	Off	N/A	System is not powered on or in ACPI S5 state (power off)
		N/A	Off	N/A	System is in ACPI S4 state (hibernate mode)
2.	ID button and LED	Blue	On	N/A	System identification is active
		N/A	Off	N/A	System identification is disabled
3.	LAN1 LED	Green	Solid On	N/A	Link between system and network or no access
		Green	Blink	N/A	Data transmission or receiving is occurring
		N/A	Off	N/A	No data transmission or receiving is occurring
4.	LAN 2 LED	Green	Solid On	N/A	Link between system and network or no access
		Green	Blink	N/A	Data transmission or receiving is occurring
		N/A	Off	N/A	No data transmission or receiving is occurring
5.	HDD Status LED	Green	On	N/A	HDD locate
		Green	Blink	N/A	HDD access
		Amber	On	N/A	HDD fault
		Green/Amber	Blink	N/A	HDD rebuilding
		N/A	Off	N/A	<ul style="list-style-type: none"> No HDD access No HDD fault

6.	System Status LED	Green	Solid On	N/A	System is operating normally.
		Amber	Solid On	Yes	Critical condition, may indicate the following: <ul style="list-style-type: none"> • Power module failure • System fan failure • Power supply voltage issue • System temperature/voltage issue • Current error/Processor error/ Critical memory error
			Blink	N/A	Non-critical condition, may indicate the following: <ul style="list-style-type: none"> • Redundant power module failure (AC lost) • Temperature and voltage issue • Current error • Chassis intrusion • Event Logs almost full
		N/A	Off	N/A	System is not ready. May indicate the following: <ul style="list-style-type: none"> • POST error • NMI error • Processor or terminator missing
7.	Reset button				Press the button to reset the system.

3-4 Rear System LAN LEDs

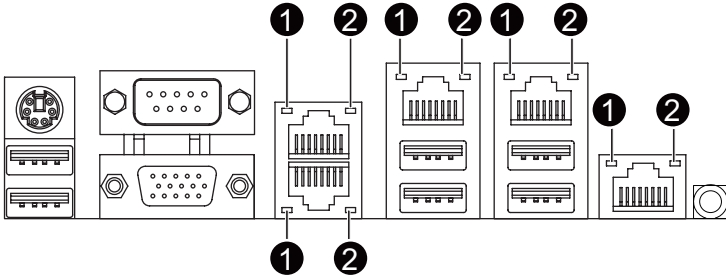

No.	Name	Color	Status	Description
1.	1 GbE Speed LED	Yellow	On	1 Gbps data rate
		Green	On	100 Mbps data rate
		N/A	Off	10 Mbps data rate
2.	1 GbE Link/Activity LED	Green	On	Link between system and network or no access
			Blink	Data transmission or receiving is occurring
		N/A	Off	No data transmission or receiving is occurring

3-5 Hard Disk Drive LEDs



No	Description	Multi Color LEDs	
		LED Active Green	LED Active Amber
1	HDD Access	Blink	Off
	HDD Locate	On	Off
	HDD Failure	Off	On
	HDD connected and rebuilding data	Blink	Blink (Alternative)
2	Reserve		

3-6 Cable Routing

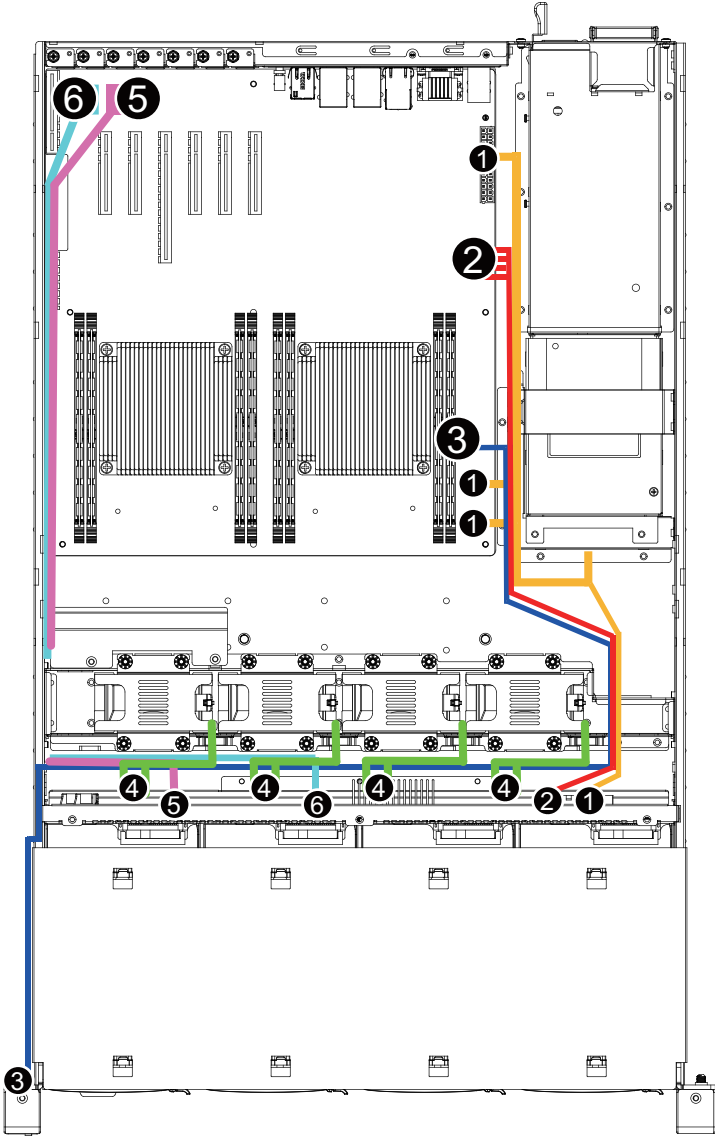

No.	Suggest Cable	No.	Suggest Cable
1.	System main power cable	2.	SATA HDD cable
3.	Front switch cable/Front LED cable	4.	System fan power cable
5.	Mini SAS HDD back plane cable #2	6.	Mini SAS HDD back plane cable #1

Chapter 4 Motherboard Components

4-1 MD50-LS0 Motherboard Components

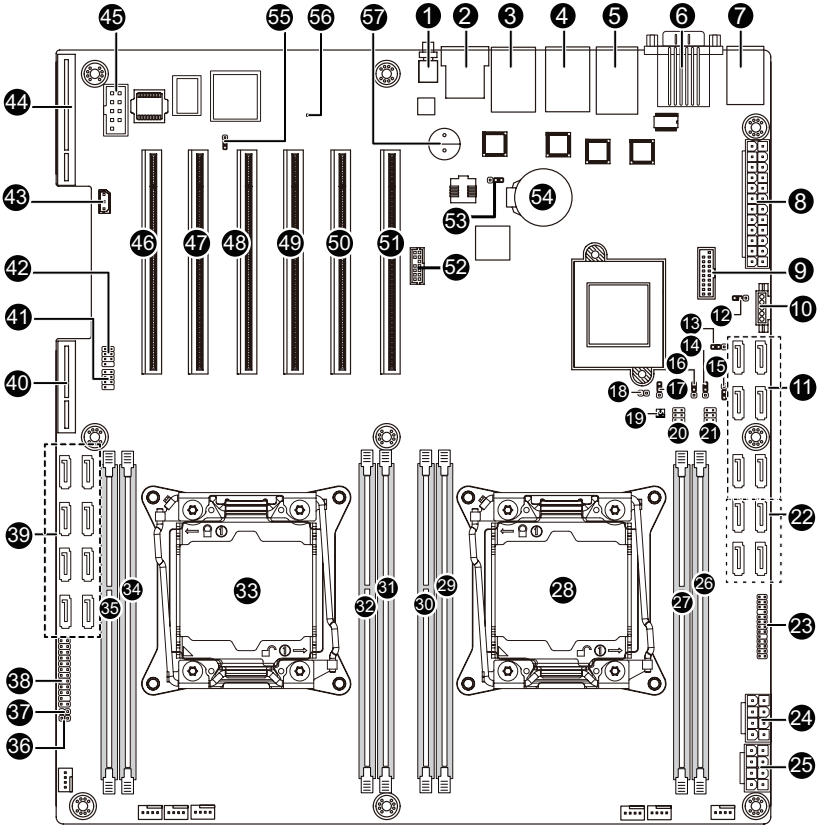

Item	Code	Description
1	SW_ID	ID switch button
2	MLAN	BMC Management LAN port
3	USB3_LAN1	LAN port #1 (top)/USB 3.0 ports (bottom)
4	USB3_LAN2	LAN port #2 (top)/USB 3.0 ports (bottom)
5	LAN3_4	LAN port #3/#4
6	COM1_VGA	Serial port (top)/VGA port(bottom)
7	PS2_USB	PS/2 connector (top)/USB 2.0 ports (bottom)
8	ATX1	24 pin main power connector
9	F_USB3	USB 3.0 header
10	PMBUS	PMBus connector
11	SATA0/SATA1/SATA2/SATA3/ SATA4/SATA5	SATA 3 6Gb/s connector
12	SATA_DOM1	SATA port 1 DOM support jumper
13	BIOS_PWD	Clearing Supervisor Password jumper
14	ME_UPDATE	ME update jumper
15	S3_MASK	S3 Power On Select jumper
16	ME_RCVR	ME recovery jumper
17	BIOS_RCVR	BIOS recovery jumper
18	CASE_OPEN	Case open intrusion alert header
19	SW_RAID	Software RAID Key jumper
20	SATA_SGP	sSATA SGPIO header #2
21	SSATA_SGP	sSATA SGPIO header #1
22	S S A T A 0 / S S A T A 1 / S S A T A 2 / SSATA3	SATA 3 6Gb/s connector
23	BP_1	HDD back plane board header
24	P12V_AUX2	8 pin power connector (for secondary CPU)
25	P12V_AUX1	8 pin power connector (for primary CPU)
26	DIMM_P1_E0	Channel 1 slot (for secondary CPU)
27	DIMM_P1_F0	Channel 2 slot (for secondary CPU)
28	CPU1	Intel LGA2011 Socket R3 (Secondary CPU)
29	DIMM_P1_H0	Channel 4 slot (for secondary CPU)
30	DIMM_P1_G0	Channel 3 slot (for secondary CPU)
31	DIMM_P0_A0	Channel 1 slot (for primary CPU)
32	DIMM_P0_B0	Channel 2 slot (for primary CPU)
33	CPU0	Intel LGA2011 Socket R (Primary CPU)
34	DIMM_P0_D0	Channel 4 slot (for primary CPU)
35	DIMM_P0_C0	Channel 3 slot (for primary CPU)
36	LAN3_LED	LAN #3 Active/Link connector
37	LAN4_LED	LAN #4 Active/Link connector
38	FP_1	Front panel header
39	SAS0~7	SAS 6Gb/s connectors (Gigabyte extension card required)
40	RAID_SLOT2	PCI Express x4 slot (Proprietary slot)
41	SAS_SGP2	SAS SGPIO header#2

42	SAS_SGP1	SAS SGPIO header#1
43	IPMB	IPMB connector
44	RAID_SLOT1	PCI Express x8 slot
45	COM2	Serial port cable connector
46	PCIE_1	PCI Express x16 slot (GEN3/Running at x4)
47	PCIE_2	PCI Express x16 slot (GEN3/Running at x4)
48	PCIE_3	PCI Express x16 slot
49	PCIE_4	PCI Express x16 slot (GEN3/Running at x8)
50	PCIE_5	PCI Express x16 slot (GEN3/Running at x8)
51	PCIE_6	PCI Express x16 slot
52	TPM	TPM module connector
53	CLR_CMOS	Clear CMOS jumper
54	BAT	Battery socket
55	BMC_FRB	Force to Stop FRB Timer jumper
56	LED_BMC	BMC firmware readiness LED
57	BUZZER1	Buzzer

4-2 Jumper Setting

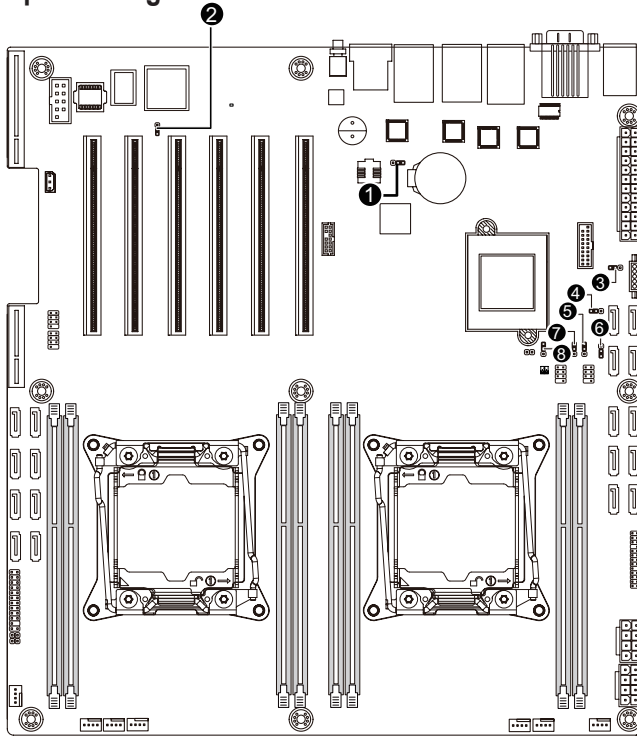

No.	Jumper Code	Jumper Setting								
1.	CLR_CMOS (Clearing CMOS Jumper)	1-2 Close: Normal operation (Default setting)								
		2-3 Close: Clear CMOS data								
2.	BMC_FRB (Force to Stop FRB Timer Jumper)	1-2 Close: Normal operation (Default setting)								
		2-3 Close: Force to Stop FRB Timer								
3.	SATA_DOM1 (SATA 1 DOM Jumper)	<table border="1"> <thead> <tr> <th>Pin No.</th> <th>Definition</th> </tr> </thead> <tbody> <tr> <td>1</td> <td>P5V</td> </tr> <tr> <td>2</td> <td>SATA1 Pin7</td> </tr> <tr> <td>3</td> <td>GND</td> </tr> </tbody> </table>	Pin No.	Definition	1	P5V	2	SATA1 Pin7	3	GND
		Pin No.	Definition							
		1	P5V							
		2	SATA1 Pin7							
3	GND									
1-2 Close: Normal operation. (Default setting)										
2-3 Close: Skip supervisor password.										
4.	BIOS_PWD (Clearing Supervisor Password Jumper)	1-2 Close: Normal operation. (Default setting)								
		2-3 Close: Skip supervisor password.								



CAUTION! If a SATA type hard drive is connected to the system, please ensure the jumper is closed and set to **2-3 pins** (Normal mode), in order to reduce any risk of hard disk damage.

5.	ME_UPDATE (ME Update Jumper)	1-2 Close: Normal operation (Default setting)
		2-3 Close: ME recovery mode.
6.	S3_MASK (S3 Power On Select Jumper)	1-2 Close: Stop an initial power on when BMC is not ready.
		2-3 Close: Keep initial power on. (Default setting)
7.	ME_RCVR (ME Recovery Jumper)	1-2 Close: Normal operation (Default setting)
		2-3 Close: ME recovery mode.
8.	BIOS_RCVR (BIOS Recovery Jumper)	1-2 Close: Normal operation (Default setting)
		2-3 Close: BIOS recovery mode.

Chapter 5 BIOS Setup

BIOS (Basic Input and Output System) records hardware parameters of the system in the EFI on the motherboard. Its major functions include conducting the Power-On Self-Test (POST) during system startup, saving system parameters and loading operating system, etc. BIOS includes a BIOS Setup program that allows the user to modify basic system configuration settings or to activate certain system features. When the power is turned off, the battery on the motherboard supplies the necessary power to the CMOS to keep the configuration values in the CMOS.

To access the BIOS Setup program, press the <F2> key during the POST when the power is turned on.



- BIOS flashing is potentially risky, if you do not encounter problems of using the current BIOS version, it is recommended that you don't flash the BIOS. To flash the BIOS, do it with caution. Inadequate BIOS flashing may result in system malfunction.
- It is recommended that you not alter the default settings (unless you need to) to prevent system instability or other unexpected results. Inadequately altering the settings may result in system's failure to boot. If this occurs, try to clear the CMOS values and reset the board to default values. (Refer to the **Exit** section in this chapter or introductions of the battery/clearing CMOS jumper in Chapter 1 for how to clear the CMOS values.)

BIOS Setup Program Function Keys

<<-><->>	Move the selection bar to select the screen
<↑><↓>	Move the selection bar to select an item
<+>	Increase the numeric value or make changes
<->	Decrease the numeric value or make changes
<Enter>	Execute command or enter the submenu
<Esc>	Main Menu: Exit the BIOS Setup program Submenus: Exit current submenu
<F1>	Show descriptions of general help
<F3>	Restore the previous BIOS settings for the current submenus
<F9>	Load the Optimized BIOS default settings for the current submenus
<F10>	Save all the changes and exit the BIOS Setup program

■ **Main**

This setup page includes all the items in standard compatible BIOS.

■ **Advanced**

This setup page includes all the items of AMI BIOS special enhanced features.

(ex: Auto detect fan and temperature status, automatically configure hard disk parameters.)

■ **Intel RC Setup**

This setup page includes all the submenu options for configuring the function of processor, network, North Bridge, South Bridge, and System event logs.

■ **Server Management**

Server additional features enabled/disabled setup menus.

■ **Security**

Change, set, or disable supervisor and user password. Configuration supervisor password allows you to restrict access to the system and BIOS Setup.

A supervisor password allows you to make changes in BIOS Setup.

A user password only allows you to view the BIOS settings but not to make changes.

■ **Boot**

This setup page provides items for configuration of boot sequence.

■ **Exit**

Save all the changes made in the BIOS Setup program to the CMOS and exit BIOS Setup. (Pressing <F10> can also carry out this task.)

Abandon all changes and the previous settings remain in effect. Pressing <Y> to the confirmation message will exit BIOS Setup. (Pressing <Esc> can also carry out this task.)

5-1 The Main Menu

Once you enter the BIOS Setup program, the Main Menu (as shown below) appears on the screen. Use arrow keys to move among the items and press <Enter> to accept or enter other sub-menu.

Main Menu Help

The on-screen description of a highlighted setup option is displayed on the bottom line of the Main Menu.

Submenu Help

While in a submenu, press <F1> to display a help screen (General Help) of function keys available for the menu. Press <Esc> to exit the help screen. Help for each item is in the Item Help block on the right side of the submenu.



- When the system is not stable as usual, select the **Restore Defaults** item to set your system to its defaults.
- The BIOS Setup menus described in this chapter are for reference only and may differ by BIOS version.

```
Bios Setup Utility
Main Advanced IntelRCSetup Server Mgmt Security Boot Save & Exit

BIOS Information
Project Name                R260-R3C
Project Version             F01
Build Date and Time         07/09/2014 16:26:32

BMC Information
BMC Firmware Version        01.60
SDR Revision                 00.02
FRU Version                  01.00

Processor Information
CPU 0 Brand String          Intel(R) Xeon(R) CPU E5-2690
CPU 1 Brand String          Intel(R) Xeon(R) CPU E5-2690
Max CPU Speed                2600 MHz
CPU Signature                306F2
Processor Core               24
Microcode Patch              0000001F

Memory Information
Total Memory                 16384 MB
Memory Frequency             2133 MHz

Onboard LAN Information
LAN1 MAC Address             74-04-35-E9-DB-06
LAN2 MAC Address             74-04-35-E9-DB-07

+/: Select Screen
F1: Select Item
Enter: Select
+/-: Change Opt.
F1: General Help
F3: Previous Values
F9: Optimized Defaults
F10: Save & Exit
ESC: Exit
```

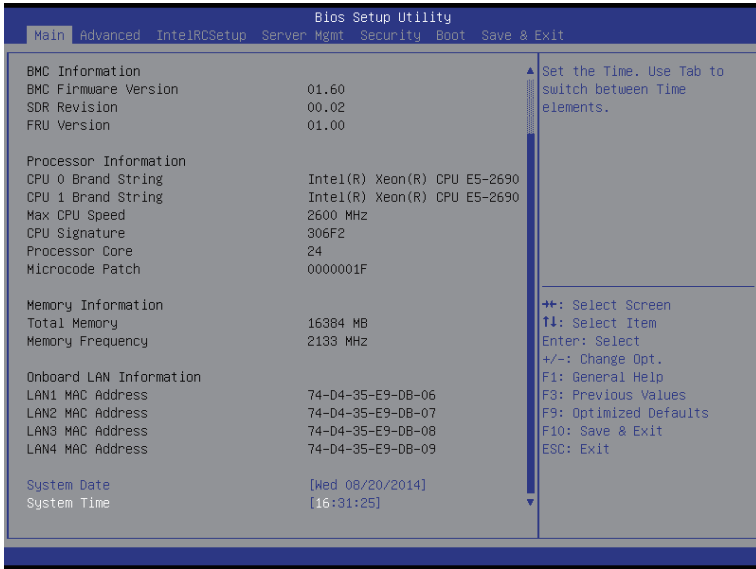
🔗 **BIOS Information**

🔗 **Project Name**

Display the project name information.

🔗 **Project Version**

Display version number of the BIOS setup utility.

🔗 **BIOS Build Date and Time**

Displays the date and time when the BIOS setup utility was created.

🔗 **BMC Information**

🔗 **BMC Firmware Version**

Display version number of the Firmware setup utility.

🔗 **SDR Reversion**

Display the SDR revision information.

🔗 **FRU Version**

Display the FRU version information.

🔗 **Processor Information**

🔗 **CPU Brand String/Max CPU Speed/CPU Signature/Processors Core/Microcode Patch**

Displays the technical specifications for the installed processor.

🔗 **Memory Information**

🔗 **Total Memory**

Display the total memory size of the installed memory.

🔗 **Memory Frequency**

Display the frequency information of the installed memory.

☞ **Onboard LAN Information**

☞ **LAN1/LAN2/LAN3/LAN4 MAC Address**

Display LAN1/LAN2/LAN3/LAN4 MAC address information.

☞ **System Date**

Set the date following the weekday-month-day- year format.

☞ **System Time**

Set the system time following the hour-minute- second format.

5-2 Advanced Menu

The Advanced menu display submenu options for configuring the function of various hardware components. Select a submenu item, then press Enter to access the related submenu screen.

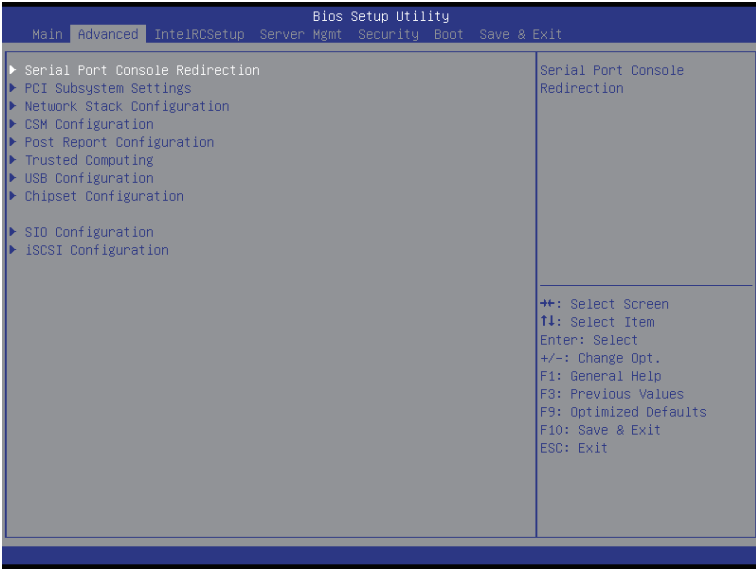

5-2-1 Serial Port Console Redirection

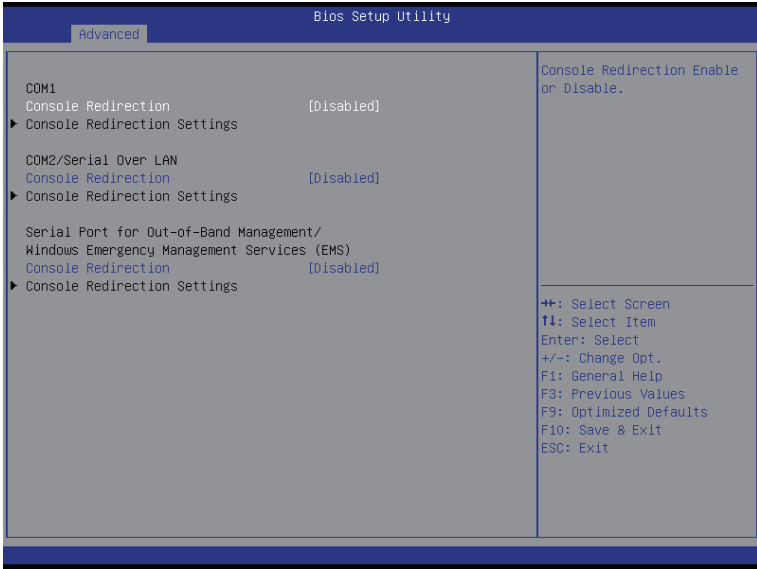

Bios Setup Utility		
Advanced		
CDM2/Serial Over LAN		Emulation: ANSI: Extended ASCII char set. VT100: ASCII char set. VT100+: Extends VT100 to support color, function keys, etc. VT-UTF8: Uses UTF8 encoding to map Unicode chars onto 1 or more bytes.
Console Redirection Settings		
Terminal Type	[ANSI]	++: Select Screen T4: Select Item Enter: Select +/-: Change Opt. F1: General Help F3: Previous Values F9: Optimized Defaults F10: Save & Exit ESC: Exit
Bits per second	[115200]	
Data Bits	[8]	
Parity	[None]	
Stop Bits	[1]	
Flow Control	[None]	
VT-UTF8 Combo Key Support	[Enabled]	
Recorder Mode	[Disabled]	
Resolution 100x31	[Enabled]	
Legacy OS Redirection Resolution	[80x24]	
Putty KeyPad	[VT100]	
Redirection After BIOS POST	[Always Enable]	

Bios Setup Utility		
Advanced		
Out-of-Band Mgmt Port	[COM1]	Microsoft Windows Emergency Management Services (EMS) allows for remote management of a Windows Server OS through a serial port.
Terminal Type	[VT-UTF8]	
Bits per second	[115200]	++: Select Screen T4: Select Item Enter: Select +/-: Change Opt. F1: General Help F3: Previous Values F9: Optimized Defaults F10: Save & Exit ESC: Exit
Flow Control	[None]	
Data Bits	8	
Parity	None	
Stop Bits	1	

☞ **COM1/COM2/Serial Over AN Console Redirection Settings**

☞ **Console Redirection** (Note)

Select whether to enable console redirection for specified device. Console redirection enables users to manage the system from a remote location.

Options available: Enabled/Disabled. Default setting is **Disabled**.

☞ **Console Redirection Settings**

☞ **Terminal Type**

Select a terminal type to be used for console redirection.

Options available: VT100/VT100+/ANSI /VT-UTF8. Default setting is **ANSI**.

☞ **Bits per second**

Select the baud rate for console redirection.

Options available: 9600/19200/57600/115200. Default setting is **115200**.

☞ **Data Bits**

Select the data bits for console redirection.

Options available: 7/8. Default setting is **8**.

☞ **Parity**

A parity bit can be sent with the data bits to detect some transmission errors.

Even: parity bit is 0 if the num of 1's in the data bits is even.

Odd: parity bit is 0 if num of 1's in the data bits is odd.

Mark: parity bit is always 1. Space: Parity bit is always 0.

Mark and Space Parity do not allow for error detection.

Options available: None/Even/Odd/Mark/Space. Default setting is **None**.

☞ **Stop Bits**

Stop bits indicate the end of a serial data packet. (A start bit indicates the beginning). The standard setting is 1 stop bit. Communication with slow devices may require more than 1 stop bit.

Options available: 1/2. Default setting is **1**.

☞ **Flow Control**

Flow control can prevent data loss from buffer overflow. When sending data, if the receiving buffers are full, a 'stop' signal can be sent to stop the data flow. Once the buffers are empty, a 'start' signal can be sent to re-start the flow. Hardware flow control uses two wires to send start/stop signals.

Options available: None/Hardware RTS/CTS. Default setting is **None**.

☞ **VT-UTF8 Combo Key Support** (Note)

Enable/Disable VT-UTF8 Combo Key Support.

Options available: Enabled/Disabled. Default setting is **Enabled**.

☞ **Recorder Mode** (Note)

When this mode enabled, only text will be send. This is to capture Terminal data.

Options available: Enabled/Disabled. Default setting is **Disabled**.

☞ **Resolution 100x31** (Note)

Enables or disables extended terminal resolution. Default setting is **Enabled**.

Options available: Enabled/Disabled.

(Note) Advanced items prompt when this item is defined.

☞ **Legacy OS Redirection Resolution** (Note)

On Legacy OS, the number of Rows and Columns supported redirection.

Options available: 80x24/80X25. Default setting is **80x24**.

☞ **Putty KeyPad** (Note)

Select function FunctionKey and KeyPad on Putty.

Options available: VT100/LINUX/XTERMR6/SCO/ESCN/VT400. Default setting is **VT100**.

☞ **Redirection After BIOS POST** (Note)

This option allows user to enable console redirection after O.S has loaded.

Options available: Always Enable/Boot Loader. Default setting is **Always Enable**.

☞ **Out-of-Bnad Mgmt Port**

Microsoft Windows Emergency Management Service (EMS) allows for remote management of a Windows Server OS through a serial port.

Options available: COM1/COM2. Default setting is **COM1**.

(Note) Advanced items prompt when this item is defined.

5-2-2 PCI Subsystem Settings



☞ PCI Express Slot #1/#2/#3/#4/#5/#6/#7 I/O ROM

When enabled, This setting will initialize the device expansion ROM for the related PCI-E slot.
Options available: Enabled/Disabled. Default setting is **Enabled**.

☞ Onboard LAN#1/#2/#3/#4 Controller

Enable/Disable onboard LAN devices.
Options available: Enabled/Disabled. Default setting is **Enabled**.

☞ Onboard LAN #1/#2/#3/#4 I/O ROM

Enable/Disable onboard LAN devices and initialize device expansion ROM.
Options available: Enabled/Disabled. Default setting is **Enabled**.

☞ PCI Devices Common Settings

☞ PCI Latency Timer

Value to be programmed into PCI Latency Timer Register.
Options available: 32 PCI Bus Clocks/64 PCI Bus Clocks/96 PCI Bus Clocks/128 PCI Bus Clocks/160 PCI Bus Clocks/192 PCI Bus Clocks/224 PCI Bus Clocks/248 PCI Bus Clocks/.
Default setting is **32 PCI Bus Clocks**.

☞ VGA Palette Snoop

Enable/Disable VGA Palette Registers Snooping.
Options available: Enabled/Disabled. Default setting is **Disabled**.

☞ Above 4G Decoding

Enable/Disable Above 4G Decoding.
Options available: Enabled/Disabled. Default setting is **Disabled**.

☞ **SR-IOV Support**

If system has SR-IOV capable PCIe Devices, this option enables or disables Single Root IO Virtualization Support.

Options available: Enabled/Disabled. Default setting is **Disabled**.

☞ **PCI Express Settings**

Press [Enter] for configuration of advanced items.

5-2-2-1 PCI Express Settings

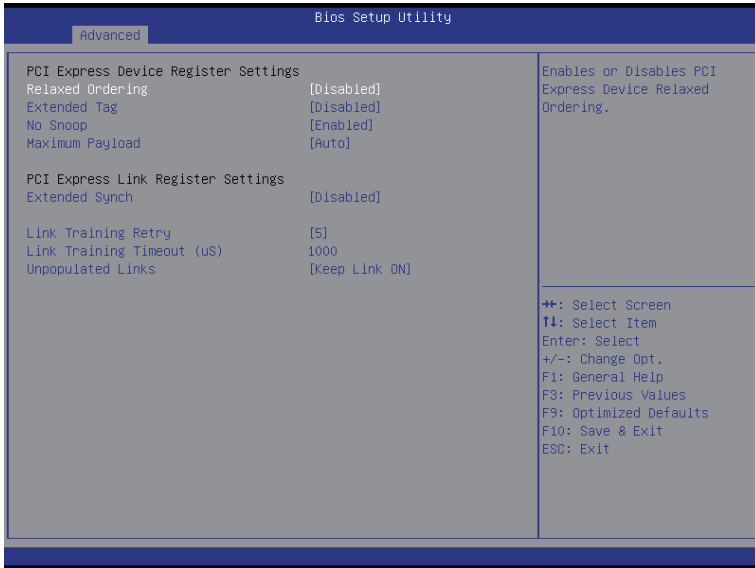

☞ PCI Express Device Register Settings

☞ Relaxed Ordering

Enable/Disable PCI Express Device Relaxed Ordering feature.

Options available: Enabled/Disabled. Default setting is **Disabled**.

☞ Extended Tag

When this feature is enabled, the system will allow device to use 8-bit Tag field as a requester.

Options available: Enabled/Disabled. Default setting is **Disabled**.

☞ No Snoop

Enable/Disable PCI Express Device No Snoop option.

Options available: Enabled/Disabled. Default setting is **Enabled**.

☞ Maximum Payload

Set maximum payload for PCI Express Device or allow system BIOS to select the value.

Options available: Auto/128 Bytes/256 Bytes/512 Bytes/1024 Bytes/2048 Bytes/4096 Bytes.

Default setting is **Auto**.

☞ PCI Express Link Register Settings

☞ Extended Synch

When this feature is enabled, the system will allow generation of Extended Synchronization patterns.

Options available: Enabled/Disabled. Default setting is **Disabled**.

☞ Link Training Retry

Define the number of Retry Attempts software will take to retrain the link if previous training attempt was unsuccessful. Press <+> / <-> keys to increase or decrease the desired values.

☞ **Link Training Timeout (us)**

Define the number of Microseconds software will wait before polling 'Link Training' bit in Link Status register. Press <+> / <-> keys to increase or decrease the desired values. Value rang is from 10 to 10000 us.

☞ **Unpopulated Links**

When this item is set to 'Disable Link', the system will operate power save feature for those unpopulated PCI Express links.

Options available: Keep Link ON/ Disable Link. Default setting is **Keep Link ON**.

5-2-3 Network Stack



🔑 Network stack

Enable/Disable UEFI network stack.

Options available: Enabled/Disabled. Default setting is **Disabled**.

🔑 Ipv4 PXE Support^(Note)

Enable/Disable Ipv4 PXE feature.

Options available: Enabled/Disabled. Default setting is **Enabled**.

🔑 Ipv6 PXE Support^(Note)

Enable/Disable Ipv6 PXE feature.

Options available: Enabled/Disabled. Default setting is **Enabled**.

🔑 PXE boot wait time^(Note)

Press <+> / <-> keys to increase or decrease the desired values.

🔑 Media detect time^(Note)

Press <+> / <-> keys to increase or decrease the desired values.

(Note) This item appears when **Network Stack** is set to **Enabled**.

5-2-4 CSM Configuration

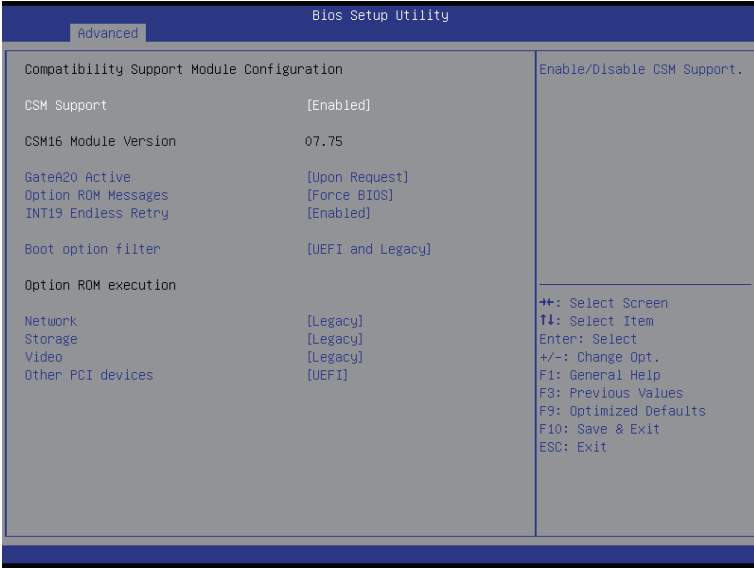

☞ Compatibility Support Module Configuration

☞ CSM Support

Enable/Disable Compatibility Support Module (CSM) support.

Options available: Enabled/Disabled. Default setting is **Enabled**.

☞ CSM16 Module Version

Display CSM Module version information.

☞ Gate20 Active

Upon Request: GA20 can be disabled using BIOS services.

Always: Do not allow disabling GA20; this option is useful when any RT code is executed above 1MB.

Options available: Upon Request/Always. Default setting is **Upon Request**.

☞ Option ROM Messages

Option ROM Messages.

Options available: Force BIOS/Keep Current. Default setting is **Force BIOS**.

☞ INT19 Endless Retry

Enabled: Allowed headless retry boot

Options available: Enabled/Disabled. Default setting is **Enabled**.

☞ Boot option filter

Determines which devices system will boot to.

Options available: UEFI and Legacy/Legacy only/UEFI only. Default setting is **UEFI and Legacy**.

☞ **Option ROM execution**

☞ **Network**

Controls the execution UEFI and Legacy PXE OpROM.

Options available: Do not launch/UEFI/Legacy. Default setting is **Legacy**.

☞ **Storage**

Controls the execution UEFI and Legacy Storage OpROM.

Options available: Do not launch/UEFI/Legacy. Default setting is **Legacy**.

☞ **Video**

Controls the execution UEFI and Legacy Video OpROM.

Options available: Do not launch/UEFI/Legacy. Default setting is **Legacy**.

☞ **Other PCI devices**

Determines OpROM execution policy for devices other than network, Storage, or Video.

Options available: UEFI/Legacy. Default setting is **UEFI**.

5-2-5 Post Report Configuration



☞ **Post Report Configuration**

☞ **Error Message Report**

☞ **Post Error Message**

Enable/Disable Info Error Message support.

Options available: Enabled/Disabled. Default setting is **Enabled**.

5-2-6 Trusted Computing

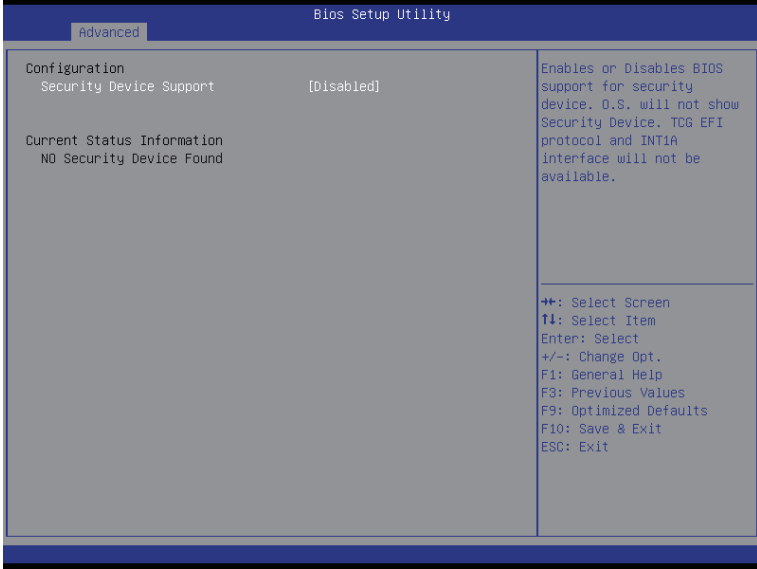

⌄ Configuration

⌄ Security Device Support

Select Enabled to activate TPM support feature.

Options available: Enabled/Disabled. Default setting is **Disabled**.

⌄ Current Status Information

Display current TPM status information.

5-2-7 USB Configuration



☞ USB Configuration

☞ USB Devices:

Display the USB devices connected to the system.

☞ XHCI Hand-off

Enable/Disable XHCI (USB 3.0) Hand-off support.

Options available: Enabled/Disabled. Default setting is **Enabled**.

☞ EHCI Hand-off

Enable/Disable EHCI (USB 2.0) Hand-off function.

Options available: Enabled/Disabled. Default setting is **Disabled**.

☞ USB Mass Storage Driver Support^(Note)

Enable/Disable USB Mass Storage Driver Support.

Options available: Enabled/Disabled. Default setting is **Enabled**.

☞ Port 60/64 Emulation

Enable I/O port 60h/64h emulation support. This should be enabled for the complete USB Keyboard Legacy support for non-USB aware OS.

Options available: Enabled/Disabled. Default setting is **Enabled**.

(Note) This item is present only if you attach USB types of device.

5-2-8 Chipset Configuration

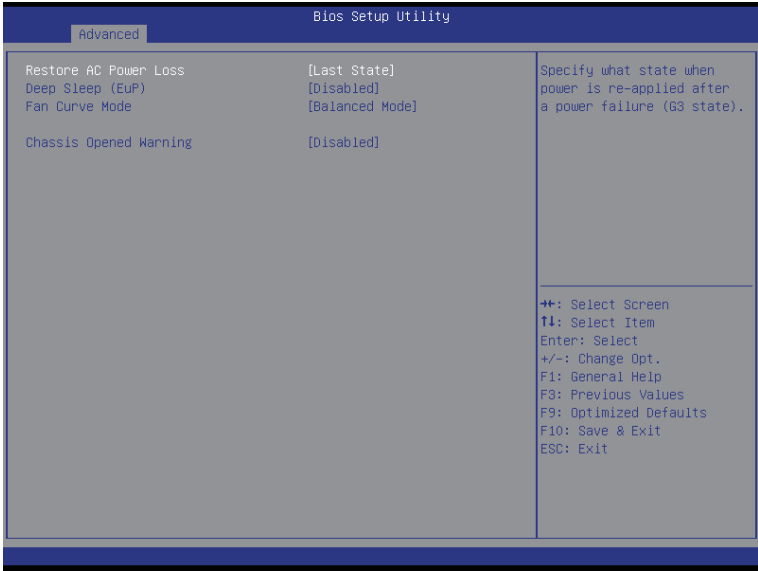

☞ **Restore on AC Power Loss** ^(Note)

Defines the power state to resume to after a system shutdown that is due to an interruption in AC power. When set to Last State, the system will return to the active power state prior to shutdown. When set to Stay Off, the system remains off after power shutdown.

Options available: Last State/Stay Off/Power On. The default setting depends on the BMC setting.

☞ **Deep Sleep (EuP)**

Enable/Disable Deep Sleep mode.

Options available: Enabled/Disabled. Default setting is **Disabled**.

☞ **Fan Curve Mode**

Configure system fan curve mode

Options available: Full Dpeed Mode/Performance ModeBalanced mode/Energy Saving Mode.

Default setting is **Performance Mode**.

☞ **Chassis Opened Warning**

Enable/Disable Chassis intrusion alter funtion.

Options available: Enabled/Disabled. Default setting is **Disabled**.

(Note) When the power policy is controlled by BMC, please wait for 15-20 seconds for BMC to save the last power state.

5-9 SIO Configuration

Bios Setup Utility	
Advanced	
<p>AMI SIO Driver Version : GSI0010A5.03.04</p> <p>Super IO Chip Logical Device(s) Configuration</p> <ul style="list-style-type: none"> ▶ [*Active*] Serial Port 1 ▶ [*Active*] Serial Port 2 ▶ [*Active*] PS2 Keyboard ▶ [*Active*] PS2 Mouse <p>WARNING: Logical Devices state showing at the left side of the controll, reflects current Logical Device state. Cahnges made during Setup Session will be shown after you restart the system.</p>	<p>View and Set Basic properties of the SIO Logical device. Like IO Base, IRQ Range, DMA Channel and Device Mode.</p> <hr/> <p> ++: Select Screen ↑↓: Select Item Enter: Select +/-: Change Opt. F1: General Help F3: Previous Values F9: Optimized Defaults F10: Save & Exit ESC: Exit </p>

Bios Setup Utility	
Advanced	
<p>Serial Port 1 Configuration</p> <p>Use This DeviceGSI0011 [Enabled]</p> <p>Logical Device Settings: Current : IO=3F6h; IRQ=4;</p> <p>Possible: [Use Automatic Settings]</p> <p>WARNING: disabling SIO Logical Devices may have unwanted side effects. PROCEED WITH CAUTION.</p>	<p>Enable or Disable this Logical Devcie.</p> <hr/> <p> ++: Select Screen ↑↓: Select Item Enter: Select +/-: Change Opt. F1: General Help F3: Previous Values F9: Optimized Defaults F10: Save & Exit ESC: Exit </p>

Bios Setup Utility	
Advanced	
<p>Serial Port 2 Configuration</p> <p>Use This Device6SI0011 [Enabled]</p> <p>Logical Device Settings: Current : IO=2F8h; IRQ=3;</p> <p>Possible: [Use Automatic Settings]</p> <p>WARNING: disabling SIO Logical Devices may have unwanted side effects. PROCEED WITH CAUTION.</p>	<p>Enable or Disable this Logical Device.</p> <hr/> <p> ++: Select Screen ↑↓: Select Item Enter: Select +/-: Change Opt. F1: General Help F8: Previous Values F9: Optimized Defaults F10: Save & Exit ESC: Exit </p>

Bios Setup Utility	
Advanced	
<p>PS2 Keyboard Configuration</p> <p>Logical Device Settings: Current : IO=60h; IO=64h; IRQ=1;</p> <p>Possible: [Use Automatic Settings]</p> <p>WARNING: disabling SIO Logical Devices may have unwanted side effects. PROCEED WITH CAUTION.</p>	<p>Allows user to change Device's Resource settings. New settings will be reflected on This Setup Page after System restarts.</p> <hr/> <p> ++: Select Screen ↑↓: Select Item Enter: Select +/-: Change Opt. F1: General Help F8: Previous Values F9: Optimized Defaults F10: Save & Exit ESC: Exit </p>

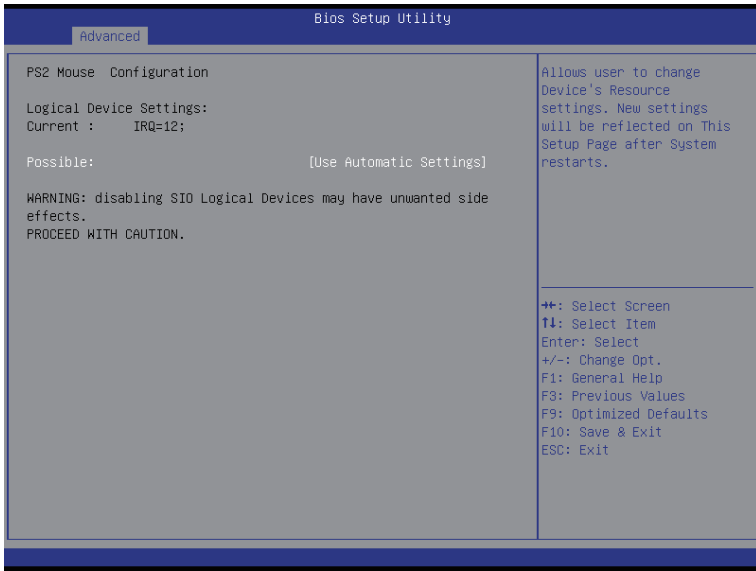

☞ **AMI SIO Driver Version**

Display the AMI SIO driver version information.

☞ **Super IO Chip Logical Device(s) Configuration**

☞ **[*Active*] Serial Port 1/2**

Press [Enter] for configuration of advanced items.

☞ **[*Active*] PS2 Keyboard**

Press [Enter] for configuration of advanced items.

☞ **[*Active*] PS2 Mouse**

Press [Enter] for configuration of advanced items.

☞ **Serial Port 1 Configuration**

☞ **Use This Device**

When enabled allows you to configure the serial port 1 settings. When set to Disabled, displays no configuration for the serial port.

Options available: Enabled/Disabled. Default setting is **Enabled**.

☞ **Logical Device Settings:**

☞ **Current:**

Display the Serial Port 1 base I/O address and IRQ.

☞ **Possible:**

Configure Serial Port 1 base I/O address and IRQ.

Option available:

Use Automatic Settings

IO=3F8h; IRQ=4; DMA;/

IO=3F8h; IRQ=3,4,5,7,9,10,11,12; DMA;/

IO=2F8h; IRQ=3,4,5,7,9,10,11,12; DMA;/

IO=3E8h; IRQ=3,4,5,7,9,10,11,12; DMA;/

IO=2E8h; IRQ=3,4,5,7,9,10,11,12; DMA;

Default setting is **Use Automatic Settings**.

☞ **Serial Port 2 Configuration**

☞ **Use This Device**

When enabled allows you to configure the serial port 2 settings. When set to Disabled, displays no configuration for the serial port.

Options available: Enabled/Disabled. Default setting is **Enabled**.

☞ **Logical Device Settings:**

☞ **Current:**

Display the Serial Port 2 base I/O address and IRQ.

☞ **Possible:**

Configure Serial Port 2 base I/O address and IRQ.

Option available:

Use Automatic Settings/

IO=2F8h; IRQ=3; DMA;/

IO=3F8h; IRQ=3,4,5,7,9,10,11,12; DMA;/

IO=2F8h; IRQ=3,4,5,7,9,10,11,12; DMA;/

IO=3E8h; IRQ=3,4,5,7,9,10,11,12; DMA;/

IO=2E8h; IRQ=3,4,5,7,9,10,11,12; DMA;/

Default setting is **Use Automatic Settings**.

☞ **PS2 Keyboard Configuration**

☞ **Logical Device Settings:**

☞ **Current:**

Display the PS2 keyboard base I/O address and IRQ.

☞ **Possible:**

Configure PS2 keyboard base I/O address and IRQ.

Option available: Use Automatic Settings/IO=60h; IO=64h; IRQ=1.

Default setting is **Use Automatic Settings**.

☞ **PS2 Mouse Configuration**

☞ **Logical Device Settings:**

☞ **Current:**

Display the PS2 mouse base I/O address and IRQ.

☞ **Possible:**

Configure PS2 mouse base I/O address and IRQ.

Option available: Use Automatic Settings/IRQ=12;. Default setting is **Use Automatic Settings**.

5-2-10 iSCSI Configuration



☞ **iSCSI Initiator Name**

☞ **Add an Attempts**

Press [Enter] for configuration of advanced items.

☞ **Delete Attempts**

Press [Enter] for configuration of advanced items.

☞ **Change Attempt Order**

Press [Enter] for configuration of advanced items.

5-3 Intel RC Setup Menu

Intel RC Setup menu displays submenu options for configuring the function of North Bridge and South Bridge. Select a submenu item, then press Enter to access the related submenu screen.

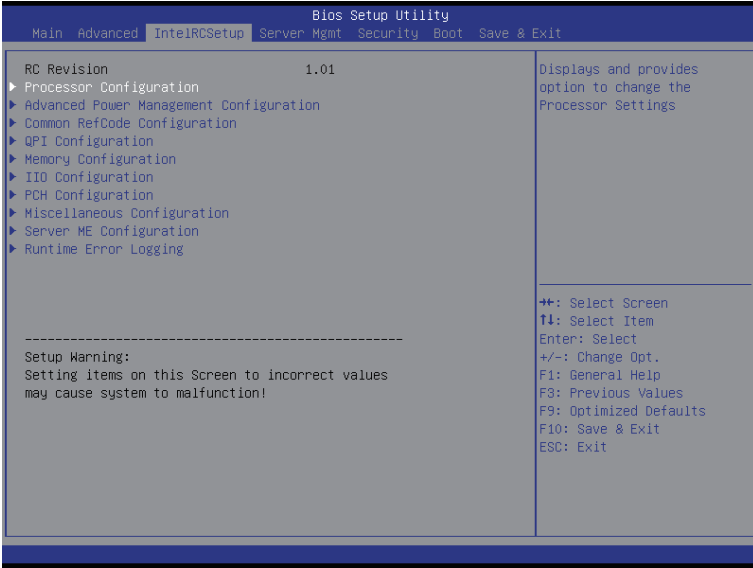

RC Revision

Display Intel RC version information.

5-3-1 Processor Configuration

Bios Setup Utility

InteIRCSetup

Processor Configuration		Change Per-Socket Settings

▶ Per-Socket Configuration		
Processor Socket	Socket 0	Socket 1
Processor ID	000306F2*	000306F2
Processor Frequency	2.600GHz	2.600GHz
Processor Max Ratio	1AH	1AH
Processor Min Ratio	0CH	0CH
Microcode Revision	0000001F	0000001F
L1 Cache RAM	768KB	768KB
L2 Cache RAM	3072KB	3072KB
L3 Cache RAM	30720KB	30720KB
Processor 0 Version	Intel(R) Xeon(R) CPU E5 -2690 v3 @ 2.60GHz	
Processor 1 Version	Intel(R) Xeon(R) CPU E5 -2690 v3 @ 2.60GHz	
Hyper-Threading [ALL]	[Enable]	
Execute Disable Bit	[Enable]	
Enable Intel TXT Support	[Disable]	
VMX	[Enable]	
Enable SMX	[Disable]	
Hardware Prefetcher	[Enable]	
Adjacent Cache Prefetch	[Enable]	
DCU Streamer Prefetcher	[Enable]	
++: Select Screen ↑↓: Select Item Enter: Select +/-: Change Opt. F1: General Help F3: Previous Values F9: Optimized Defaults F10: Save & Exit ESC: Exit		

Bios Setup Utility

InteIRCSetup

Processor Max Ratio	1AH	1AH	▲ Enable/disable AES-NI support ++: Select Screen ↑↓: Select Item Enter: Select +/-: Change Opt. F1: General Help F3: Previous Values F9: Optimized Defaults F10: Save & Exit ESC: Exit
Processor Min Ratio	0CH	0CH	
Microcode Revision	0000001F	0000001F	
L1 Cache RAM	768KB	768KB	
L2 Cache RAM	3072KB	3072KB	
L3 Cache RAM	30720KB	30720KB	
Processor 0 Version	Intel(R) Xeon(R) CPU E5 -2690 v3 @ 2.60GHz		
Processor 1 Version	Intel(R) Xeon(R) CPU E5 -2690 v3 @ 2.60GHz		
Hyper-Threading [ALL]	[Enable]		
Execute Disable Bit	[Enable]		
Enable Intel TXT Support	[Disable]		
VMX	[Enable]		
Enable SMX	[Disable]		
Hardware Prefetcher	[Enable]		
Adjacent Cache Prefetch	[Enable]		
DCU Streamer Prefetcher	[Enable]		
DCU IP Prefetcher	[Enable]		
DCU Mode	[32KB 8Way Without ECC]		
Direct Cache Access (DCA)	[Auto]		
DCA Prefetch Delay	[32]		
X2APIC	[Disable]		
AES-NI	[Enable]		

☞ Processor Configuration

☞ Pre-Socket Configuration

Press [Enter] for configuration of advanced items.

☞ Processor Socket/Processor ID/Processor Frequency/Processor Max Raito/ Processor Min Raio/Microcode Revision/L1 Cache RAM/L2 Cache RAM/L3 Cache RAM/ Processor 0/1Version

Displays the technical specifications for the installed processor.

☞ Hyper-Threading [All]

The Hyper Threading Technology allows a single processor to execute two or more separate threads concurrently. When hyper-threading is enabled, multi-threaded software applications can execute their threads, thereby improving performance.

Options available: Enabled/Disabled. Default setting is **Enabled**.

☞ Execute Disable Bit

When enabled, the processor prevents the execution of code in data-only memory pages. This provides some protection against buffer overflow attacks.

When disabled, the processor will not restrict code execution in any memory area. This makes the processor more vulnerable to buffer overflow attacks.

Options available: Enabled/Disabled. Default setting is **Enabled**.

☞ Enable Intel TXT Support

Enable/Disable Intel Trusted Execution Technology support function.

Options available: Enabled/Disabled. Default setting is **Disabled**.

☞ VMX (Vanderpool Technology)

Enable/Disable Vanderpool Technology. This will take effect after rebooting the system.

Options available: Enabled/Disabled. Default setting is **Enabled**.

☞ Enable SMX (Intel Safer Mode Extensions Technology)

Enable/Disbla Intel Safer Mode Extensions (SMX) support function.

Options available: Enabled/Disabled. Default setting is **Disabled**.

☞ Hardware Prefetcher

Select whether to enable the speculative prefetch unit of the processor.

Options available: Enabled/Disabled. Default setting is **Enabled**.

☞ Adjacent Cache Line Prefetch

When enabled, cache lines are fetched in pairs. When disabled, only the required cache line is fetched.

Options available: Enabled/Disabled. Default setting is **Enabled**.

☞ DCU Streamer Prefetch

Enable prefetch of next L1 Data line based upon multiple loads in same cache line.

Options available: Enabled/Disabled. Default setting is **Enabled**.

☞ DCU IP Prefetch

Enable prefetch of next L1 Data line based upon sequential load history.

Options available: Enabled/Disabled. Default setting is **Enabled**.

☞ DCU Mode

Configure DCU mode.

Options available: 32KB 8Way Without ECC/16KB 4Way With ECC. Default setting is **32KB 8Way Without ECC**.

☞ **Direct Cache Access (DCA)**

Options available: Auto/Enabled/Disabled. Default setting is **Auto**.

☞ **DCA Prefetch Delay**

Options available: Disabled/8/16/24/32/40/48/56/64/72/80/88/96/104/112. Default setting is **32**.

☞ **X2APIC**

Options available: Enabled/Disabled. Default setting is **Disabled**.

☞ **AES-NI**

Enable/Disable AES-NI (Intel Advanced Encryption Standard New Instructions) support function.

Options available: Enabled/Disabled. Default setting is **Enabled**.

5-3-1-1 Pre-Socket Configuration

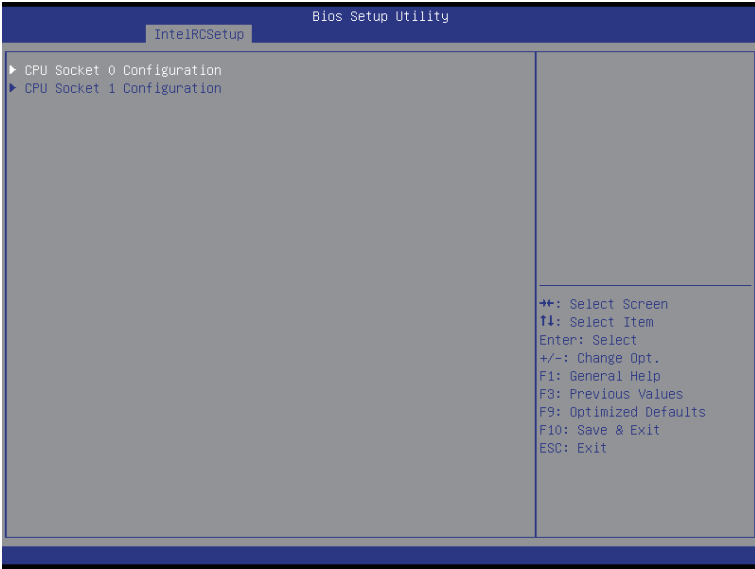



☞ **CPU Socket 0/1 Configuration**

Press [Enter] for configuration of advanced items.

☞ **Cores Enabled (for CPU socket 0/1)**

Number of Cores to enable. 0 means all cores. 14 Cores is available. Press <+> and <-> keys to adjust desired values.

5-3-2 Advanced Power Management Configuration



☞ Advanced Power Management Configuration

☞ Power Technology

Option available: Disabled/Energy Efficient/Custom. Default setting is **Energy Efficient**.

☞ Config TDP

Options available: Enabled/Disabled. Default setting is **Disabled**.

☞ Config TDP Level^(Note)

Options available: Nominal. Default setting is **Nominal**.

☞ CPU P State Control^(Note)

Press [Enter] for configuration of advanced items.

☞ CPU C State Control^(Note)

Press [Enter] for configuration of advanced items.

☞ CPU T State Control^(Note)

Press [Enter] for configuration of advanced items.

(Note) This item appears when **Config TDP** is set to **Enabled**.

5-3-2-1 CPU P State Control



☞ EIST (P-State)

Conventional Intel SpeedStep Technology switches both voltage and frequency in tandem between high and low levels in response to processor load.

Options available: Enabled/Disabled. Default setting is **Enabled**.

☞ Turbo Mode

When this item is enabled, the processor will automatically ramp up the clock speed of 1-2 of its processing cores to improve its performance.

When this item is disabled, the processor will not overclock any of its core.

Options available: Enabled/Disabled. Default setting is **Enabled**.

☞ P-state coordination

In HW_ALL mode, the processor hardware is responsible for coordinating the P-state among logical processors dependencies. The OS is responsible for keeping the P-state request up to date on all logical processors.

In SW_ALL mode, the OS Power Manager is responsible for coordinating the P-state among logical processors with dependencies and must initiate the transition on all of those Logical Processors.

In SW_ANY mode, the OS Power Manager is responsible for coordinating the P-state among logical processors with dependencies and may initiate the transition on any of those Logical Processors.

Options available: HW_ALL/SW_ALL/SW_ANY. Default setting is **HW_ALL**.

5-3-2-2 CPU C State Control

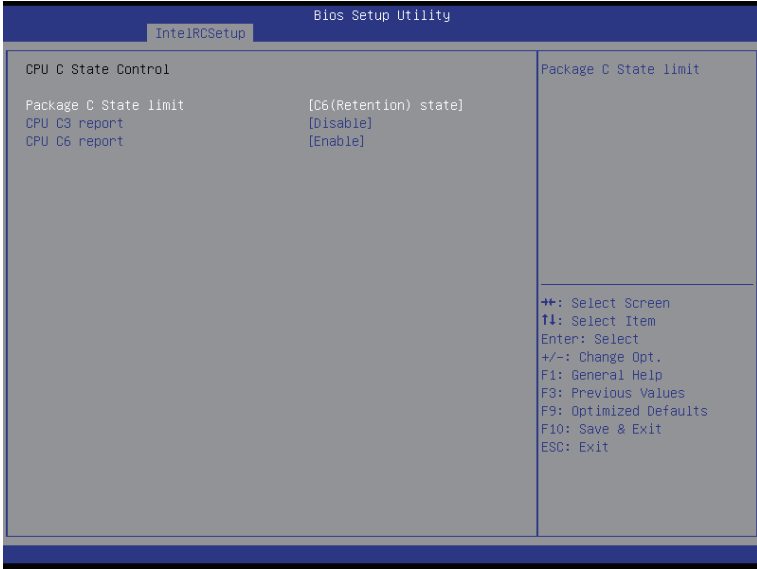

☞ Package C State Limit

Configure state for the C-State package limit.

Options available: C0/C1 state/C2 state/C6(non Retention) state/C6(Retention) state.

Default setting is **C6(non Retention) state**.

☞ CPU C3/C6 Report

Allows you to determine whether to let the CPU enter C3/C6 mode in system halt state. When enabled, the CPU core frequency and voltage will be reduced during system halt state to decrease power consumption. The C3/C6 state is a more enhanced power-saving state than C1.

Default setting for C3 is **Disabled**; default setting for C6 is **Enabled**.

5-3-2-3 CPU T State Control



☞ **ACPI T-States**

Enable/Disable CPU throttling by OS. Throttling reduces power consumption.

Options available: Enabled/Disabled. Default setting is **Enabled**.

5-3-3 Common RefCode Configuration



☞ **Common RefCode Configuration**

☞ **Isoc Mode**

Options available: Auto/Enabled/Disabled. Default setting is **Auto**.

☞ **Numa (Non-Uniform Memory Access)**

Options available: Enabled/Disabled. Default setting is **Enabled**.

5-3-4 QPI Configuration

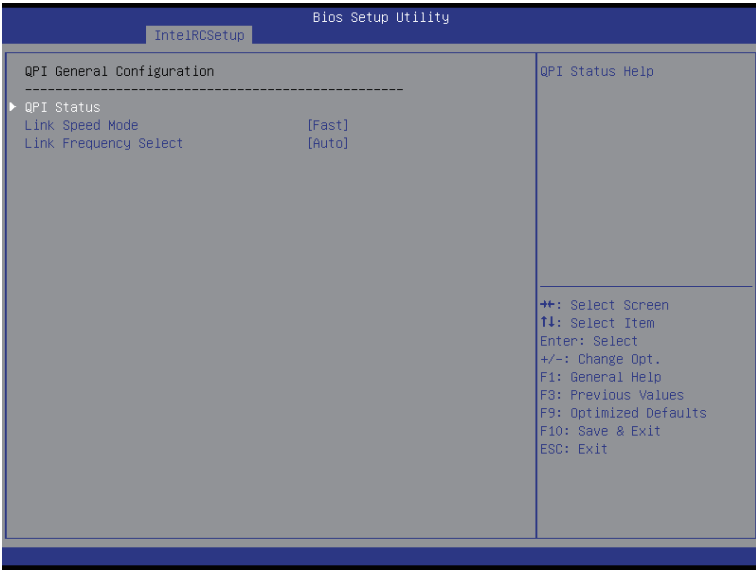
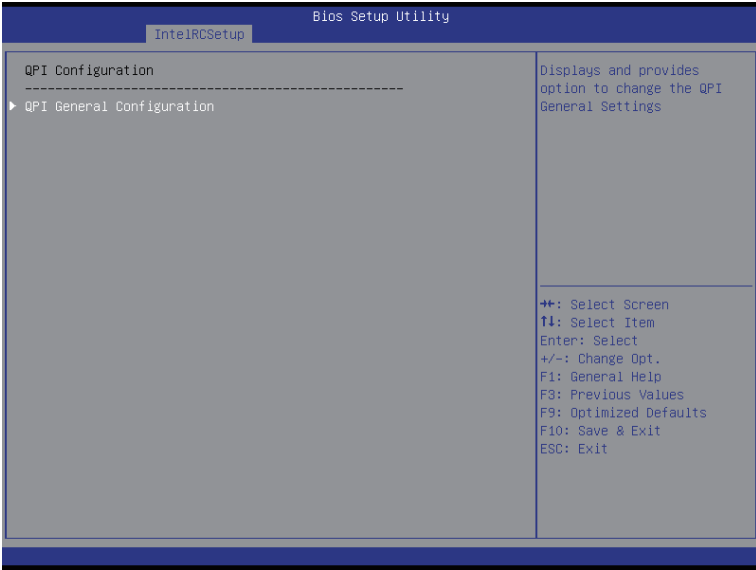



☞ QPI General Configuration

Press [Enter] for configuration of advanced items.

☞ QPI Status

Press [Enter] to view QPI status.

☞ Link Speed Mode

Options available: Slow/Fast. Default setting is **Fast**.

☞ Link Frequency Select

Options available: 6.4GB/s/8.0GB/s/9.6GB/s/Auto/Auto Limited. Default setting is **Auto**.

5-3-5 Memory Configuration

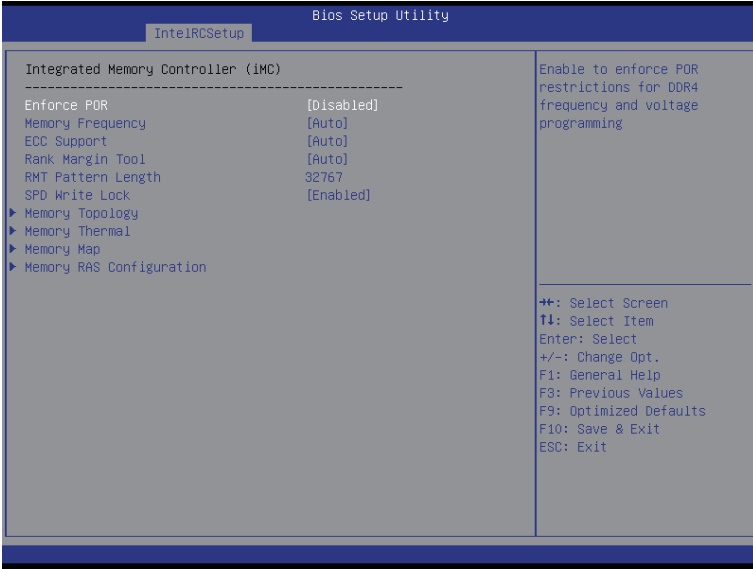

☞ Integrated Memory Controller (iMC)

☞ Enforce POR

Enable to enforce POR restrictions for DDR4 frequency and voltage programming.

Options available: Enforce POR/Disabled/Enforce Stretch Goals. Default setting is **Enforce POR**.

☞ Memory Frequency

Configure memory frequency.

Options available: Auto/1333/1400/1600/1800/1867/2000/2133.

Default setting is **Auto**.

☞ ECC Support

Options available: Auto/Disabled/Enabled. Default setting is **Auto**.

☞ Rank Margin Tool

Options available: Auto/Disabled/Enabled. Default setting is **Auto**.

☞ RMT Pattern Length

Display RMT Pattern Length.

☞ SPD Write Lock

Options available: Enabled/Disabled. Default setting is **Enabled**.

☞ Memory Topology

Press [Enter] for configuration of advanced items.

☞ Memory Thermal

Press [Enter] for configuration of advanced items.

☞ **Memory Map**

Press [Enter] for configuration of advanced items.

☞ **Memory RAS Configuration**

Press [Enter] for configuration of advanced items.

5-3-5-1 Memory Topology

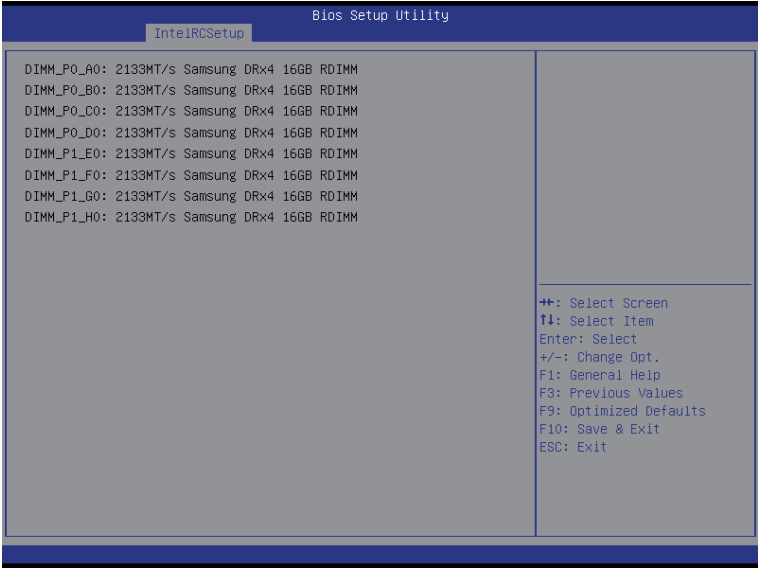

5-3-5-2 Memory Thermal

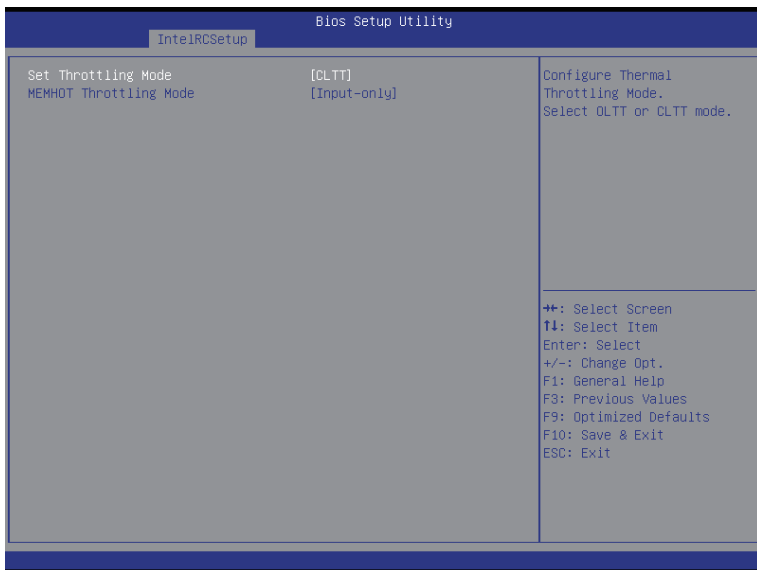

☞ Set Throttling

Configure Thermal Throttling Mode. Select OLTT or CLTT mode.

Options available: Disabled/OLTT/CLTT. Default setting is **CLTT**.

☞ MEMHOT Throttling Mode

Options available: Disabled/Output-only/Input-only. Default setting is **Input-only**.

5-3-5-3 Memory Map

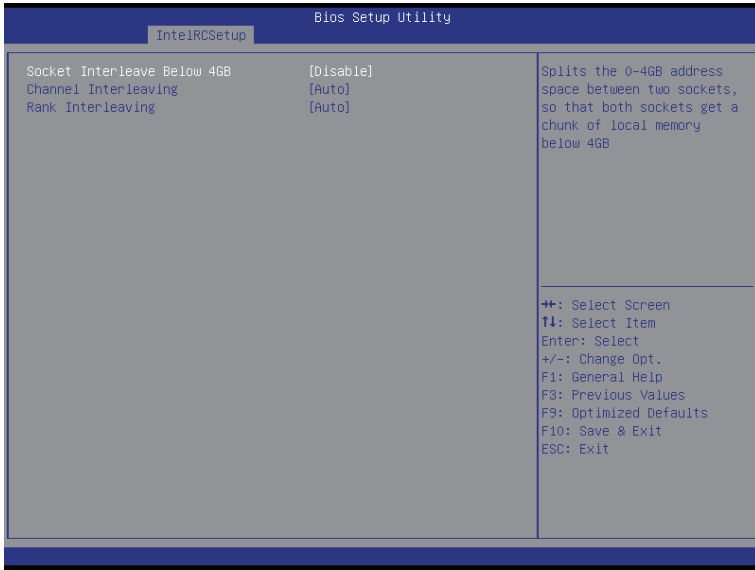

☞ **Socket Interleave Below 4GB**

Splits the 0-4GB address space between two sockets, so that both sockets get a chunk of local memory below 4GB.

Options available: Disabled/Enabled. Default setting is **Disabled**.

☞ **Channel Interleaving**

Options available: Auto/1-way Interleave/2-way Interleave/3-way Interleave/4-way Interleave.

Default setting is **Auto**.

☞ **Rank Interleaving**

Options available: Auto/1-way Interleave/2-way Interleave/4-way Interleave/8-way Interleave.

Default setting is **Auto**.

5-3-5-4 Memory RAS Configuration



☞ RAS Mode

Enable/Disable RAS modes. Enabling Sparing and Mirroring is not supported. When this item is set to enabled, Sparing will be selected.

Options available: Disable/Mirror/Lockstep Mode. Default setting is **Disabled**.

☞ Lockstep x4 DIMMs

Options available: Auto/Disabled/Enabled. Default setting is **Auto**.

☞ Memory Rank Sparing

Options available: Disabled/Enabled. Default setting is **Disabled**.

☞ Correctable Error Threshold

Press <+> / <-> keys to increase or decrease the desired values.

5-3-6 I/O Configuration

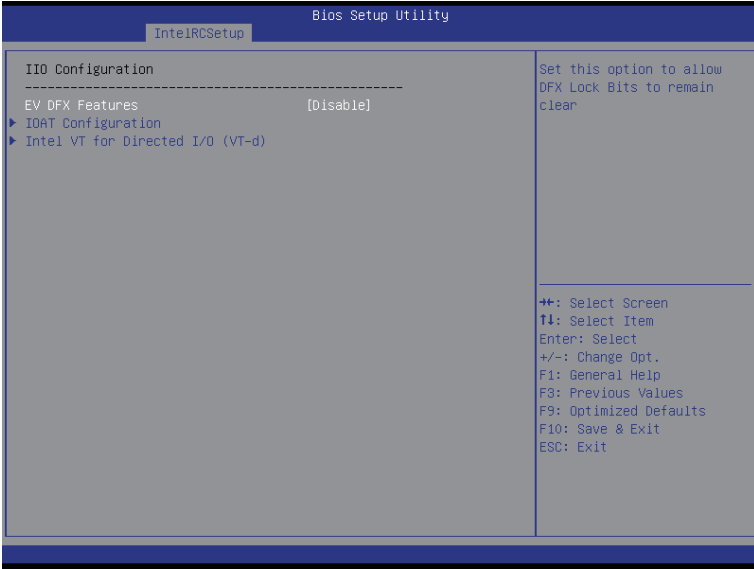

☞ I/O Configuration

☞ EV DFX Features

Set this option to allow DFX Lock Bits to remain clear.

Options available: Enabled/Disabled. Default setting is **Disabled**.

☞ IOAT Configuration

Press [Enter] for configuration of advanced items.

☞ Intel VT for Directed I/O (VT-d)

Press [Enter] for configuration of advanced items.

5-3-6-1 IOAT Configuration



☞ **IOAT Configuration**

☞ **Enable IOAT**

Control to enable/disable IOAT (Intel I/O Acceleration Technology) device.
Options available: Enabled/Disabled. Default setting is **Disabled**.

☞ **No Snoop**

Enable/Disable PCI Express Device No Snoop option.
Options available: Enabled/Disabled. Default setting is **Disabled**.

5-3-6-2 Intel VT for Directed I/O (VT-d)



- ☞ **Intel VT for Directed I/O (VT-d)**
- ☞ **VT-d Azalea VcP Optimizations**
Enable/Disable Azalea VcP optimizations.
Options available: Enabled/Disabled. Default setting is **Disabled**.
- ☞ **Intel VT for Directed I/O (VT-d)**
Enable/Disable Intel VT for Directed I/O (VT-d) support function.
Options available: Enabled/Disabled. Default setting is **Enabled**.
- ☞ **Interrupt Remapping**
Enable/Disable interrupt remapping support function.
Options available: Enabled/Disabled. Default setting is **Enabled**.
- ☞ **Coherency Suuport (Non-Isoch)**
Options available: Enabled/Disabled. Default setting is **Enabled**.
- ☞ **Coherency Suuport (Isoch)**
Options available: Enabled/Disabled. Default setting is **Enabled**.

5-3-7 PCH Configuration



☞ PCH Configuration

☞ PCH Devices

Press [Enter] for configuration of advanced items.

☞ PCH sSATA Configuration

Press [Enter] for configuration of advanced items.

☞ PCH SATA Configuration

Press [Enter] for configuration of advanced items.

☞ USB Configuration

Press [Enter] for configuration of advanced items.

5-3-7-1 PCH Devices



PCH CRID

Enable/Disable Intel Compatible Revision ID.

Options available: Enabled/Disabled. Default setting is **Disabled**.

When SATA Type is set to IDE



☞ PCH sSATA Configuration

☞ sSATA Controller(s)

Enable/Disable sSATA controller.

Options available: Enabled/Disabled. Default setting is **Enabled**.

☞ Configure sSATA as

Configure on chip SATA type.

IDE Mode: When set to IDE, the SATA controller disables its RAID and AHCI functions and runs in the IDE emulation mode. This is not allowed to access RAID setup utility.

RAID Mode: When set to RAID, the SATA controller enables both its RAID and AHCI functions. You will be allowed access to the RAID setup utility at boot time.

AHCI Mode: When set to AHCI, the SATA controller enables its AHCI functionality. Then the RAID function is disabled and cannot access the RAID setup utility at boot time.

Options available: IDE/RAID/AHCI/Disabled. Default setting is **AHCI**.

☞ SATA Test Mode

Enable/Disable SATA Test Mode.

Options available: Enabled/Disabled. Default setting is **Disabled**.

☞ SATA Mode options^(Note1)

Press [Enter] for configuration of advanced items.

☞ sSATA RSTe Boot Info^(Note2)

Enable/Disable SATA RSTe Boot Information.

Options available: Enabled/Disabled. Default setting is **Enabled**.

(Note1) Only Supported When HDD is in **AHCI** or **RAID** Mode.

(Note2) Only Supported When HDD is in **RAID** Mode.

☞ **Support Aggressive Link Power Mana^(Note)**

Enable PCH to aggressively enter link power state.

Options available: Enabled/Disabled. Default setting is **Enabled**.

☞ **Alternate Device ID on RAID**

Enable /Disable Alternate Device ID on RAID mode.

Options available: Enabled/Disabled. Default setting is **Disabled**.

Please note that this option appears when HDD is in RAID Mode.

☞ **sSATA Port 0/1/2/3**

The category identifies sSATA type of hard disk that are installed in the computer.

System will automatically detect HDD type.

☞ **Port 0/1/2/3**

Enable/Disable Port 0/1/2/3 device.

Options available: Enabled/Disabled. Default setting is **Enabled**.

☞ **Hot Plug (for Port 0/1/2/3)^(Note)**

Enable/Disable HDD Hot-Plug function.

Options available: Enabled/Disabled. Default setting is **Disabled**.

☞ **Configured as eSATA^(Note)**

Display Hot-Plug supported information.

☞ **Spin Up Device (for Port 0/1/2/3)^(Note)**

On an edge detect from 0 to 1, the PCH starts a COM reset initialization to the device.

Options available: Enabled/Disabled. Default setting is **Disabled**.

☞ **sSATA Device Type**

Select sSATA device type.

Options available: Hard Disk Drive/Solid State Drive. Default setting is **Hard Disk Drive**.

(Note) Only Supported When HDD is in **AHCI** or **RAID** Mode.

5-3-7-2-1 SATA Mode Options

When SATA Type is set to IDE/AHCI Mode



SATA LED locate

When this option is enabled, LED/SGPIO hardware is attached.

Options available: Enabled/Disabled. Default setting is **Enabled**.

When SATA Type is set to RAID Mode

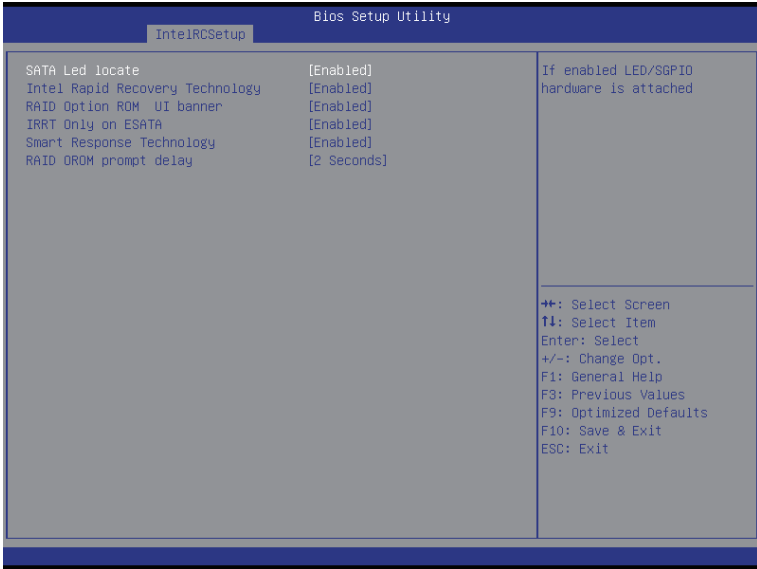

☞ SATA LED locate

When this option is enabled, LED/SGPIO hardware is attached.

Options available: Enabled/Disabled. Default setting is **Enabled**.

☞ Intel Rapid Recovery Technology

Enable/Disable Intel Rapid Recovery Technology support function.

Options available: Enabled/Disabled. Default setting is **Enabled**.

☞ RAID Option ROM UI banner

Options available: Enabled/Disabled. Default setting is **Enabled**.

☞ IRRT Only on ESATA

Options available: Enabled/Disabled. Default setting is **Enabled**.

☞ Smart Response Technology

Enable/Disable Intel Smart Response Technology support function.

Options available: Enabled/Disabled. Default setting is **Enabled**.

☞ RAID OROM prompt delay

Options available: 2 Seconds/4 Seconds/6 Seconds/8 Seconds. Default setting is **2 Seconds**.

5-3-7-3 PCH SATA Configuration

Bios Setup Utility

IntelRCSetup

PCH SATA Configuration		Enable or Disable SATA Controller
SATA Controller	[Enabled]	++: Select Screen ↑↓: Select Item Enter: Select +/-: Change Opt. F1: General Help F3: Previous Values F9: Optimized Defaults F10: Save & Exit ESC: Exit
Configure SATA as	[AHCI]	
SATA test mode	[Disabled]	
▶ SATA Mode options		
Support Aggressive Link Power Mana	[Enabled]	
SATA Port 0	[Not Installed]	
Port 0	[Enabled]	
Hot Plug	[Disabled]	
Configured as eSATA	Hot Plug supported	
Spin Up Device	[Disabled]	
SATA Device Type	[Hard Disk Drive]	
SATA Port 1	[Not Installed]	
Port 1	[Enabled]	
Hot Plug	[Disabled]	
Configured as eSATA	Hot Plug supported	
Spin Up Device	[Disabled]	
SATA Device Type	[Hard Disk Drive]	
SATA Port 2	[Not Installed]	
Port 2	[Enabled]	
Hot Plug	[Disabled]	
Configured as eSATA	Hot Plug supported	
Spin Up Device	[Disabled]	

Bios Setup Utility

IntelRCSetup

SATA Device Type	[Hard Disk Drive]	Identify the SATA port is connected to Solid State Drive or Hard Disk Drive ++: Select Screen ↑↓: Select Item Enter: Select +/-: Change Opt. F1: General Help F3: Previous Values F9: Optimized Defaults F10: Save & Exit ESC: Exit
SATA Port 2	[Not Installed]	
Port 2	[Enabled]	
Hot Plug	[Disabled]	
Configured as eSATA	Hot Plug supported	
Spin Up Device	[Disabled]	
SATA Device Type	[Hard Disk Drive]	
SATA Port 3	[Not Installed]	
Port 3	[Enabled]	
Hot Plug	[Disabled]	
Configured as eSATA	Hot Plug supported	
Spin Up Device	[Disabled]	
SATA Device Type	[Hard Disk Drive]	
SATA Port 4	[Not Installed]	
Port 4	[Enabled]	
Hot Plug	[Disabled]	
Configured as eSATA	Hot Plug supported	
Spin Up Device	[Disabled]	
SATA Device Type	[Hard Disk Drive]	
SATA Port 5	[Not Installed]	
Port 5	[Enabled]	
Hot Plug	[Disabled]	
Configured as eSATA	Hot Plug supported	
Spin Up Device	[Disabled]	
SATA Device Type	[Hard Disk Drive]	

When SATA Type is set to IDE

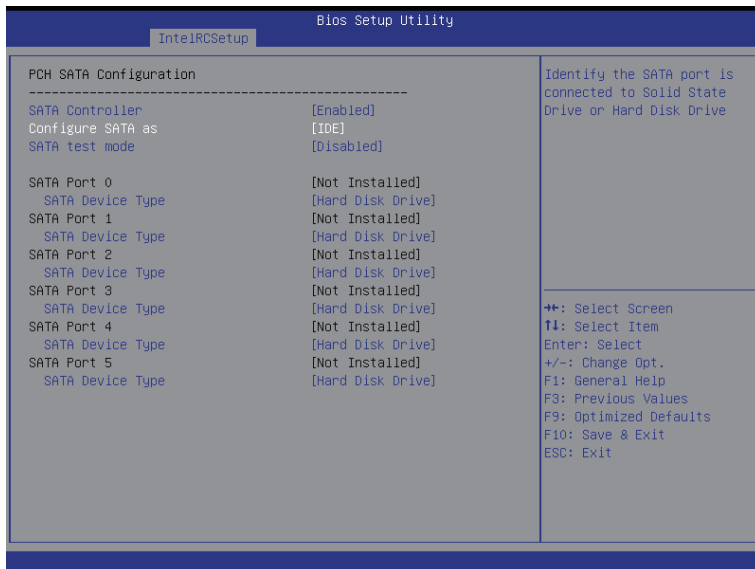

☞ PCH SATA Configuration

☞ SATA Controller(s)

Enable/Disable sSATA controller.

Options available: Enabled/Disabled. Default setting is **Enabled**.

☞ Configure sSATA as

Configure on chip SATA type.

IDE Mode: When set to IDE, the SATA controller disables its RAID and AHCI functions and runs in the IDE emulation mode. This is not allowed to access RAID setup utility.

RAID Mode: When set to RAID, the SATA controller enables both its RAID and AHCI functions. You will be allowed access to the RAID setup utility at boot time.

AHCI Mode: When set to AHCI, the SATA controller enables its AHCI functionality. Then the RAID function is disabled and cannot access the RAID setup utility at boot time.

Options available: IDE/RAID/AHCI/Disabled. Default setting is **AHCI**.

☞ SATA Test Mode

Enable/Disable SATA Test Mode.

Options available: Enabled/Disabled. Default setting is **Disabled**.

☞ SATA RSTe Boot Info^(Note 1)

Enable/Disable SATA RSTe Boot Information.

Options available: Enabled/Disabled. Default setting is **Enabled**.

☞ SATA Mode options^(Note 2)

Press [Enter] for configuration of advanced items.

(Note 1) Only Supported When HDD is in **RAID** Mode.

(Note 2) Only Supported When HDD is in **AHCI** or **RAID** Mode.

- ☞ **Support Aggressive Link Power Mana^(Note)**
Enable PCH to aggressively enter link power state.
Options available: Enabled/Disabled. Default setting is **Enabled**.
- ☞ **Alternate Device ID on RAID**
Enable /Disable Alternate Device ID on RAID mode.
Options available: Enabled/Disabled. Default setting is **Disabled**.
Please note that this option appears when HDD is in RAID Mode.
- ☞ **sSATA Port 0/1/2/3/4/5**
The category identifies sSATA type of hard disk that are installed in the computer.
System will automatically detect HDD type.
- ☞ **Port 0/1/2/3/4/5**
Enable/Disable Port 0/1/2/3 device.
Options available: Enabled/Disabled. Default setting is **Enabled**.
- ☞ **Hot Plug (for Port 0/1/2/3/4/5)^(Note)**
Enable/Disable HDD Hot-Plug function.
Options available: Enabled/Disabled. Default setting is **Disabled**.
- ☞ **Configured as eSATA^(Note)**
Display Hot-Plug supported information.
- ☞ **Spin Up Device (for Port 0/1/2/3/4/5)^(Note)**
On an edge detect from 0 to 1, the PCH starts a COM reset initialization to the device.
Options available: Enabled/Disabled. Default setting is **Disabled**.
- ☞ **sSATA Device Type**
Select sSATA device type.
Options available: Hard Disk Drive/Solid State Drive. Default setting is **Hard Disk Drive**.

(Note) Only Supported When HDD is in **AHCI** or **RAID** Mode.

5-3-7-3-1 SATA Mode Options

When SATA Type is set to IDE/AHCI Mode



🔗 SATA LED locate

When this option is enabled, LED/SGPIO hardware is attached.

Options available: Enabled/Disabled. Default setting is **Enabled**.

When SATA Type is set to RAID Mode

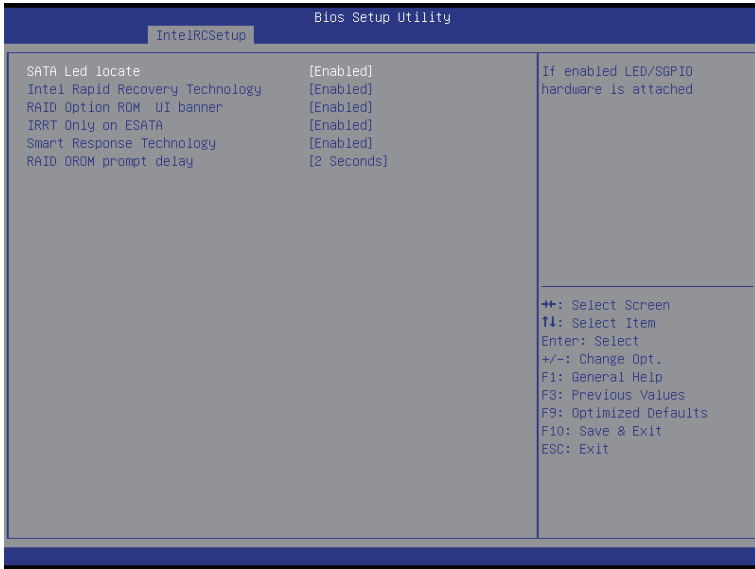

☞ SATA LED locate

When this option is enabled, LED/SGPIO hardware is attached.
Options available: Enabled/Disabled. Default setting is **Enabled**.

☞ Intel Rapid Recovery Technology

Enable/Disable Intel Rapid Recovery Technology support function.
Options available: Enabled/Disabled. Default setting is **Enabled**.

☞ RAID Option ROM UI banner

Options available: Enabled/Disabled. Default setting is **Enabled**.

☞ Smart Response Technology

Enable/Disable Intel Smart Response Technology support function.
Options available: Enabled/Disabled. Default setting is **Enabled**.

☞ RAID OROM prompt delay

Options available: 2 Seconds/4 Seconds/6 Seconds/8 Seconds. Default setting is **2 Seconds**.

5-3-7-4 USB Configuration

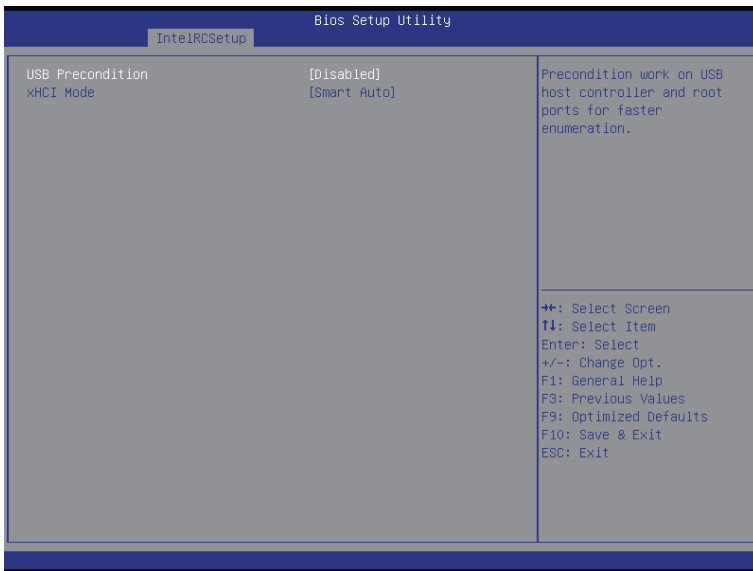

☞ USB Precondition

Precondition work on USB host controller and root ports for faster enumeration.

Options available: Enabled/Disabled. Default setting is **Disabled**.

☞ xHCI Mode

Enable/Disable xHCI (USB 3.0) support function.

Options available: Smart Auto/Enabled/Disabled. Default setting is **Smart Auto**.

5-3-8 Miscellaneous Configuration

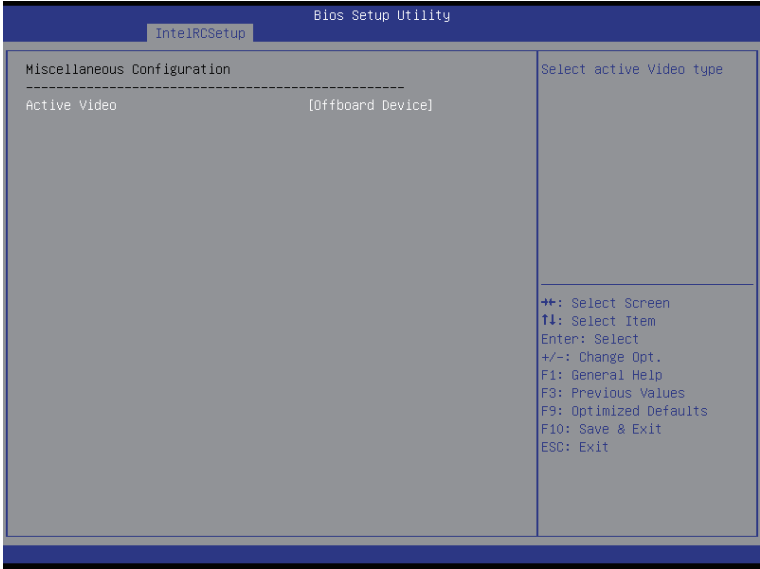

☞ Miscellaneous Configuration

☞ Active Video

Select active Video type.

Options available: Onboard Device/Offboard Device. Default setting is **Offboard Device**.

5-3-9 Server ME Configuration

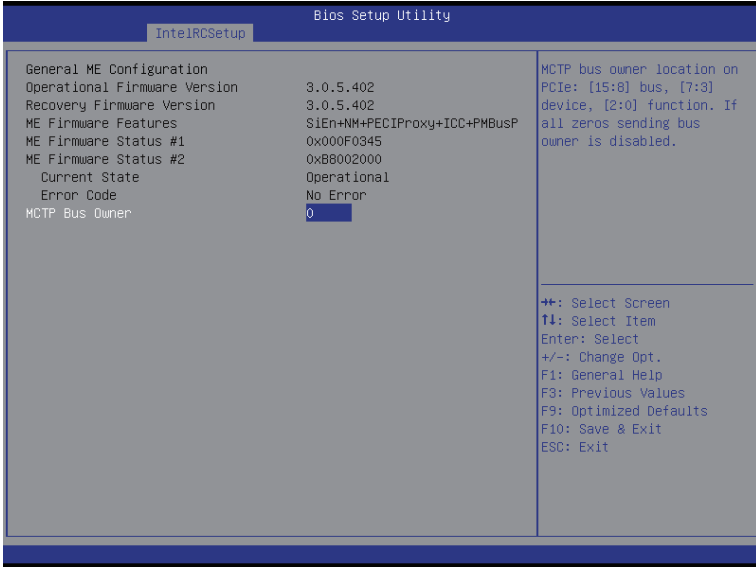

- ☞ **General ME Configuration**
- ☞ **Operational Firmware Version**
Display Operational Firmware Version information.
- ☞ **Recovery Firmware Version**
Display Recovery Firmware Version information.
- ☞ **ME Firmware Features**
Display ME Firmware features information.
- ☞ **ME Firmware Status #1/#2**
Display ME Firmware status information.
- ☞ **Current State (for ME Firmware)**
Display ME Firmware current status information.
- ☞ **Error Code (for ME Firmware)**
Display ME Firmware status error code.
- ☞ **MCTP Bus Owner**
Configure MCTP Bus Owner.

5-3-10 Runtime Error Logging

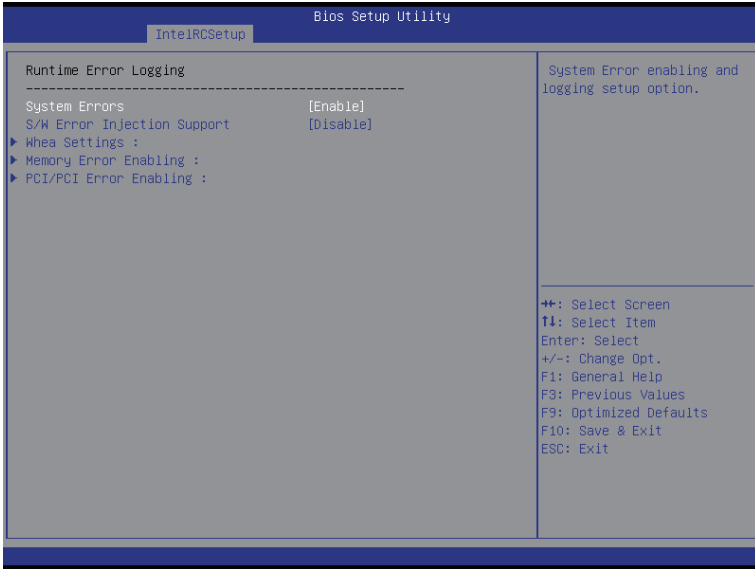

☞ Runtime Error Logging

☞ System Errors

Enable/Disable system error logging function.

Options available: Enabled/Disabled. Default setting is **Enabled**.

☞ S/W Error Injection Support

Enable/Disable software injection error logging function.

Options available: Enabled/Disabled. Default setting is **Disabled**.

☞ Whea Settings

Press [Enter] for configuration of advanced items.

☞ Memory Error Enabling

Press [Enter] for configuration of advanced items.

☞ PCI/PCI Error Enabling

Press [Enter] for configuration of advanced items.

5-3-10-1 Whea Setting



🔗 WHEA Support (Windows Hardware Error Architecture)

Enable/Disable WHEA Support.

Options available: Enabled/Disabled. Default setting is **Enabled**.

5-3-10-2 Memory Error Enabling

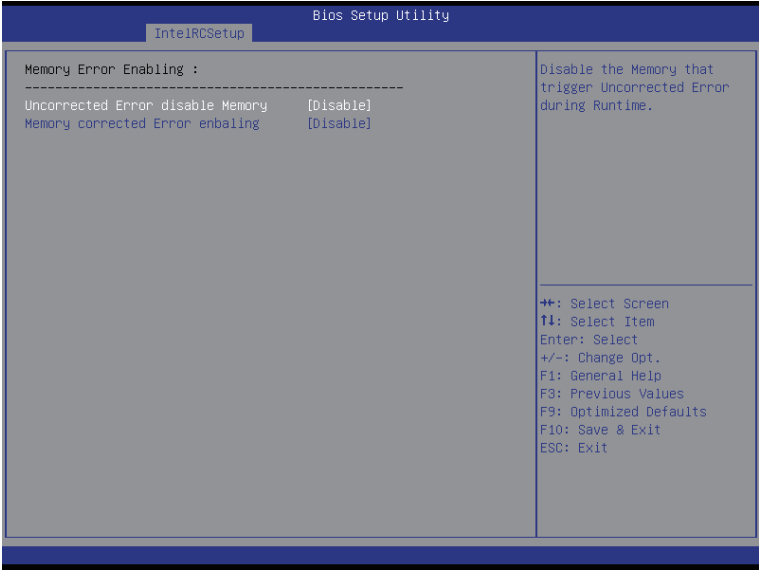

☞ **Memory Error Enabling**

☞ **Un-Correctable Errors disable Memory**

Options available: Enabled/Disabled. Default setting is **Disabled**.

☞ **Memory corrected Errors enabling**

Options available: Enabled/Disabled. Default setting is **Disabled**.

5-3-10-3 PCI/PCI Error Enabling



☞ **PCI-Ex Error Enable** ^(Note)

Options available: Yes/No. Default setting is **No**.

☞ **Corrected Error Enable**

Options available: Enabled/Disabled. Default setting is **Disabled**.

☞ **Uncorrected Error Enable**

Options available: Enabled/Disabled. Default setting is **Enabled**.

☞ **Fatal Error Enable**

Options available: Enabled/Disabled. Default setting is **Enabled**.

☞ **Enable SERR propagation**

When this item is set to enabled, PCI bus system error (SERR) is generated and is routed to NMI.

Options available: Yes/No. Default setting is **Yes**.

☞ **Enable PERR propagation**

When this item is set to Yes, PCI bus parity error (PERR) is generated and is routed to NMI.

Options available: Yes/No. Default setting is **Yes**.

(Note) Advanced items prompt when this item is set to **Yes**.

5-4 Server Management Menu

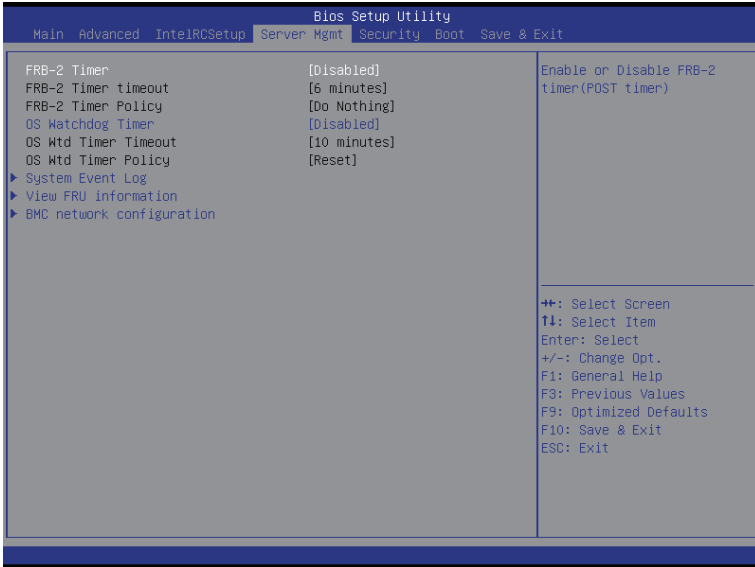

☞ FRB-2 Timer

Enable/Disable FRB-2 timer (POST timer).

Options available: Enabled/Disabled. Default setting is **Disabled**.

☞ FRB2 Timer timeout

Configure the FRB2 Timer timeout.

Options available: 3 minutes/4 minutes/5 minutes/6 minutes. Default setting is **6 minutes**.

Please note that this item is configurable when FRB-2 Timer is set to Enabled.

☞ FRB2 Timer Policy

Configure the FRB2 Timer policy.

Options available: Do Nothing/Reset/Power Down. Default setting is **Do Nothing**.

Please note that this item is configurable when FRB-2 Timer is set to Enabled.

☞ OS Watchdog Timer

Enable/Disable OS Watchdog Timer function.

Options available: Enabled/Disabled. Default setting is **Disabled**.

☞ OS Wtd Timer Timeout

Configure OS Watchdog Timer.

Options available: 5 minutes/10 minutes/15 minutes/20 minutes. Default setting is **10 minutes**.

Please note that this item is configurable when OS Watchdog Timer is set to Enabled.

☞ OS Wtd Timer Policy

Configure OS Watchdog Timer Policy.

Options available: Reset/Do Nothing/Power Down. Default setting is **Reset**.

Please note that this item is configurable when OS Watchdog Timer is set to Enabled.

☞ **System Event Log**

Press [Enter] for configuration of advanced items.

☞ **View FRU Information**

Press [Enter] to view the advanced items.

☞ **BMC network configuration**

Press [Enter] for configuration of advanced items.

5-4-1 System Event Log

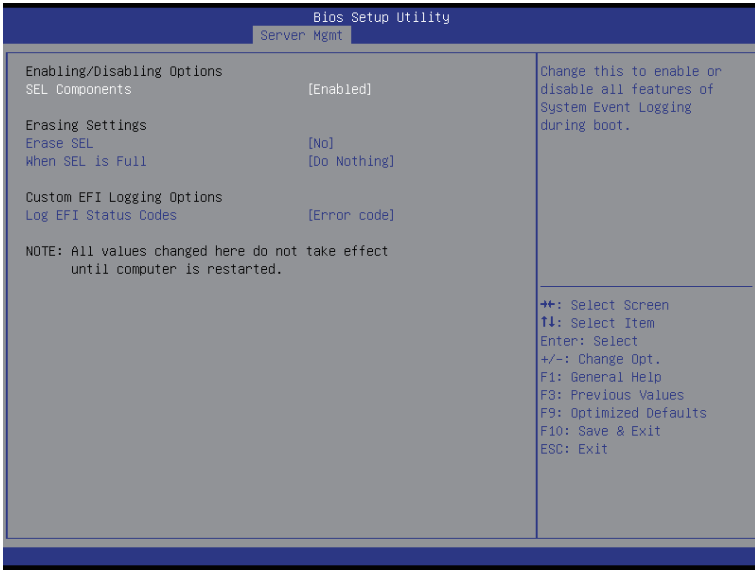

☞ Enabling/Disabling Options

☞ SEL Components

Change this to enable or disable all features of System Event Logging during boot.
Options available: Enabled/Disabled. Default setting is **Enabled**.

☞ Erasing Settings

☞ Erasing SEL

Choose options for erasing SEL.

Options available: No/Yes, On next reset/Yes, On every reset. Default setting is **No**.

☞ When SEL is Full

Choose options for reactions to a full SEL.

Options available: Do Nothing/Erase Immediately. Default setting is **Do Nothing**.

☞ Custom EFI Logging Options

☞ Log EFI Status Codes

Enable/Disable the logging of EFI Status Codes (if not already converted to legacy).

Options available: Disabled/Both/Error code/Progress code. Default setting is **Error code**.

5-4-2 View FRU Information

The FRU page is a simple display page for basic system ID information, as well as System product information. Items on this window are non-configurable.

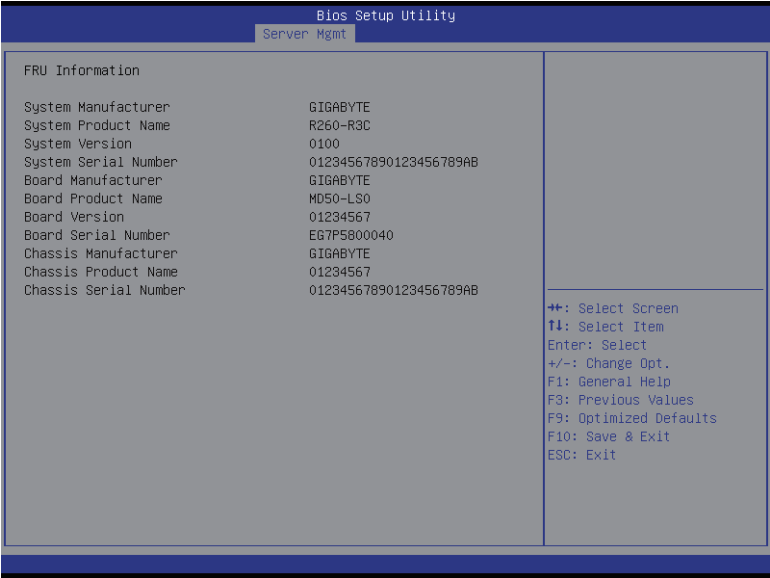

5-4-3 BMC network configuration

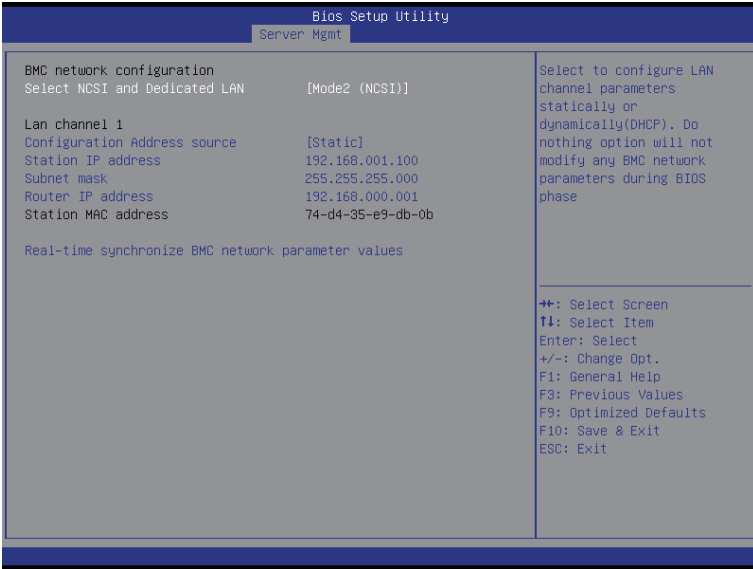

☞ BMC network configuration

☞ Select NCSI and Dedicated LAN

Switch NCSI and dedicated LAN and send KCS command.

Options available: Mode2(NCSI)/ Mode1 (Dedicated)/Do Nothing. Default setting is **Do Nothing**.

☞ Lan Channel 1

☞ Configuration Address source

Select to configure LAN channel parameters statically or dynamically (DHCP). Do nothing option will not modify any BMC network parameters during BIOS phase.

Options available: Unspecified/Static/DynamicBmcDhcp. Default setting is **Unspecified/Static**.

☞ Station IP Address

Display IP Address information.

☞ Subnet mask

Display Subnet Mask information.

Please note that the IP address must be in three digitals, for example, 192.168.000.001.

☞ Router IP address

Display the Router IP Address information.

☞ Station MAC Address

Display the MAC Address information.

☞ Real-time synchronize BMC network parameter values

Press [Enter] to synchronize BMC network parameter values.

5-5 Security Menu

The Security menu allows you to safeguard and protect the system from unauthorized use by setting up access passwords.

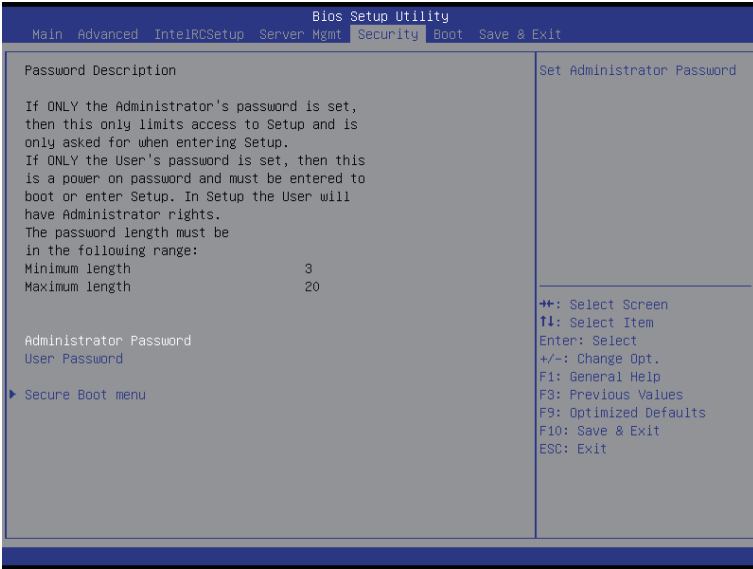

There are two types of passwords that you can set:

- **Administrator Password**
Entering this password will allow the user to access and change all settings in the Setup Utility.
- **User Password**
Entering this password will restrict a user's access to the Setup menus. To enable or disable this field, a Administrator Password must first be set. A user can only access and modify the System Time, System Date, and Set User Password fields.

🔑 Administrator Password

Press Enter to configure the Administrator password.

🔑 User Password

Press Enter to configure the user password.

🔑 Secure Boot menu

Press [Enter] for configuration of advanced items.

5-5-1 Secure Boot menu

The Secure Boot Menu is applicable when your device is installed the Windows® 8 operatin system.

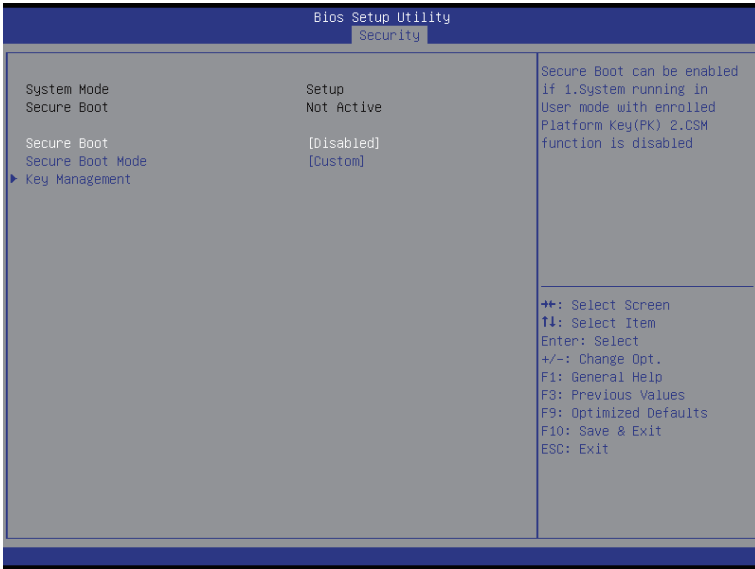

☞ **Secure Mode**

Display the System secure mode state.

☞ **Secure Boot**

Display the status of Secure Boot.

☞ **Secure Boot**

Enable/Disable Secure Boot function.

Options available: Enabled/Disabled. Default setting is **Disabled**.

☞ **Secure Boot Mode**

Secure Boot requires all the applications that are running during the booting process to be pre-signed with valid digital certificates. This way, the system knows all the files being loaded before Windows 8 loads and gets to the login screen have not been tampered with.

When set to Standard, it will automatically load the Secure Boot keys from the BIOS databases.

When set to Custom, you can customize the Secure Boot settings and manually load its keys from the BIOS database.

Options available: Standard/Custom. Default setting is **Standard**.

☞ **Key Management^(Note)**

Press [Enter] for configuration of advanced items.

(Note) Advanced items prompt when this item is set to **Custom**.

5-5-1-1 Key Management

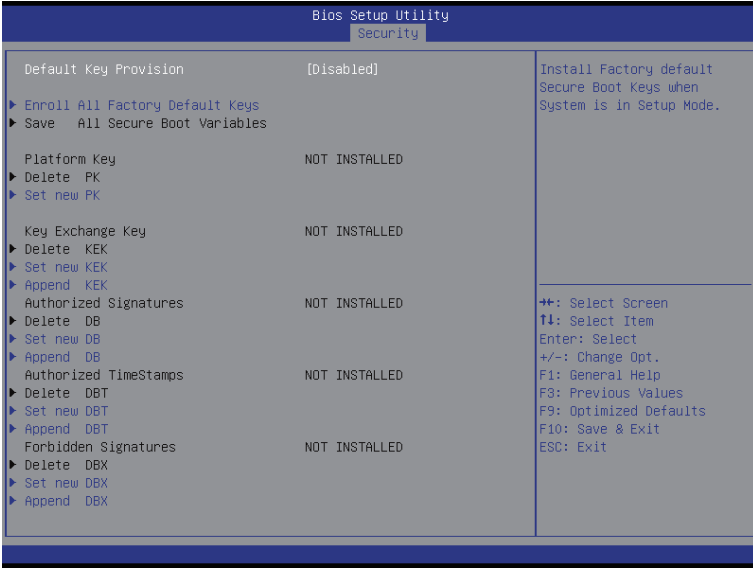

☞ Default Key Provisioning

Force the system to Setup Mode. This will clear all Secure Boot Variables such as Platform Key (PK), Key-exchange Key (KEK), Authorized Signature Database (db), and Forbidden Signatures Database (dbx).

Options available: Enabled/Disabled. Default setting is **Disabled**.

☞ Enroll All Factory Default Keys

Press [Enter] to install all factory default keys.

☞ Save All Secure Boot Variables

Press [Enter] to save all Secure Boot Variables.

☞ Platform Key (PK)

Display the status of Platform Key.

☞ Delete the PK

Press [Enter] to delete the existed PK. Once the PK is deleted, all the system's Secure Boot keys will not be activated.

☞ Set new PK File

Press [Enter] to configure a new PK.

☞ Key Exchange Key Database (KEK)

Display the status of Platform Key.

☞ Delete KEK

Press [Enter] to delete the KEK from your system.

☞ Set new KEK

Press [Enter] to configure a new KEK.

☞ **Append Var to KEK**

Press [Enter] to load additional KEK from a storage devices for an additional db and dbx management.

☞ **Authorized Signature Database (DB)**

Display the status of Authorized Signature Database.

☞ **Delete DB**

Press [Enter] to delete the db from your system.

☞ **Set new DB**

Press [Enter] to configure a new db.

☞ **Append aVar to DB**

Press [Enter] to load additional db from a storage devices.

☞ **Forbidden Signature Database (DBX)**

Display the status of Forbidden Signature Database.

☞ **Delete the DBX**

Press [Enter] to delete the dbx from your system.

☞ **Set DBX from File**

Press [Enter] to configure a new dbx.

☞ **Append Var to DBX**

Press [Enter] to load additional db from a storage devices.

5-6 Boot Menu

The Boot menu allows you to set the drive priority during system boot-up. BIOS setup will display an error message if the legacy drive(s) specified is not bootable.

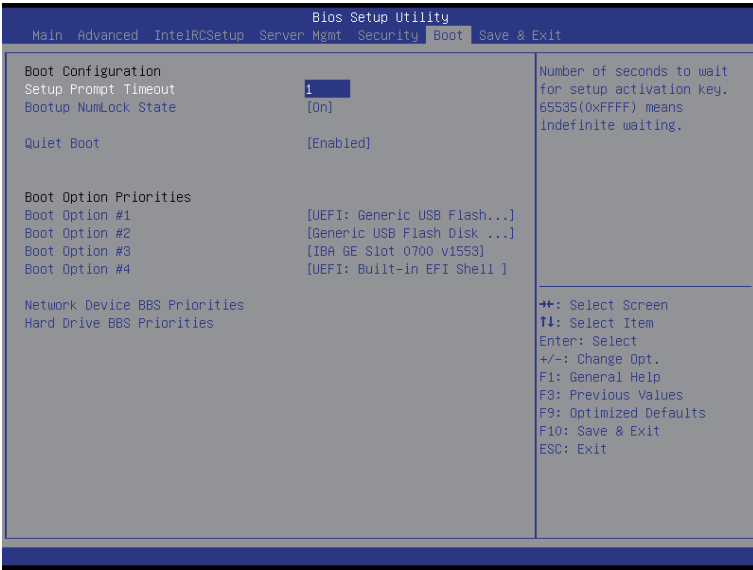

⌄ Boot Configuration

⌄ Setup Prompt Timeout

Number of seconds to wait for setup activation key. 65535(0xFFFF) means indefinite waiting." Press the numeric keys to input the desired value.

⌄ Bootup NumLock State

Enable or Disable Bootup NumLock function.
Options available: On/Off. Default setting is **On**.

⌄ Quiet Boot

Enables or disables showing the logo during POST.
Options available: Enabled/Disabled. Default setting is **Enabled**.

⌄ Boot Option Priorities

⌄ Boot Option #1/#2/#3#4

Press Enter to configure the boot priority.
By default, the server searches for boot devices in the following sequence:

1. UEFI device.
2. Hard drive.
3. Network device.
4. USB device

☞ **Network Device BBS Priorities**

Press Enter to configure the boot priority.

☞ **Hard Drive BBS Priorities**

Press Enter to configure the boot priority.

5-7 Save & Exit Menu

The Exit menu displays the various options to quit from the BIOS setup. Highlight any of the exit options then press **Enter**.

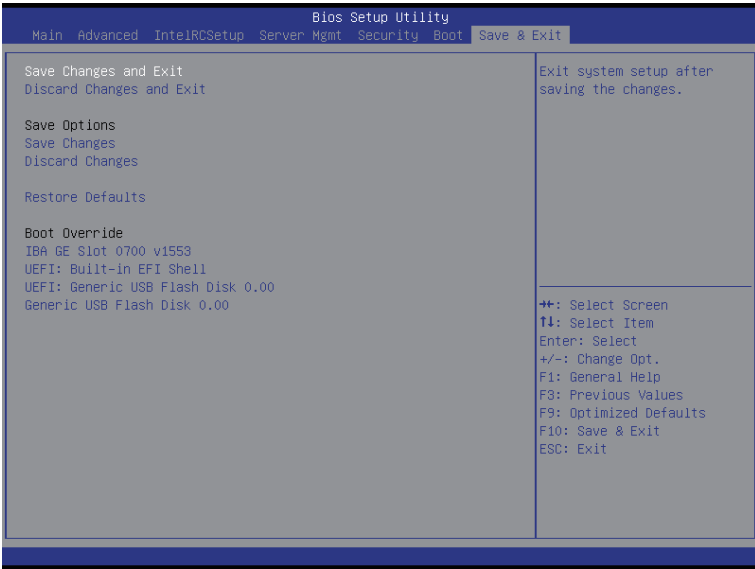

☞ Save Changes and Exit

Saves changes made and close the BIOS setup.

Options available: Yes/No.

☞ Discard Changes and Exit

Discards changes made and exit the BIOS setup.

Options available: Yes/No.

☞ Save Options

☞ Save Changes

Saves changes made in the BIOS setup.

Options available: Yes/No.

☞ Discard Changes

Discards changes made and close the BIOS setup.

Options available: Yes/No.

☞ Restore Defaults

Loads the default settings for all BIOS setup parameters. Setup Defaults are quite demanding in terms of resources consumption. If you are using low-speed memory chips or other kinds of low-performance components and you choose to load these settings, the system might not function properly.

Options available: Yes/No.

☞ **Boot Override**

Press Enter to configure the device as the boot-up drive.

☞ **UEFI: Built-in in EFI Shell**

Press <Enter> on this item to Launch EFI Shell from filesystem device.

5-8 BIOS POST Codes

PEI_CORE_STARTED	0x10
PEI_CAR_CPU_INIT	0x11
// reserved for CPU 0x12 - 0x14	
PEI_CAR_NB_INIT	0x15
// reserved for NB 0x16 - 0x18	
PEI_CAR_SB_INIT	0x19
// reserved for SB 0x1A - 0x1C	
PEI_MEMORY_SPD_READ	0x1D
PEI_MEMORY_PRESENCE_DETECT	0x1E
PEI_MEMORY_TIMING	0x1F
PEI_MEMORY_CONFIGURING	0x20
PEI_MEMORY_INIT	0x21
// reserved for OEM use: 0x22 - 0x2F	
// reserved for AML use: 0x30	
PEI_MEMORY_INSTALLED	0x31
PEI_CPU_INIT	0x32
PEI_CPU_CACHE_INIT	0x33
PEI_CPU_BSP_SELECT	0x34
PEI_CPU_AP_INIT	0x35
PEI_CPU_SMM_INIT	0x36
PEI_MEM_NB_INIT	0x37
// reserved for NB 0x38 - 0x3A	
PEI_MEM_SB_INIT	0x3B
// reserved for SB 0x3C - 0x3E	
// reserved for OEM use: 0x3F - 0x4E	
PEI_DXE_IPL_STARTED	0x4F
//Recovery	
PEI_RECOVERY_AUTO	0xF0
PEI_RECOVERY_USER	0xF1
PEI_RECOVERY_STARTED	0xF2
PEI_RECOVERY_CAPSULE_FOUND	0xF3
PEI_RECOVERY_CAPSULE_LOADED	0xF4
//S3	
PEI_S3_STARTED	0xE0
PEI_S3_BOOT_SCRIPT	0xE1
PEI_S3_VIDEO_REPOST	0xE2
PEI_S3_OS_WAKE	0xE3
//DXE_STATUS_CODE	
DXE_CORE_STARTED	0x60
DXE_NVRAM_INIT	0x61
DXE_SBRUN_INIT	0x62

DXE_CPU_INIT	0x63
//reserved for CPU 0x64 - 0x67	
DXE_NB_HB_INIT	0x68
DXE_NB_INIT	0x69
DXE_NB_SMM_INIT	0x6A
//reserved for NB 0x6B - 0x6F	
DXE_SB_INIT	0x70
DXE_SB_SMM_INIT	0x71
DXE_SB_DEVICES_INIT	0x72
//reserved for SB 0x73 - 0x77	
DXE_ACPI_INIT	0x78
DXE_CSM_INIT	0x79
//reserved for AMI use: 0x7A - 0x7F	
//reserved for OEM use: 0x80 - 0x8F	
DXE_BDS_STARTED	0x90
DXE_BDS_CONNECT_DRIVERS	0x91
DXE_PCI_BUS_BEGIN	0x92
DXE_PCI_BUS_HPC_INIT	0x93
DXE_PCI_BUS_ENUM	0x94
DXE_PCI_BUS_REQUEST_RESOURCES	0x95
DXE_PCI_BUS_ASSIGN_RESOURCES	0x96
DXE_CON_OUT_CONNECT	0x97
DXE_CON_IN_CONNECT	0x98
DXE_SIO_INIT	0x99
DXE_USB_BEGIN	0x9A
DXE_USB_RESET	0x9B
DXE_USB_DETECT	0x9C
DXE_USB_ENABLE	0x9D
//reserved for AMI use: 0x9E - 0x9F	
//reserved for AML use: 0xA0	
DXE_IDE_BEGIN	0xA1
DXE_IDE_RESET	0xA2
DXE_IDE_DETECT	0xA3
DXE_IDE_ENABLE	0xA4
DXE_SCSI_BEGIN	0xA5
DXE_SCSI_RESET	0xA6
DXE_SCSI_DETECT	0xA7
DXE_SCSI_ENABLE	0xA8
DXE_SETUP_VERIFYING_PASSWORD	0xA9
//reserved for AML use: 0xAA	
DXE_SETUP_START	0xAB
DXE_SETUP_INPUT_WAIT	0xAC

DXE_READY_TO_BOOT	0xAD
DXE_LEGACY_BOOT	0xAE
DXE_EXIT_BOOT_SERVICES	0xAF
RT_SET_VIRTUAL_ADDRESS_MAP_BEGIN	0xB0
RT_SET_VIRTUAL_ADDRESS_MAP_END	0xB1
DXE_LEGACY_OPROM_INIT	0xB2
DXE_RESET_SYSTEM	0xB3
DXE_USB_HOTPLUG	0xB4
DXE_PCI_BUS_HOTPLUG	0xB5
DXE_NVRAM_CLEANUP	0xB6
DXE_CONFIGURATION_RESET	0xB7
//reserved for AMI use: 0xB8 - 0xBF	
//reserved for OEM use: 0xC0 - 0xCF	
//PEI_STATUS_CODE	
//Errors	
//Regular boot	
PEI_MEMORY_INVALID_TYPE	0x50
PEI_MEMORY_INVALID_SPEED	0x50
PEI_MEMORY_SPD_FAIL	0x51
PEI_MEMORY_INVALID_SIZE	0x52
PEI_MEMORY_MISMATCH	0x52
PEI_MEMORY_NOT_DETECTED	0x53
PEI_MEMORY_NONE_USEFUL	0x53
PEI_MEMORY_ERROR	0x54
PEI_MEMORY_NOT_INSTALLED	0x55
PEI_CPU_INVALID_TYPE	0x56
PEI_CPU_INVALID_SPEED	0x56
PEI_CPU_MISMATCH	0x57
PEI_CPU_SELF_TEST_FAILED	0x58
PEI_CPU_CACHE_ERROR	0x58
PEI_CPU_MICROCODE_UPDATE_FAILED	0x59
PEI_CPU_NO_MICROCODE	0x59
PEI_CPU_INTERNAL_ERROR	0x5A
PEI_CPU_ERROR	0x5A
PEI_RESET_NOT_AVAILABLE	x5B
//reserved for AMI use: 0x5C - 0x5F	
//Recovery	
PEI_RECOVERY_PPI_NOT_FOUND	0xF8
PEI_RECOVERY_NO_CAPSULE	0xF9
PEI_RECOVERY_INVALID_CAPSULE	0xFA
//reserved for AMI use: 0xFB - 0xFF	
//S3 Resume	

PEI_MEMORY_S3_RESUME_FAILED	0xE8
PEI_S3_RESUME_PPI_NOT_FOUND	0xE9
PEI_S3_BOOT_SCRIPT_ERROR	0xEA
PEI_S3_OS_WAKE_ERROR	0xEB
//reserved for AMI use: 0xEC - 0xEF	
// DXE_STATUS_CODE	
DXE_CPU_ERROR	0xD0
DXE_NB_ERROR	0xD1
DXE_SB_ERROR	0xD2
DXE_ARCH_PROTOCOL_NOT_AVAILABLE	0xD3
DXE_PCI_BUS_OUT_OF_RESOURCES	0xD4
DXE_LEGACY_OPROM_NO_SPACE	0xD5
DXE_NO_CON_OUT	0xD6
DXE_NO_CON_IN	0xD7
DXE_INVALID_PASSWORD	0xD8
DXE_BOOT_OPTION_LOAD_ERROR	0xD9
DXE_BOOT_OPTION_FAILED	0xDA
DXE_FLASH_UPDATE_FAILED	0xDB
DXE_RESET_NOT_AVAILABLE	0xDC
//reserved for AMI use: 0xDE - 0xDF	

5-9 BIOS POST Beep code

5-9-1 PEI Beep Codes

# of Beeps	Description
1	Memory not Installed.
1	Memory was installed twice (InstallPeiMemory routine in PEI Core called twice)
2	Recovery started
3	DXEIPL was not found
3	DXE Core Firmware Volume was not found
4	Recovery failed
4	S3 Resume failed
7	Reset PPI is not available

5-9-2 DEX Beep Codes

# of Beeps	Description
1	Invalid password
4	Some of the Architectural Protocols are not available
5	No Console Output Devices are found
5	No Console Input Devices are found
6	Flash update is failed
7	Reset protocol is not available

5-10 BIOS Recovery Instruction

The system has an embedded recovery technique. In the event that the BIOS becomes corrupt the boot block can be used to restore the BIOS to a working state. To restore your BIOS, please follow the instructions listed below:

Recovery Instruction:

1. Change xxx.ROM to amiboot.rom.
2. Copy amiboot.rom and AFUDOS.exe to USB diskette.
3. Setting BIOS Recovery jump to enabled status.

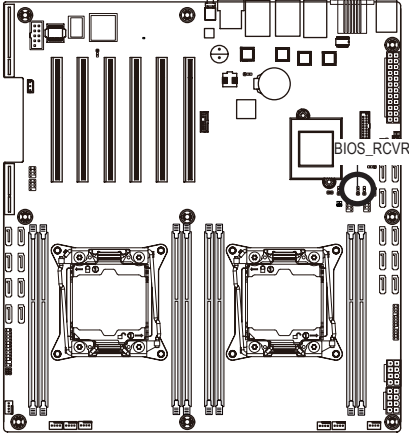

4. Boot into BIOS recovery.
5. Run Proceed with flash update.
6. BIOS update.

