

GIGABYTE™

MZ33-AR1

Motherboard - AMD EPYC™ 9005/9004 - E-ATX UP

User Manual

Rev. 3.0

Copyright

© 2024 GIGA-BYTE TECHNOLOGY CO., LTD. All rights reserved.

The trademarks mentioned in this manual are legally registered to their respective owners.

Disclaimer

Information in this manual is protected by copyright laws and is the property of GIGABYTE.

Changes to the specifications and features in this manual may be made by GIGABYTE without prior notice. No part of this manual may be reproduced, copied, translated, transmitted, or published in any form or by any means without GIGABYTE's prior written permission.

Documentation Classifications

In order to assist in the use of this product, GIGABYTE provides the following types of documentation:

- User Manual: detailed information & steps about the installation, configuration and use this product (e.g. motherboard, server barebones), covering hardware and BIOS.
- User Guide: detailed information about the installation & use of an add-on hardware or software component (e.g. BMC firmware, rail-kit) compatible with this product.
- Quick Installation Guide: a short guide with visual diagrams that you can reference easily for installation purposes of this product (e.g. motherboard, server barebones).

Please see the support section of the online product page to check the current availability of these documents

For More Information

For related product specifications, the latest firmware and software, and other information, please visit our website at: <http://www.gigabyte.com>.

For GIGABYTE distributors and resellers, additional sales & marketing materials are available from our reseller portal: <http://reseller.b2b.gigabyte.com>

For further technical assistance, please contact your GIGABYTE representative or visit <http://esupport.gigabyte.com/> to create a new support ticket.

For any general sales or marketing enquires, you may message GIGABYTE server directly by email: server.grp@gigabyte.com.

Table of Contents

MZ33-AR1 Motherboard Layout	5
Block Diagram	7
Chapter 1 Hardware Installation	8
1-1 Installation Precautions	8
1-2 Product Specifications	9
1-3 Installing and Removing the CPU and Heat Sink	12
1-4 Installing and Removing Memory	13
1-4-1 12-Channel Memory Configuration	13
1-4-2 Installing and Removing the Memory Module	14
1-4-3 Processor and Memory Module Matrix Table	14
1-4-4 Memory Population Table	15
1-5 Installing and Removing the M.2 SSD Module	17
1-6 Back Panel Connectors	18
1-7 Internal Connectors	19
1-8 Jumper Settings	27
Chapter 2 BIOS Setup	28
2-1 The Main Menu	30
2-2 Advanced Menu	33
2-2-1 Trusted Computing	35
2-2-2 PSP Firmware Versions	36
2-2-3 Legacy Video Select	37
2-2-4 AST2600 Super IO Configuration	38
2-2-5 S5 RTC Wake Settings	40
2-2-6 Serial Port Console Redirection	41
2-2-7 CPU Configuration	45
2-2-8 PCI Subsystem Settings	46
2-2-9 USB Configuration	48
2-2-10 Network Stack Configuration	50
2-2-11 Post Report Configuration	51
2-2-12 NVMe Configuration	52
2-2-13 SATA Configuration	53
2-2-14 Graphic Output Configuration	54
2-2-15 AMD Mem Configuration Status	55
2-2-16 Tls Auth Configuration	56
2-2-17 RAM Disk Configuration	57
2-2-18 iSCSI Configuration	58

2-2-19	Broadcom BCM57416 10GBASE-T Network Connection	59
2-2-20	VLAN Configuration	65
2-2-21	MAC IPv4 Network Configuration	66
2-2-22	MAC IPv6 Network Configuration	67
2-3	AMD CBS Menu	68
2-3-1	CPU Common Options	69
2-3-2	DF Common Options	75
2-3-3	UMC Common Options	82
2-3-4	NBIO Common Options	103
2-3-5	FCH Common Options	113
2-3-6	SOC Miscellaneous Control	122
2-3-7	CXL Common Options	124
2-4	AMD PBS Menu	125
2-4-1	RAS	126
2-5	Chipset Setup Menu	128
2-5-1	North Bridge	129
2-5-2	Fabric Resource	130
2-6	Server Management Menu	132
2-6-1	System Event Log	134
2-6-2	View FRU Information	135
2-6-3	BMC Network Configuration	136
2-6-4	IPv6 BMC Network Configuration	137
2-7	Security Menu	138
2-7-1	Secure Boot	139
2-8	Boot Menu	141
2-9	Save & Exit Menu	143
2-10	BIOS Recovery	144
2-11	BIOS POST Beep code (AMI standard)	145
2-11-1	PEI Beep Codes	145
2-11-2	DXE Beep Codes	145

MZ33-AR1 Motherboard Layout

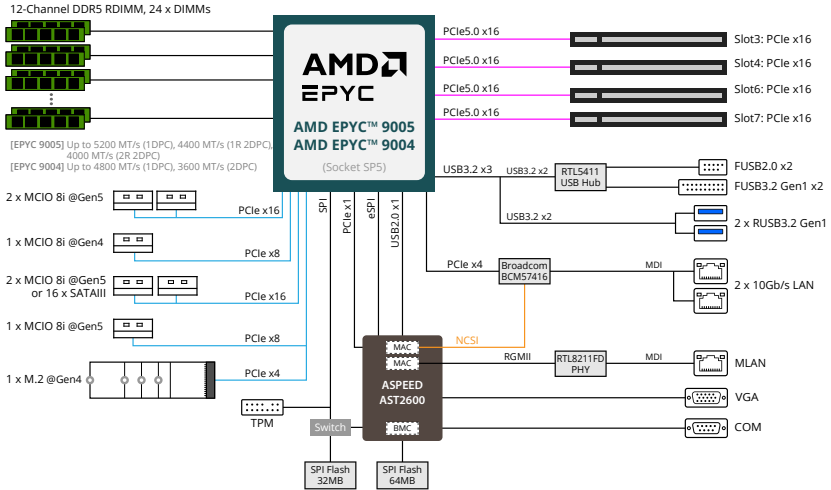

Item	Code	Description
1	SW_ID	ID Button with LED
2	USB3_MLAN	Sever Management LAN Port (Top)/USB 3.2 Gen1 Ports (Bottom)
3	LAN1	10GbE LAN Port #1
4	LAN2	10GbE LAN Port #2
5	COM1_VGA	Serial Port (Top)/VGA Port (Bottom)
6	SYS_FAN4	System Fan Connector #4
7	SYS_FAN5	System Fan Connector #5
8	P12V_PCIE	2x3 Pin 12V Power Connector
9	ATX1	2x12 Pin Main Power Connector
10	PMBUS	PMBus Connector
11	CPU0_FAN1	CPU Fan Connector #1
12	M2_0	M.2 Slot (PCIe Gen4 x4, Support NGFF-2280/22110)
13	P12V_AUX2	2x4 Pin 12V Power Connector
14	P12V_AUX1	2x4 Pin 12V Power Connector
15	U2_P0_G2A	MCIO Connector (PCIe Gen5)
16	U2_P0_G3A	MCIO Connector (PCIe Gen5/SATA)
17	U2_P0_G3B	MCIO Connector (PCIe Gen5/SATA)
18	U2_P0_G0A	MCIO Connector (PCIe Gen5)
19	U2_P0_G0B	MCIO Connector (PCIe Gen5)
20	U2_P0_G1B	MCIO Connector (PCIe Gen4)
21	F_USB3	Front Panel USB 3.2 Gen1 Connector
22	FP_1	Front Panel Header
23	CASE_OPEN	Case Open Intrusion Alert Header
24	F_USB2	Front Panel USB 2.0 Header
25	BP_1	HDD Backplane Board Connector
26	SYS_FAN1	System Fan Connector #1
27	SYS_FAN2	System Fan Connector #2
28	SYS_FAN3	System Fan Connector #3
29	CN_NCSI	NCSI Connector
30	IPMB	IPMB Connector
31	PCIE_3	PCIe x16 Slot #3 (Gen5 x16)
32	PCIE_4	PCIe x16 Slot #4 (Gen5 x16)
33	PCIE_6	PCIe x16 Slot #6 (Gen5 x16)
34	PCIE_7	PCIe x16 Slot #7 (Gen5 x16)
35	SPI_TPM	TPM Connector
36	BAT	Battery Socket
37	LED_BMC	BMC Firmware Readiness LED

Chapter 1 Hardware Installation

1-1 Installation Precautions

The motherboard contains numerous delicate electronic circuits and components which can become damaged as a result of electrostatic discharge (ESD). Prior to installation, carefully read the user's manual and follow these procedures:

- Prior to installation, do not remove or break motherboard S/N (Serial Number) sticker or warranty sticker provided by your dealer. These stickers are required for warranty validation.
- Always remove the AC power by unplugging the power cord from the power outlet before installing or removing the motherboard or other hardware components.
- When connecting hardware components to the internal connectors on the motherboard, make sure they are connected tightly and securely.
- When handling the motherboard, avoid touching any metal leads or connectors.
- It is best to wear an electrostatic discharge (ESD) wrist strap when handling electronic components such as a motherboard, CPU or memory. If you do not have an ESD wrist strap, keep your hands dry and first touch a metal object to eliminate static electricity.
- Prior to installing the motherboard, please have it on top of an antistatic pad or within an electrostatic shielding container.
- Before unplugging the power supply cable from the motherboard, make sure the power supply has been turned off.
- Before turning on the power, make sure the power supply voltage has been set according to the local voltage standard.
- Before using the product, please verify that all cables and power connectors of your hardware components are connected.
- To prevent damage to the motherboard, do not allow screws to come in contact with the motherboard circuit or its components.
- Make sure there are no leftover screws or metal components placed on the motherboard or within the computer casing.
- Do not place the computer system on an uneven surface.
- Do not place the computer system in a high-temperature environment.
- Turning on the computer power during the installation process can lead to damage to system components as well as physical harm to the user.
- If you are uncertain about any installation steps or have a problem related to the use of the product, please consult a certified computer technician.





1-2 Product Specifications



NOTE:

We reserve the right to make any changes to the product specifications and product-related information without prior notice.

	Form Factor	<ul style="list-style-type: none"> ◆ E-ATX ◆ 304.8 x 330.2 (mm)
	CPU	<ul style="list-style-type: none"> ◆ AMD EPYC™ 9005 Series Processors ◆ AMD EPYC™ 9004 Series Processors ◆ Single processor, cTDP up to 500W
	Socket	<ul style="list-style-type: none"> ◆ 1 x LGA 6096 ◆ Socket SP5
	Chipset	<ul style="list-style-type: none"> ◆ System on Chip
	Memory Type	<ul style="list-style-type: none"> ◆ 24 x DIMM slots ◆ DDR5 memory supported ◆ 12-Channel memory architecture
		<p>AMD EPYC™ 9005:</p> <ul style="list-style-type: none"> ◆ RDIMM: Up to 5200 MT/s (1DPC) ◆ RDIMM: Up to 4400 MT/s (1R 2DPC), 4000 MT/s (2R 2DPC) <p>AMD EPYC™ 9004:</p> <ul style="list-style-type: none"> ◆ RDIMM: Up to 4800 MT/s (1DPC), 3600 MT/s (2DPC)
	Integrated Network	<ul style="list-style-type: none"> ◆ 2 x 10Gb/s LAN (1 x Broadcom® BCM57416) ◆ - Support NCSI function
		<ul style="list-style-type: none"> ◆ 1 x 10/100/1000 Mbps Management LAN
	Integrated Video Controller	<ul style="list-style-type: none"> ◆ Integrated in Aspeed® AST2600 ◆ - 1 x VGA port
	Storage Interface	<p>MCIO:</p> <ul style="list-style-type: none"> ◆ 2 x MCIO 8i for 4 x Gen5 NVMe or 16 x SATA 6Gb/s ◆ 3 x MCIO 8i for 6 x Gen5 NVMe ◆ 1 x MCIO 8i for 2 x Gen4 NVMe
		<p>M.2:</p> <ul style="list-style-type: none"> ◆ 1 x M.2 (2280/22110), PCIe Gen4 x4

	PCIe Expansion Slots	<ul style="list-style-type: none"> ◆ Slot_7: PCIe x16 (Gen5 x16) ◆ Slot_6: PCIe x16 (Gen5 x16) ◆ Slot_4: PCIe x16 (Gen5 x16) ◆ Slot_3: PCIe x16 (Gen5 x16) ◆ 2 x MCIO 8i (PCIe Gen5 x8 or SATA) ^[1] ◆ 3 x MCIO 8i (PCIe Gen5 x8) ^[1] ◆ 1 x MCIO 8i (PCIe Gen4 x8)
^[1] Please refer to the optional parts for qualified cables to ensure Gen5 signal quality.		
	On-Board Connector	<ul style="list-style-type: none"> ◆ 1 x 24-pin ATX main power connector ◆ 2 x 8-pin ATX 12V power connectors ◆ 1 x 6-pin ATX 12V power connector ◆ 1 x CPU fan header ◆ 5 x System fan headers ◆ 1 x USB 3.2 Gen1 x2 header ◆ 1 x USB 2.0 header ◆ 1 x M.2 slot ◆ 6 x MCIO 8i connectors ◆ 1 x Front panel header ◆ 1 x Backplane board header ◆ 1 x PMBus connector ◆ 1 x IPMB connector ◆ 1 x TPM header
	Rear I/O Connectors	<ul style="list-style-type: none"> ◆ 2 x USB 3.2 Gen1 ports (Type-A) ◆ 1 x VGA port ◆ 1 x COM port ◆ 2 x RJ45 ports ◆ 1 x MLAN port ◆ 1 x ID button with LED
	Security Modules	<ul style="list-style-type: none"> ◆ 1 x TPM header with SPI interface - Optional TPM2.0 kit: CTM012
	OS Driver Supported	<ul style="list-style-type: none"> ◆ Please refer to OS compatibility table in support page



Board Management

- ◆ Aspeed® AST2600 Baseboard Management Controller
- ◆ GIGABYTE Management Console web interface
- ◆
- ◆ Dashboard
- ◆ HTML5 KVM
- ◆ Sensor Monitor (Voltage, RPM, Temperature, CPU Status ...etc.)
- ◆ Sensor Reading History Data
- ◆ FRU Information
- ◆ SEL Log in Linear Storage / Circular Storage Policy
- ◆ Hardware Inventory
- ◆ Fan Profile
- ◆ System Firewall
- ◆ Power Consumption
- ◆ Power Control
- ◆ Advanced power capping
- ◆ LDAP / AD / RADIUS Support
- ◆ Backup & Restore Configuration
- ◆ Remote BIOS/BMC/CPLD Update
- ◆ Event Log Filter
- ◆ User Management
- ◆ Media Redirection Settings
- ◆ PAM Order Settings
- ◆ SSL Settings
- ◆ SMTP Settings



PSU Connector

- ◆ 1 x 24-pin ATX main power connector
- ◆ 2 x 8-pin ATX 12V power connectors
- ◆ 1 x 6-pin ATX 12V power connector



Operating Properties

- ◆ Operating temperature: 10°C to 40°C
- ◆ Operating humidity: 8-80% (non-condensing)
- ◆ Non-operating temperature: -40°C to 60°C
- ◆ Non-operating humidity: 20%-95% (non-condensing)

1-3 Installing and Removing the CPU and Heat Sink



Read the following guidelines before you begin to install the CPU:

- Make sure that the motherboard supports the CPU.
- Always turn off the computer and unplug the power cord from the power outlet before installing the CPU to prevent hardware damage.
- Unplug all cables from the power outlets.
- Disconnect all telecommunication cables from their ports.
- Place the system unit on a flat and stable surface.
- Open the system according to the instructions.



WARNING!

Failure to properly turn off the server before you start installing components may cause serious damage. Do not attempt the procedures described in the following sections unless you are a qualified service technician.

Follow these instructions to Install the CPU:

1. Loosen the captive screw securing the CPU cover.
2. Flip open the CPU cover.
3. Remove the CPU carrier from the CPU frame using the handle on the CPU carrier.
4. Using the handle on the CPU carrier insert the new CPU carrier with CPU installed into the CPU frame.

NOTE: Ensure the CPU is installed in the CPU carrier in the correct orientation, with the triangle on the CPU aligned to the top left corner of the CPU carrier.

5. Flip the CPU frame with CPU installed into place in the CPU socket.
6. Flip the CPU cover into place over the CPU socket.
7. Tighten the CPU cover screw to secure the CPU cover in place.

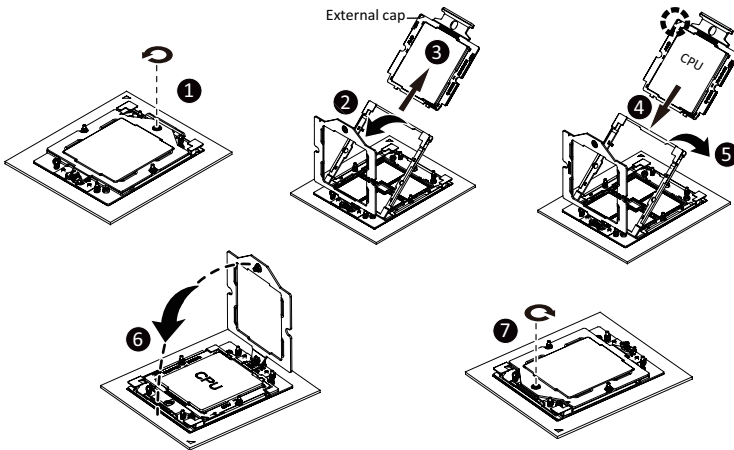

Note:

- Lock the CPU by using a Torx T20 screwdriver to tighten screw.
- The screw tightening torque: 13.5 ± 0.5 kgf-cm.

1-4 Installing and Removing Memory



Read the following guidelines before you begin to install the memory:

- Make sure that the motherboard supports the memory. It is recommended that memory of the same capacity, brand, speed, and chips be used.
- Always turn off the computer and unplug the power cord from the power outlet before installing the memory to prevent hardware damage.
- Memory modules have a foolproof design. A memory module can be installed in only one direction. If you are unable to insert the memory, switch the direction.

1-4-1 12-Channel Memory Configuration

This motherboard provides 24 DDR5 memory slots and supports 12-Channel Technology. After the memory is installed, the BIOS will automatically detect the specifications and capacity of the memory.

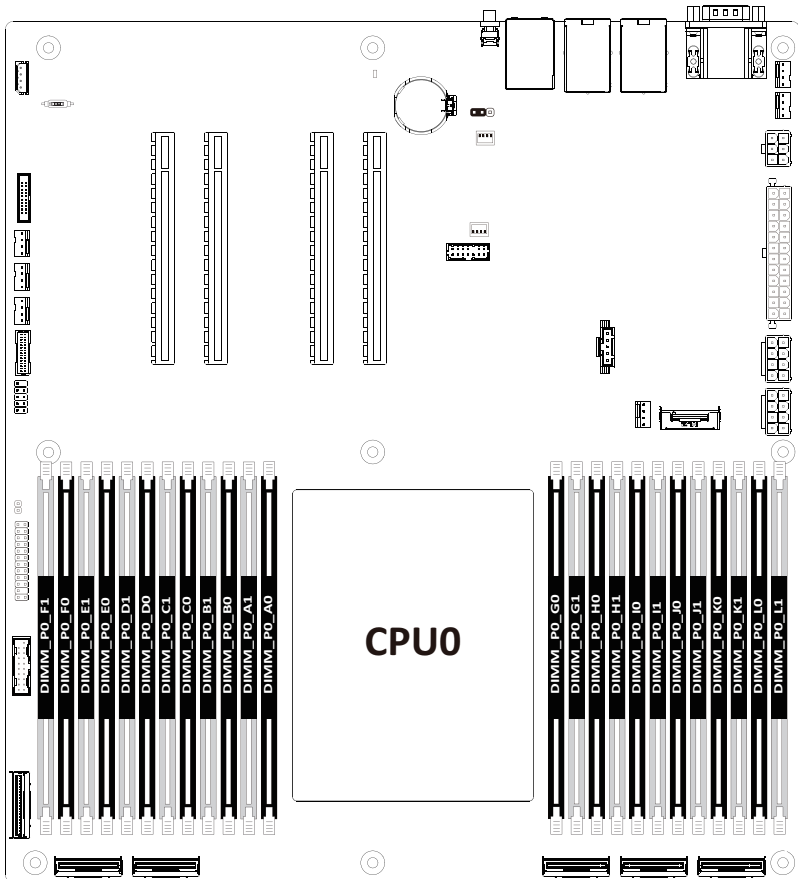

1-4-2 Installing and Removing the Memory Module



Before installing a memory module, make sure to turn off the computer and unplug the power cord from the power outlet to prevent damage to the memory module.

Be sure to install DDR5 DIMMs on to this motherboard.

Follow these instructions to install a DIMM module:

1. Insert the DIMM memory module vertically into the DIMM slot and push it down.
2. Close the plastic clip at both edges of the DIMM slots to lock the DIMM module.
3. Reverse the installation steps when you want to remove the DIMM module.

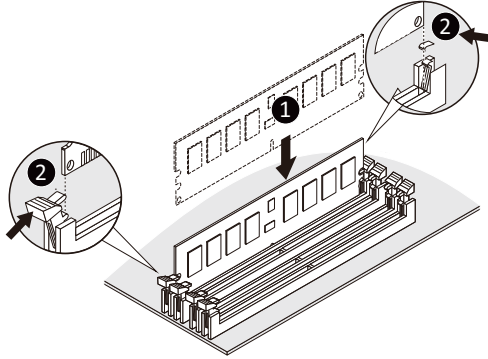

1-4-3 Processor and Memory Module Matrix Table

Memory Q'ty	CPU0																								
	F1	F0	E1	E0	D1	D0	C1	C0	B1	B0	A1	A0	G0	G1	H0	H1	I0	I1	J0	J1	K0	K1	L0	L1	
1 DIMM											v														
2 DIMM											v	v		v											
4 DIMM							v				v	v	v					v							
6 DIMM							v	v			v			v		v		v							
8 DIMM			v				v	v			v	v	v		v		v	v					v		
10 DIMM			v		v		v		v		v			v		v		v		v		v	v		
12 DIMM	v		v		v		v		v		v			v		v		v		v		v	v		v
16 DIMM			v	v			v	v	v	v	v	v	v	v	v	v	v	v					v	v	
20 DIMM			v	v	v	v	v	v	v	v	v	v	v	v	v	v	v	v	v	v	v	v	v	v	
24 DIMM	v	v	v	v	v	v	v	v	v	v	v	v	v	v	v	v	v	v	v	v	v	v	v	v	v

1-4-4 Memory Population Table

EPYC Memory Speed based on DIMM Population (One DIMM per Channel)

DIMM Type	DIMM Population	DDR5 Frequency MT/s ^{1,2}		
		6400 MT/s Grade DIMM ³	5600 MT/s Grade DIMM ³	4800 MT/s Grade DIMM ³
RDIMM	1R (1 rank)	6000	5600	4800
	2R (2 ranks)	6000	5600	4800
3DS RDIMM*	2R xH	6000 ⁴	5600	4800
MRDIMM (1:1) ⁵	4R (4 ranks)	6000 ⁴		

*For 3DS RDIMM	When x = 2	DIMM Ranks = 4
	When x =4	DIMM Ranks = 8
	When x = 8 ⁵	DIMM Ranks = 16

Note:

- When only one DIMM is used, it must be populated in memory slot DIMM1.
1. Frequency subject to change based on validation.
 2. Maximum frequency references 14L 74mil low-Dk PCB stackup.
 3. 6000 MT/s pending ecosystem enablement.
 4. MRDIMM will be evaluated as a post-PR feature, pending ecosystem readiness.
 5. 3DS RDIMM at 2 Rank (8H DRAM Pkgs) will be a post-PR feature, pending ecosystem readiness.

EPYC Memory Speed based on DIMM Population (Two DIMM per Channel)

DIMM Type	DIMM Population		DDR5 Frequency MT/s ^{1,2,3}		
	DIMM0	DIMM1	6400 MT/s Grade DIMM	5600 MT/s Grade DIMM	4800 MT/s Grade DIMM
RDIMM	--	1R	5200	4800	4800
	1R	1R	4400	4000	4000
	--	2R	5200	4800	4800
	2R	2R	4000	3600	3600
3DS RDIMM*	--	2R xH	5200	4800	4800
	2R xH	2R xH	4000	3600	3600

*For 3DS RDIMM	When x = 2	DIMM Ranks = 4
	When x =4	DIMM Ranks = 8
	When x = 8 ⁴	DIMM Ranks = 16

Note:

- When only one DIMM is used, it must be populated in memory slot DIMM1.
1. Frequency subject to change based on validation.
 2. Maximum frequency references 14L 74mil low-Dk PCB stackup.
 3. 62DPC (2-of-2) mixing of DIMM, RCD, and/or PMIC vendor within a memory channel to be supported for 6400 MT/s speed-grade DIMMs only, beginning in TurinPI-SP5_1.0.0.0..
 4. 3DS RDIMM at 2 Rank (8H DRAM Pkgs) will be a post-PR feature, pending ecosystem readiness.

1-5 Installing and Removing the M.2 SSD Module



CAUTION

The position of the stand-off screw will depend on the size of the M.2 device. The stand-off screw is pre-installed for 22110 cards as standard. Refer to the size of the M.2 device and change the position of the stand-off screw accordingly.

Follow the steps below to install an optional M.2 SSD module on your motherboard:

Step1. Insert the M.2 SSD module into the slot.

Step2. Secure it with the screw, tightening as necessary to fasten the M.2 SSD module in place.

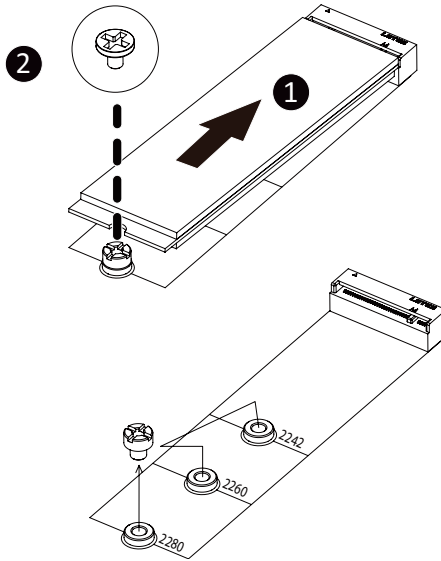

1-6 Back Panel Connectors

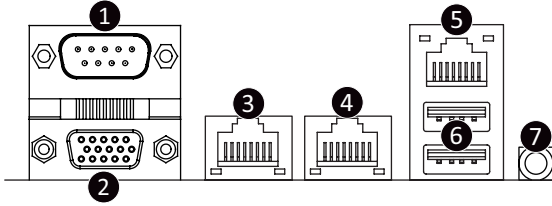

1 Serial Port

Connect to serial-based mouse or data processing devices.

2 VGA Port

Connect to a monitor device.

3 10GbE LAN Port #2

The Gigabit Ethernet LAN port provides Internet connection at up to 10 Gbps data rate. See the section below for a description of the states of the LAN port LEDs.

4 10GbE LAN Port #1

The Gigabit Ethernet LAN port provides Internet connection at up to 10 Gbps data rate. See the section below for a description of the states of the LAN port LEDs.

5 Server Management LAN Port

The LAN port provides Internet connection with data transfer speeds of 10/100/1000Mbps. This port is the dedicated LAN port for Server Management.

6 USB 3.2 Gen1 Ports

The USB port supports the USB 3.2 specification. Use this port for USB devices such as a USB keyboard/mouse, USB printer, USB flash drive etc.

7 ID button with LED

When the system identification is active, the ID LED on the front/ back panel glows blue.

LAN and ID Button LEDs

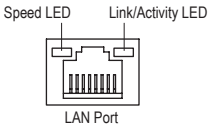

10GbE LAN LED:

State	Description
Yellow On	5Gbps, 2.5Gbps, 1Gps data rate
Green On	10Gbps data rate
Off	100Mbps data rate

10/100/1000 LAN LED:

State	Description
Yellow On	1Gbps data rate
Green On	100Mbps data rate
Off	10Mbps data rate

ID button/LED:

State	Description
Blue On	System identification is active
Off	System identification is disabled



- When removing the cable connected to a back panel connector, first remove the cable from your device and then remove it from the motherboard.
- When removing the cable, pull it straight out from the connector. Do not rock it side to side to prevent an electrical short inside the cable connector.

1-7 Internal Connectors

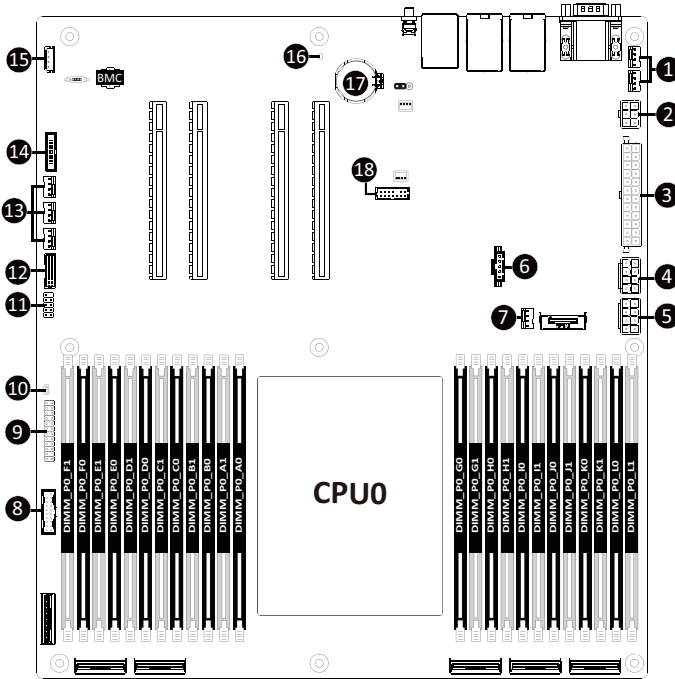

1) SYS_FAN4 / SYS_FAN5	11) F_USB2
2) P12V_PCIE	12) BP_1
3) ATX1	13) SYS_FAN1 / SYS_FAN2 / SYS_FAN3
4) P12V_AUX2	14) CN_NCSI
5) P12V_AUX1	15) IPMB
6) PMBUS	16) LED_BMC
7) CPU0_FAN1	17) BAT
8) F_USB3	18) SPI_TPM
9) FP_1	
10) CASE_OPEN	



Read the following guidelines before connecting external devices:

- First make sure your devices are compliant with the connectors you wish to connect.
- Before installing the devices, be sure to turn off the devices and your computer. Unplug the power cord from the power outlet to prevent damage to the devices.
- After installing the device and before turning on the computer, make sure the device cable has been securely attached to the connector on the motherboard.

1/7/13) SYS_FAN4/SYS_FAN5/CPU0_FAN1/SYS_FAN1/SYS_FAN2/SYS_FAN3

(FAN Headers)

The motherboard has one 4-pin CPU fan header (CPU_FAN), and five 4-pin (SYS_FAN) system fan headers. Most fan headers possess a foolproof insertion design. When connecting a fan cable, be sure to connect it in the correct orientation (the black connector wire is the ground wire). The motherboard supports CPU fan speed control, which requires the use of a CPU fan with fan speed control design. For optimum heat dissipation, it is recommended that a system fan be installed inside the chassis.

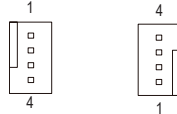
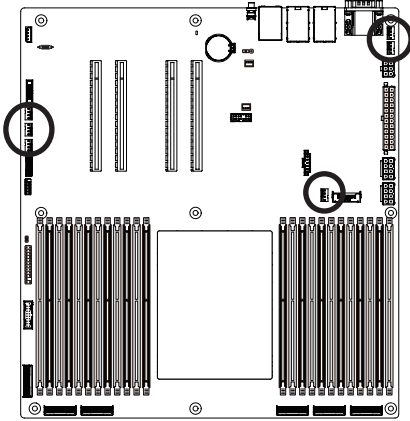

Pin No.	Definition
1	GND
2	+12V
3	Sense
4	Speed Control



- Be sure to connect fan cables to the fan headers to prevent your CPU and system from overheating. Overheating may result in damage to the CPU or the system may hang.
- These fan headers are not configuration jumper blocks. Do not place a jumper cap on the headers.

6) PMBus Connector

The Power Management Bus (PMBus) is a variant of the System Management Bus (SMBus) which is targeted at digital management of power supplies.

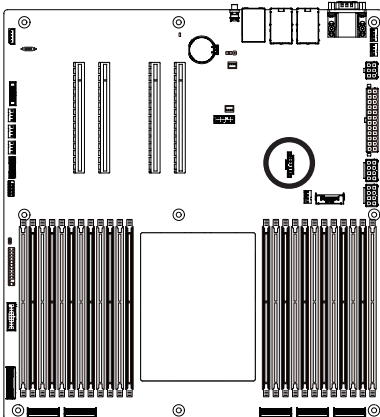

Pin No.	Definition
1	PMBus Clock
2	PMBus Data
3	PMBus Alert
4	GND
5	3.3V Sense

2/3/4/5) P12V_PCIE/ATX1/P12V_AUX2/P12V_AUX1

(2x4/2x3 12V Power Connector and 2x12 Main Power Connector)

With the use of the power connector, the power supply can supply enough stable power to all the components on the motherboard. Before connecting the power connector, first make sure the power supply is turned off and all devices are properly installed. The power connector possesses a foolproof design. Connect the power supply cable to the power connector in the correct orientation. The 12V power connector mainly supplies power to the CPU. If the 12V power connector is not connected, the computer will not start.



To meet expansion requirements, it is recommended that a power supply that can withstand high power consumption be used (500W or greater). If a power supply is used that does not provide the required power, the result can lead to an unstable or unbootable system.

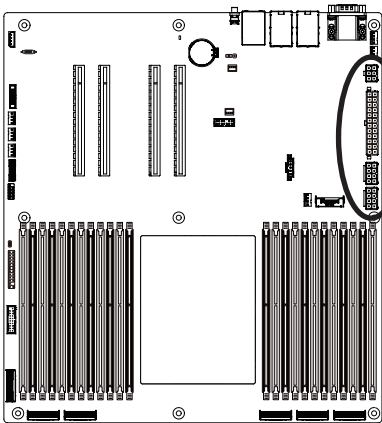

ATX1

Pin No.	Definition	Pin No.	Definition
1	3.3V	13	3.3V
2	3.3V	14	-12V
3	GND	15	GND
4	+5V	16	PS_ON
5	GND	17	GND
6	+5V	18	GND
7	GND	19	GND
8	Power Good	20	-5V
9	5VSB	21	+5V
10	+12V	22	+5V
11	+12V	23	+5V
12	3.3V	24	GND

P12V_PCIE



Pin No.	Definition
1	+12V
2	+12V
3	+12V
4	GND
5	GND
6	GND

P12V_AUX1/P12V_AUX2



Pin No.	Definition
1	GND
2	GND
3	GND
4	GND
5	+12V
6	+12V
7	+12V
8	+12V

8/11) F_USB3/ F_USB2 (USB 3.2 Gen1 Connector/ USB 2.0 Header)

The connector/header conform to USB 2.0/ 3.0 specification. Each USB connector/header can provide two USB ports via an optional USB bracket. For purchasing the optional USB bracket, please contact the local dealer.

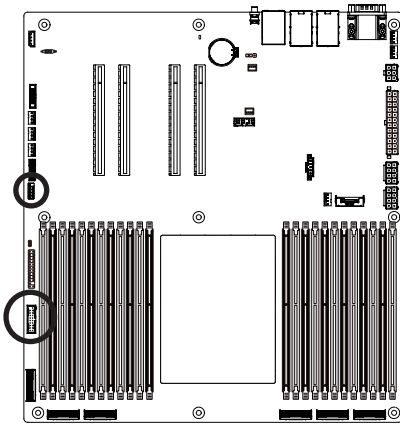

USB 2.0 Header

Pin No.	Definition	Pin No.	Definition
1	Power (5V)	6	USB DY+
2	Power (5V)	7	GND
3	USB DX-	8	GND
4	USB DY-	9	No Pin
5	USB DX+	10	No Connect

USB 3.2 Connector

Pin No.	Definition	Pin No.	Definition
1	Power	11	IntA_P2_D+
2	IntA_P1_SSRX-	12	IntA_P2_D-
3	IntA_P1_SSRX+	13	GND
4	GND	14	IntA_P2_SSTX+
5	IntA_P1_SSTX-	15	IntA_P2_SSTX-
6	IntA_P1_SSTX+	16	GND
7	GND	17	IntA_P2_SSRX+
8	IntA_P1_D-	18	IntA_P2_SSRX-
9	IntA_P1_D+	19	Power
10	NC	20	No Pin

9) FP_1 (Front Panel Header)

Connect the power switch, reset switch, speaker, chassis intrusion switch/sensor and system status indicator on the chassis to this header according to the pin assignments below. Note the positive and negative pins before connecting the cables.

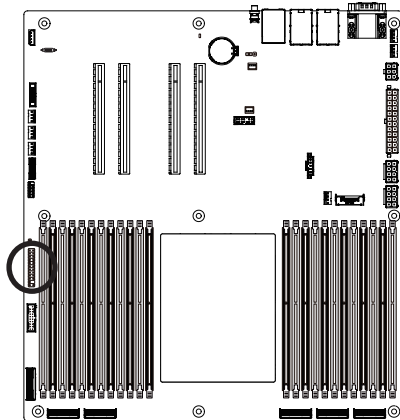

Pin No.	Definition	Pin No.	Definition
1	Power LED+	2	5V Standby
3	No Pin	4	ID LED+
5	Power LED-	6	ID LED-
7*	HDD LED+	8	System Status LED+
9*	HDD LED-	10	System Status LED-
11	Power Button	12	LAN1 Active LED+
13	GND	14	LAN1 Link LED-
15	Reset Button	16	SMBus Data
17	GND	18	SMBus Clock
19	ID Button	20	Case Open
21	GND	22	LAN2 Active LED+
23	NMI Switch	24	LAN2 Link LED-

*Note: Pin 7 & Pin 9 are reserved for Gigabyte systems.



The front panel design may differ by chassis. A front panel module mainly consists of power switch, reset switch, power LED, hard drive activity LED, speaker etc. When connecting your chassis front panel module to this header, make sure the wire assignments and the pin assignments are matched correctly.

10) CASE_OPEN (Case Open Intrusion Alert Header)

This motherboard provides a chassis detection feature that detects if the chassis cover has been removed. This function requires a chassis with chassis intrusion detection design.

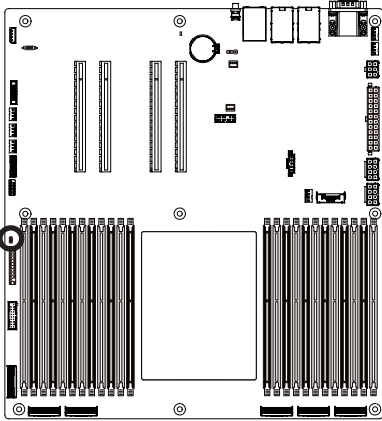

- Open: Normal Operation (Default)
- Closed: Active Chassis Intrusion Alert

12) BP_1 (HDD Backplane Board Header)

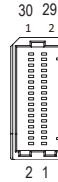
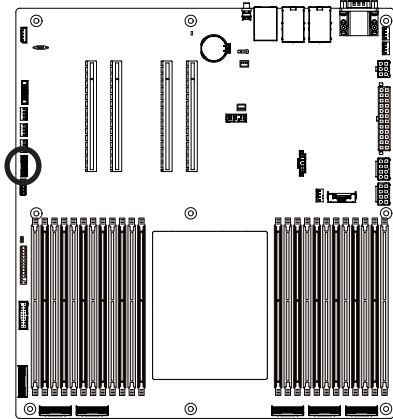

Pin No.	Definition	Pin No.	Definition
1	HP_ALERT_L	2	BPMI DIN/OUT
3	GND	4	BPMI DIN/IN
5	BPMI_LOAD	6	GND
7	BPMI_CLK	8	PLD_Program_EN
9	GLED_AMB_N	10	GLED_GRN_N
11	FAN_IRQ_N	12	Reserved
13	BP_SCL	14	GND
15	BP_SDA	16	BP_RST_N
17	SMB_U2_TMP_SCL	18	GND
19	SMB_U2_TMP_SDA	20	I2C_DEV_RST
21	PH_HP_SCL0	22	GND
23	PH_HP_SDA0	24	GND
25	PH_HP_SCL1	26	GND
27	PH_HP_SDA1	28	GND
15	P3V3_AUX	30	P3V3_AUX

14) CN_NCSI (NCSI Connector)

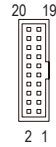
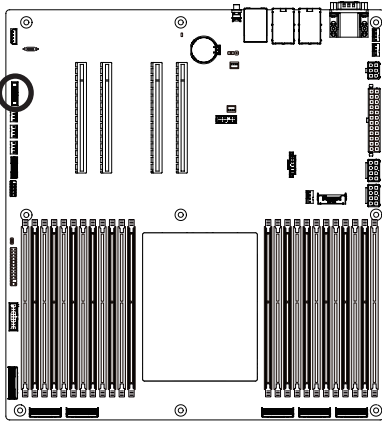

Pin No.	Definition	Pin No.	Definition
1	NCSI_CLK	2	GND
3	NCSI_RX_D0	4	GND
5	NCSI_RX_D1	6	GND
7	NCSI_CRD_DV	8	GND
9	NCSI_RX_ER	10	GND
11	P3V3_AUX	12	GND
13	NCSI_TX_D1	14	GND
15	NCSI_TX_D0	16	GND
17	NCSI_TX_EN	18	GND
19	NCSI_PRESENT	20	P3V3_AUX

15) IPMB (Intelligent Platform Management Bus) Connector

The Intelligent Platform Management Bus Communications Protocol defines a byte-level transport for transferring Intelligent Platform Management Interface Specification (IPMI) messages between intelligent I2C devices.

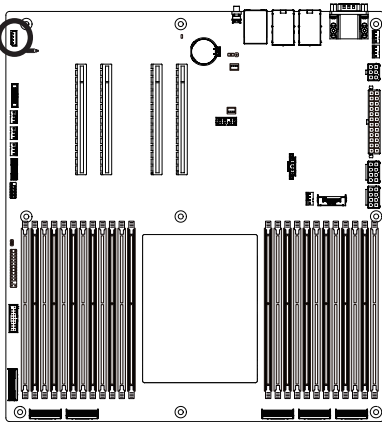

Pin No.	Definition
1	Clock
2	GND
3	Data
4	VCC

16) LED_BMC (BMC Firmware Readiness LED)

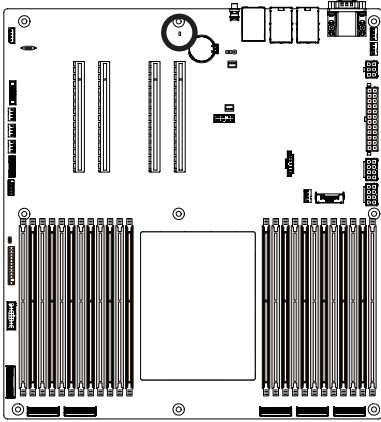

State	Description
On	BMC firmware is initial
Blink	BMC firmware is ready
Off	AC loss

17) BAT (Battery Socket)

The battery provides power to keep the values (such as BIOS configurations, date, and time information) in the CMOS when the computer is turned off. Replace the battery when the battery voltage drops to a low level, or the CMOS values may not be accurate or may be lost.

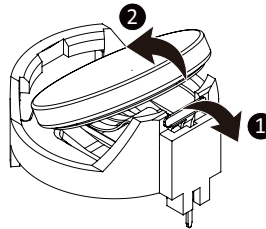
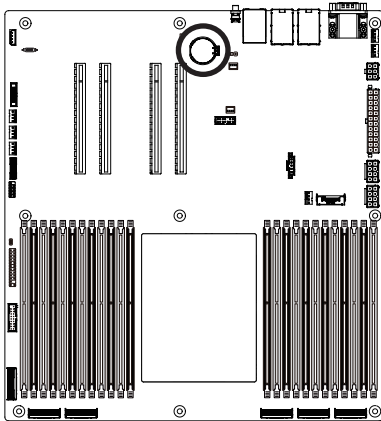

- Always turn off your computer and unplug the power cord before replacing the battery.
- Replace the battery with an equivalent one. Danger of explosion if the battery is replaced with an incorrect model.
- Contact the place of purchase or local dealer if you are not able to replace the battery by yourself or uncertain about the battery model.
- Used batteries must be handled in accordance with local environmental regulations.

18) SPI_TPM (Trusted Platform Module Connector)

Trusted Platform Module (TPM) is an international standard for a secure cryptoprocessor, a dedicated microcontroller designed to secure hardware through integrated cryptographic keys.

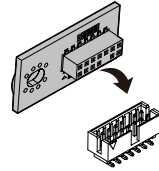
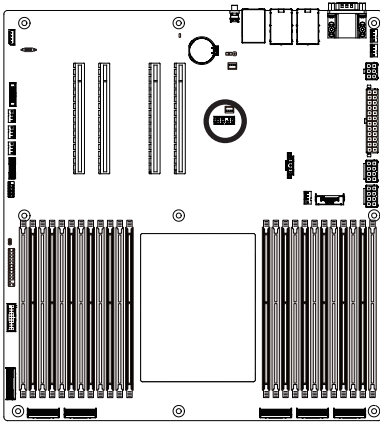

Pin No.	Definition	Pin No.	Definition
1	Clock	8	NC
2	P_3V3_AUX	9	NC
3	LPC_RST	10	No Pin
4	NC	11	NC
5	SPI_MISO	12	GND
6	IRQ_SPI	13	SPI_CS_N
7	SPI_MOSI	14	GND

1-8 Jumper Settings

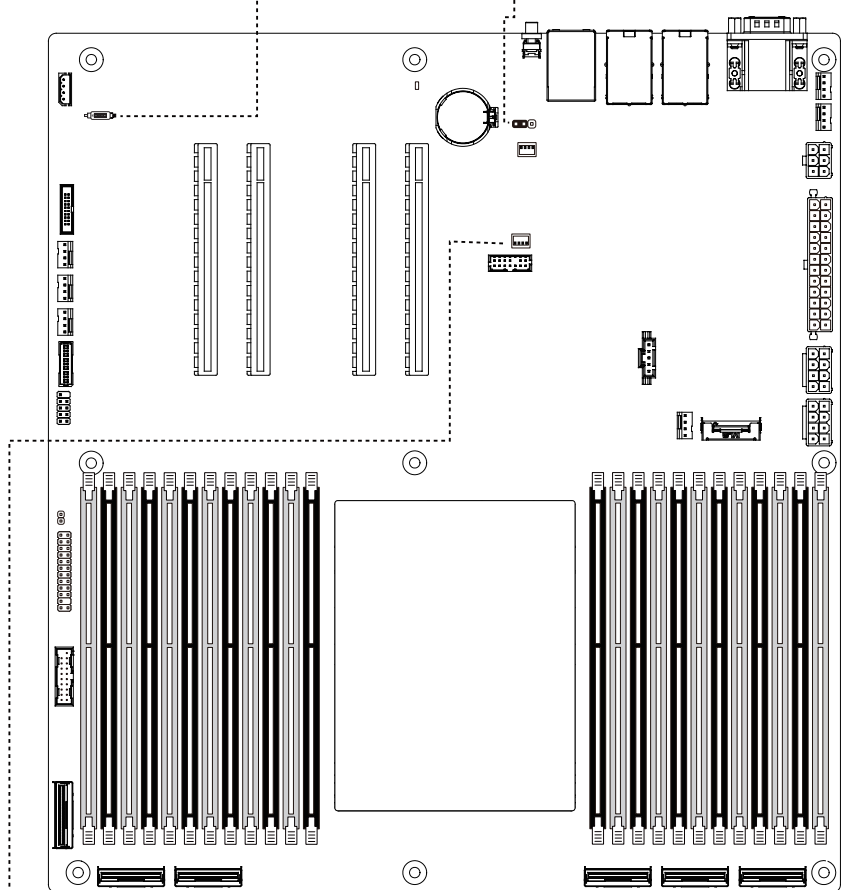
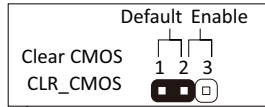
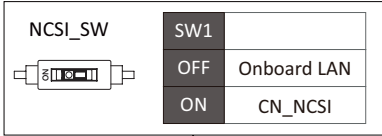

J1		ON	OFF
1	HSMB_SEL	BIOS Defined	
2	PMBUS_SEL	BIOS Defined	
3	BIOS_PWD	Clear supervisor password	Normal [Default]
4	BIOS_RCVR	BIOS recovery mode	Normal [Default]

Chapter 2 BIOS Setup

BIOS (Basic Input and Output System) records hardware parameters of the system in the EFI on the motherboard. Its major functions include conducting the Power-On Self-Test (POST) during system startup, saving system parameters, loading the operating system etc. The BIOS includes a BIOS Setup program that allows the user to modify basic system configuration settings or to activate certain system features. When the power is turned off, the battery on the motherboard supplies the necessary power to the CMOS to keep the configuration values in the CMOS.

To access the BIOS Setup program, press the key during the POST when the power is turned on.



- BIOS flashing is potentially risky, if you do not encounter any problems when using the current BIOS version, it is recommended that you don't flash the BIOS. To flash the BIOS, do it with caution. Inadequate BIOS flashing may result in system malfunction.
- It is recommended that you not alter the default settings (unless you need to) to prevent system instability or other unexpected results. Inadequately altering the settings may result in system's failure to boot. If this occurs, try to clear the CMOS values and reset the board to default values. (Refer to the **Exit** section in this chapter or introductions of the battery/clearing CMOS jumper in Chapter 1 for how to clear the CMOS values.)

BIOS Setup Program Function Keys

<<-><->>	Move the selection bar to select the screen
<↑><↓>	Move the selection bar to select an item
<+>	Increase the numeric value or make changes
<->	Decrease the numeric value or make changes
<Enter>	Execute command or enter the submenu
<Esc>	Main Menu: Exit the BIOS Setup program Submenus: Exit current submenu
<F1>	Show descriptions of general help
<F3>	Restore the previous BIOS settings for the current submenus
<F9>	Load the Optimized BIOS default settings for the current submenus
<F10>	Save all the changes and exit the BIOS Setup program

■ **Main**

This setup page includes all the items of the standard compatible BIOS.

■ **Advanced**

This setup page includes all the items of AMI BIOS special enhanced features.

(ex: Auto detect fan and temperature status, automatically configure hard disk parameters.)

■ **AMD CBS**

This setup page includes the common items for configuration of AMD motherboard-related information.

■ **AMD PBS Option**

This setup page includes the common items for configuration of AMD CPM RAS related settings.

■ **Chipset**

This setup page includes all the submenu options for configuring the functions of the North Bridge.

■ **Server Management**

Server additional features enabled/disabled setup menus.

■ **Security**

Change, set, or disable supervisor and user password. Configuration supervisor password allows you to restrict access to the system and BIOS Setup.

A supervisor password allows you to make changes in BIOS Setup.

A user password only allows you to view the BIOS settings but not to make changes.

■ **Boot**

This setup page provides items for configuration of the boot sequence.

■ **Save & Exit**

Save all the changes made in the BIOS Setup program to the CMOS and exit BIOS Setup. (Pressing <F10> can also carry out this task.)

Abandon all changes and the previous settings remain in effect. Pressing <Y> to the confirmation message will exit BIOS Setup. (Pressing <Esc> can also carry out this task.)

2-1 The Main Menu

Once you enter the BIOS Setup program, the Main Menu (as shown below) appears on the screen. Use arrow keys to move among the items and press <Enter> to accept or enter other sub-menu.

Main Menu Help

The on-screen description of a highlighted setup option is displayed on the bottom line of the Main Menu.

Submenu Help

While in a submenu, press <F1> to display a help screen (General Help) of function keys available for the menu. Press <Esc> to exit the help screen. Help for each item is in the Item Help block on the right side of the submenu.



- When the system is not stable as usual, select the **Restore Defaults** item to set your system to its defaults.
- The BIOS Setup menus described in this chapter are for reference only and may differ by BIOS version.

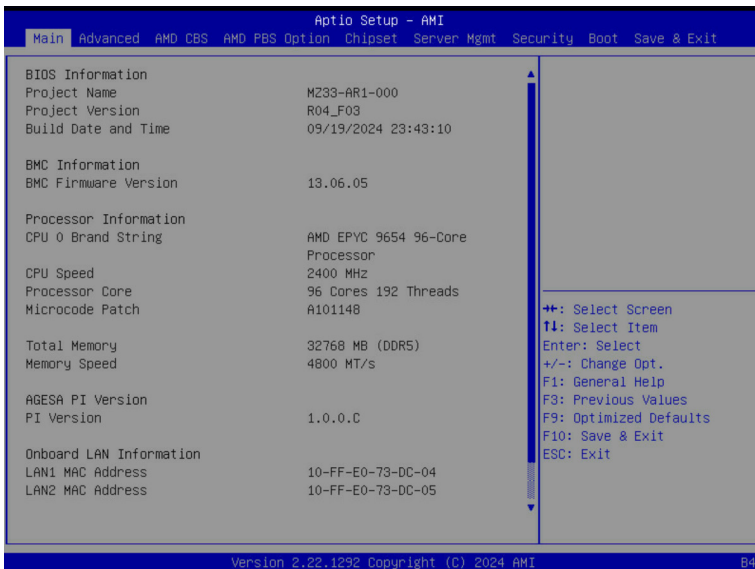

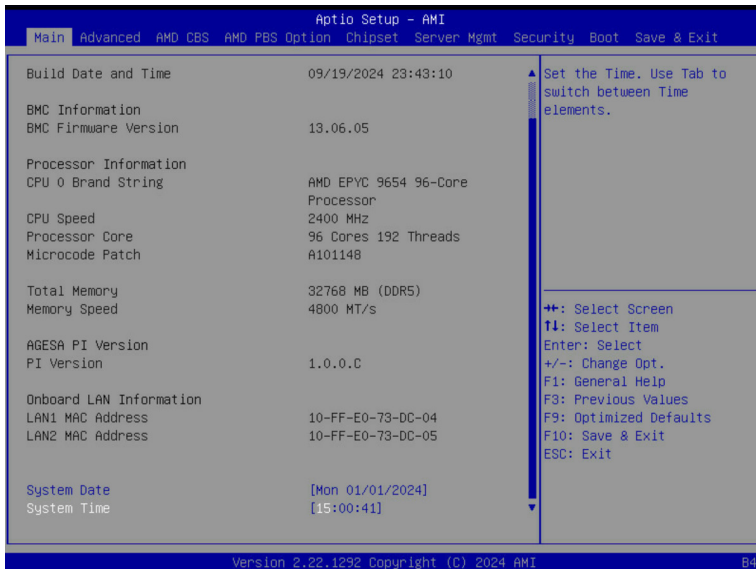

Parameter	Description
BIOS Information	
Project Name	Displays the project name information.
Project Version	Displays version number of the BIOS setup utility.
Build Date and Time	Displays the date and time when the BIOS setup utility was created.
BMC Information ^(Note1)	
BMC Firmware Version ^(Note1)	Displays BMC firmware version information.
Processor Information	
CPU Brand String / CPU Speed / Processor Core / Microcode Patch	Displays the technical specifications for the installed processor(s).
Total Memory ^(Note2)	Displays the total memory size of the installed memory.
Memory Speed ^(Note2)	Displays the frequency information of the installed memory.
VR Information Version	Displays VR version information.
AGESA PI Version	
PI Version	Displays AGESA PI version information.

(Note1) Functions available on selected models.

(Note2) This section will display capacity and frequency information of the memory that the customer has installed.

Parameter	Description
Onboard LAN Information	
LAN1 MAC Address ^(Note)	Displays LAN MAC address information.
LAN2 MAC Address ^(Note)	Displays LAN MAC address information.
System Date	Sets the date following the weekday-month-day-year format.
System Time	Sets the system time following the hour-minute-second format.

(Note) The number of LAN ports listed will depend on the motherboard / system model.

2-2 Advanced Menu

The Advanced Menu displays submenu options for configuring the function of various hardware components. Select a submenu item, then press <Enter> to access the related submenu screen.

When Boot Mode Select is set to UEFI (Default)

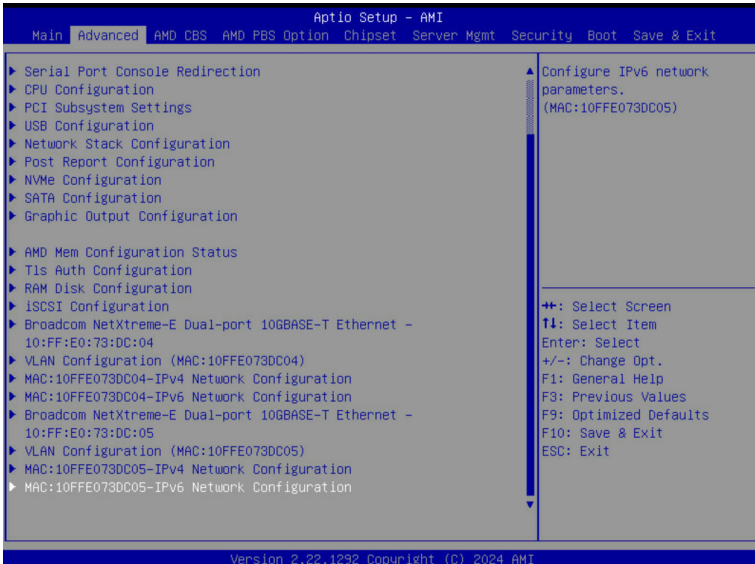
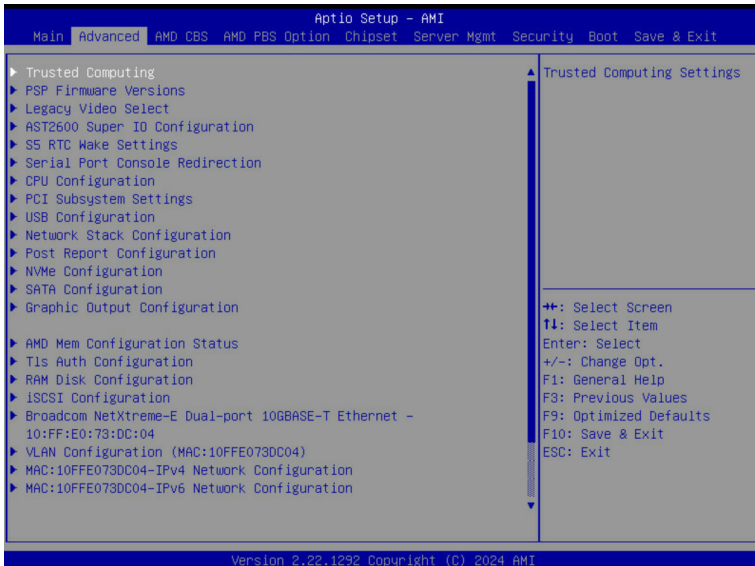

When "Boot Mode Select" is set to Legacy in the Boot > Boot Mode Select section

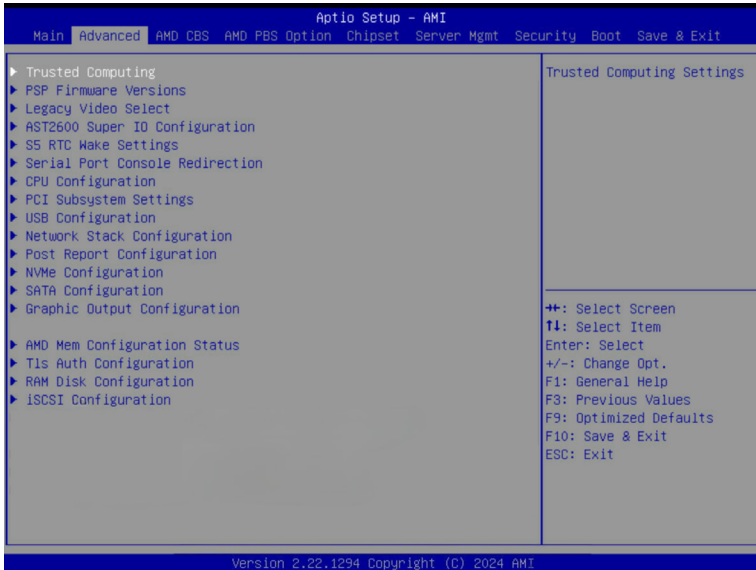

2-2-1 Trusted Computing

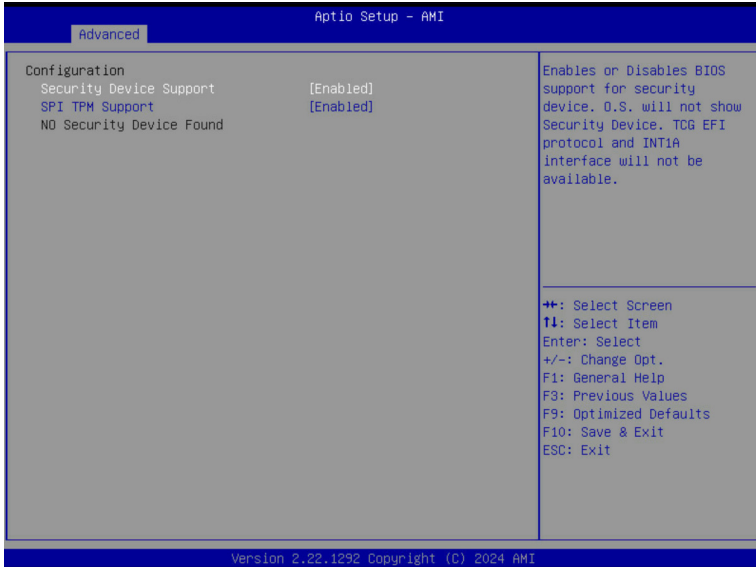

Parameter	Description
Configuration	
Security Device Support	<p>Enable/Disable BIOS support for security device. OS will not show security device. TCG EFI protocol and INT1A interface will not be available.</p> <p>Options available: Disable, Enable. Default setting is Enable.</p>
SPI TPM Support	<p>Select Enable to activate TPM support feature.</p> <p>Options available: Disabled, Enabled. Default setting is Disabled.</p>

2-2-2 PSP Firmware Versions

The PSP Firmware Versions page displays the basic PSP firmware version information. Items on this window are non-configurable.

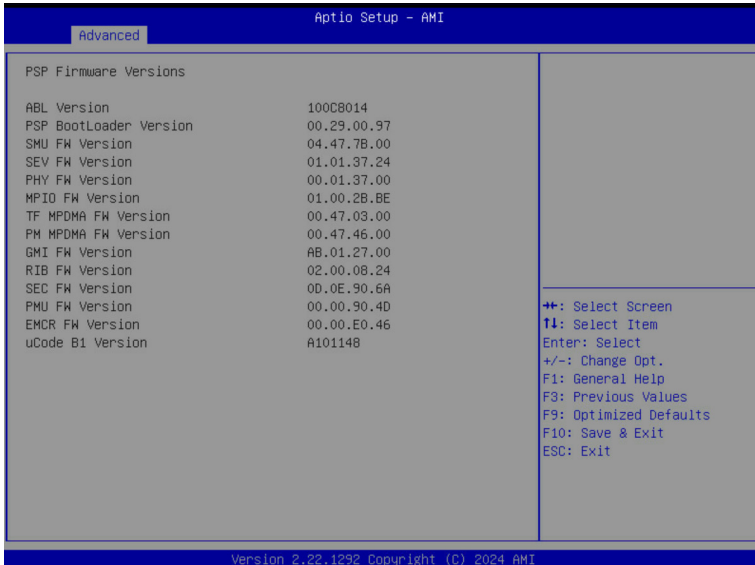

2-2-3 Legacy Video Select

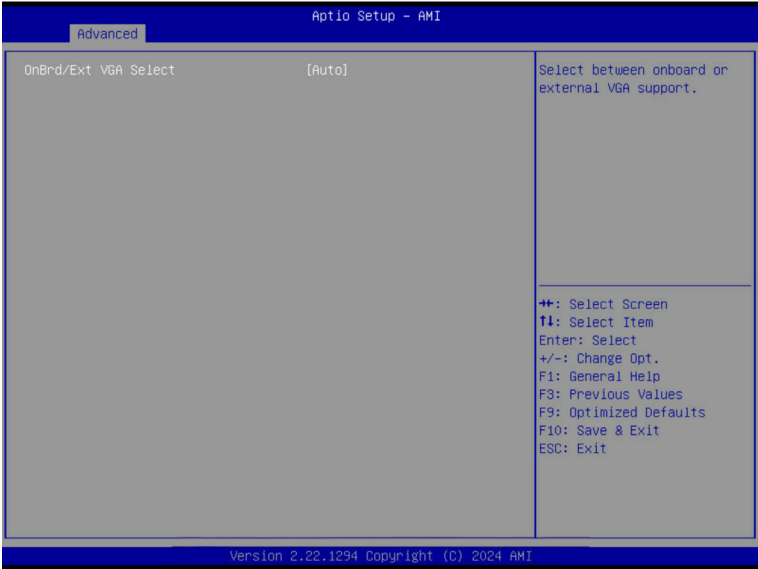

Parameter	Description
OnBrd/Ext VGA Select	Selects between onboard or external VGA support. Options available: Auto, Onboard, External. Default setting is Auto .

(Note) This configurable option will be displayed when "Boot Mode Select" is set to Legacy in the Boot > Boot Mode Select section.

2-2-4 AST2600 Super IO Configuration

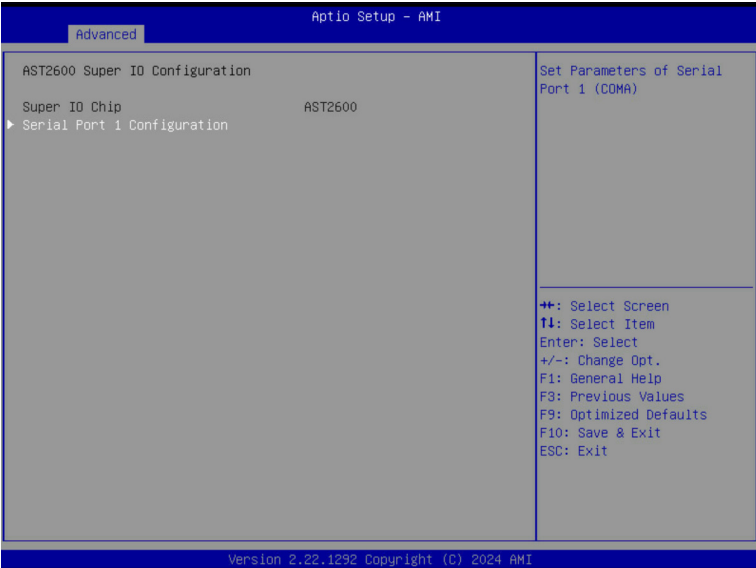

Parameter	Description
AST2600 Super IO Configuration	
Super IO Chip	Displays the super IO chip information
Serial Port 1 Configuration	Press [Enter] for configuration of advanced items.

2-2-4-1 Serial Port 1 Configuration

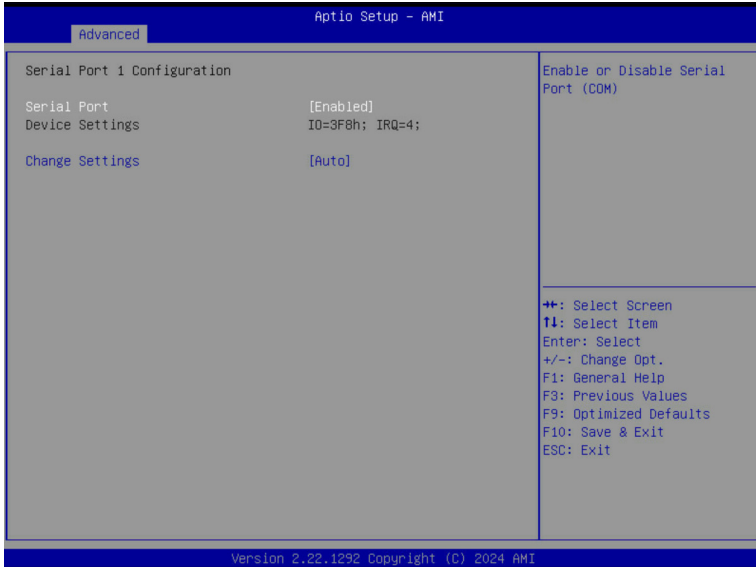

Parameter	Description
Serial Port 1 Configuration	
Serial Port ^(Note)	Enable/Disable the Serial Port (COM). When set to Enabled allows you to configure the Serial port 1 settings. When set to Disabled, displays no configuration for the serial port. Options available: Disabled, Enabled. Default setting is Enabled .
Devices Settings	Displays the Serial Port 1 device settings.
Change Settings	Select an optimal settings for Super IO Device. Options available for Serial Port 1: Auto IO=3F8h; IRQ=4; IO=3F8h; IRQ=3, 4, 5, 6, 7, 9, 10, 11, 12; IO=2F8h; IRQ=3, 4, 5, 6, 7, 9, 10, 11, 12; IO=3E8h; IRQ=3, 4, 5, 6, 7, 9, 10, 11, 12; IO=2E8h; IRQ=3, 4, 5, 6, 7, 9, 10, 11, 12; Default setting is Auto .

(Note) Advanced items prompt when this item is defined.

2-2-5 S5 RTC Wake Settings



Parameter	Description
Wake System from S5	Enable/Disable system wake on alarm event. Options available: Disabled, Fixed Time, Dynamic Time. When Fixed Time is selected, system will wake on the hr::min::sec specified. Default setting is Disabled .

2-2-6 Serial Port Console Redirection

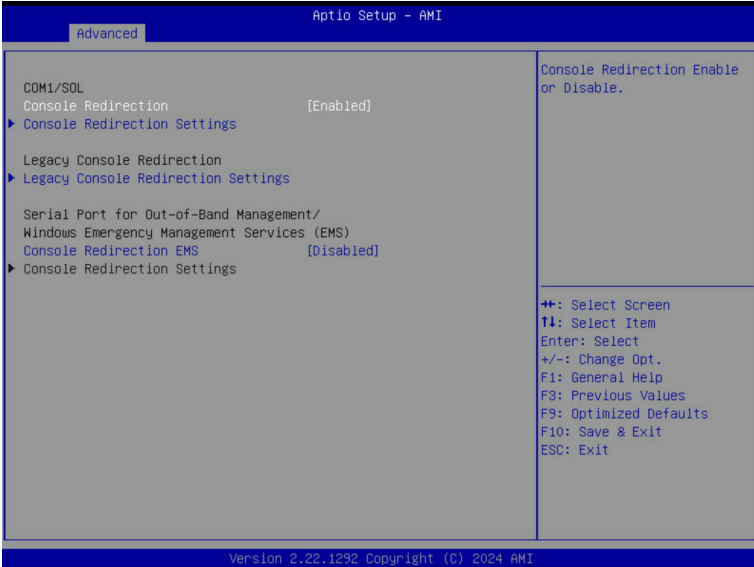

Parameter	Description
COM1/Serial Over LAN Console Redirection ^(Note)	<p>Select whether to enable console redirection for specified device. Console redirection enables the users to manage the system from a remote location.</p> <p>Options available: Enabled, Disabled. Default setting is Disabled.</p>
COM1/Serial Over LAN Console Redirection Settings	<p>Press [Enter] to configure advanced items.</p> <p>Please note that this item is configurable when COM1/Serial Over LAN Console Redirection is set to Enabled.</p> <ul style="list-style-type: none"> ◆ Terminal Type <ul style="list-style-type: none"> – Selects a terminal type to be used for console redirection. – Options available: VT100, VT100+, ANSI, VT-UTF8. Default setting is ANSI. ◆ Bits per second <ul style="list-style-type: none"> – Selects the transfer rate for console redirection. – Options available: 9600, 19200, 38400, 57600, 115200. Default setting is 115200. ◆ Data Bits <ul style="list-style-type: none"> – Selects the number of data bits used for console redirection. – Options available: 7, 8. Default setting is 8.

(Note) Advanced items prompt when this item is defined.

Parameter	Description
COM1/Serial Over LAN Console Redirection Settings (continued)	<ul style="list-style-type: none"> ◆ Parity <ul style="list-style-type: none"> – A parity bit can be sent with the data bits to detect some transmission errors. – Even: parity bit is 0 if the num of 1's in the data bits is even. – Odd: parity bit is 0 if num of 1's in the data bits is odd. – Mark: parity bit is always 1. Space: Parity bit is always 0. – Mark and Space Parity do not allow for error detection. – Options available: None, Even, Odd, Mark, Space. Default setting is None. ◆ Stop Bits <ul style="list-style-type: none"> – Stop bits indicate the end of a serial data packet. (A start bit indicates the beginning). The standard setting is 1 stop bit. Communication with slow devices may require more than 1 stop bit. – Options available: 1, 2. Default setting is 1. ◆ Flow Control <ul style="list-style-type: none"> – Flow control can prevent data loss from buffer overflow. When sending data, if the receiving buffers are full, a 'stop' signal can be sent to stop the data flow. Once the buffers are empty, a 'start' signal can be sent to re-start the flow. Hardware flow control uses two wires to send start/stop signals. – Options available: None, Hardware RTS/CTS. Default setting is None. ◆ VT-UTF8 Combo Key Support <ul style="list-style-type: none"> – Enable/Disable the VT-UTF8 Combo Key Support. – Options available: Enabled, Disabled. Default setting is Enabled. ◆ Recorder Mode <ul style="list-style-type: none"> – When this mode enabled, only texts will be send. This is to capture Terminal data. – Options available: Enabled, Disabled. Default setting is Disabled. ◆ Resolution 100x31 <ul style="list-style-type: none"> – Enable/Disable extended terminal resolution. – Options available: Enabled, Disabled. Default setting is Enabled. ◆ Putty KeyPad <ul style="list-style-type: none"> – Selects Function Key and KeyPad on Putty. – Options available: VT100, LINUX, XTERMR6, SC0, ESCN, VT400. Default setting is VT100.

Parameter	Description
Legacy Console Redirection	
Legacy Console Redirection Settings	<p>Press [Enter] to configure advanced items.</p> <ul style="list-style-type: none"> ◆ Redirection COM Port <ul style="list-style-type: none"> – Selects a COM port for Legacy serial redirection. – Default setting is COM1/SOL. ◆ Resolution <ul style="list-style-type: none"> – Selects the number of rows and columns used in Console Redirection for legacy OS support. – Options available: 80x24, 80x25. Default setting is 80x24. ◆ Redirect After POST <ul style="list-style-type: none"> – When Bootloader is selected, then Legacy Console Redirection is disabled before booting to legacy OS. When Always Enable is selected, then Legacy Console Redirection is enabled for legacy OS. – Options available: Always Enable, BootLoader. Default setting is Always Enable.
Serial Port for Out-of-Band Management / Windows Emergency Management Services (EMS) Console Redirection ^(Note)	<p>EMS console redirection allows the user to configure Console Redirection Settings to support Out-of-Band Serial Port management.</p> <p>Options available: Disabled, Enabled. Default setting is Disabled.</p>
Serial Port for Out-of-Band EMS Console Redirection Settings	<p>Press [Enter] to configure advanced items.</p> <p>Please note that this item is configurable when Serial Port for Out-of-Band Management EMS Console Redirection is set to Enabled.</p> <ul style="list-style-type: none"> ◆ Out-of-Band Mgmt Port <ul style="list-style-type: none"> – Microsoft Windows Emergency Management Service (EMS) allows for remote management of a Windows Server OS through a serial port. – Default setting is COM1/SOL. ◆ Terminal Type <ul style="list-style-type: none"> – Selects a terminal type to be used for console redirection. – Options available: VT100, VT100+, ANSI, VT-UTF8. Default setting is ANSI. ◆ Bits per second <ul style="list-style-type: none"> – Selects the transfer rate for console redirection. – Options available: 9600, 19200, 57600, 115200. Default setting is 115200.

(Note) Advanced items prompt when this item is defined.

Parameter	Description
Serial Port for Out-of-Band EMS Console Redirection Settings(continued)	<ul style="list-style-type: none">◆ Flow Control<ul style="list-style-type: none">– Flow control can prevent data loss from buffer overflow. When sending data, if the receiving buffers are full, a 'stop' signal can be sent to stop the data flow. Once the buffers are empty, a 'start' signal can be sent to re-start the flow. Hardware flow control uses two wires to send start/stop signals.– Options available: None, Hardware RTS/CTS, Software Xon/Xoff. Default setting is None.

2-2-7 CPU Configuration

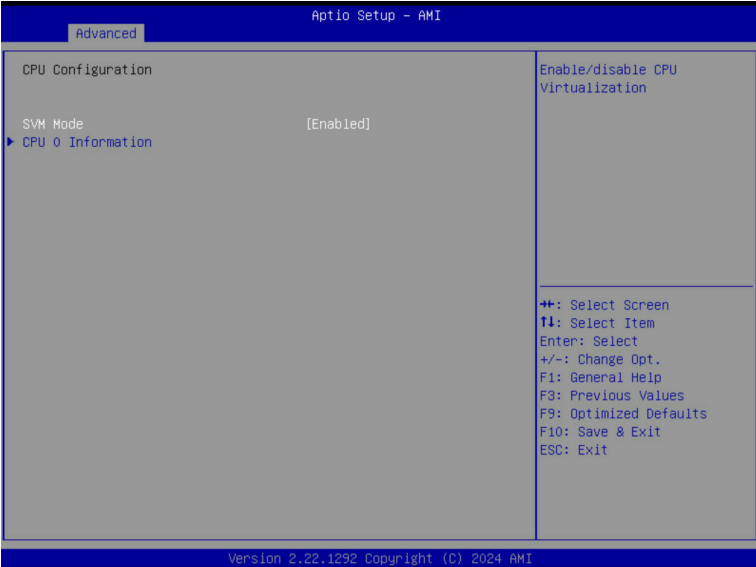

Parameter	Description
SVM Mode	Enable/Disable the CPU Virtualization. Options available: Disabled, Enabled. Default setting is Enabled .
CPU 0 Information	Press [Enter] to view the memory information related to CPU 0.

2-2-8 PCI Subsystem Settings

Aptio Setup - AMI

Advanced

PCI Bus Driver Version	A5.01.28	Change PCIe_3 PCIe lanes.
PCI_E_3	[Auto]	
PCI_E_3 I/O ROM	[Enabled]	
PCI_E_3 Link Speed	[Auto]	
U2_P0_60	[x4 x4 x4 x4]	
U2_P0_60 I/O ROM	[Enabled]	
U2_P0_60 Link Speed	[Auto]	
PCI_E_4	[Auto]	
PCI_E_4 I/O ROM	[Enabled]	
PCI_E_4 Link Speed	[Auto]	
U2_P0_61	[x4 x4]	
U2_P0_61 I/O ROM	[Enabled]	
U2_P0_61 Link Speed	[Auto]	
PCI_E_6	[Auto]	
PCI_E_6 I/O ROM	[Enabled]	
PCI_E_6 Link Speed	[Auto]	
U2_P0_62	[x4 x4]	
U2_P0_62 I/O ROM	[Enabled]	

▲
 ++: Select Screen
 T1: Select Item
 Enter: Select
 +/-: Change Opt.
 F1: General Help
 F3: Previous Values
 F9: Optimized Defaults
 F10: Save & Exit
 ESC: Exit
 ▼

Version 2.22.1292 Copyright (C) 2024 AMI

Aptio Setup - AMI

Advanced

U2_P0_62	[x4 x4]	Enables or Disables PCI Express Device Relaxed Ordering.
U2_P0_62 I/O ROM	[Enabled]	
U2_P0_62 Link Speed	[Auto]	
PCI_E_7	[Auto]	
PCI_E_7 I/O ROM	[Enabled]	
PCI_E_7 Link Speed	[Auto]	
U2_P0_63A	[SATA]	
U2_P0_63A I/O ROM	[Enabled]	
U2_P0_63A Link Speed	[Auto]	
U2_P0_63B	[SATA]	
U2_P0_63B I/O ROM	[Enabled]	
U2_P0_63B Link Speed	[Auto]	
Onboard LAN Controller	[Enabled]	
Onboard LAN1 I/O ROM	[Enabled]	
Onboard LAN2 I/O ROM	[Enabled]	
PCI Devices Common Settings:		
Above 4G Decoding	[Enabled]	
Re-Size BAR Support	[Disabled]	
SR-IOV Support	[Enabled]	
Relaxed Ordering	[Enabled]	

▲
 ++: Select Screen
 T1: Select Item
 Enter: Select
 +/-: Change Opt.
 F1: General Help
 F3: Previous Values
 F9: Optimized Defaults
 F10: Save & Exit
 ESC: Exit
 ▼

Version 2.22.1292 Copyright (C) 2024 AMI

Parameter	Description
PCI Bus Driver Version	Displays the PCI Bus Driver version information.
PCI_E_# ^(Note1)	Change the PCIe lanes. Options available: Disabled, Auto, x16, x8x8, x8x4x4, x4x4x8, x4x4x4x4. Default setting is Auto .
SLOT #_I/O ROM ^(Note1)	When enabled, this setting will initialize the device expansion ROM for the related PCI-E slot. Options available: Disabled, Enabled. Default setting is Enabled .
SLOT #_Link Speed ^(Note1)	Configure PCIe max link speed. Options available: Auto, Gen4, Gen3, Gen2, Gen1. Default setting is Auto .
U2_P0_G0/1/2 Lanes ^(Note2)	Change MCIO PCIe lanes. Options available: Disabled, Auto, x8, x16, x4x4, x8x8, x8x4x4, x4x4x8, x4x4x4x4. Default setting is Auto .
U2_P0_G3 Lanes	Change MCIO U2_P0_G3 PCIe lanes. Options available: Disabled, SATA, x16, x8x8, x8x4x4, x4x4x8, x4x4x4x4. Default setting is SATA .
U2_P0_G0/1/2/3 I/O ROM ^(Note2)	When enabled, this setting will initialize the device expansion ROM for the related devices. Options available: Disabled, Enabled. Default setting is Enabled .
U2_P0_G0/1/2/3 Link Speed ^(Note2)	Configure MCIO PCIe max link speed. Options available: Auto, Gen4, Gen3, Gen2, Gen1. Default setting is Auto .
Onboard LAN Controller ^(Note3)	Enable/Disable the onboard LAN devices. Options available: Disabled, Enabled. Default setting is Enabled .
Onboard LAN# I/O ROM ^(Note3)	Enable/Disable the onboard LAN devices, and initializes device expansion ROM. Options available: Disabled, Enabled. Default setting is Enabled .
PCI Devices Common Settings	
Above 4G Decoding	Enable/Disable memory mapped I/O to 4GB or greater address space (Above 4G Decoding). Options available: Disabled, Enabled. Default setting is Enabled .
SR-IOV Support	If the system has SR-IOV capable PCIe devices, this item Enable/Disable Single Root IO Virtualization Support. Options available: Disabled, Enabled. Default setting is Enabled .
Relaxed Ordering	Enable/Disable PCI express device relaxed ordering. Options available: Disabled, Enabled. Default setting is Enabled .

(Note1) This section is dependent on the available PCIe Slot.

(Note2) This section is dependent on the available MCIO connector.

(Note3) This section is dependent on the available LAN controller.

2-2-9 USB Configuration

Aptio Setup - AMI

Advanced

<p>USB Configuration</p> <p>USB Module Version 29</p> <p>USB Controllers: 2 XHCIs</p> <p>USB Devices: 8 Drives, 2 Keyboards, 1 Mouse, 5 Hubs</p> <p>Legacy USB Support [Enabled] XHCI Hand-off [Enabled] USB Mass Storage Driver Support [Enabled]</p> <p>USB hardware delays and time-outs: USB transfer time-out [20 sec] Device reset time-out [20 sec] Device power-up delay [Auto]</p> <p>Mass Storage Devices: AMI Virtual CDROM0 1.00 [Auto] AMI Virtual HDisk0 1.00 [Auto] AMI Virtual CDROM1 1.00 [Auto] AMI Virtual CDROM2 1.00 [Auto] AMI Virtual CDROM3 1.00 [Auto] AMI Virtual HDisk1 1.00 [Auto]</p>	<p>Enables Legacy USB support. AUTO option disables legacy support if no USB devices are connected. DISABLE option will keep USB devices available only for EFI applications.</p> <hr/> <p>++: Select Screen T1: Select Item Enter: Select +/-: Change Opt. F1: General Help F3: Previous Values F9: Optimized Defaults F10: Save & Exit ESC: Exit</p>
---	--

Version 2.22.1292 Copyright (C) 2024 AMI

Aptio Setup - AMI

Advanced

<p>USB Controllers: 2 XHCIs</p> <p>USB Devices: 8 Drives, 2 Keyboards, 1 Mouse, 5 Hubs</p> <p>Legacy USB Support [Enabled] XHCI Hand-off [Enabled] USB Mass Storage Driver Support [Enabled]</p> <p>USB hardware delays and time-outs: USB transfer time-out [20 sec] Device reset time-out [20 sec] Device power-up delay [Auto]</p> <p>Mass Storage Devices: AMI Virtual CDROM0 1.00 [Auto] AMI Virtual HDisk0 1.00 [Auto] AMI Virtual CDROM1 1.00 [Auto] AMI Virtual CDROM2 1.00 [Auto] AMI Virtual CDROM3 1.00 [Auto] AMI Virtual HDisk1 1.00 [Auto] AMI Virtual HDisk2 1.00 [Auto] AMI Virtual HDisk3 1.00 [Auto]</p>	<p>Mass storage device emulation type. 'AUTO' enumerates devices according to their media format. Optical drives are emulated as 'CDROM', drives with no media will be emulated according to a drive type.</p> <hr/> <p>++: Select Screen T1: Select Item Enter: Select +/-: Change Opt. F1: General Help F3: Previous Values F9: Optimized Defaults F10: Save & Exit ESC: Exit</p>
--	---

Version 2.22.1292 Copyright (C) 2024 AMI

Parameter	Description
USB Configuration	
USB Module Version	Displays the USB module version information.
USB Controllers	Displays the supported USB controllers.
USB Devices:	Displays the USB devices connected to the system.
Legacy USB Support	Enable/Disable the Legacy USB support function. AUTO option disables legacy support if no USB devices are connected. DISABLE option will keep USB devices available only for EFI applications. Options available: Enabled, Disabled, Auto. Default setting is Enabled .
XHCI Hand-off	Enable/Disable the XHCI Hand-off support. Options available: Enabled, Disabled. Default setting is Enabled .
USB Mass Storage Driver Support ^(Note)	Enable/Disable the USB Mass Storage Driver Support. Options available: Disabled, Enabled. Default setting is Enabled .
USB hardware delays and time-outs	
USB transfer time-out	Selects the time-out value for USB Control/Bulk/Interrupt transfers. Options available: 1 sec, 5 sec, 10 sec, 20 sec. Default setting is 20 sec .
Device reset time-out	Selects the time-out value during a USB mass storage device reset. Options available: 10 sec, 20 sec, 30 sec, 40 sec. Default setting is 20 sec .
Device power-up delay	Maximum time the device will take before it properly reports itself to the Host Controller. "Auto" uses default value: for a Root port it is 100 ms, for a Hub port the delay is taken from Hub descriptor. Options available: Auto, Manual. Default setting is Auto .

(Note) This item is present only if you attach USB devices.

2-2-10 Network Stack Configuration

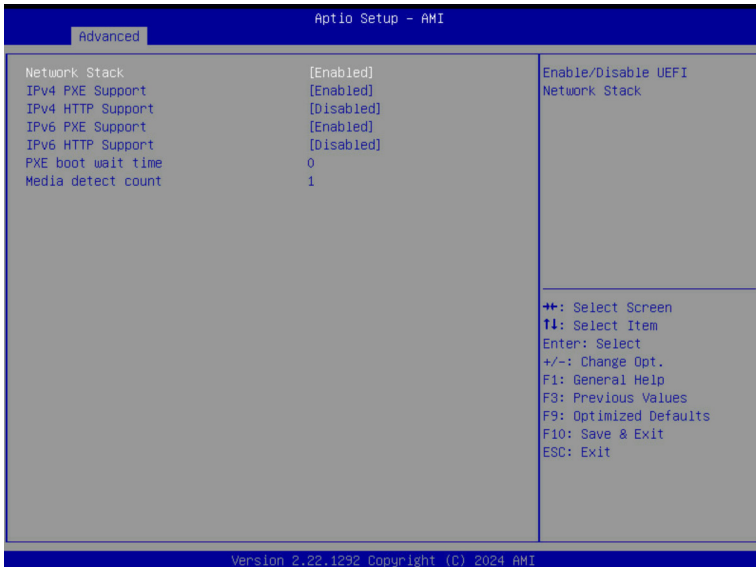

Parameter	Description
Network Stack	Enable/Disable the UEFI network stack. Options available: Enabled, Disabled. Default setting is Enabled .
Ipv4 PXE Support ^(Note)	Enable/Disable the Ipv4 PXE feature. Options available: Enabled, Disabled. Default setting is Enabled .
Ipv4 HTTP Support ^(Note)	Enable/Disable the Ipv4 HTTP feature. Options available: Enabled, Disabled. Default setting is Disabled .
Ipv6 PXE Support ^(Note)	Enable/Disable the Ipv6 PXE feature. Options available: Enabled, Disabled. Default setting is Enabled .
Ipv6 HTTP Support ^(Note)	Enable/Disable the Ipv6 HTTP feature. Options available: Enabled, Disabled. Default setting is Disabled .
PXE boot wait time ^(Note)	Wait time in seconds to press ESC key to abort the PXE boot. Press the <+> / <-> keys to increase or decrease the desired values.
Media detect count ^(Note)	Number of times the presence of media will be checked. Press the <+> / <-> keys to increase or decrease the desired values.

(Note) This item appears when **Network Stack** is set to **Enabled**.

2-2-11 Post Report Configuration

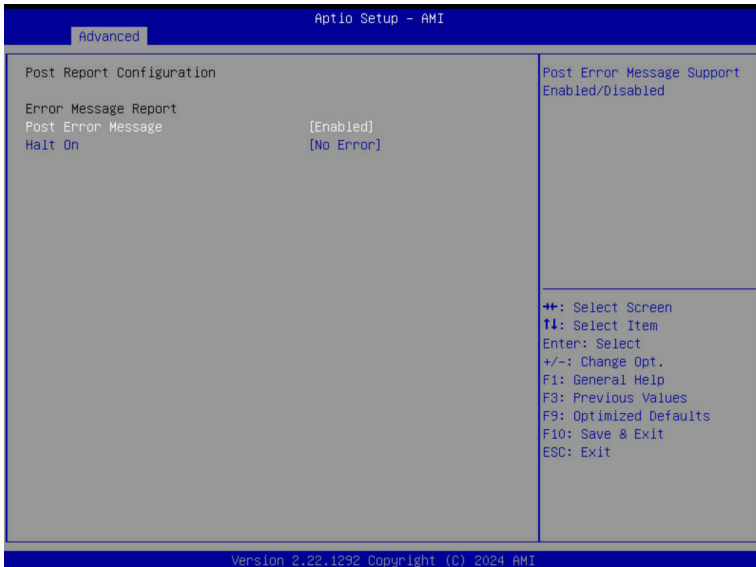

Parameter	Description
Post Report Configuration	
Error Message Report	
Post Error Message	Enable/Disable the POST Error Message support. Options available: Enabled, Disabled. Default setting is Enabled .
Halt On	Options available: No Error, All Error. Default setting is No Error .

2-2-12 NVMe Configuration

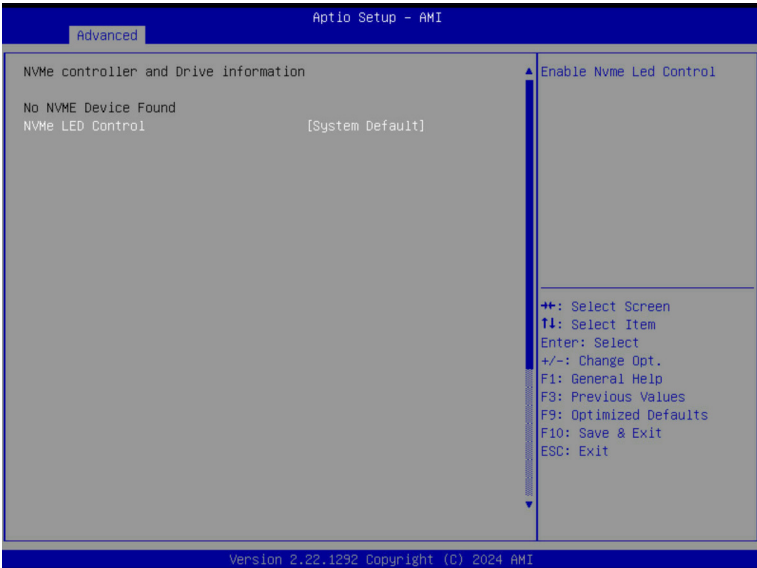

Parameter	Description
NVMe Configuration	Displays the NVMe devices connected to the system.
NVMe LED Control	Enable/Disable NVMe LED Control. Options available: System Default, Disabled, Enabled. Default setting is System Default .

2-2-13 SATA Configuration

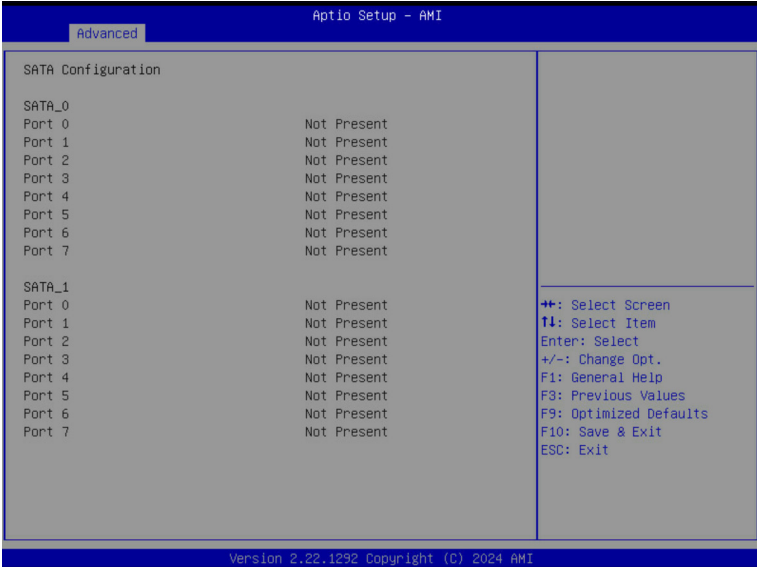

Parameter	Description
SATA Configuration	Displays the installed HDD devices information. System will automatically detect HDD type.

2-2-14 Graphic Output Configuration



Parameter	Description
Output Device Type	Selects output device type. Options available: First loaded Device, Onboard Device, External Device, Specific Device. Default setting is Onboard Device .

2-2-15 AMD Mem Configuration Status

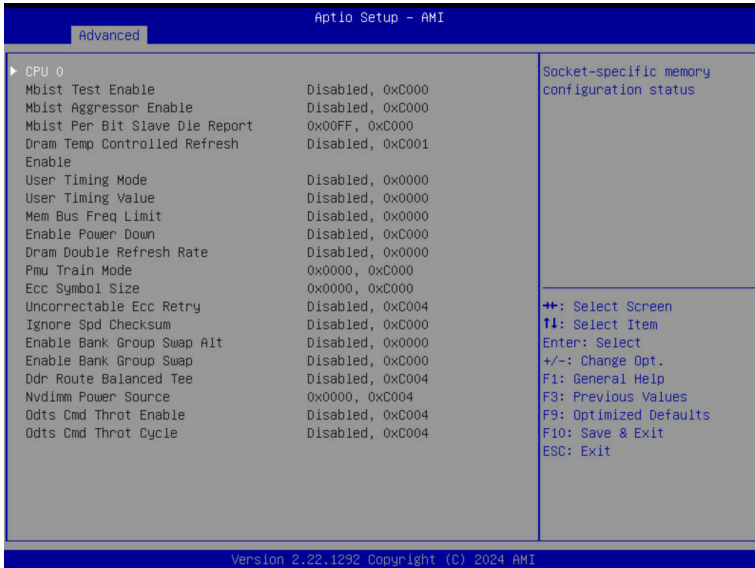

Parameter	Description
CPU 0	Press [Enter] to view the memory configuration status related to CPU 0.

2-2-16 Tls Auth Configuration



Parameter	Description
Server CA Configuration	<p>Press [Enter] for configuration of advanced items.</p> <ul style="list-style-type: none"> ◆ Enroll Cert <ul style="list-style-type: none"> – Press [Enter] to enroll a certificate <ul style="list-style-type: none"> • Enroll Cert Using File • Cert GUID <p>Input digit character in 1111111-2222-3333-4444-1234567890ab format.</p> <ul style="list-style-type: none"> – Commit Changes and Exit – Discard Changes and Exit <ul style="list-style-type: none"> ◆ Delete Cert
Client Cert Configuration	Press [Enter] for configuration of advanced items.

2-2-17 RAM Disk Configuration

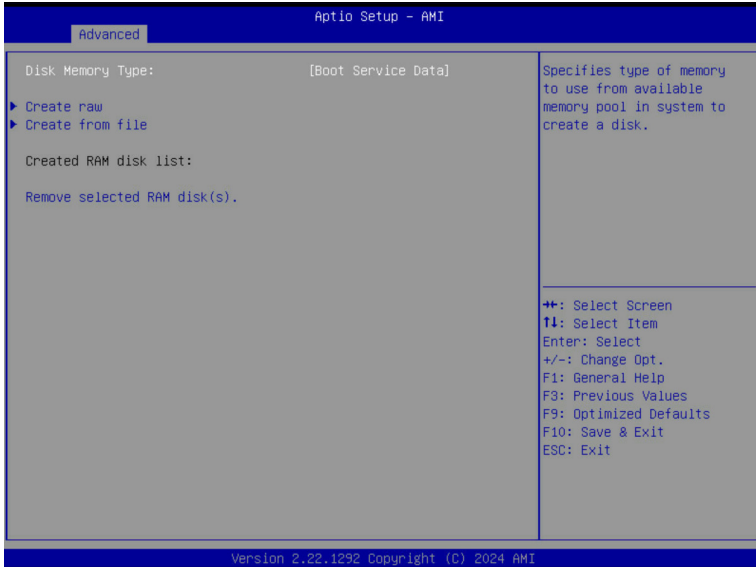

Parameter	Description
Disk Memory Type	Specifies the type of memory to use from available memory pool in system to create a disk. Options available: Boot Service Data, Reserved. Default setting is Boot Service Data .
Create Raw	Creates a raw RAM disk. <ul style="list-style-type: none"> ◆ Size (Hex) <ul style="list-style-type: none"> – Input a valid RAM disk size that should be multiple of the RAM disk block size. ◆ Create & Exit ◆ Discard & Exit
Create from file	Creates a RAM disk from a given file.
Created RAM disk list	
Remove selected RAM disk(s)	Selects the RAM disk(s) to remove.

2-2-18 iSCSI Configuration



Parameter	Description
iSCSI Initiator Name	Press [Enter] and name iSCSI Initiator. Only IQN format is accepted. Range: from 4 to 223
Add an Attempt	Press [Enter] to configure advanced items.
Delete Attempts	Press [Enter] to configure advanced items.
Change Attempt Order	Press [Enter] to configure advanced items.

2-2-19 Broadcom BCM57416 10GBASE-T Network Connection



Parameter	Description
Firmware Image Menu	Press [Enter] to view firmware image information.
Device Configuration Menu	<p>Press [Enter] to configure advanced items.</p> <ul style="list-style-type: none"> ◆ Multi-Function Mode <ul style="list-style-type: none"> – Configures the NIC Hardware Mode. – Options available: SF, NPAR 1.0. Default setting is SF. ◆ SR-IOV <ul style="list-style-type: none"> – Enable/Disable Single Root I/O Virtualization. – Options available: Disabled, Enabled. Default setting is Disabled. ◆ Number of MSI-X Vectors per VF <ul style="list-style-type: none"> – Configures the number of MSI-X Vectors per VF (0-128). – Default setting is 16.
Device Configuration Menu	<ul style="list-style-type: none"> ◆ Maximum Number of PF MSI-X Vectors <ul style="list-style-type: none"> – Configures the maximum number of PF MSI-X Vectors (0-512 per controller). – Default setting is 74. ◆ Energy Efficient Ethernet <ul style="list-style-type: none"> – Enable/Disable Energy Efficient Ethernet operation. – Options available: Disabled, Enabled. Default setting is Disabled. ◆ Operational Link Speed <ul style="list-style-type: none"> – Configures the link speed setting to be used as the default link speed for the selected port. – Options available: AutoNeg. Default setting is AutoNeg.

Parameter	Description
Device Configuration Menu (continued)	<ul style="list-style-type: none"> ◆ Support RDMA <ul style="list-style-type: none"> – Enable/Disable RDMA support for this port. – Options available: Disabled, Enabled. Default setting is Disabled. ◆ DCB Protocol <ul style="list-style-type: none"> – Enable/Disable DCB protocol. – Options available: Disabled, Enabled (IEEE only), CEE (only), Both (IEEE preferred with fallback to CEE). Default setting is Disabled. ◆ LLDP nearest bridge <ul style="list-style-type: none"> – Enable/Disable LLDP nearest bridge state. – Options available: Disabled, Enabled. Default setting is Enabled. ◆ Default EVB Mode <ul style="list-style-type: none"> – Configures the default Edge Virtual Bridging mode. – Options available: VEB, VEPA, None. Default setting is VEB. ◆ Enable PME Capability <ul style="list-style-type: none"> – Enable/Disable PME Capability support. – Options available: Disabled, Enabled. Default setting is Enabled. ◆ Flow Offload <ul style="list-style-type: none"> – Options available: Enabled, Disabled. Default setting is Disabled. ◆ Live Firmware Upgrade <ul style="list-style-type: none"> – Options available: Enabled, Disabled. Default setting is Disabled. ◆ Adapter Error Recovery <ul style="list-style-type: none"> – Options available: Enabled, Disabled. Default setting is Disabled.
MBA Configuration Menu	<p>Press [Enter] to configure advanced items.</p> <ul style="list-style-type: none"> ◆ Option ROM <ul style="list-style-type: none"> – Enable/Disable Boot Option ROM. – Options available: Disabled, Enabled. Default setting is Enabled. ◆ Legacy Boot Protocol <ul style="list-style-type: none"> – Selects non-UEFI Boot Protocol: Preboot Execution Environment (PXE)/iSCSI. – Options available: PXE, iSCSI, NONE. Default setting is PXE. ◆ Boot Strap Type <ul style="list-style-type: none"> – Selects the boot strap type. Options available: Auto Detect, BBS, Int 18h, Int 19h. Default setting is Auto Detect. ◆ Hide Setup Prompt <ul style="list-style-type: none"> – Configures whether the Setup Prompt is displayed during ROM initialization. – Options available: Disabled, Enabled. Default setting is Disabled. ◆ Setup Key Stroke <ul style="list-style-type: none"> – Configures key strokes to invoke the configuration menu. – Options available: Ctrl-S, Ctrl-B. Default setting is Ctrl-S. ◆ Banner Message Timeout <ul style="list-style-type: none"> – Selects the timeout value. (0 defaults to 4 seconds, 15 is no delay, 1-14 is timeout value in seconds) – Default setting is 5.

Parameter	Description
MBA Configuration Menu (continued)	<ul style="list-style-type: none"> ◆ Pre-boot Wake On LAN <ul style="list-style-type: none"> – Configures Pre-boot Wake on LAN (WOL). – Options available: Disabled, Enabled. Default setting is Enabled. ◆ VLAN Mode <ul style="list-style-type: none"> – Configures the virtual LAN (VLAN) mode. – Options available: Disabled, Enabled. Default setting is Disabled. ◆ VLAN ID <ul style="list-style-type: none"> – Configures the VLAN ID (1...4094). – This item is available only when VLAN Mode is Enabled. ◆ Boot Retry Count <ul style="list-style-type: none"> – Selects the number of boot retries. – Options available: No Retry, 1 Retry, 2 Retries, 3 Retries, 4 Retries, 5 Retries, 6 Retries, Indefinite Retries. Default setting is No Retry.
iSCSI Boot Configuration Menu	Press [Enter] to configure advanced items.
Blink LEDs	Identifies the physical network port by blinking the associated LED. Press the numeric keys to adjust desired values.
Link Status	Specifies the link status of the port.
Physical Link Speed	Displays the technical specifications for the Network Interface Controller.
Chip Type	Displays the technical specifications for the Network Interface Controller.
PCI Device ID	Displays the technical specifications for the Network Interface Controller.
Bus:Device:Function	Displays the technical specifications for the Network Interface Controller.
Permanent MAC Address	Displays the MAC address of the Ethernet controller.
Virtual MAC Address	Displays the virtual MAC address of the Ethernet controller.
Restore Defaults	Resets the adapter to factory defaults.

2-2-19-1 Firmware Image Menu

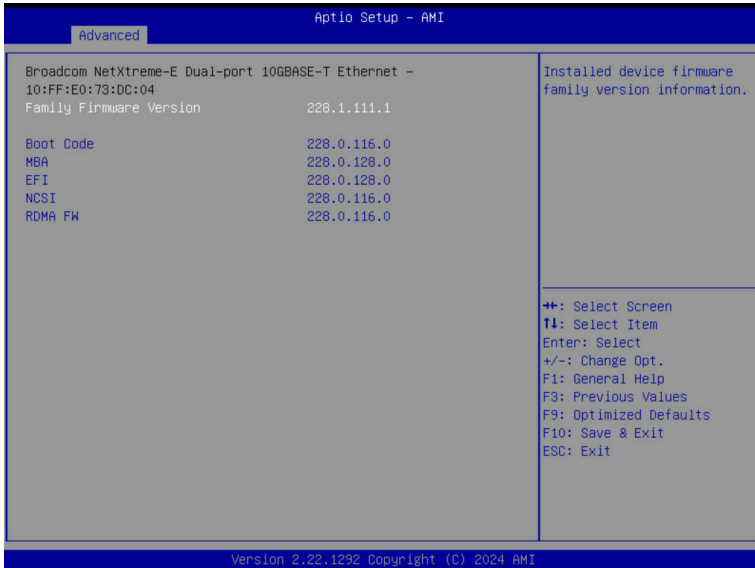

Parameter	Description
iSCSI General Parameters	Press [Enter] to configure advanced items.
	<ul style="list-style-type: none"> ◆ TCP/IP Parameters via DHCP <ul style="list-style-type: none"> – Acquires TCP/IP Parameters via DHCP. – Options available: Disabled, Enabled. Default setting is Enabled.
	<ul style="list-style-type: none"> ◆ IP Autoconfiguration <ul style="list-style-type: none"> – Auto-configures the IP configuration.
	<ul style="list-style-type: none"> ◆ iSCSI Parameters via DHCP <ul style="list-style-type: none"> – Acquires iSCSI Parameters via DHCP. – Options available: Disabled, Enabled. Default setting is Disabled.
	<ul style="list-style-type: none"> ◆ CHAP Authentication <ul style="list-style-type: none"> – Enable/Disable the CHAP authentication. – Options available: Disabled, Enabled. Default setting is Disabled.
	<ul style="list-style-type: none"> ◆ Boot to iSCSI Target <ul style="list-style-type: none"> – Enable/Disable booting to iSCSI target after log-on. – Options available: Disabled, Enabled, One Time Disabled. Default setting is Enabled.
	<ul style="list-style-type: none"> ◆ DHCP Vendor ID <ul style="list-style-type: none"> – Configures the DHCP vendor ID (up to 32 characters long).
	<ul style="list-style-type: none"> ◆ Link Up Delay Time <ul style="list-style-type: none"> – Configures the link up delay time in seconds (0-225).

Parameter	Description
iSCSI General Parameters (continued)	<ul style="list-style-type: none"> ◆ Use TCP Timestamp <ul style="list-style-type: none"> – Enable/Disable the TCP timestamp. – Options available: Disabled, Enabled. Default setting is Disabled. ◆ Target as First HDD <ul style="list-style-type: none"> – Enable/Disable target appears as first hard disk drive (HDD) in the system. – Options available: Disabled, Enabled. Default setting is Disabled. ◆ LUN Busy Retry Count <ul style="list-style-type: none"> – Configures the number of retries in 2 second intervals when LUN is busy (0-60). – Default setting is 0. ◆ IP Version <ul style="list-style-type: none"> – Displays the IP version supported. Modifying this parameter will reset all IP-related fields. – Options available: IPv4, IPv6. Disabled. Default setting is IPv4.
iSCSI Initiator Parameters	<p data-bbox="352 592 689 616">Press [Enter] to configure advanced items.</p> <ul style="list-style-type: none"> ◆ IP Address <ul style="list-style-type: none"> – Configures the initiator IP address. ◆ Subnet Mask <ul style="list-style-type: none"> – Configures the IP subnet mask. ◆ Default Gateway <ul style="list-style-type: none"> – Configures the default gateway IP address. ◆ Primary DNS <ul style="list-style-type: none"> – Configures the primary DNS IP address. ◆ Secondary DNS <ul style="list-style-type: none"> – Configures the secondary DNS IP address. ◆ iSCSI Name <ul style="list-style-type: none"> – Configures the iSCSI name. ◆ CHAP ID <ul style="list-style-type: none"> – Configures the Challenge-Handshake Authentication Protocol (CHAP) ID (up to 128 characters in length). ◆ CHAP Secret <ul style="list-style-type: none"> – Configure the Challenge-Handshake Authentication Protocol (CHAP) Secret (12 to 16 characters in length).
iSCSI First/Second Target Parameters	<p data-bbox="352 1150 689 1174">Press [Enter] to configure advanced items.</p> <ul style="list-style-type: none"> ◆ Connect <ul style="list-style-type: none"> – Enable/Disable the target establishment. – Options available: Disabled, Enabled. Default setting is Disabled. ◆ IP Address <ul style="list-style-type: none"> – Configures the Target IP address. ◆ TCP Port <ul style="list-style-type: none"> – Configures the Target TCP port number (1-65535).

Parameter	Description
iSCSI First/Second Target Parameters (continued)	<ul style="list-style-type: none"> ◆ Boot LUN <ul style="list-style-type: none"> – Configures the Target boot LUN number (0-255). ◆ iSCSI Name <ul style="list-style-type: none"> – Configures the iSCSI name. ◆ CHAP ID <ul style="list-style-type: none"> – Configures the Challenge-Handshake Authentication Protocol (CHAP) ID (up to 128 characters in length). ◆ CHAP Secret <ul style="list-style-type: none"> – Configure the Challenge-Handshake Authentication Protocol (CHAP) Secret (12 to 16 characters in length).
Secondary Device	<p>Press [Enter] to configure advanced items.</p> <ul style="list-style-type: none"> ◆ Secondary Device <ul style="list-style-type: none"> – Inputs the secondary device MAC address. ◆ Use Independent Target Portal <ul style="list-style-type: none"> – Use Independent target portal when multipath I/O is enabled. – Options available: Disabled, Enabled. Default setting is Disabled. ◆ Use Independent Target Name <ul style="list-style-type: none"> – Use Independent target name when multipath I/O is enabled. – Options available: Disabled, Enabled. Default setting is Disabled.

2-2-20 VLAN Configuration



Parameter	Description
Enter Configuration Menu	<p>Press [Enter] to configure advanced items.</p> <ul style="list-style-type: none"> ◆ Create new VLAN ◆ VLAN ID <ul style="list-style-type: none"> – Sets VLAN ID for a new VLAN or an existing VLAN. – Press the <+> / <-> keys to increase or decrease the desired values. – The valid range is from 0 to 4094. ◆ Priority <ul style="list-style-type: none"> – Sets 802.1Q Priority for a new VLAN or an existing VLAN. – Press the <+> / <-> keys to increase or decrease the desired values. – The valid range is from 0 to 7. ◆ Add VLAN <ul style="list-style-type: none"> – Press [Enter] to create a new VLAN or update an existing VLAN. ◆ Configured VLAN List ◆ Remove VLAN <ul style="list-style-type: none"> – Press [Enter] to remove an existing VLAN.

2-2-21 MAC IPv4 Network Configuration



Parameter	Description
Configured	Indicates whether network address is configured successfully or not. Options available: Enabled, Disabled. Default setting is Disabled .
Enable DHCP ^(Note)	Options available: Enabled, Disabled. Default setting is Disabled .
Local IP Address ^(Note)	Press [Enter] to configure local IP address.
Local NetMask ^(Note)	Press [Enter] to configure local NetMask.
Local Gateway ^(Note)	Press [Enter] to configure local Gateway
Local DNS Servers ^(Note)	Press [Enter] to configure local DNS servers
Save Changes and Exit	Press [Enter] to save all configurations.

(Note) This item appears when **Configured** is set to **Enabled**.

2-2-22 MAC IPv6 Network Configuration



Parameter	Description
Enter Configuration Menu	<p>Press [Enter] to configure advanced items.</p> <ul style="list-style-type: none"> ◆ Displays the MAC Address information. ◆ Interface ID <ul style="list-style-type: none"> – The 64 bit alternative interface ID for the device. The string is colon separated. e.g. ff:dd:88:66:cc:1:2:3. ◆ DAD Transmit Count <ul style="list-style-type: none"> – The number of consecutive Neighbor solicitation messages sent while performing Duplicate Address Detection on a tentative address. A value of zero indicates that Duplicate Address Detection is not performed. ◆ Policy <ul style="list-style-type: none"> – Options available: automatic, manual. Default setting is automatic. ◆ Save Changes and Exit <ul style="list-style-type: none"> – Press [Enter] to save all configurations.

2-3 AMD CBS Menu

AMD CBS menu displays submenu options for configuring the CPU-related information that the BIOS automatically sets. Select a submenu item, then press [Enter] to access the related submenu screen.

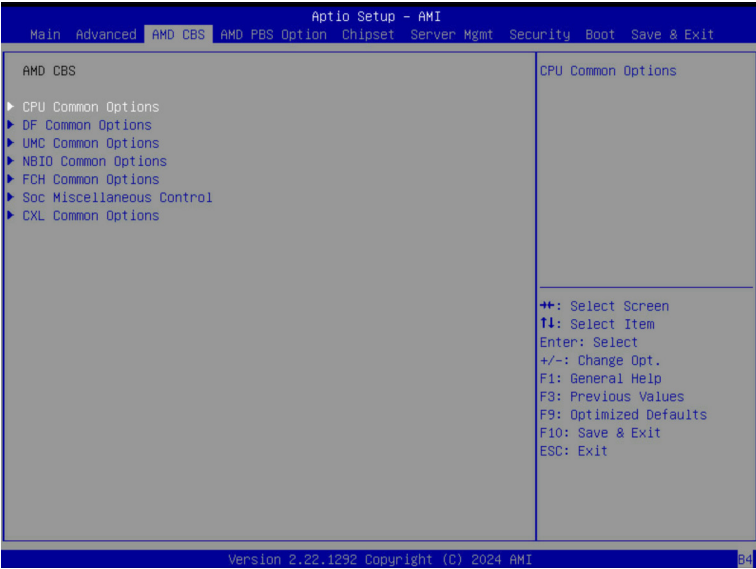

2-3-1 CPU Common Options

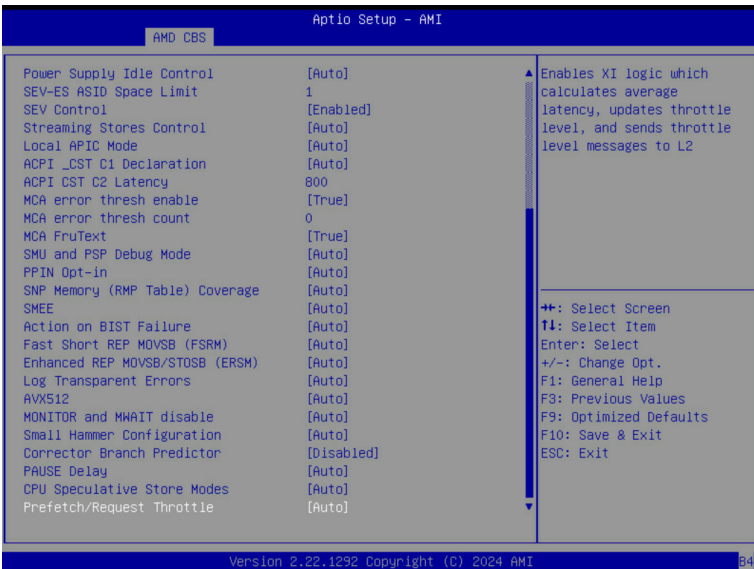
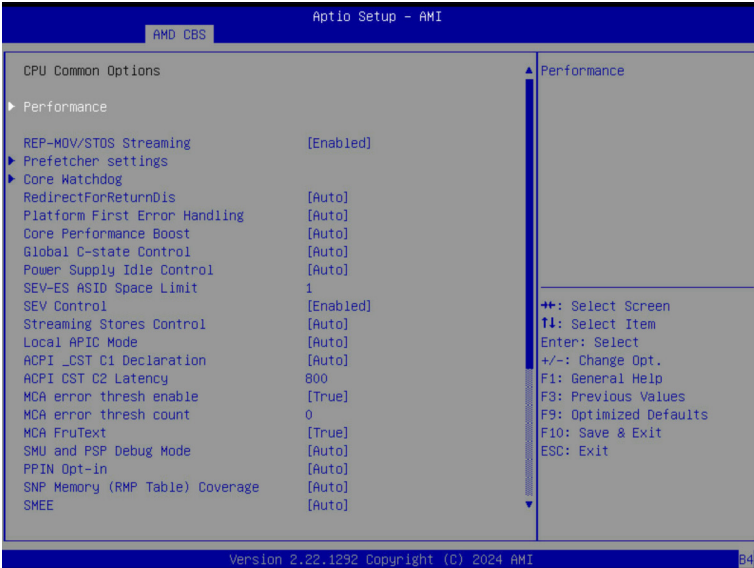

Parameter	Description
CPU Common Options	
Performance	Press [Enter] for configuration of advanced items.
REP-MOV/STOS Streaming	Allow REP-MOV/STOS to use non-caching streaming stores for large sizes. Options available: Disabled, Enabled. Default setting is Enabled .
Prefetcher settings	Press [Enter] for configuration of advanced items.
Core Watchdog	Press [Enter] for configuration of advanced items.
RedirectForReturnDis	From a workaround for GCC/C000005 issue for XV Core on CZ A0, setting MSRC001_1029 Decode Configuration (DE_CFG) bit 14 [DecfgNoRdrctForReturns] to 1. Options available: Auto, 1, 0. Default setting is Auto .
Platform First Error Handling	Enable/Disable PFEH, cloak individual banks, and mask deferred error interrupts from each bank. Options available: Enabled, Disabled, Auto. Default setting is Auto .
Core Performance Boost	Enable/Disable the Core Performance Boost function. Options available: Disabled, Auto. Default setting is Auto .
Global C-state Control	Controls the IO based C-state generation and DF C-states. Options available: Disabled, Enabled, Auto. Default setting is Auto .
Power Supply Idle Control	Configures the Power Supply Idle Control. Options available: Low Current Idle, Typical Current Idle, Auto. Default setting is Auto .
SEV-ES ASID Space Limit	Configures the Space limit for SEV-ES ASIDs. Default setting is 1 .
SEV Control	Enable/Disable SEV control. Options available: Enable, Disable. Default setting is Enable .
Streaming Stores Control	Enable/Disable the Streaming Stores functionality. Options available: Disabled, Enabled, Auto. Default setting is Auto .
Local APIC Mode	Sets the Local APIC Mode. Options available: Compatibility, xAPIC, x2APIC, Auto. Default setting is Auto .
ACPI_CST C1 Declaration	Determines whether or not to declare the C1 state to the OS.. Options available: Disabled, Enabled, Auto. Default setting is Auto .
MCA error thresh enable	Enable MCA error thresholding. Options available: False, True, Auto. Default setting is True .
MCA FruText	Enable MCA FruText. Options available: False, True. Default setting is Auto .
SMU and PSP Debug Mode	When this option is enabled, specific uncorrected errors detected by the PSP FW or SMU FW will hand and not reset the system. Options available: Disabled, Enabled, Auto. Default setting is Auto .
PPIN Opt-in	Enable/Disable the PPIN feature. Options available: Disabled, Enabled, Auto. Default setting is Auto .
SNP Memory (RMP Table) Coverage	Enabled: Enter system memory is covered. Options available: Disabled, Enabled, Custom, Auto. Default setting is Auto .

Parameter	Description
SMEE	Controls the Secure Memory Encryption Enable (SMEE) function. Options available: Disable, Enable, Auto. Default setting is Auto .
Action on BIST Failure	Action to take when a CCD BIST failure is detected. Options available: Do nothing, Down-CCD, Auto. Default setting is Auto .
Enhanced REP MOVSB/ STOSB (ERMSB)	Options available: Disabled, Enabled, Auto. Default setting is Auto .
Log Transparent Errors	Enable/Disable the log Transparent errors function. Options available: Auto, Disabled, Enabled. Default setting is Auto .
AVX512	Enable/Disable AVX512. Options available: Disabled, Enabled, Auto. Default setting is Auto .
MONITOR and MWAIT disable	The MONITOR, MWAIT, MONITORX and MWAITX opcodes become invalid when enabled. Options available: Enabled, Disabled, Auto. Default setting is Auto
Small Hammer Configuration	Options available: Disabled, Enabled, Auto. Default setting is Auto .
Corrector Branch Predictor	Options available: Disable, Enable. Default setting is Disable .
PAUSE Delay	Number a cycles thread will be idle after a PAUSE instruction. Options available: Auto, Disable, 16 cycles, 32 cycles, 64 cycles, 128 cycles. Default setting is Auto .
CPU Speculative Store Modes	Select the CPU speculative store modes. Options available: Balanced, More Speculative, Less Speculative, Auto. Default setting is Auto .

2-3-1-1 Performance



Parameter	Description
Performance	
OC Mode ^(Notes)	Options available: Normal Operation, Customized. Default setting is Normal Operation .
Custom Core Pstates	Allows you to accept or decline enabling Custom Core Pstates. When accepted, you can disable or customize core pstates.
CCD/Core/Thread Enablement	Allows you to accept or decline enabling CCDs, processor cores and threads. When accepted, you can control the number of CCDs to be used, and the number of cores to be used. <ul style="list-style-type: none"> ◆ CCD Control <ul style="list-style-type: none"> – Options available: Auto, 2 CCDs, 4 CCDs, 6 CCDs, 8 CCDs, 10 CCDs. Default setting is Auto. ◆ Core Control <ul style="list-style-type: none"> – Options available: Auto, ONE(1+0), TWO(2+0), THREE(3+0), FOUR(4+0), FIVE(5+0), SIX(6+0), SEVEN(7+0). – Default setting is Auto.
SMT Control	Can be used to disable symmetric multithreading. To re-enable SMT, a POWER CYCLE is needed after select the 'Enable' option. Select 'Auto' base on BIOS PCD. (PcdAmdSmtMode) default setting. Options available: Disable, Enable, Auto. Default setting is Enable .

(Note) Advanced items are configurable when this item is defined.

2-3-1-2 Prefetcher Settings

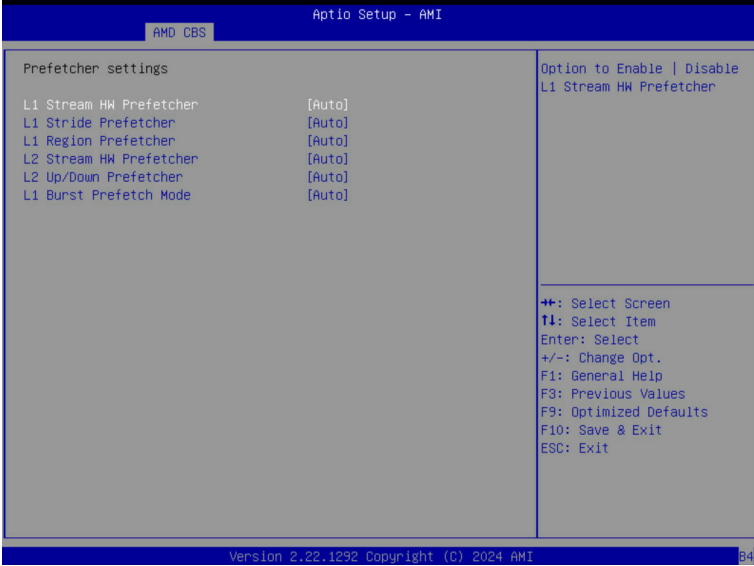

Parameter	Description
Prefetcher settings	
L1 Stream HW Prefetcher	Enable/Disable L1 Stream HW Prefetcher. Options available: Disable, Enable, Auto. Default setting is Auto .
L1 Stride Prefetcher	Use memory access history of individual instructions to fetch additional lines when each access is a constant distance from the previous. Enable/Disable L1 Stride Prefetcher. Options available: Disable, Enable, Auto. Default setting is Auto .
L1 Region Prefetcher	Use memory access history to fetch additional lines when the data access for a given instruction tends to be followed by other data accesses. Enable/Disable L1 Region Prefetcher. Options available: Disable, Enable, Auto. Default setting is Auto .
L2 Stream HW Prefetcher	Enable/Disable L2 Stream HW Prefetcher. Options available: Disable, Enable, Auto. Default setting is Auto .
L2 Up/Down Prefetcher	Use memory access history to determine whether to fetch the next or previous line for all memory accesses. Enable/Disable L2 Up/Down Prefetcher. Options available: Disable, Enable, Auto. Default setting is Auto .
L1 Burst Prefetch Mode	Enable/Disable L1 Burst Prefetch Mode. Options available: Disable, Enable, Auto. Default setting is Auto .

2-3-1-3 Core Watchdog

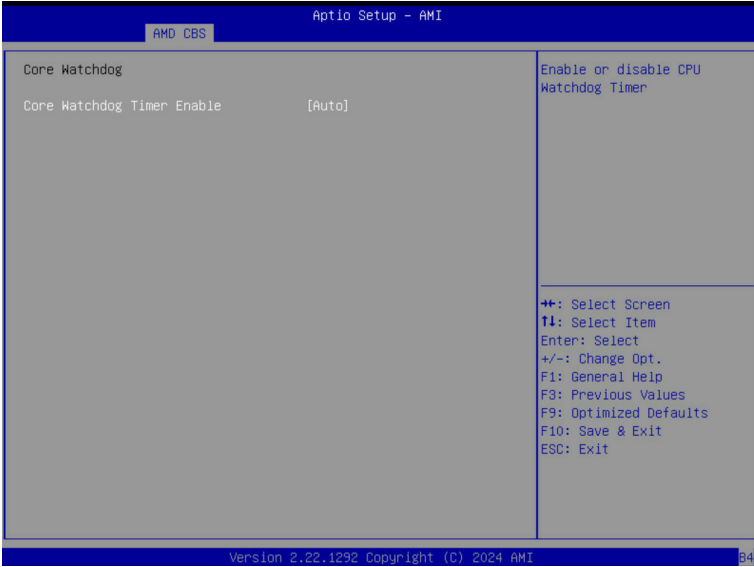

Parameter	Description
Core Watchdog	
Core Watchdog Timer Enable ^(Note)	Enable/Disable CPU Watchdog Timer. Options available: Disabled, Enabled, Auto. Default setting is Auto . Select the CPU Watchdog Timer interval.
Core Watchdog Timer Interval	Options available: 2.681s, 1.340s, 669.41ms, 334.05ms, 166.37ms, 82.53ms, 40.61ms, 20.970ms, 10.484ms, 5.241ms, 2.620ms, 1.309ms, 654.08us, 326.4us, 162.56us, 80.64us, 39.68us, Auto. Default setting is Auto .

(Note) Advanced items prompt when this item is defined.

2-3-2 DF Common Options

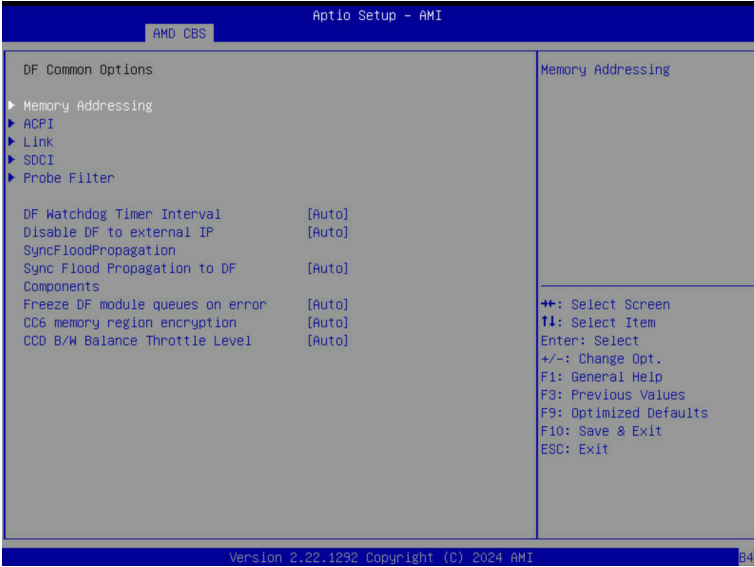

Parameter	Description
DF Common Options	
Memory Addressing	Press [Enter] for configuration of advanced items.
ACPI	Press [Enter] for configuration of advanced items.
Link	Press [Enter] for configuration of advanced items.
SDCI	Press [Enter] for configuration of advanced items.
DF Watchdog Timer Interval	Configures the Data Fabric watchdog timer interval. Options available: Auto, 41ms, 166ms, 334ms, 669ms, 1.34 seconds, 2.68 seconds, 5.36 seconds. Default setting is Auto .
Disable DF to external IP sync flood propagation	Enable/Disable SyncFlood to UMC & downstream slaves. Options available: Sync flood disabled, Sync flood enabled, Auto. Default setting is Auto .
Sync flood propagation to DF Components	Enable/Disable DF Sync Flood propagation. Options available: Sync flood disabled, Sync flood enabled, Auto. Default setting is Auto .
Freeze DF module queues on error	Options available: Disabled, Enabled, Auto. Default setting is Auto .
CC6 memory region encryption	Controls whether or not the CC6 save/restor memory is encrypted. Options available: Disabled, Enabled, Auto. Default setting is Auto .
CCD B/W Balance Throttle Level	Options available: Auto, Level 0, Level 1, Level 2, Level 3, Level 4. Default setting is Auto .

2-3-2-1 Memory Addressing

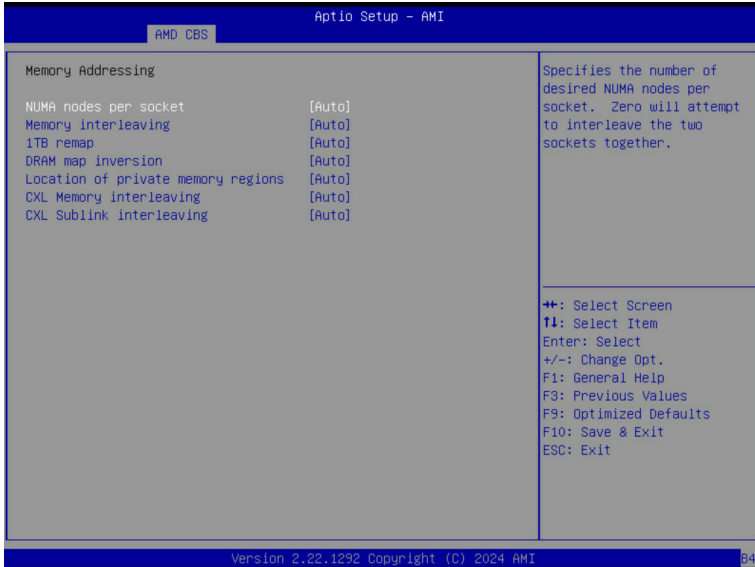

Parameter	Description
Memory Addressing	
NUMA nodes per socket	Specifies the number of desired NUMA nodes per socket. Options available: NPS0, NPS1, Auto. Default setting is Auto .
Memory interleaving	Enable/Disable the Memory interleaving feature. Options available: Disabled, Auto, Enabled. Default setting is Auto .
1TB remap	Enable/Disable to remap DRAM out of the space just below the 1TB boundary. The ability to remap depends on DRAM configuration, NPS, and interleaving selection, and may not always be possible. Options available: Do not remap, Attempt to remap, Auto. Default setting is Auto .
DRAM map inversion	Enable/Disable the DRAM map inversion function. Options available: Disabled, Enabled, Auto. Default setting is Auto .
Location of private memory regions	Controls whether or not the private memory regions (PSP, SMU and CC6) are at the top of DRAM or distributed. Options available: Distributed, Consolidated, Auto. Default setting is Auto .
CXL Memory interleaving	Options available: Disabled, Enabled, Auto. Default setting is Auto .
CXL Sublink interleaving	Options available: Enable, Disable, Auto. Default setting is Auto .

2-3-2-2 ACPI

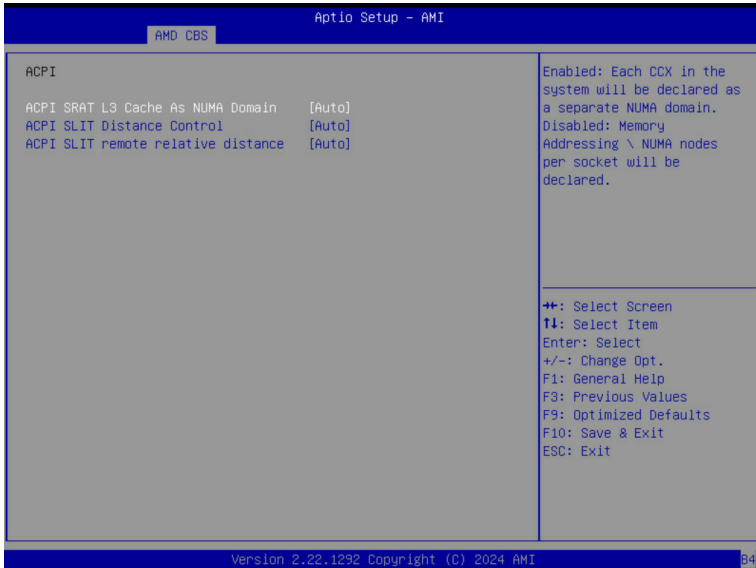

Parameter	Description
ACPI	
ACPI SRAT L3 Cache As NUMA Domain	Enable/Disable report each L3 cache as a NUMA Domain to the OS. Options available: Disabled, Enabled, Auto. Default setting is Auto .
ACPI SLIT Distance Control	Determines how the SLIT distances are declared. Options available: Manual, Auto. Default setting is Auto .
ACPI SLIT remote relative distance	Sets the remote socket distance for 2P systems as near (2.8) or far (3.2). Options available: Near, Far, Auto. Default setting is Auto .

2-3-2-3 Link

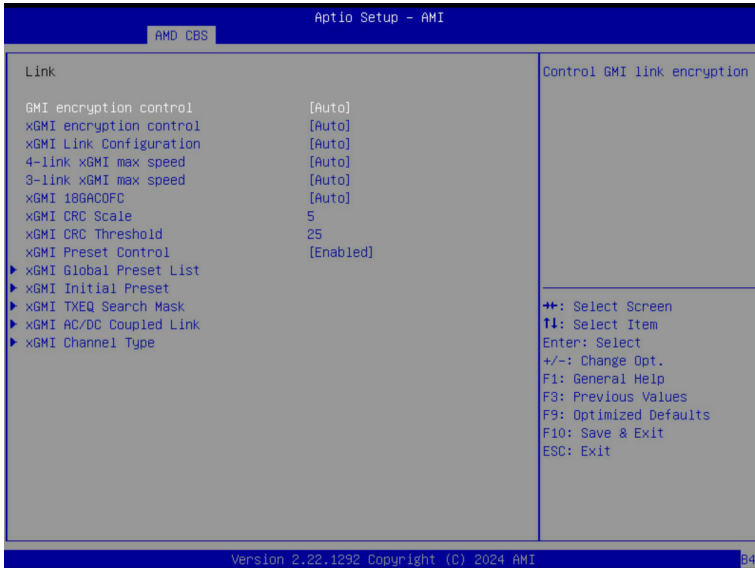

Parameter	Description
GMI encryption control	Enable/Disable GMI link encryption. Options available: Disabled, Enabled, Auto. Default setting is Auto .
xGMI encryption control	Enable/Disable xGMI link encryption. Options available: Disabled, Enabled, Auto. Default setting is Auto .
xGMI Link Configuration	Configures the number of xGMI2 links used on a multi-socket system. Options available: Auto, 3 xGMI Links, 4 xGMI Links. Default setting is Auto .
4-link xGMI max speed	Specifies the max speed of 4-link xGMI. Options available: 12Gbps, 16Gbps, 17Gbps, 18Gbps, 20Gbps, 22Gbps, 23Gbps, 24Gbps, 25Gbps, 26Gbps, 27Gbps, 30Gbps, 32Gbps, Auto. Default setting is Auto .
3-link xGMI max speed	Specifies the max speed of 3-link xGMI. Options available: 12Gbps, 16Gbps, 17Gbps, 18Gbps, 20Gbps, 22Gbps, 23Gbps, 24Gbps, 25Gbps, 26Gbps, 27Gbps, 30Gbps, 32Gbps, Auto. Default setting is Auto .
xGMI 18GACOFC	Configures xGMI 18GACOFC. Options available: Auto, Enable, Disable. Default setting is Auto .
xGMI CRC Scale	Configures leaky bucket scale for xGMI and WAFL CRC errors. Every scale milliseconds an error will leak from the CRC counter. Default setting is 7 .
xGMI CRC Threshold	Configures leaky bucket threshold for xGMI and WAFL CRC errors. If link CRC counter exceeds this threshold, an error will be logged. Default setting is 25 .
xGMI Preset Control	Enable/Disable xGMI Preset control. Options available: Disabled, Enabled, Auto. Default setting is Auto .

Parameter	Description
xGMI Global Preset List	Press [Enter] to configure the xGMI Preset list.
xGMI Initial Preset	Press [Enter] to configure the xGMI Initial Preset CPU0/1 link.
xGMI TXEQ Search Mask	Press [Enter] to configure the xGMI TXEQ Search Mask CPU0/1 link.
xGMI AC/DC Coupled Link	Press [Enter] to configure the xGMI AC/DC Coupled link. ♦ xGMI AC/DC Coupled Link Control ^(Note) – Options available: Manual, Auto. Default setting is Auto .
xGMI Channel Type	Press [Enter] to configure the xGMI Channel Type. ♦ xGMI Channel Type Control ^(Note) – Options available: Manual, Auto. Default setting is Auto .

(Note) Advanced items prompt when this item is defined.

2-3-2-4 SDCI

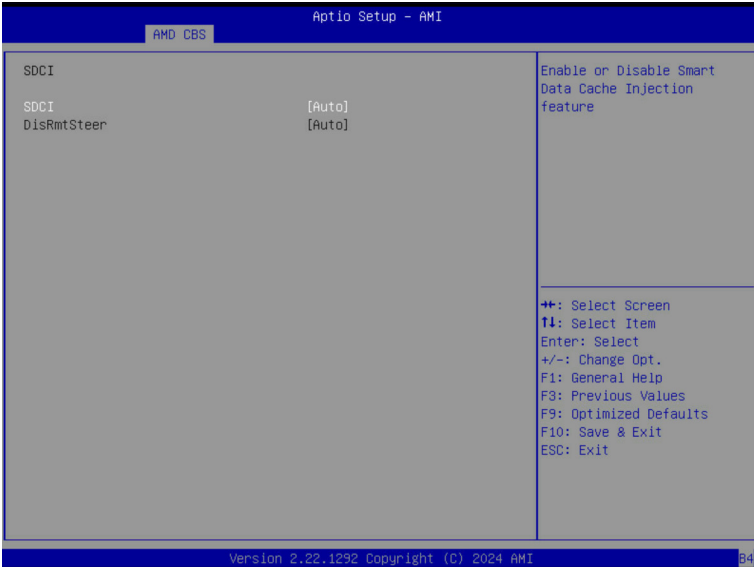

Parameter	Description
SDCI ^(Note)	Options available: Disabled, Enabled, Auto. Default setting is Auto .
DisRmSteer	Options available: Disabled, Enabled, Auto. Default setting is Auto .

(Note) Advanced items prompt when this item is defined.

2-3-2-5 Probe Filter

AMD CBS		Aptio Setup - AMI	
Probe Filter		Specifies whether multiple memory/CXL channels will share probe filter storage. For memory sizes of 16TB or larger, this feature is ignored as it is auto-selected to 'shared'	
Organization	[Dedicated]		
Periodic Directory Rinse (PDR)	[Auto]		
Tuning			
		⚡: Select Screen ↑↓: Select Item Enter: Select +/-: Change Opt. F1: General Help F3: Previous Values F9: Optimized Defaults F10: Save & Exit ESC: Exit	
Version 2.22.1292 Copyright (C) 2024 AMI		84	

2-3-3 UMC Common Options

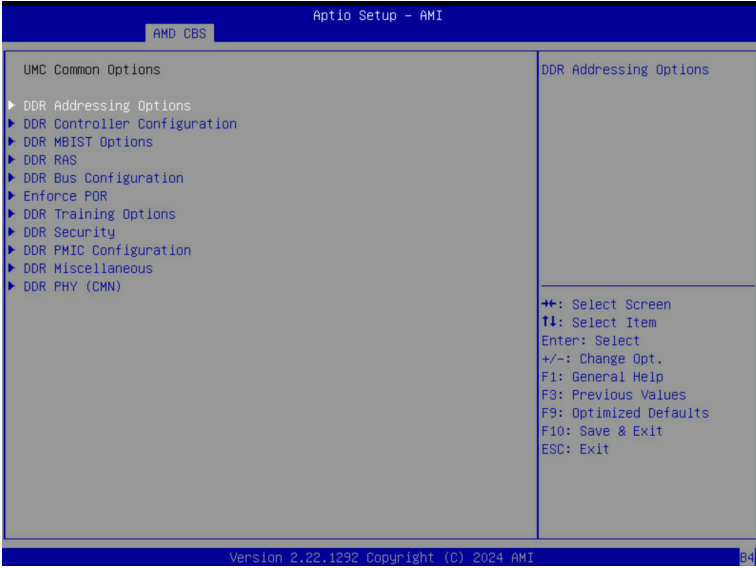

Parameter	Description
UMC Common Options	
DDR Addressing Options	Press [Enter] for configuration of advanced items.
DDR Controller Configuration	Press [Enter] for configuration of advanced items.
DDR MBIST Options	Press [Enter] for configuration of advanced items.
DDR RAS	Press [Enter] for configuration of advanced items.
DDR Bus Configuration	Press [Enter] for configuration of advanced items.
DDR Timing Configuration	Press [Enter] for configuration of advanced items.
DDR Training Options	Press [Enter] for configuration of advanced items.
DDR Security	Press [Enter] for configuration of advanced items.
DDR PMIC Configuration	Press [Enter] for configuration of advanced items.
DDR Miscellaneous	Press [Enter] for configuration of advanced items.

2-3-3-1 DDR Addressing Options

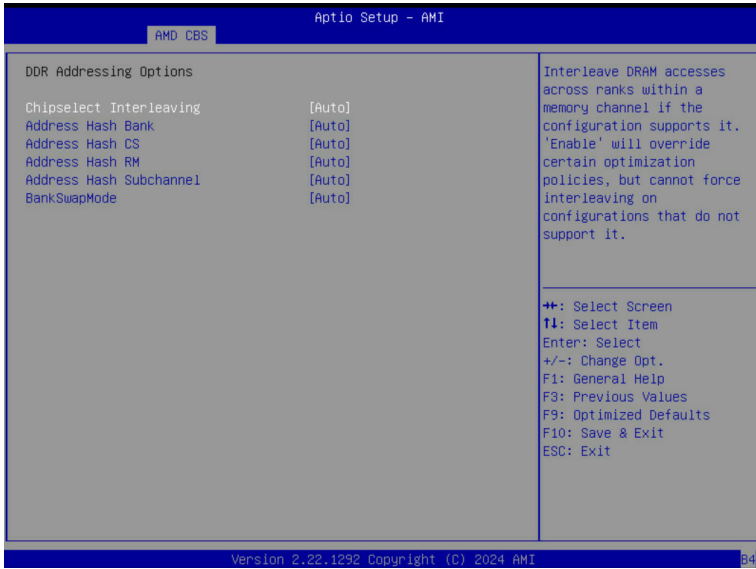

Parameter	Description
DDR Addressing Options	
Chipselect Interleaving	Interleaves memory blocks across the DRAM chip selects for node 0. Options available: Disabled, Auto. Default setting is Auto .
Address Hash Bank	Enable or disable bank addressing hashing. Options available: Disabled, Enabled, Auto. Default setting is Auto .
Address Hash CS	Enable or disable CS addressing hashing. Options available: Auto, Enabled, Disabled. Default setting is Auto .
Address Hash Rm	Enable or disable RM addressing hashing. Options available: Auto, Enabled, Disabled. Default setting is Auto .
Address Hash Subchannel	Enable or disable sub-channel addressing hashing. Options available: Auto, Enabled, Disabled. Default setting is Auto .
Bank SwapMode	Options available: Auto, Disabled, Swap CPU. Default setting is Auto .

2-3-3-2 DDR Controller Configuration



Parameter	Description
DDR Cotroller Configuration	
DDR Power Options	Press [Enter] for configuration of advanced items.
Memory Channel Disable	Press [Enter] for configuration of advanced items.
Refresh Management (RFM)	Press [Enter] for configuration of advanced items.

2-3-3-2-1 DDR Power Options

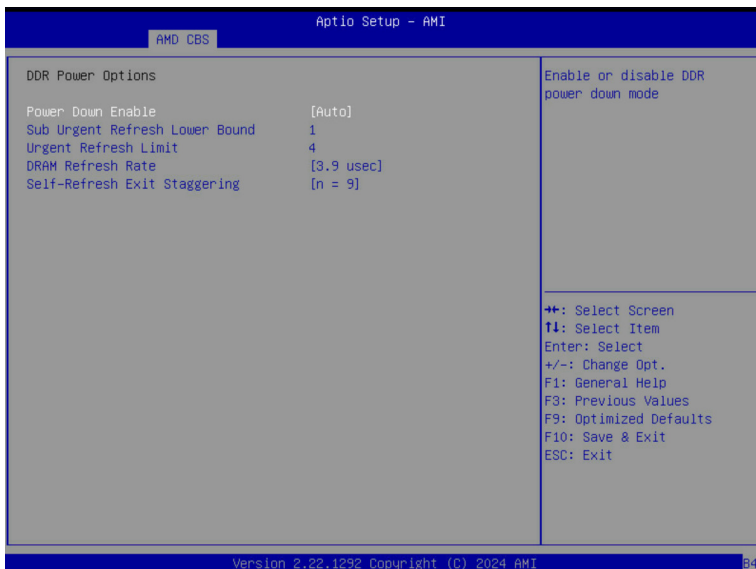

Parameter	Description
DDR Power Options	
Power Down Enable	Enable or disable DDR power down mode. Options available: Disabled, Enabled, Auto. Default setting is Auto .
Sub Urgent Refresh Lower Bound	Specifies the stored refresh limit required to enter sub-urgent refresh mode.
Urgent Refresh Limit	Specifies the stored refresh limit required to enter urgent refresh mode.
DRAM Refresh Rate	DRAM refresh rate: 1.95us or 3.9us. Options available: 3.9 usec, 1.95usec. Default setting is 3.9 usec .
Self-Refresh Exit Staggering	Options available: Disabled, n=1~9. Default setting is n=9 .

2-3-3-2-2 Memory Channel Disable

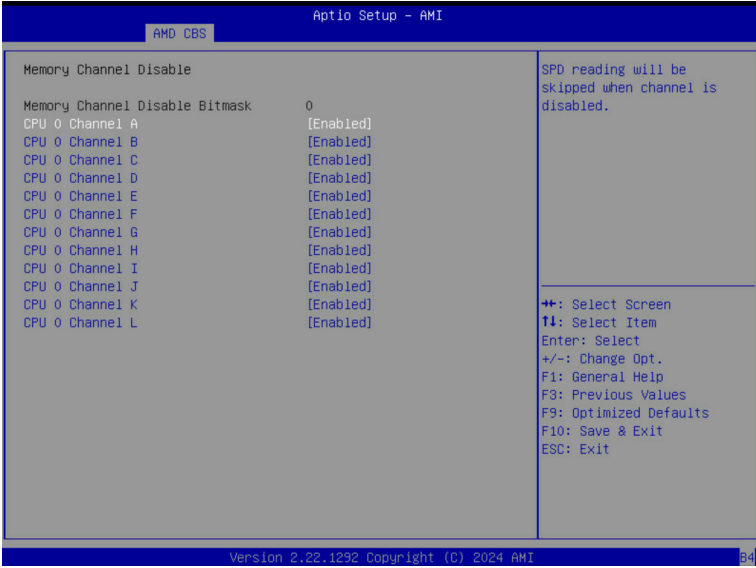

Parameter	Description
Memory Channel Disable	
Memory Channel Disable Bitmask	
CPU0/CPU1 Channel_#	Press [Enter] to enable/disable specific memory channel.

2-3-3-2-3 Refresh Management (RFM)

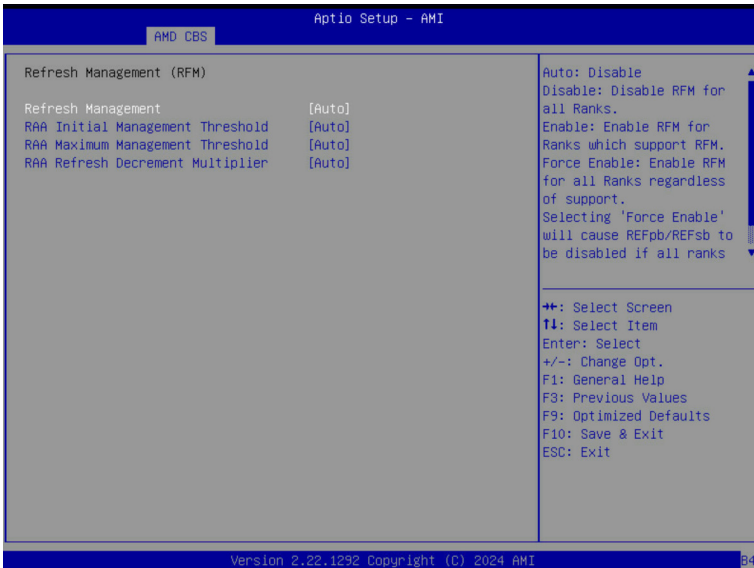

Parameter	Description
Refresh Management (RFM)	
Refresh Management	Configure Refresh Management. Options available: Enable, Disable, Auto, Force Enable. Default setting is Auto .
RAA Initial Management Threshold	Override Rolling Accumulated ACT Initial Management Threshold. Options available: 32, 40, 48, 56, 64, 72, 80, Auto. Default setting is Auto .
RAA Maximum Management Threshold	Override Rolling Accumulated ACT Maximum Management Threshold. Options available: 3X, 4X, 5X, 6X, Auto. Default setting is Auto .
RAA Refresh Decrement Multiplier	Override RAA Refresh Decrement Multiplier. Options available: 0.5, 1, Auto. Default setting is Auto .

2-3-3-3 DDR MBIST Options

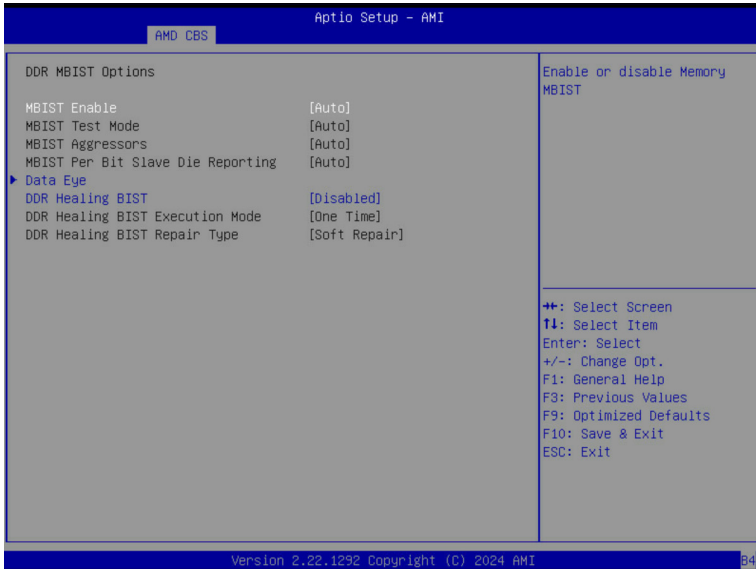

Parameter	Description
DDR MBIST Options	
MBIST Enable	Enable/Disable the Memory MBIST function. Options available: Disabled, Enabled, Auto. Default setting is Auto .
MBIST Test Mode ^(Note1)	Selects MBIST Test Mode. Interface Mode: Tests Single and Multiple CS transactions and Basic Connectivity. Data Eye Mode: Measures Voltage vs. Timing. Options available: Auto, Both, Interface Mode, Data Eye Mode. Default setting is Auto .
MBIST Aggressors ^(Note1)	Enable/Disable MBIST Aggressor test. Options available: Auto, Enabled, Disabled. Default setting is Auto .
MBIST Per Bit Slave Die Reporting ^(Note1)	Enable/Disable to report 2D data eye results in ABL log for each DQ, Chipselect, and Channel. Options available: Auto, Enabled, Disabled. Default setting is Auto .
Data Eye	Press [Enter] to configure advanced items.
Memory Healing BIST	Enable/Disable memory healing BIST. Options available: Disabled, PMU Mem BIST, Self-Healing Mem BIST, PMU and Self-Healing Mem BIST. Default setting is Disabled .

(Note1) This item appears when **MBIST Enable** is set to **Enabled**.

Parameter	Description
DDR Healing BIST Execution Mode ^(Note2)	Options available: One Time, Every boot. Default setting is One Time .
PMU Mem BIST Algorithm ^(Note2)	Press [Enter] to enable/disable PMU Mem BIST Algorithm.
DDR Healing BIST Repair Type ^(Note2)	For DRAM errors found in the BIOS memory BIST select the repair type. Options available: Soft Repair, Hard Repair, No Rrepairs -Test only. Default setting is Soft Repair .

(Note2) This item appears when **DDR Healing BIST** is defined.

2-3-3-3-1 Data Eye

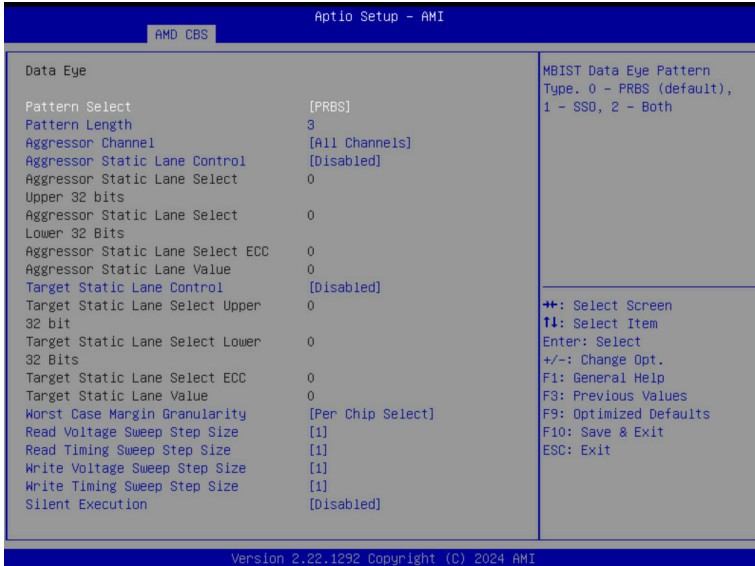

Parameter	Description
Data Eye	
Pattern Select	Options available: PRBS, SSO, Both. Default setting is PRBS .
Pattern Length	Determines the pattern length. The possible options are N=3....12.
Aggressor Channel	This item helps read the aggressors channels. Options available: One Sub-Channel, Half Channels, All Channels. Default setting is All Channels .
Aggressor Static Lane Control	Enable/Disable the Aggressor Static Lane Control function. Options available: Enabled, Disabled. Default setting is Disabled .
Aggressor Static Lane Select Upper 32 bits	This item is configurable when Aggressor Static Lane Control is set to Enabled .
Aggressor Static Lane Select Lower 32 bits	This item is configurable when Aggressor Static Lane Control is set to Enabled .
Aggressor Static Lane Select ECC	This item is configurable when Aggressor Static Lane Control is set to Enabled .
Aggressor Static Lane Value	This item is configurable when Aggressor Static Lane Control is set to Enabled .
Target Static Lane Control	Enable/Disable the Target Static Lane Control function. Options available: Enabled, Disabled. Default setting is Disabled .

Parameter	Description
Target Static Lane Select Upper 32 bits	This item is configurable when Target Static Lane Control is set to Enabled .
Target Static Lane Select Lower 32 bits	This item is configurable when Target Static Lane Control is set to Enabled .
Target Static Lane Select ECC	This item is configurable when Target Static Lane Control is set to Enabled .
Target Static Lane Value	This item is configurable when Target Static Lane Control is set to Enabled .
Worst Case Margin Granularity	Configures Worst Case Margin Granularity. Options available: Per Chip Select, Per Nibble. Default setting is Per Chip Select .
Read Voltage Sweep Step Size	Configures the step size for read Data Eye voltage sweep. Options available: 1, 2, 4. Default setting is 1.
Read Timing Sweep Step Size	Configures the step size for read Data Eye timing sweep. Options available: 1, 2, 4. Default setting is 1.
Write Voltage Sweep Step Size	Configures the step size for write Data Eye voltage sweep. Options available: 1, 2, 4. Default setting is 1.
Write Timing Sweep Step Size	Configures the step size for write Data Eye timing sweep. Options available: 1, 2, 4. Default setting is 1.
Silent Execution	Execute MBIST Data Eye silently without ABL log output. Options available: Enabled, Disabled. Default setting is Disabled .

2-3-3-4 DDR RAS

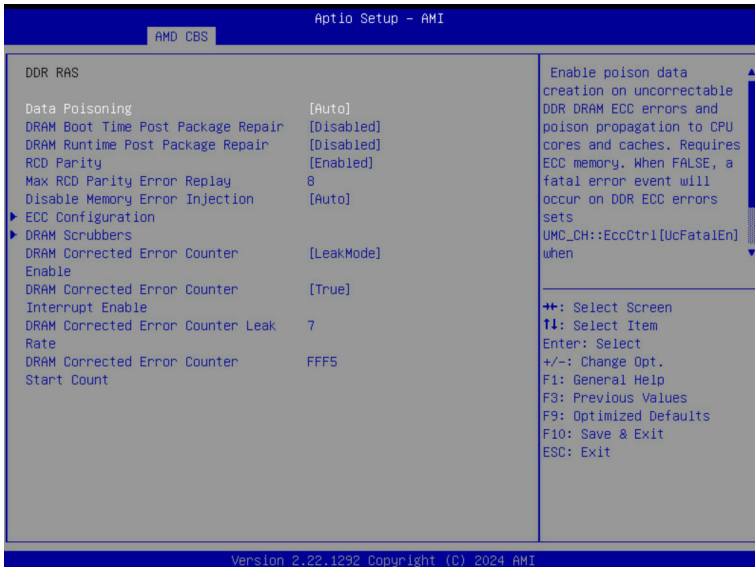

Parameter	Description
DDR RAS	
Data Poisoning	Enable/Disable the Data Poisoning function. Options available: Auto, Enabled, Disabled. Default setting is Auto .
DRAM Boot Time Post Package Repair	Enable/Disable the DRAM Boot Time Post Package Repair function. Options available: Enable, Disable. Default setting is Disable .
DRAM Runtime Post Package Repair	Enable/Disable the DRAM Runtime Post Package Repair function. Options available: Enable, Disable. Default setting is Disable .
RCD Parity	Enable/Disable the RCD Parity function. Options available: Auto, Enabled, Disabled. Default setting is Enabled .
Max RCD Parity Error Replay	Default setting is 8 .
Write CRC	Enable/Disable the Write CRC function. Options available: Auto, Enabled, Disabled. Default setting is Enabled .
Max Write CRC Error Replay	Default setting is 8 .
Read CRC	Enable/Disable the Read CRC function. Options available: Auto, Enabled, Disabled. Default setting is Enabled .
Max Read CRC Error Replay	Default setting is 8 .
Disable Memory Error Injection	Options available: False, True, Auto. Default setting is Auto .
ECC Configuration	Press [Enter] to configure advanced items. <ul style="list-style-type: none"> ◆ DRAM ECC Symbol Size <ul style="list-style-type: none"> – Configures the DRAM ECC Symbol Size. – Options available: Auto, x4, x16. Default setting is Auto.

Parameter	Description
ECC Configuration (continued)	<ul style="list-style-type: none"> ◆ DRAM ECC Enable <ul style="list-style-type: none"> – Enable/Disable DRAM ECC. When set to Auto, it will set ECC to enable. – Options available: Auto, Enabled, Disabled. Default setting is Auto. ◆ DRAM UECC Retry <ul style="list-style-type: none"> – Enable/Disable DRAM UECC Retry. – Options available: Auto, Enabled, Disabled. Default setting is Disabled. ◆ Max DRAM UECC Error Replay^(Note) <ul style="list-style-type: none"> – Default setting is 8. ◆ Memory Clear <ul style="list-style-type: none"> – Options available: Auto, Enabled, Disabled. Default setting is Auto. ◆ Address XDR after ECC <ul style="list-style-type: none"> – Options available: Auto, Enabled, Disabled. Default setting is Disabled.
DRAM Scrubbers	<p data-bbox="399 647 732 666">Press [Enter] to configure advanced items.</p> <ul style="list-style-type: none"> ◆ DRAM ECS Mode <ul style="list-style-type: none"> – Options available: Auto, AutoECS, ManualECS, DisableECS. Default setting is Auto. ◆ DRAM Redirect Scrubber Enable <ul style="list-style-type: none"> – Options available: Auto, Enabled, Disabled. Default setting is Auto. ◆ DRAM Scrub Redirection Limit <ul style="list-style-type: none"> – Options available: Auto, 8 Scrubs, 4 Scrubs, 2 Scrubs, 1 Scrub. Default setting is Auto. ◆ DRAM Scrub Time <ul style="list-style-type: none"> – Options available: Disabled, 1 hour, 4 hours, 6 hours, 8 hours, 12 hours, 16 hours, 24 hours, 48 hours. Default setting is 24 Hours. ◆ DRAM Error Threshold Count <ul style="list-style-type: none"> – Options available: Auto, ETC_4, ETC_16, ETC_64, ETC_256, ETC_1024, ETC_4096. Default setting is Auto. ◆ DRAM ECS Count Mode <ul style="list-style-type: none"> – Options available: Auto, Row Count Mode, Code Word Count Mode. Default setting is Auto. ◆ DRAM AutoEcs during Self Refresh <ul style="list-style-type: none"> – Options available: Auto, AutoEcs Disabled, AutoEcs Enabled. Default setting is Auto. ◆ DRAM ECS WriteBack Suppression <ul style="list-style-type: none"> – Options available: Auto, Enable, Disable. Default setting is Auto.

(Note) This item available when **DRAM UECC Retry** is set to **Enabled**.

Parameter	Description
DRAM Scrubbers (continued)	<ul style="list-style-type: none"> ◆ DRAM X4 WriteBack Suppression <ul style="list-style-type: none"> – Options available: Auto, Enable, Disable. Default setting is Auto.
DRAM Corrected Error Counter Enable	Configure DRAM Corrected Error Counter function. Options available: Disable, NoLeakMode, Leak Mode. Default setting is Leak Mode .
DRAM Corrected Error Counter Interrupt Enable	Enable SMI when DRAM corrected Error Counter count exceeds the threshold value. Options available: False, True. Default setting is True .
DRAM Corrected Counter Leak Rate	Program Rate value for DRAM Corrected Error Counter function. Default setting is 7 .
DRAM Corrected Error Counter Start Count	Program starting value for DRAM Corrected Error Counter function. Default setting is FFF5 .

2-3-3-5 DDR Bus Configuration

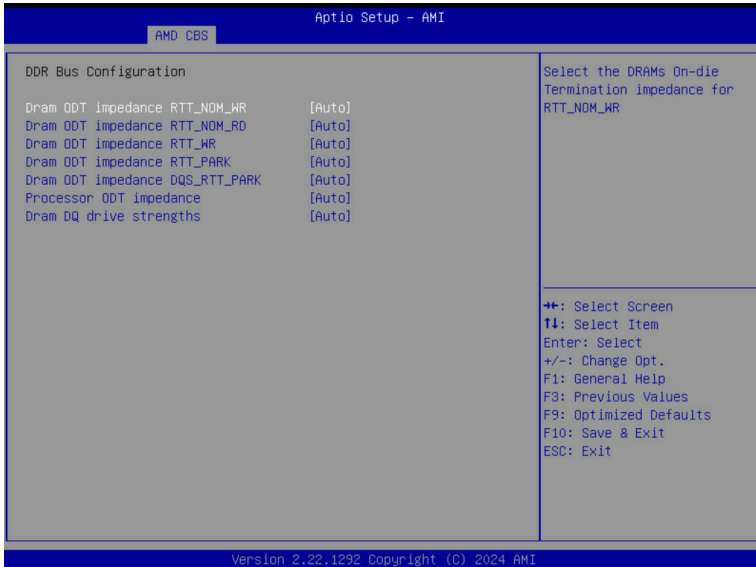

Parameter	Description
DDR Bus Configuration	
Dram ODT impedance RTT_NOM_WR	Select the DRAMs On-die Termination impedance for RTT_NOM_WR. Options available: Auto, RTT_OFF, RZQ (240), RZQ/2 (120), RZQ/3 (80) RZQ/4 (60), RZQ/5(48), RZQ/6(40), RZQ/7(34). Default setting is Auto .
Dram ODT impedance RTT_NOM_RD	Select the DRAMs On-die Termination impedance for RTT_NOM_RD. Options available: Auto, RTT_OFF, RZQ (240), RZQ/2 (120), RZQ/3 (80) RZQ/4 (60), RZQ/5(48), RZQ/6(40), RZQ/7(34). Default setting is Auto .
Dram ODT impedance RTT_WR	Select the DRAMs On-die Termination impedance for RTT_WR. Options available: Auto, RTT_OFF, RZQ (240), RZQ/2 (120), RZQ/3 (80) RZQ/4 (60), RZQ/5(48), RZQ/6(40), RZQ/7(34). Default setting is Auto .
Dram ODT Timpedance RTT_PARK	Select the DRAMs On-die Termination impedance for RTT_PARK. Options available: Auto, RTT_OFF, RZQ (240), RZQ/2 (120), RZQ/3 (80) RZQ/4 (60), RZQ/5(48), RZQ/6(40), RZQ/7(34). Default setting is Auto .
Dram ODT Timpedance DQS_RTT_PARK	Select the DRAMs On-die Termination impedance for DQS_RTT_PARK. Options available: Auto, RTT_OFF, RZQ (240), RZQ/2 (120), RZQ/3 (80) RZQ/4 (60), RZQ/5(48), RZQ/6(40), RZQ/7(34). Default setting is Auto .

Parameter	Description
Processor ODT impedance	Select the ODT impedance for all DBYTE IOs. Options available: Auto, High Impedance, 480 ohm, 240 ohm, 160 ohm, 120 ohm, 96 ohm, 80 ohm, 68.6 ohm, 60 ohm, 53.3 ohm, 48 ohm, 43.6 ohm, 40 ohm, 36.9 ohm, 34.3 ohm, 32 ohm, 30 ohm, 28.2 ohm, 26.7 ohm, 25.3 ohm. Default setting is Auto .
Dram DQ drive strengths	Select the Dram Pull-up and Pull-Down Output Driver Impedance for all DQ and DMI IOs.. Options available: Auto, 48 ohm, 40 ohm, 34 ohm, Default setting is Auto .

2-3-3-6 Enforce POR

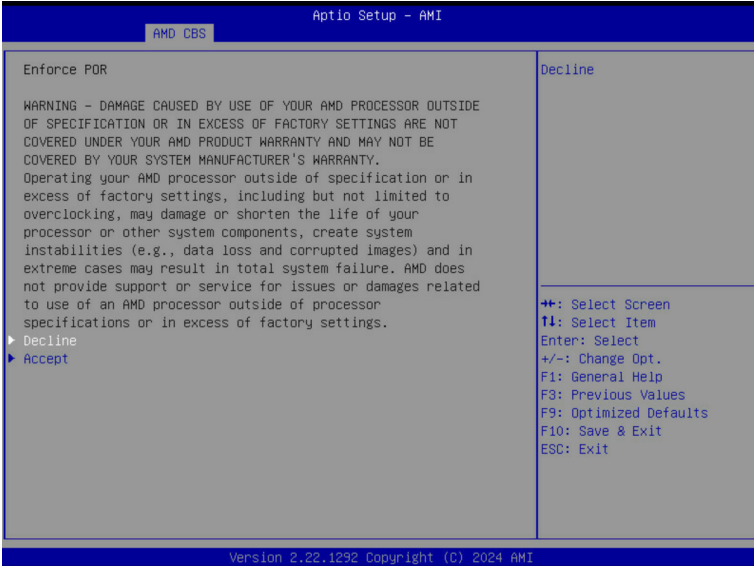

Parameter	Description
Enforce POR	Decline/Accept to configure the advanced items.
Accept	
Active Memory Timing Settings ^(Note)	Active memory Timing Settings. Options available: Auto, Enabled. Default setting is Auto .
Memory Target Speed	Specifies the memory target speed in MT/s. Options available: Auto, DDR3200, DDR3600, DDR4000, DDR4400, DDR4800, DDR5200, DDR5600. Default setting is Auto .
SPD Timing	Press [Enter] to configure advanced items.
Non-SPD Timing	Press [Enter] to configure advanced items.

(Note) Advanced items prompt when this item is defined.

2-3-3-7 DDR Training Options

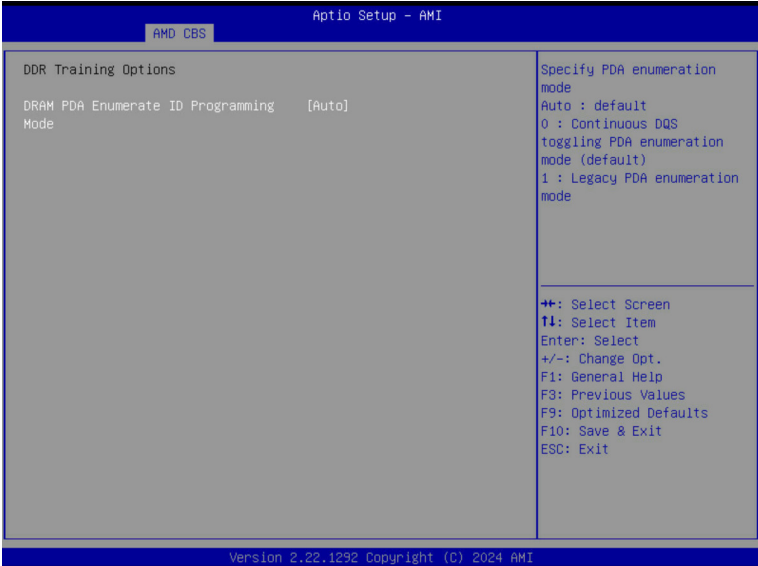

Parameter	Description
DDR Training Options	
DRAM PDA Enumerate ID Programming Mode	Specify PDA enumeration mode. Options available: Auto, Toggling PDA enumeration mode, Legacy PDA enumeration mode. Default setting is Auto .

2-3-3-8 DDR Security



Parameter	Description
Security	
TSME	Enable/Disable Transparent SME. Options available: Auto, Enabled, Disabled. Default setting is Auto .
AES	Options available: AES-128, AES-256. Default setting is AES-256 .
Data Scramble	Enable/Disable Data Scrambling. Options available: Enabled, Disabled. Default setting is Enabled .
SME-MK	Options available: Enabled, Disabled. Default setting is Disabled .

2-3-3-9 DDR PMIC Configuration



Parameter	Description
DDR PMIC Configuration	
PMIC Error Reporting	Enables support for PMIC Error Reporting. Options available: Auto, False, True. Default setting is Auto .
PMIC Operation Mode	Options available: Secure Mode, Programmable Mode. Default setting is Programmable Mode .
PMIC Fault Recovery	Options available: Always, Never, Once. Default setting is Always .
PMIC SWC VDDIO	Default setting is 1100 .
PMIC SWA/SWB VDD Core	Default setting is 1100 .
PMIC Stagger Delay	Default setting is 5 .
Max PMIC Power On	Default setting is FF .

2-3-3-10 DDR Miscellaneous

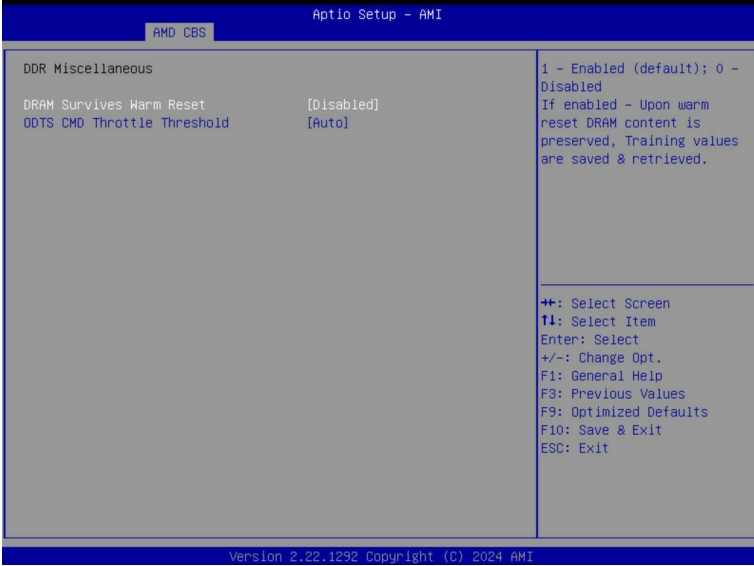

Parameter	Description
DDR Miscellaneous	
DRAM Survives Warm Reset	Options available: Enabled, Disabled. Default setting is Enabled .

2-3-3-11 DDR PHY (CMN)



Parameter	Description
DDR PHY (CMN)	
Periodic Training ^(Note)	Options available: Auto, Enabled, Disabled. Default setting is Auto .
Periodic Training Interval	Specifies the Periodic Training interval in millisecond.

(Note) Advanced items prompt when this item is defined.

2-3-4 NBIO Common Options

AMD CBS Aptio Setup - AMI

NBIO Common Options		Enable/Disable IOMMU
IOMMU	[Enabled]	
DMAR Support	[Auto]	
DMA Protection	[Auto]	
DRTM Virtual Device Support	[Auto]	
DRTM Memory Reservation	[Auto]	
ACS Enable	[Auto]	
PCIe ARI Support	[Auto]	
PCIe ARI Enumeration	[Auto]	
PCIe Ten Bit Tag Support	[Auto]	
▶ SMU Common Options		
▶ NBIO RAS Common Options		
Enable AER Cap	[Auto]	++: Select Screen
Early Link Speed	[Auto]	T1: Select Item
Hot Plug Handling mode	[Auto]	Enter: Select
Hot Plug Allow FF in Synchronous	[Disabled]	+/-: Change Opt.
Presence Detect Select mode	[Auto]	F1: General Help
Data Link Feature Cap	[Auto]	F3: Previous Values
CV test	[Auto]	F9: Optimized Defaults
SEV-SNP Support	[Auto]	F10: Save & Exit
Allow Compliance	[Auto]	ESC: Exit
SRIS	[Auto]	
Multi Upstream Auto Speed Change	[Auto]	

Version 2.22.1292 Copyright (C) 2024 AMI

AMD CBS Aptio Setup - AMI

▶ NBIO RAS Common Options		No help string
Enable AER Cap	[Auto]	
Early Link Speed	[Auto]	
Hot Plug Handling mode	[Auto]	
Hot Plug Allow FF in Synchronous	[Disabled]	
Presence Detect Select mode	[Auto]	
Data Link Feature Cap	[Auto]	
CV test	[Auto]	
SEV-SNP Support	[Auto]	
Allow Compliance	[Auto]	
SRIS	[Auto]	
Multi Upstream Auto Speed Change	[Auto]	
Multi Auto Speed Change On Last Rate	[Auto]	
PCIe Link Speed Capability	[Auto]	++: Select Screen
RTM Margining Support	[Auto]	T1: Select Item
EQ Bypass To Highest Rate	[Auto]	Enter: Select
Non-PCIe Compliant Support	[Auto]	+/-: Change Opt.
PCIe Idle Power Setting	[Optimize for Perf/Power]	F1: General Help
▶ nBif Common Options		F3: Previous Values
▶ Link EQ Preset Options		F9: Optimized Defaults
Enable 2 SPC (Gen 4)	[Auto]	F10: Save & Exit
Safe recovery upon a BERExceeded Error	[Auto]	ESC: Exit
Periodic Calibration	[Auto]	

Version 2.22.1292 Copyright (C) 2024 AMI

Parameter	Description
NBIO Common Options	
IOMMU	Enable/Disable the IOMMU function. Options available: Disabled, Enabled. Default setting is Enabled .
DMAr Support	Enable/Disable DMAr system protection during POST. Options available: Disabled, Enabled, Auto. Default setting is Auto .
DMA Protection	Enable/Disable DMA remap support in IVRS IVinfo Field. Options available: Auto, Enabled, Disabled. Default setting is Auto .
DRTM Virtual Device Support	Enable/Disable DRTM ACPI virtual device. Options available: Disabled, Enabled, Auto. Default setting is Auto .
DRTM Memory Reservation	Enable/Disable DRTM Memory reservation. Options available: Disabled, Enabled, Auto. Default setting is Auto .
ACS Enable	Enable/Disable ACS. Options available: Enable, Disabled, Auto. Default setting is Auto .
PCIe ARI Support	Enable/Disable Alternative Routing-ID Interpretation. Options available: Disable, Enable, Auto. Default setting is Auto .
PCIe ARI Enumeration	ARI Forwarding Enable for each downstream port. Options available: Disable, Enable, Auto. Default setting is Auto .
PCIe Ten Bit Tag Support	Enable/Disable PCIe ten bit tags for supported devices. (Auto=Disabled) Options available: Disable, Enable, Auto. Default setting is Auto .
SMU Common Options	Press [Enter] for configuration of advanced items.
NBIO RAS Common Options	Press [Enter] for configuration of advanced items.
Enable AER Cap	Enable/Disable Advanced Error Reporting Capability. Options available: Enable, Disabled, Auto. Default setting is Auto .
Early Link Speed	Configures Early Link Speed. Options available: Auto, Gen1, Gen2. Default setting is Auto .
Hot Plug Handling mode	Controls the Hot Plug Handling mode. Options available: OS First, Firmware First/EDR if OS supports, Firmware First but allow OS First, System Firmware Intermediary, Auto. Default setting is Auto .
Hot Plug Allow FF in Synchronous	Allows firmware first hot plug handling mode to operate in mode A and mode B synchronous mappings. Options available: Disabled, Enabled. Default setting is Disabled .
Presence Detect Select mode	Controls the Presence Detect Select mode. Options available: OR, AND, Auto. Default setting is Auto .

Parameter	Description
Data Link Feature Cap	Enable/Disable the data link feature capability. Options available: Enabled, Disabled, Auto. Default setting is Auto .
CV test	Enable/Disable the running PCIE CV tool support. Options available: Auto, Enabled, Disabled. Default setting is Auto .
SEV-SNP Support	Enable/Disable the SEV-SNP support. Options available: Disable, Enable. Default setting is Disable .
Allow Compliance	When enabled, allows the PCIe RP to enter Polling.Compliance state. Options available: Auto, Disable, Enable. Default setting is Auto .
SRIS	Options available: Auto, Disable, Enable. Default setting is Auto .
Multi Upstream Auto Speed Change	Defines the setting of this feature for all PCIe devices. Options available: Disabled, Enabled, Auto. Default setting is Auto .
Multi Auto Speed Change On Last Rate	Options available: Disable, Enable, Auto. Default setting is Auto .
PCIE Link Speed Capability	Options available: Maximum speed, Gen1, Gen2, Gen3, Gen4, Gen5, Auto. Default setting is Auto .
RTM Margining Support	Options available: Disable, Enable, Auto. Default setting is Auto .
EQ Bypass To Highest Rate	Options available: Disable, Enable, Auto. Default setting is Auto .
nBif Common Options	Press [Enter] for configuration of advanced items.

2-3-4-1 SMU Common Options

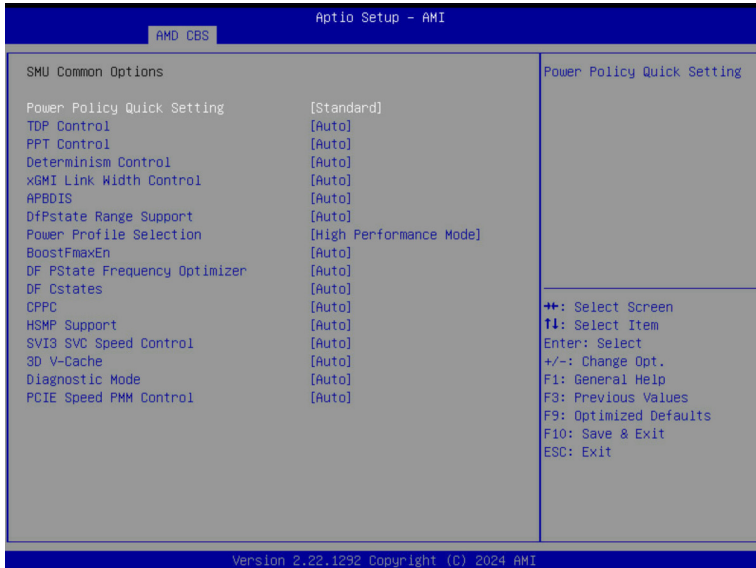

Parameter	Description
SMU Common Options	
TDP Control	Options available: Manual, Auto. Default setting is Auto .
PPT Control	Options available: Manual, Auto. Default setting is Auto .
Determinism Control	Selects use the fused Determinism or set customized Determinism. Options available: Manual, Auto. Default setting is Auto .
xGMI Link Width Control	Options available: Manual, Auto. Default setting is Auto .
APBDIS	Options available: 0, 1, Auto. Default setting is Auto .
Power Profile Selection	Options available: High Performance Mode, Efficiency Mode, Maximum IO Performance Mode. Default setting is High Performance Mode .
BoostFmaxEn	Options available: Manual, Auto. Default setting is Auto .
DF PState Frequency Optimizer	Options available: Auto, Enabled, Disabled. Default setting is Auto .
DF PState Latency Optimizer	Options available: Auto, Enabled, Disabled. Default setting is Auto .
DF Cstates	Options available: Disabled, Enabled, Auto. Default setting is Disabled .
CPPC	Enable/Disable the CPPC feature. Options available: Disabled, Enabled, Auto. Default setting is Auto .

Parameter	Description
HSMP Support	Enable/Disable the HSMP support. Options available: Disabled, Enabled, Auto. Default setting is Auto .
SVI3 SVC Speed Control	Options available: Auto, Manual. Default setting is Auto .
3D V-Cache	Options available: Auto, Disable, 1 stack, 2 stack, 4 stack. Default setting is Auto .
Diagnostic Mode	Options available: Disabled, Enabled, Auto. Default setting is Auto .
PCIe Speed PMM Control	Options available: Dynamic link speed determined by Power Management functionality, Static Target Link Speed (GEN4), Static Target Link Speed (GEN5), Auto. Default setting is Auto .
GMI Folding	Options available: Disabled, Enabled, Auto. Default setting is Auto .

2-3-4-2 NBIO RAS Common Options

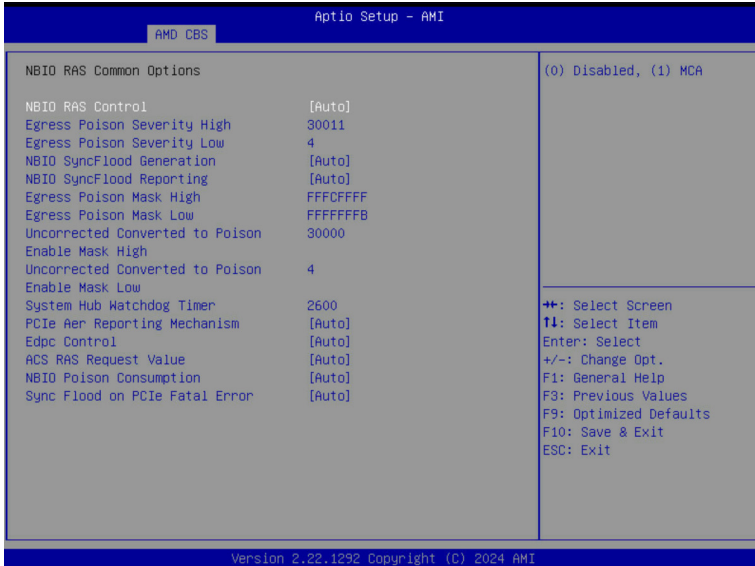

Parameter	Description
NBIO RAS Common Options	
NBIO RAS Control	Options available: Disabled, MCA, Auto. Default setting is Auto .
Egress Poison Severity High	Configures the Egress Poison High Severity. Each bit set to 1 enables High severity on the associated IOHC egress port. A bit of 0 indicates LOW severity.
Egress Poison Severity Low	Configures the Egress Poison Low Severity. Each bit set to 1 enables High severity on the associated IOHC egress port. A bit of 0 indicates LOW severity.
NBIO SyncFlood Generation	The value may be used to mask SyncFlood caused by NBIO RAS options. Options available: Enabled, Disabled, Auto. Default setting is Auto .
NBIO SyncFlood Reporting	The value may be used to enable SyncFlood reporting to APML. Options available: Enabled, Disabled, Auto. Default setting is Auto .
Egress Poison Mask High	Enables mask for masking of errors logged in EGRESS_POISON_STATUS. For each bit set to 1, errors are masked. For each bit set to 0, errors trigger response actions.
Egress Poison Mask Low	Enables mask for masking of errors logged in EGRESS_POISON_STATUS. For each bit set to 1, errors are masked. For each bit set to 0, errors trigger response actions.

Parameter	Description
Uncorrected Converted to Poison Enable Mask High	Enables mask for masking of uncorrectable parity errors on internal arrays.
Uncorrected Converted to Poison Enable Mask Low	Enables mask for masking of uncorrectable parity errors on internal arrays.
System Hub Watchdog Timer	Specifies the timer interval of the SYSHUB Watchdog timer in milliseconds.
PCIe Aer Reporting Mechanism	Selects the method of reporting AER errors from PCI Express. Options available: Firmware First, Firmware First but allow OS First, OS First, Auto. Default setting is Auto .
Edpc Control	Options available: Disabled, Enabled, Auto. Default setting is Auto .
ACS RAS Request Value	Options available: Direct Request Access Enabled, Request Blocking Enabled, Request Redirect Enabled, Auto. Default setting is Auto .
NBIO Poison Consumption	Options available: Auto, Enabled, Disabled. Default setting is Auto .
Sync Flood on PCIe Fatal Error	Options available: Auto, True, False. Default setting is Auto .

2-3-4-3 nBif Common Options

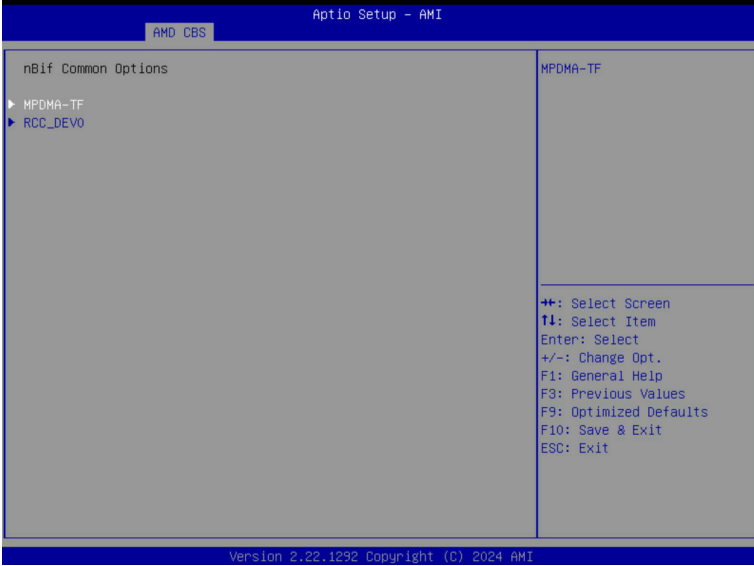

Parameter	Description
MPDMA-TF	<ul style="list-style-type: none"> ◆ SRIOV <ul style="list-style-type: none"> – Options available: Auto, Disable, Enable. Default setting is Auto. ◆ ARI <ul style="list-style-type: none"> – Options available: Auto/Default, Disable, Enable. Default setting is Auto/Default. ◆ AER <ul style="list-style-type: none"> – Options available: Auto, Disable, Enable. Default setting is Auto. ◆ ACS <ul style="list-style-type: none"> – Options available: Auto, Disable, Enable. Default setting is Auto. ◆ ATS <ul style="list-style-type: none"> – Options available: Auto, Disable, Enable. Default setting is Auto. ◆ PASID <ul style="list-style-type: none"> – Options available: Auto, Disable, Enable. Default setting is Auto. ◆ RTR <ul style="list-style-type: none"> – Options available: Auto, Disable, Enable. Default setting is Auto. ◆ PAGE_REQ <ul style="list-style-type: none"> – Options available: Auto, Disable, Enable. Default setting is Auto. ◆ PWR <ul style="list-style-type: none"> – Options available: Auto, Disable, Enable. Default setting is Auto. ◆ ATC_ENABLE <ul style="list-style-type: none"> – Options available: Auto, Disable, Enable. Default setting is Auto.

Parameter	Description
RCC_DEV0	<ul style="list-style-type: none"> ◆ ACS Rcc_Dev0 <ul style="list-style-type: none"> – Options available: Auto, Disable, Enable. Default setting is Auto.
	<ul style="list-style-type: none"> ◆ AER Rcc_Dev0 <ul style="list-style-type: none"> – Options available: Auto, Disable, Enable. Default setting is Auto.
	<ul style="list-style-type: none"> ◆ DlfEnableStrap1 <ul style="list-style-type: none"> – Options available: Auto, Disable, Enable. Default setting is Auto.
	<ul style="list-style-type: none"> ◆ Phy16GTStrap1 <ul style="list-style-type: none"> – Options available: Auto, Disable, Enable. Default setting is Auto.
	<ul style="list-style-type: none"> ◆ MarginEnStrap1 <ul style="list-style-type: none"> – Options available: Auto, Disable, Enable. Default setting is Auto.
	<ul style="list-style-type: none"> ◆ SourceValStrap5 <ul style="list-style-type: none"> – Options available: Auto, Disable, Enable. Default setting is Auto.
	<ul style="list-style-type: none"> ◆ TranslationalBlockingStrap5 <ul style="list-style-type: none"> – Options available: Auto, Disable, Enable. Default setting is Auto.
	<ul style="list-style-type: none"> ◆ P2pReq ACS Control <ul style="list-style-type: none"> – Options available: Auto, Disable, Enable. Default setting is Auto.
	<ul style="list-style-type: none"> ◆ P2pCompStrap5 <ul style="list-style-type: none"> – Options available: Auto, Disable, Enable. Default setting is Auto.
	<ul style="list-style-type: none"> ◆ UpstreamFwdStrap5 <ul style="list-style-type: none"> – Options available: Auto, Disable, Enable. Default setting is Auto.
	<ul style="list-style-type: none"> ◆ P2PEgressStrap5 <ul style="list-style-type: none"> – Options available: Auto, Disable, Enable. Default setting is Auto.
	<ul style="list-style-type: none"> ◆ DirectTranslatedStrap5 <ul style="list-style-type: none"> – Options available: Auto, Disable, Enable. Default setting is Auto.
	<ul style="list-style-type: none"> ◆ SsidEnStrap5 <ul style="list-style-type: none"> – Options available: Auto, Disable, Enable. Default setting is Auto.
	<ul style="list-style-type: none"> ◆ PriEnPageReq <ul style="list-style-type: none"> – Options available: Auto, Disable, Enable. Default setting is Auto.
	<ul style="list-style-type: none"> ◆ PriResetPageReq <ul style="list-style-type: none"> – Options available: Auto, Disable, Enable. Default setting is Auto.
	<ul style="list-style-type: none"> ◆ SourceVal ACS cntl <ul style="list-style-type: none"> – Options available: Auto, Disable, Enable. Default setting is Auto.
	<ul style="list-style-type: none"> ◆ TranslationalBlocking ACS Control <ul style="list-style-type: none"> – Options available: Auto, Disable, Enable. Default setting is Auto.
	<ul style="list-style-type: none"> ◆ P2pComp ACS Control <ul style="list-style-type: none"> – Options available: Auto, Disable, Enable. Default setting is Auto.
	<ul style="list-style-type: none"> ◆ UpstreamFwd ACS Control <ul style="list-style-type: none"> – Options available: Auto, Disable, Enable. Default setting is Auto.
	<ul style="list-style-type: none"> ◆ P2PEgress ACS Control <ul style="list-style-type: none"> – Options available: Auto, Disable, Enable. Default setting is Auto.
	<ul style="list-style-type: none"> ◆ P2pReqStrap5 <ul style="list-style-type: none"> – Options available: Auto, Disable, Enable. Default setting is Auto.
	<ul style="list-style-type: none"> ◆ E2E_PREFIX <ul style="list-style-type: none"> – Options available: Auto, Disable, Enable. Default setting is Auto.

Parameter	Description
RCC_DEV0 (continued)	♦ EXTENDED_FMT – Options available: Auto, Disable, Enable. Default setting is Auto .

2-3-5 FCH Common Options



Parameter	Description
FCH Common Options	
I3C/I2C Configuration Options	Press [Enter] for configuration of advanced items.
SATA Configuration Options	Press [Enter] for configuration of advanced items.
USB Configuration Options	Press [Enter] for configuration of advanced items.
AC Power Loss Options	Press [Enter] for configuration of advanced items.
Uart Configuration Options	Press [Enter] for configuration of advanced items.
ESPI Configuration Options	Press [Enter] for configuration of advanced items.
FCH RAS Options	Press [Enter] for configuration of advanced items.
Miscellaneous Options	Press [Enter] for configuration of advanced items.

2-3-5-1 I3C/I2C Configuration Options

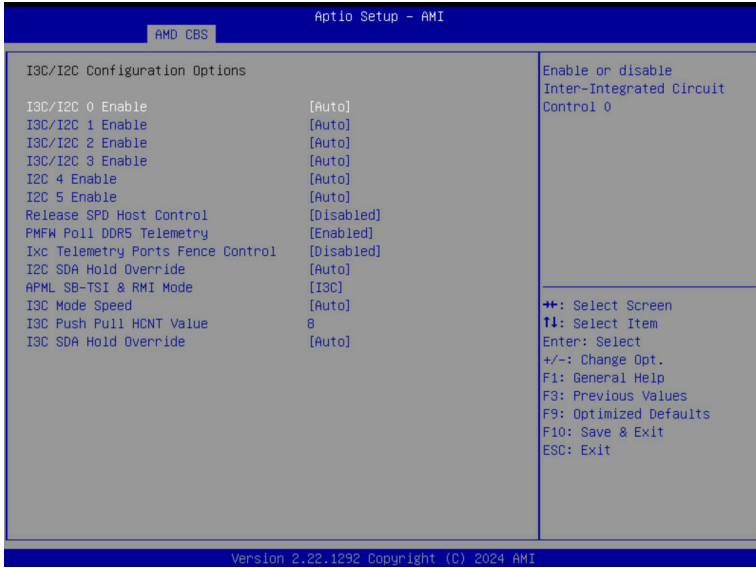

Parameter	Description
I3C/I2C Configuration Options	
I3C/I2C 0/1/2/3 Enable	Options available: Both Disabled, I3C Enabled, I2C Enabled, Auto. Default setting is Auto .
I2C 4/5 Enable	Options available: Disabled, Enabled, Auto. Default setting is Auto .
Release SPD Host Control	Options available: Disabled, Enabled, Auto. Default setting is Auto .
I2C SDA Hold Override	Options available: Disabled, Enabled, Auto. Default setting is Auto .
APLM SB-TSI Mode	Options available: I3C, I2C. Default setting is I3C .
I3C Mode Speed	Options available: SDR2(6MHz), SDR0(12.5MHz), Auto. Default setting is Auto .
I3C SDA Hold Value	Configures I3C SDA Hold value.

2-3-5-2 SATA Configuration Options

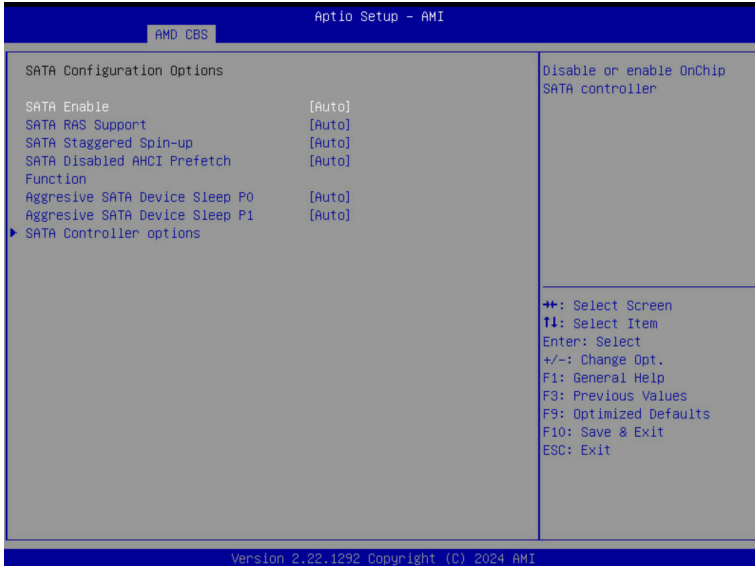

Parameter	Description
SATA Configuration Options	
SATA Enable	Enable/Disable OnChip SATA controller. Options available: Disabled, Enabled, Auto. Default setting is Auto .
SATA RAS Support	Options available: Disabled, Enabled, Auto. Default setting is Auto .
SATA Staggered Spin-up	Options available: Disabled, Enabled, Auto. Default setting is Auto .
SATA Disabled AHCI Prefetch Function	Options available: Disabled, Enabled, Auto. Default setting is Auto .
Aggressive SATA Device Sleep P0/P1	Options available: Disabled, Enabled, Auto. Default setting is Auto .
SATA Controller options	Press [Enter] for configuration of advanced items. <ul style="list-style-type: none"> ◆ SATA Controller Enable ◆ SATA Controller eSATA ◆ SATA Controller DevSlp ◆ SATA Controller SGPIO

2-3-5-3 USB Configuration Options

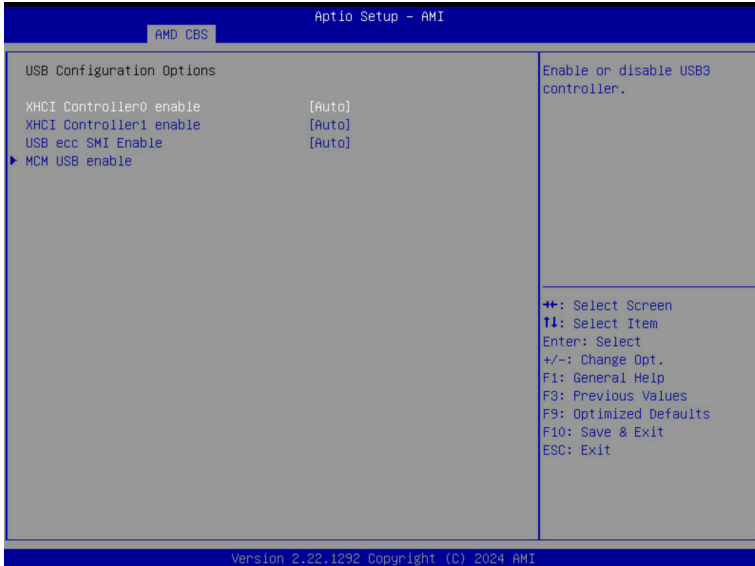

Parameter	Description
USB Configuration Options	
XHCI Controller0/1 enable	Enable/Disable USB controller. Options available: Enabled, Disabled, Auto. Default setting is Auto .
USB ecc SMI Enable	Options available: Enable, Off, Auto. Default setting is Auto .
MCM USB enable	Press [Enter] for configuration of advanced items. <ul style="list-style-type: none"> ◆ XHCI2/ XHCI3 enable (Socket1) <ul style="list-style-type: none"> – Options available: Enabled, Disabled, Auto. Default setting is Auto.

2-3-5-4 AC Power Loss Options

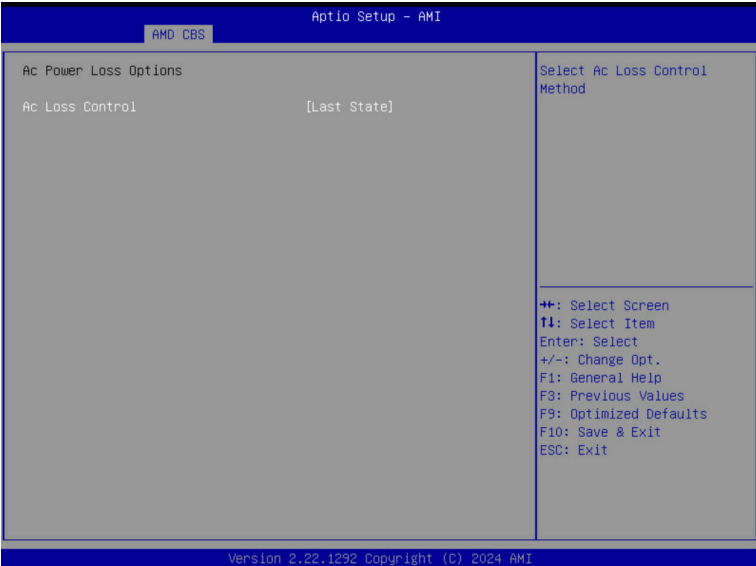

Parameter	Description
AC Power Loss Options	
AC Loss Control	Selects the AC Loss Control Method. Options available: Power Off, Power On, Last State. Default setting is Last State .

2-3-5-5 Uart Configuration Options

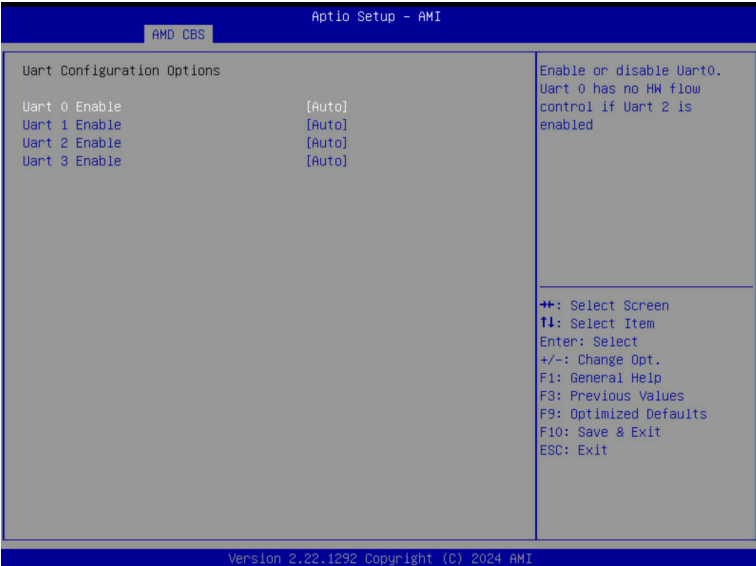

Parameter	Description
Uart Configuration Options	
Uart 0/1/2/3 Enable	Options available: Disabled, Enabled, Auto. Default setting is Auto .

2-3-5-6 ESPI Configuration Options

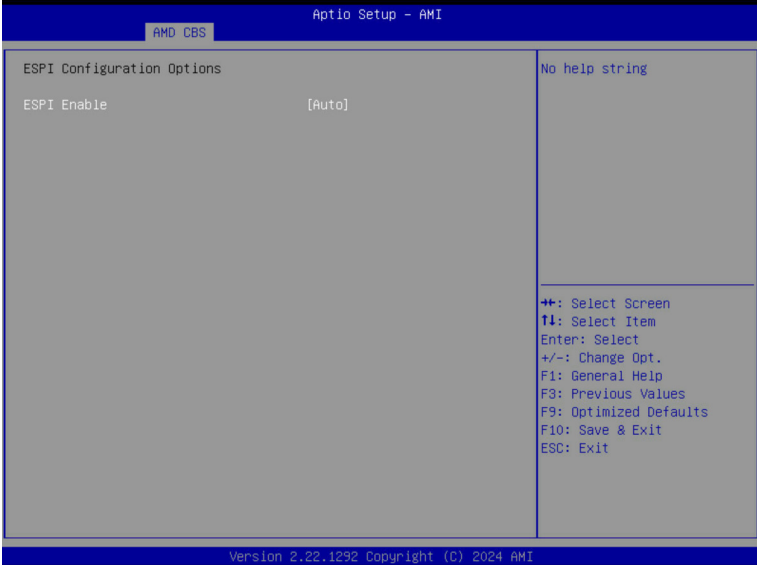

Parameter	Description
ESPI Configuration Options	
ESPI Enable	Options available: Disabled, Enabled, Auto. Default setting is Auto .

2-3-5-7 FCH RAS Options

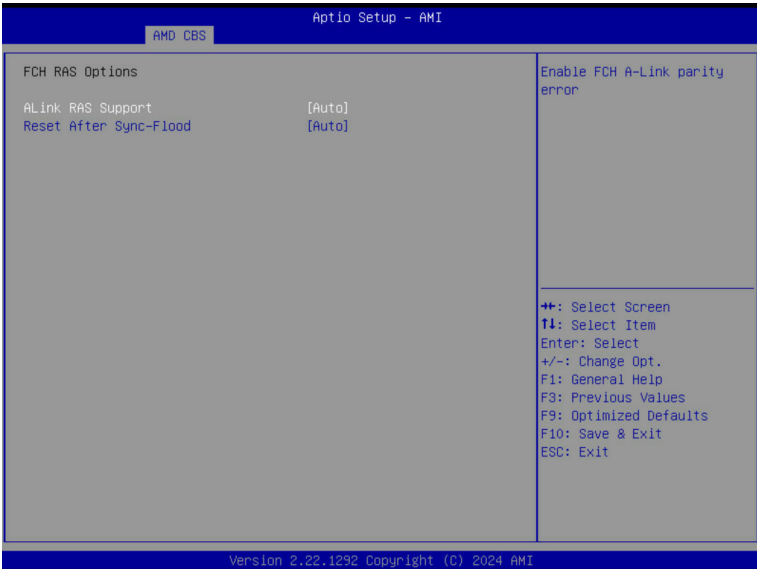

Parameter	Description
FCH RAS Options	
ALink RAS Support	Enable/Disable the ALink RAS Support. Options available: Disabled, Enabled, Auto. Default setting is Auto .
Reset after sync flood	Enables AB to forward downstream sync-flood message to system controller. Options available: Enable, Disable, Auto. Default setting is Auto .

2-3-5-8 Miscellaneous Options

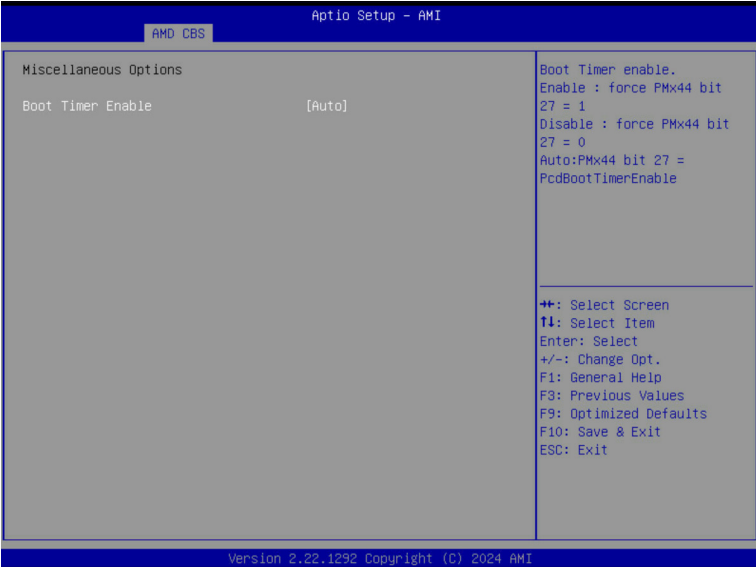

Parameter	Description
Miscellaneous Options	
Boot Timer Enable	Enable/Disable Boot Timer. Options available: Disabled, Enabled, Auto. Default setting is Auto .

2-3-6 SOC Miscellaneous Control

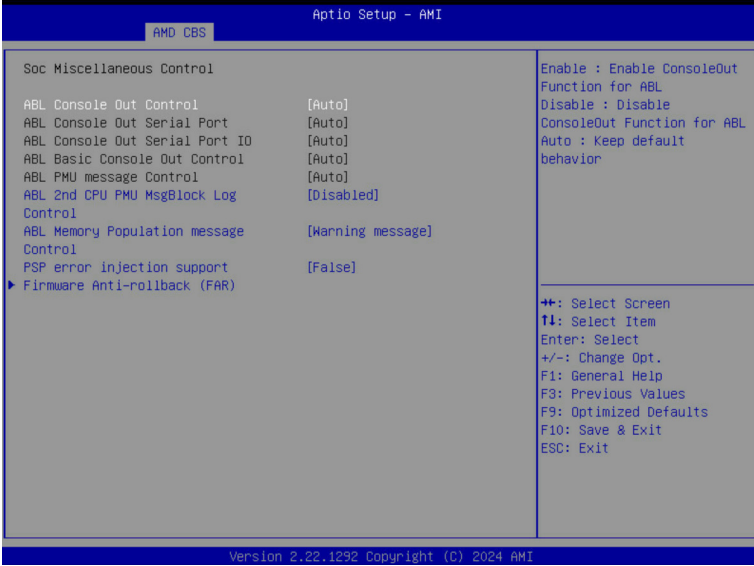

Parameter	Description
SOC Miscellaneous Control	
ABL Console Out Control ^(Note)	Enable/Disable the ConsoleOut function for ABL. Options available: Disable, Enable, Auto. Default setting is Auto .
ABL Console Out Serial Port ^(Note)	Options available: eSPI, SOC UART0, SOC UART1, Auto. Default setting is Auto .
ABL Console Out Serial Port IO	Options available: 0x3F8, 0x2F8, 0x3E8, 0x2E8, Auto. Default setting is Auto .
ABL Basic Console Out Control	Enable/Disable the Basic ConsoleOut function for ABL. Options available: Disable, Enable, Auto. Default setting is Auto .
ABL PMU message Control	To Control the total number of PMU debug messages. Options available: Auto, Detailed debug message, Coarse debug message, Stage completion, Assertion messages, Firmware completion message only. Default setting is Auto .
ABL Memory Population message Control	Options available: Warning message, Fatal error. Default setting is Warning message .
PSP error injection support	Options available: False, True. Default setting is False .

(Note) Advanced items are configurable when this item is defined.

Parameter	Description
Firmware Anti-rollback (FAR)	<p data-bbox="366 161 753 183">Press [Enter] for configuration of advanced items.</p> <ul data-bbox="366 189 942 357" style="list-style-type: none"><li data-bbox="366 189 628 241">◆ FAR enforcement state<ul data-bbox="402 221 628 241" style="list-style-type: none"><li data-bbox="402 221 628 241">– Default setting is Enabled.<li data-bbox="366 247 618 269">◆ SPL value in the CPU Fuse<li data-bbox="366 275 612 297">◆ SPL value in the SPL table<li data-bbox="366 304 495 326">◆ FAR Switch<ul data-bbox="402 335 942 357" style="list-style-type: none"><li data-bbox="402 335 942 357">– Options available: Disabled, Enabled, Auto. Default setting is Auto.

(Note) Advanced items are configurable when this item is defined.

2-3-7 CXL Common Options

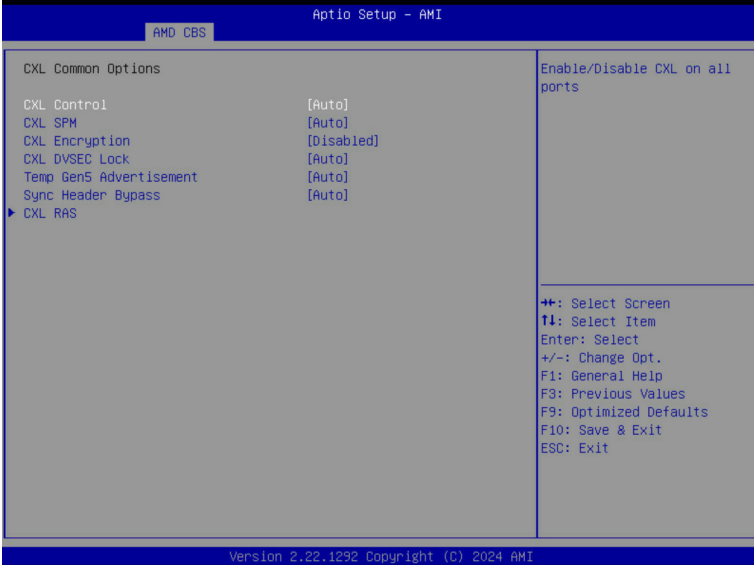

Parameter	Description
CXL Control	Options available: Auto, Enabled, Disabled. Default setting is Auto .
CXL SPM	Options available: Auto, Enabled, Disabled. Default setting is Auto .
CXL ASPM	Options available: Auto, Enabled, Disabled. Default setting is Auto .
CXL vLSM Power Management	<p>Press [Enter] for configuration of advanced items.</p> <ul style="list-style-type: none"> ◆ CXL.io <ul style="list-style-type: none"> - L1/L2 <ul style="list-style-type: none"> • Options available: Auto, Enabled, Disabled. Default setting is Auto. ◆ CXL.camem <ul style="list-style-type: none"> - L1/L2 <ul style="list-style-type: none"> • Options available: Auto, Enabled, Disabled. Default setting is Auto.
CXL Encryption	Options available: Enabled, Disabled. Default setting is Disabled .
Temp Gen5 Advertisement	Options available: Disable, Enable, Auto. Default setting is Auto .
Sync Header Bypass	Options available: Auto, Enabled, Disabled. Default setting is Auto .
CXL RAS	<p>Press [Enter] for configuration of advanced items.</p> <ul style="list-style-type: none"> ◆ CXL Protocol Error Reporting <ul style="list-style-type: none"> - Options available: Disabled, SameAsPcieAer, ForceAerFwFirstIfCxlPresent. Default setting is SameAsPcieAer. ◆ CXL Component Error Reporting <ul style="list-style-type: none"> - Options available: OS First, FW-First. Default setting is FW-First.

2-4 AMD PBS Menu

AMD PBS Option menu displays submenu options for configuring the function of AMD PBS. Select a submenu item, then press [Enter] to access the related submenu screen.

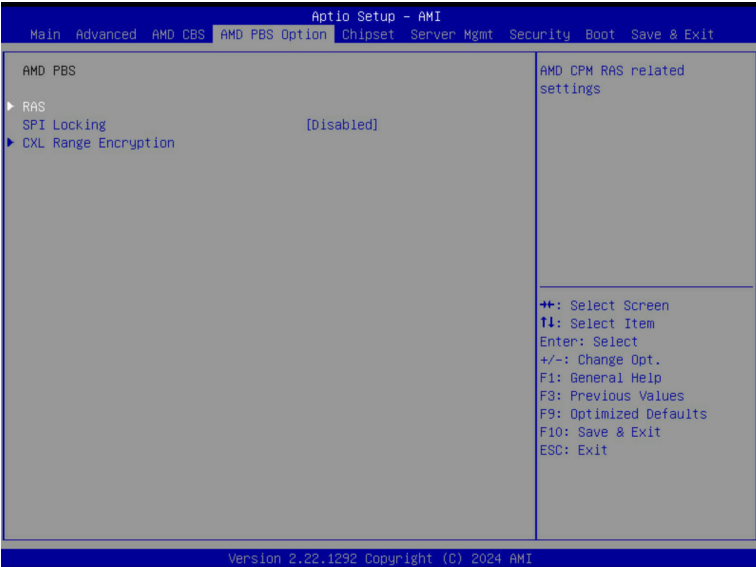

Parameter	Description
RAS	Press [Enter] for configuration of advanced items.
SPI Locking	Enable/Disable SPI Locking for protect ROM part. Options available: Disabled, Enabled. Default setting is Disabled .

2-4-1 RAS



Parameter	Description
RAS Periodic SMI Control	Enable/Disable the Periodic SMI for polling [MCA Threshold] error. Options available: Disabled, Enabled. Default setting is Enabled .
SMI Threshold	Configures the SMI Threshold value.
SMI Scale	Configures the SMI Scale value.
SMI Scale Unit	Defines the unit of time scale. Options available: millisecond, second, minute. Default setting is millisecond .
SMI Period	Configures the SMI Period.
GHEs Notify Type	Selects the Notification type for deferred/ corrected errors. Options available: Polled, SCI. Default setting is Polled .
GHEs UnCorr Notify Type	Selects the Notification type for uncorrected errors. Options available: Polled, NMI. Default setting is NMI .
PCIe GHEs Notify Type	Selects the Notification type for PCIe corrected errors. Options available: Polled, SCI. Default setting is Polled .
PCIe UnCorr GHEs Notify Type	Selects the Notification type for PCIe uncorrected errors. Options available: Polled, NMI. Default setting is NMI .
PCIe Root Port Corr Err Mask Reg	Initialize the PCIe AER Corrected Error Mask register of Root Port.

Parameter	Description
PCIe Root Port UnCorr Err Mask Reg	Initialize the PCIe AER Uncorrected Error Mask register of Root Port.
PCIe Root Port UnCorr Err Sev Reg	Initialize the PCIe AER Uncorrected Error Severity register of Root Port.
PCIe Device Corr Err Mask Reg	Initialize the PCIe AER Corrected Error Mask register of PCIe device.
PCIe Device UnCorr Err Mask Reg	Initialize the PCIe AER Uncorrected Error Mask register of PCIe device.
PCIe Device UnCorr Err Sev Reg	Initialize the PCIe AER Uncorrected Error Severity register of PCIe device.
DRAM Hard Post Package Repair	This feature allows spare DRAM rows to replace malfunctioning rows via an in-field repair mechanism. Options available: Disabled, Enabled. Default setting is Disabled .
HEST DMC Structure Support	HEST DMC (Deferred Machine Check) Structure Support. Options available: Disabled, Enabled. Default setting is Disabled .
CXL Error Report Support	Enable/Disable CXL Error Reporting. Options available: Disabled, Enabled. Default setting is Disabled .

2-5 Chipset Setup Menu

Chipset Setup menu displays submenu options for configuring the function of the North Bridge. Select a submenu item, then press <Enter> to access the related submenu screen.

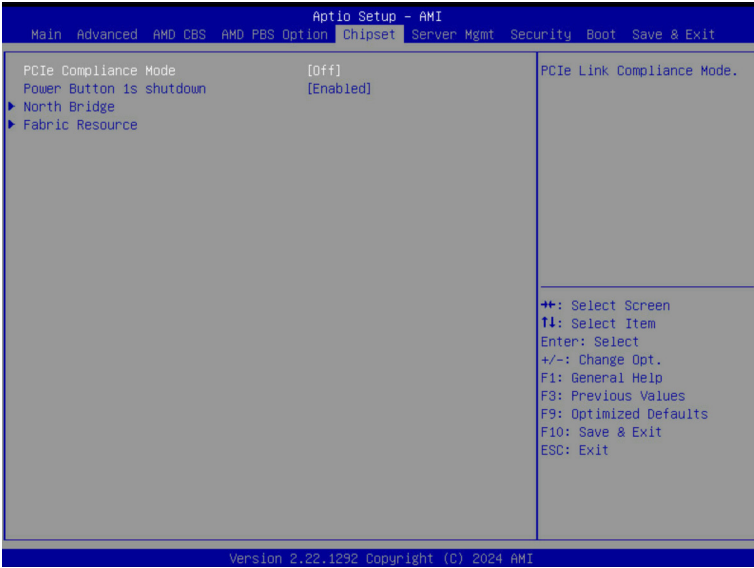

Parameter	Description
PCIe Link Training Type	Options available: 1 Step, 2 Step. Default setting is 1 Step .
PCIe Compliance Mode	Options available: Off, On. Default setting is Off .
Program All VR	Enable/Disable program all VR on MB. Options available: Disabled, Enabled. Default setting is Enabled .
North Bridge	Press [Enter] for configuration of advanced items.
Fabric Resource	Press [Enter] for configuration of advanced items.

2-5-1 North Bridge

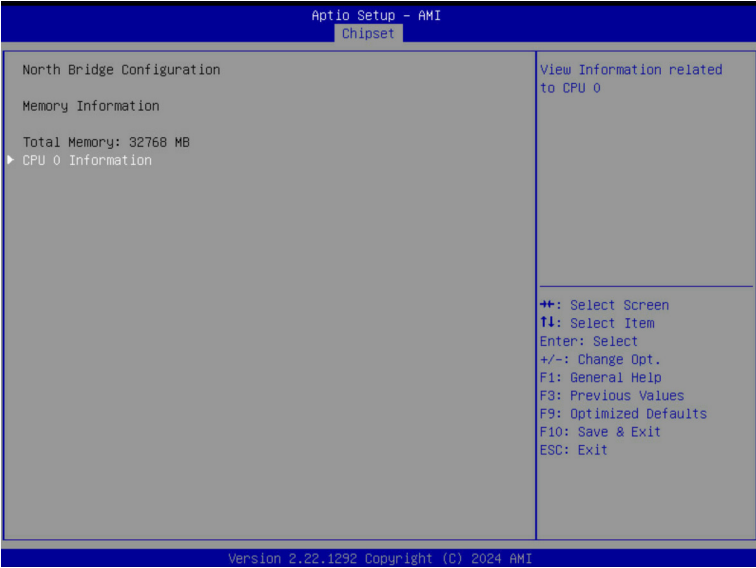

Parameter	Description
North Bridge Configuration	
Memory Information	
Total Memory	Displays the total memory information.
CPU 0 Information	Press [Enter] to view information related to CPU 0.

2-5-2 Fabric Resource

Aptio Setup - AMI
Chipset

Fabric Resource

CPU0 NBIO0:
Base Bus: 0xC0
Prefetchable Mmio Above 4G Size: 2048 GB
IO Resource: 0x0
PCIe Bus Number: 40
Prefetchable Mmio Above 4G size: [System Default]
PCIe IO Resource: FFFF

CPU0 NBIO1:
Base Bus: 0x80
Prefetchable Mmio Above 4G Size: 2048 GB
IO Resource: 0x0
PCIe Bus Number: 40
Prefetchable Mmio Above 4G size: [System Default]
PCIe IO Resource: FFFF

CPU0 NBIO2:
Base Bus: 0x00
Prefetchable Mmio Above 4G Size: 2048 GB
IO Resource: 0x0
PCIe Bus Number: 40
Prefetchable Mmio Above 4G size: [System Default]
PCIe IO Resource: FFFF

Change CPU0 NBIO0 PCIe bus number

+*: Select Screen
↑↓: Select Item
Enter: Select
+/-: Change Opt.
F1: General Help
F3: Previous Values
F9: Optimized Defaults
F10: Save & Exit
ESC: Exit

Version 2.22.1292 Copyright (C) 2024 AMI

Aptio Setup - AMI
Chipset

CPU0 NBIO1:
Base Bus: 0x80
Prefetchable Mmio Above 4G Size: 2048 GB
IO Resource: 0x0
PCIe Bus Number: 40
Prefetchable Mmio Above 4G size: [System Default]
PCIe IO Resource: FFFF

CPU0 NBIO2:
Base Bus: 0x00
Prefetchable Mmio Above 4G Size: 2048 GB
IO Resource: 0x0
PCIe Bus Number: 40
Prefetchable Mmio Above 4G size: [System Default]
PCIe IO Resource: FFFF

CPU0 NBIO3:
Base Bus: 0x40
Prefetchable Mmio Above 4G Size: 2048 GB
IO Resource: 0x0
PCIe Bus Number: 40
Prefetchable Mmio Above 4G size: [System Default]
PCIe IO Resource: FFFF

Change CPU0 NBIO3 PCIe IO Resource

+*: Select Screen
↑↓: Select Item
Enter: Select
+/-: Change Opt.
F1: General Help
F3: Previous Values
F9: Optimized Defaults
F10: Save & Exit
ESC: Exit

Version 2.22.1292 Copyright (C) 2024 AMI

Parameter	Description
Fabric Resource	
CPU 0 NBIO_# PCIe Bus Number	Change CPU 0/1 NBIO_# PCIe Bus Number.
Prefetchable Mmio Above 4G size	Change CPU 0/1 NBIO_# Prefetchable MMIO Above 4G Size. Options available: System Default, 0, 1G, 2G, 4G, 8G, 16G, 32G, 64G, 128G, 256G, 512G, 1T, 2T, 4T, 8T. Default setting is System Default .
PCIe IO Resource	Change CPU 0/1 NBIO_# PCIe IO Resource.

2-6 Server Management Menu

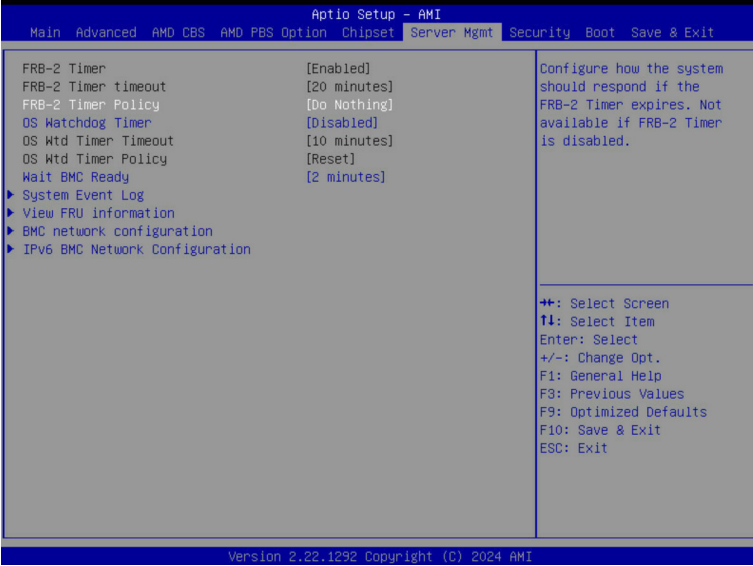

Parameter	Description
FRB-2 Timer	Enable/Disable FRB-2 timer (POST timer). Default setting is Enabled .
FRB-2 Timer timeout	Configures the FRB2 Timer timeout. Options available: 3 minutes, 4 minutes, 5 minutes, 6 minutes. Default setting is 6 minutes .
FRB-2 Timer Policy	Configures the FRB2 Timer policy. Options available: Do Nothing, Reset, Power Down, Power Cycle. Default setting is Do Nothing .
OS Watchdog Timer	Enable/Disable OS Watchdog Timer function. Options available: Enabled, Disabled. Default setting is Disabled .
OS Wtd Timer Timeout ^(Note)	Configures OS Watchdog Timer. Options available: 5 minutes, 10 minutes, 15 minutes, 20 minutes. Default setting is 10 minutes .
OS Wtd Timer Policy ^(Note)	Configure OS Watchdog Timer Policy. Options available: Do Nothing, Reset, Power Down, Power Cycle. Default setting is Reset .
Wait BMC Ready	Post wait BMC ready and reboot system. Options available: Disabled, 2 minutes, 4 minutes, 6 minutes. Default setting is 2 minutes .

(Note) This item is configurable when **OS Watchdog Timer** is set to **Enabled**.

Parameter	Description
System Event Log	Press [Enter] to configure advanced items.
View FRU Information	Press [Enter] to view the FRU information.
BMC network configuration	Press [Enter] to configure advanced items.
IPv6 BMC Network Configuration	Press [Enter] to configure advanced items.

2-6-1 System Event Log

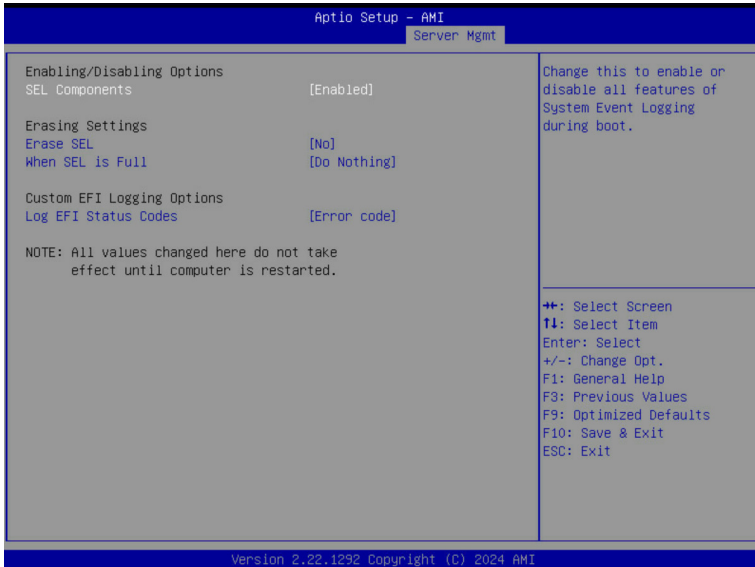

Parameter	Description
Enabling / Disabling Options	
SEL Components	Change this item to enable or disable all features of System Event Logging during boot. Options available: Disabled, Enabled. Default setting is Enabled .
Erasing Settings	
Erase SEL	Choose options for erasing SEL. Options available: No/Yes, On next reset/Yes, On every reset. Default setting is No .
When SEL is Full	Choose options for reactions to a full SEL. Options available: Do Nothing, Erase Immediately. Default setting is Do Nothing .
Custom EFI Logging Options	
Log EFI Status Codes	Enable/Disable the logging of EFI Status Codes (if not already converted to legacy). Options available: Disabled, Both, Error code, Progress code. Default setting is Error code .

2-6-2 View FRU Information

The FRU page is a simple display page for basic system ID information, as well as System product information. Items on this window are non-configurable.

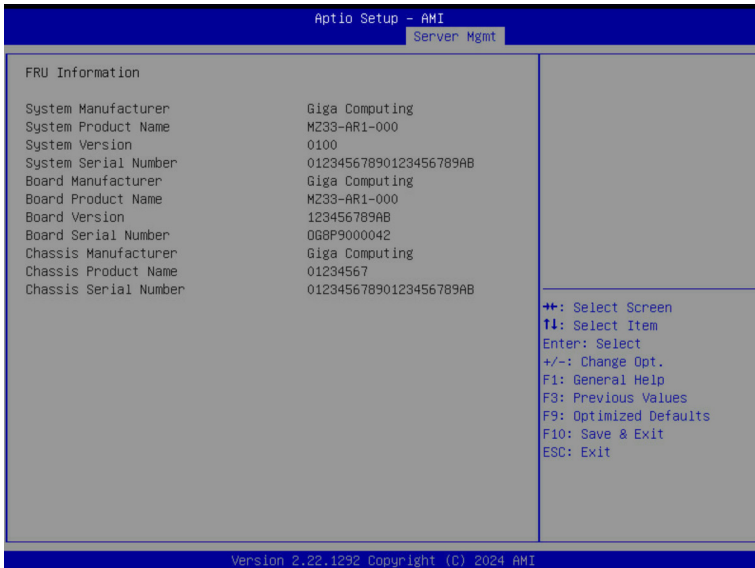

(Note) The model name will vary depends on the product you purchased

2-6-3 BMC Network Configuration

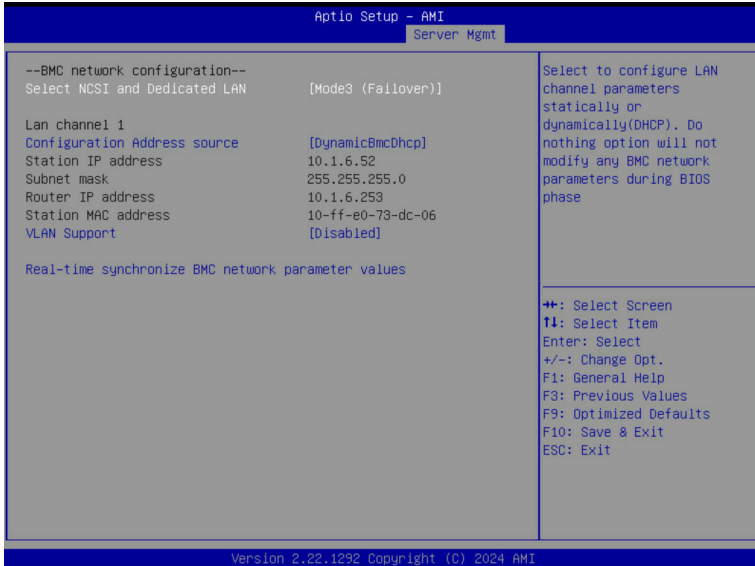

Parameter	Description
BMC network configuration	
Lan Channel 1	
Configuration Address source	Selects to configure LAN channel parameters statically or dynamically (DHCP). Do nothing option will not modify any BMC network parameters during BIOS phase. Options available: Unspecified, Static, DynamicBmcDhcp. Default setting is DynamicBmcDhcp .
Station IP address	Displays IP Address information.
Subnet mask	Displays Subnet Mask information. Please note that the IP address must be in three digitals, for example, 192.168.000.001.
Router IP address	Displays the Router IP Address information.
Station MAC address	Displays the MAC Address information.
VLAN Support	Set BMC to enable/disable VLAN support. Options available: Enabled, Disabled. Default setting is Disabled .
Real-time synchronize BMC network parameter values	Press [Enter] will set Address source(Static/DHCP) to BMC and then get Station IP address, Subnet mask and Router IP address from BMC.

2-6-4 IPv6 BMC Network Configuration

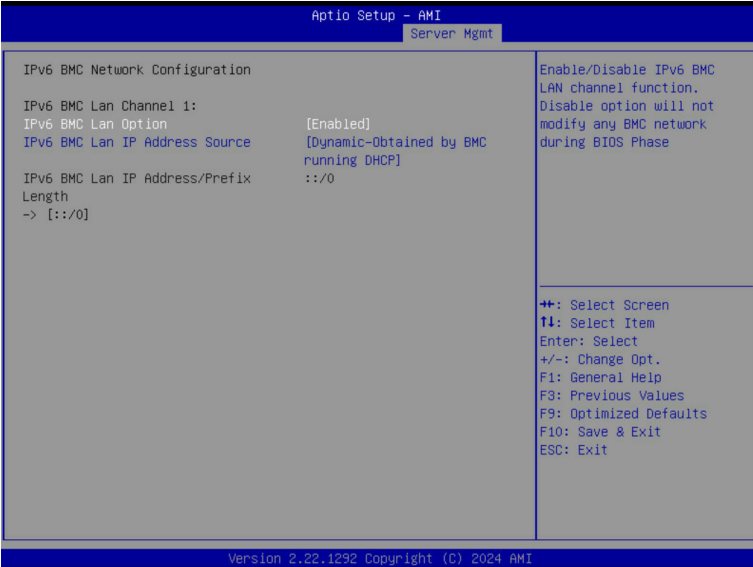

Parameter	Description
IPv6 BMC network configuration	
IPv6 BMC Lan Channel 1	
IPv6 BMC Lan Option	Enable/Disable IPv6 BMC LAN channel function. When this item is disabled, the system will not modify any BMC network during BIOS phase. Options available: Unspecified, Disable, Enable. Default setting is Enable .
IPv6 BMC Lan IP Address Source	Selects to configure LAN channel parameters statically or dynamically (by BIOS or BMC). Options available: Unspecified, Static, Dynamic-Obtained by BMC running DHCP. Default setting is Dynamic-Obtained by BMC running DHCP .
IPv6 BMC Lan IP Address/Prefix Length	Check if the IPv6 BMC LAN IP address matches those displayed on the screen.

2-7 Security Menu

The Security menu allows you to safeguard and protect the system from unauthorized use by setting up access passwords.

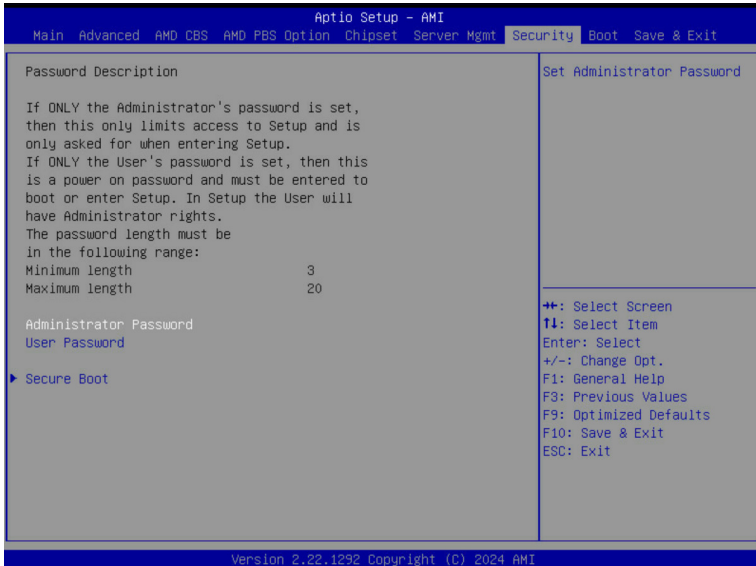

There are two types of passwords that you can set:

- Administrator Password
Entering this password will allow the user to access and change all settings in the Setup Utility.
- User Password
Entering this password will restrict a user's access to the Setup menus. To enable or disable this field, a Administrator Password must first be set. A user can only access and modify the System Time, System Date, and Set User Password fields.

Parameter	Description
Administrator Password	Press [Enter] to configure the administrator password.
User Password	Press [Enter] to configure the user password.
Secure Boot	Press [Enter] to configure advanced items.

2-7-1 Secure Boot

The Secure Boot submenu is applicable when your device is installed the Windows® 8 (or above) operating system.



Parameter	Description
System Mode	Displays if the system is in User mode or Setup mode.
Secure Boot	Enable/ Disable the Secure Boot function. Options available: Enabled, Disabled. Default setting is Disabled .
Secure Boot Mode ^(Note)	Secure Boot requires all the applications that are running during the booting process to be pre-signed with valid digital certificates. This way, the system knows all files being loaded before Windows loads to the login screen have not been tampered with. When set to Standard, it will automatically load the Secure Boot keys from the BIOS databases. When set to Custom, you can customize the Secure Boot settings and manually load its keys from the BIOS database. Options available: Standard, Custom. Default setting is Standard .
Restore Factory Keys	Forces the system to user mode and installs factory default Secure Boot key database.
Reset To Setup Mode	Press [Enter] to reset the system mode to Setup mode.
Enter Audit Mode	Press [Enter] to set the system mode to audit mode.

(Note) Advanced items prompt when this item is set to **Custom**.

Parameter	Description
Key Management	<p data-bbox="334 158 666 180">Press [Enter] to configure advanced items.</p> <p data-bbox="334 186 937 236">Please note that this item is configurable when Secure Boot Mode is set to Custom.</p> <ul style="list-style-type: none"> <li data-bbox="334 243 944 349">◆ Factory Key Provision <ul style="list-style-type: none"> <li data-bbox="370 271 944 321">– Allows to provision factory default Secure Boot keys when system is in Setup Mode. <li data-bbox="370 327 905 349">– Options available: Enabled, Disabled. Default setting is Disabled. <li data-bbox="334 355 926 431">◆ Restore Factory Keys <ul style="list-style-type: none"> <li data-bbox="370 384 926 406">– Installs all factory default keys. It will force the system in User Mode. <li data-bbox="370 412 605 431">– Options available: Yes, No. <li data-bbox="334 437 902 512">◆ Enroll Efi Image <ul style="list-style-type: none"> <li data-bbox="370 465 902 512">– Press [Enter] to enroll SHA256 hash of the binary into Authorized Signature Database (db). <li data-bbox="334 519 898 569">◆ Secure Boot variable <ul style="list-style-type: none"> <li data-bbox="370 550 898 569">– Displays the current status of the variables used for secure boot. <li data-bbox="334 575 802 682">◆ Platform Key (PK) <ul style="list-style-type: none"> <li data-bbox="370 603 802 625">– Displays the current status of the Platform Key (PK). <li data-bbox="370 631 678 653">– Press [Enter] to configure a new PK. <li data-bbox="370 660 602 682">– Options available: Update. <li data-bbox="334 688 942 823">◆ Key Exchange Keys (KEK) <ul style="list-style-type: none"> <li data-bbox="370 716 942 738">– Displays the current status of the Key Exchange Key Database (KEK). <li data-bbox="370 744 905 794">– Press [Enter] to configure a new KEK or load additional KEK from storage devices. <li data-bbox="370 801 671 823">– Options available: Update, Append. <li data-bbox="334 829 948 964">◆ Authorized Signatures (DB) <ul style="list-style-type: none"> <li data-bbox="370 857 905 879">– Displays the current status of the Authorized Signature Database. <li data-bbox="370 885 948 936">– Press [Enter] to configure a new DB or load additional DB from storage devices. <li data-bbox="370 942 671 964">– Options available: Update, Append. <li data-bbox="334 970 902 1105">◆ Forbidden Signatures (DBX) <ul style="list-style-type: none"> <li data-bbox="370 998 902 1020">– Displays the current status of the Forbidden Signature Database. <li data-bbox="370 1027 892 1077">– Press [Enter] to configure a new dbx or load additional dbx from storage devices. <li data-bbox="370 1083 671 1105">– Options available: Update, Append. <li data-bbox="334 1111 929 1246">◆ Authorized TimeStamps (DBT) <ul style="list-style-type: none"> <li data-bbox="370 1139 929 1161">– Displays the current status of the Authorized TimeStamps Database. <li data-bbox="370 1168 905 1218">– Press [Enter] to configure a new DBT or load additional DBT from storage devices. <li data-bbox="370 1224 671 1246">– Options available: Update, Append. <li data-bbox="334 1252 919 1381">◆ OsRecovery Signatures <ul style="list-style-type: none"> <li data-bbox="370 1281 919 1303">– Displays the current status of the OsRecovery Signature Database. <li data-bbox="370 1309 887 1359">– Press [Enter] to configure a new OsRecovery Signature or load additional OsRecovery Signature from storage devices. <li data-bbox="370 1365 671 1381">– Options available: Update, Append.

2-8 Boot Menu

The Boot menu allows you to set the drive priority during system boot-up. BIOS setup will display an error message if the legacy drive(s) specified is not bootable.

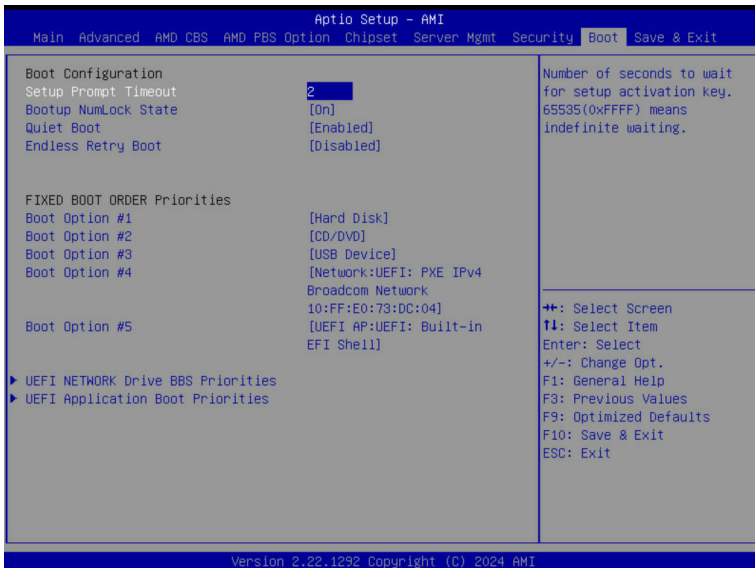

Parameter	Description
Boot Configuration	
Setup Prompt Timeout	Number of seconds to wait for setup activation key. 65535 (0xFFFF) means indefinite waiting. Press the numeric keys to input the desired values.
Bootup NumLock State	Enable/Disable the Bootup NumLock function. Options available: On, Off. Default setting is On .
Quiet Boot	Enable/Disable showing the logo during POST. Options available: Enabled, Disabled. Default setting is Enabled .
Setup Flash	Press [Enter] to run setup flash.
Dump full Setup Data	Press [Enter] to dump full setup data to file.
Dump non-default Setup Data	Press [Enter] to dump non-default setup data to file.
Restore Setup Data	Press [Enter] to restore setup data from file (cJson format).
Boot mode select	Selects the boot mode. Options available: LEGACY, UEFI. Default setting is UEFI .

Parameter	Description
FIXED BOOT ORDER Priorities	
Boot Option #1 / #2 / #3 / #4 / #5	<p>Press [Enter] to configure the boot priority. By default, the server searches for boot devices in the following sequence:</p> <ol style="list-style-type: none"> 1. Hard drive. 2. CD-COM/DVD drive. 3. USB device. 4. Network. 5. UEFI.
UEFI Network Drive BBS Priorities	Press [Enter] to configure the boot priority.
UEFI Application Boot Priorities	Press [Enter] to configure the boot priority.

2-9 Save & Exit Menu

The Save & Exit menu displays the various options to quit from the BIOS setup. Highlight any of the exit options then press <Enter>.

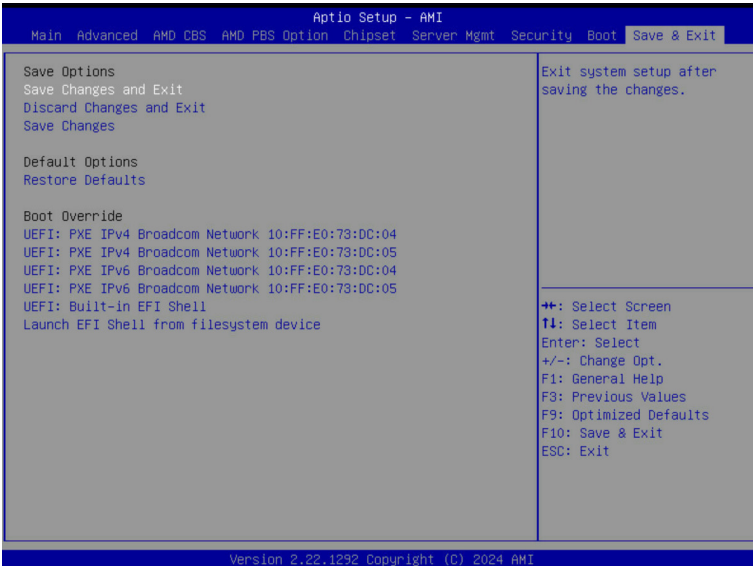

Parameter	Description
Save Options	
Save Changes and Exit	Saves changes made and closes the BIOS setup. Options available: Yes, No.
Discard Changes and Exit	Discards changes made and exits the BIOS setup. Options available: Yes, No.
Save Changes	Saves changes done so far to any of the setup options. Options available: Yes, No.
Default Options	
Restore Defaults	Loads the default settings for all BIOS setup parameters. Setup Defaults are quite demanding in terms of resources consumption. If you are using low-speed memory chips or other kinds of low-performance components and you choose to load these settings, the system might not function properly. Options available: Yes, No.
Boot Override	Press [Enter] to configure the device as the boot-up drive.
Launch EFI Shell from filesystem device	Attempts to Launch EFI Shell application (Shell.efi) from one of the available file system devices.

2-10 BIOS Recovery

The system has an embedded recovery technique. In the event that the BIOS becomes corrupt the boot block can be used to restore the BIOS to a working state. To restore your BIOS, please follow the instructions listed below:

Recovery Instruction:

1. Copy the XXX.rom to USB diskette.
2. Setting BIOS Recovery jump to enabled status.
3. Boot into BIOS recovery.
4. Run Proceed with flash update.
5. BIOS updated.

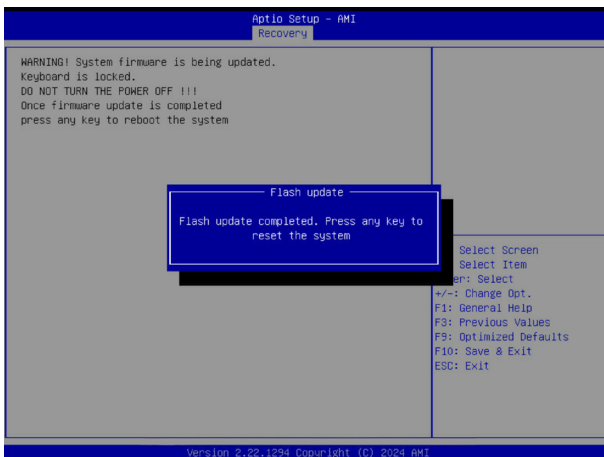

2-11 BIOS POST Beep code (AMI standard)

2-11-1 PEI Beep Codes

# of Beeps	Description
1	Memory not Installed.
1	Memory was installed twice (InstallPeiMemory routine in PEI Core called twice)
2	Recovery started
3	DXE IPL was not found
3	DXE Core Firmware Volume was not found
4	Recovery failed
4	S3 Resume failed
7	Reset PPI is not available

2-11-2 DXE Beep Codes

# of Beeps	Description
1	Invalid password
4	Some of the Architectural Protocols are not available
5	No Console Output Devices are found
5	No Console Input Devices are found
6	Flash update is failed
7	Reset protocol is not available
8	Platform PCI resource requirements cannot be met