

# **GIGABYTE™**

# **R264-S30-AAV1**

Rack Server - Intel® Xeon® 6 Processors  
2U UP 12-Bay Gen5 NVMe/SATA/SAS-4 (12 x NVMe)

## **User Manual**

Rev. 1.0

## **Copyright**

© 2024 Giga Computing Technology CO., LTD. All rights reserved.

The trademarks mentioned in this manual are legally registered to their respective owners.

## **Disclaimer**

Information in this manual is protected by copyright laws and is the property of Giga Computing. Changes to the specifications and features in this manual may be made by Giga Computing without prior notice. No part of this manual may be reproduced, copied, translated, transmitted, or published in any form or by any means without Giga Computing's prior written permission.

## **Documentation Classifications**

In order to assist in the use of this product, Giga Computing provides the following types of documentation:

- User Manual: detailed information & steps about the installation, configuration and use of this product (e.g. motherboard, server barebones), covering hardware and BIOS.
- User Guide: detailed information about the installation & use of an add-on hardware or software component (e.g. BMC firmware, rail-kit) compatible with this product.
- Quick Installation Guide: a short guide with visual diagrams that you can reference easily for installation purposes of this product (e.g. motherboard, server barebones).

Please see the support section of the online product page to check the current availability of these documents.

## **For More Information**

For related product specifications, the latest firmware and software, and other information please visit our website at <http://www.gigabyte.com/Enterprise>

For GIGABYTE distributors and resellers, additional sales & marketing materials are available from our reseller portal: <http://reseller.b2b.gigabyte.com>

For further technical assistance, please contact your GIGABYTE representative or visit <https://support.gigabyte.com/> to create a new support ticket

For any general sales or marketing enquiries, you may also message GIGABYTE server directly by email: [server.grp@gigabyte.com](mailto:server.grp@gigabyte.com)

## Conventions

The following conventions are used in this user's guide:

|   |   |
|---|---|
|  | <b>NOTE!</b><br>Gives bits and pieces of additional information related to the current topic.           |
|  | <b>CAUTION!</b><br>Gives precautionary measures to avoid possible hardware or software problems.        |
|  | <b>WARNING!</b><br>Alerts you to any damage that might result from doing or not doing specific actions. |

## Server Warnings and Cautions

Before installing a server, be sure that you understand the following warnings and cautions.



### WARNING!

**To reduce the risk of electric shock or damage to the equipment:**

- Do not disable the power cord grounding plug. The grounding plug is an important safety feature.
- Plug the power cord into a grounded (earthed) electrical outlet that is easily accessible at all times.
- Unplug all the power cords from the power supplies to disconnect power to the equipment.

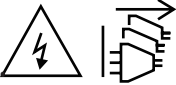

- Shock Hazard! Disconnect all power supply cords before servicing.
- Do not route the power cord where it can be walked on or pinched by items placed against it. Pay particular attention to the plug, electrical outlet, and the point where the cord extends from the server.



### WARNING!

**To reduce the risk of personal injury from hot surfaces, allow the drives and the internal system components to cool before touching them.**



### WARNING!

**This server is equipped with high speed fans. Keep away from hazardous moving fan blades during servicing.**



### WARNING!

**This equipment is intended to be used in Restricted Access Area. The access can only be gained by Skilled person. Only authorized by well trained professional person can access the restrict access location.**



### WARNING!

**The equipment should only be repaired, maintained or replaced by skilled personnel.**



### CAUTION!

- Do not operate the server for long periods with the access panel open or removed. Operating the server in this manner results in improper airflow and improper cooling that can lead to thermal damage.
- Danger of explosion if battery is incorrectly replaced.
- Replace only with the same or equivalent type recommended by the manufacturer.
- Dispose of used batteries according to the manufacturer's instructions.



### CAUTION!

Risk of explosion if battery is replaced incorrectly or with an incorrect type. Replace the battery only with the same or equivalent type recommended by the manufacturer. Dispose of used batteries according to the manufacturer's instructions.

## Electrostatic Discharge (ESD)



### CAUTION!

ESD CAN DAMAGE DRIVES, BOARDS, AND OTHER PARTS. WE RECOMMEND THAT YOU PERFORM ALL PROCEDURES AT AN ESD WORKSTATION. IF ONE IS NOT AVAILABLE, PROVIDE SOME ESD PROTECTION BY WEARING AN ANTI-STATIC WRIST STRAP ATTACHED TO CHASSIS GROUND -- ANY UNPAINTED METAL SURFACE -- ON YOUR SERVER WHEN HANDLING PARTS.

Always handle boards carefully. They can be extremely sensitive to ESD. Hold boards only by their edges without any component and pin touching. After removing a board from its protective wrapper or from the system, place the board component side up on a grounded, static free surface. Use a conductive foam pad if available but not the board wrapper. Do not slide board over any surface.

**System power on/off:** To remove power from system, you must remove the system from rack. Make sure the system is removed from the rack before opening the chassis, adding, or removing any non hot-plug components.

**Hazardous conditions, devices and cables:** Hazardous electrical conditions may be present on power, telephone, and communication cables. Turn off the system and disconnect the cables attached to the system before servicing it. Otherwise, personal injury or equipment damage can result.

**Electrostatic discharge (ESD) and ESD protection:** ESD can damage drives, boards, and other parts. We recommend that you perform all procedures in this chapter only at an ESD workstation. If one is not available, provide some ESD protection by wearing an antistatic wrist strap attached to chassis ground (any unpainted metal surface on the server) when handling parts.

**ESD and handling boards:** Always handle boards carefully. They can be extremely sensitive to electrostatic discharge (ESD). Hold boards only by their edges. After removing a board from its protective wrapper or from the system, place the board component side up on a grounded, static free surface. Use a conductive foam pad if available but not the board wrapper. Do not slide board over any surface.

**Installing or removing jumpers:** A jumper is a small plastic encased conductor that slips over two jumper pins. Some jumpers have a small tab on top that can be gripped with fingertips or with a pair of fine needle nosed pliers. If the jumpers do not have such a tab, take care when using needle nosed pliers to remove or install a jumper; grip the narrow sides of the jumper with the pliers, never the wide sides. Gripping the wide sides can damage the contacts inside the jumper, causing intermittent problems with the function controlled by that jumper. Take care to grip with, but not squeeze, the pliers or other tool used to remove a jumper, or the pins on the board may bend or break.

# Table of Contents

|  |    |
|--|----|
| Chapter 1 Hardware Installation .....                | 9  |
| 1-1 Installation Precautions .....                   | 9  |
| 1-2 Product Specifications .....                     | 10 |
| 1-3 System Block Diagram .....                       | 14 |
| Chapter 2 System Appearance .....                    | 15 |
| 2-1 Front View .....                                 | 15 |
| 2-2 Rear View .....                                  | 16 |
| 2-3 Front Panel LEDs and Buttons .....               | 17 |
| 2-3-1 RoT LEDs .....                                 | 18 |
| 2-4 Rear System LAN LEDs .....                       | 20 |
| 2-5 Power Supply Unit (PSU) LED .....                | 21 |
| 2-6 Hard Disk Drive LEDs .....                       | 22 |
| Chapter 3 System Hardware Installation .....         | 23 |
| 3-1 Removing Chassis Cover .....                     | 24 |
| 3-2 Removing and Installing the Fan Duct .....       | 25 |
| 3-3 Removing and installing the Heat Sink .....      | 26 |
| 3-4 Installing the CPU .....                         | 27 |
| 3-5 Installing the Memory .....                      | 29 |
| 3-5-1 Eight Channel Memory Configuration .....       | 29 |
| 3-5-2 Installing the Memory .....                    | 30 |
| 3-5-3 DIMM Population Table .....                    | 30 |
| 3-5-4 Processor and Memory Module Matrix Table ..... | 31 |
| 3-6 Installing the PCI Expansion Card .....          | 32 |
| 3-7 Installing the Mezzanine Card .....              | 33 |
| 3-7-1 OCP 3.0 .....                                  | 33 |
| 3-8 Installing the Hard Disk Drive .....             | 34 |
| 3-9 Installing the M.2 Device and Heat Sink .....    | 36 |
| 3-10 Replacing the Fan Assembly .....                | 37 |
| 3-11 Replacing the Power Supply .....                | 38 |
| 3-12 Cable Routing .....                             | 39 |
| Chapter 4 Motherboard Components .....               | 43 |
| 4-1 Motherboard Components .....                     | 43 |
| 4-2 Jumper Setting .....                             | 45 |

|           |   |     |
|-----------|---|-----|
| 4-3       | Backplane Board Storage Connector .....       | 46  |
| 4-3-1     | CBP20C5.....                                  | 46  |
| Chapter 5 | BIOS Setup .....                              | 47  |
| 5-1       | The Main Menu .....                           | 49  |
| 5-2       | Advanced Menu .....                           | 52  |
| 5-2-1     | Trusted Computing.....                        | 53  |
| 5-2-2     | Serial Port Console Redirection .....         | 54  |
| 5-2-3     | SIO Configuration .....                       | 57  |
| 5-2-4     | PCI Subsystem Settings.....                   | 58  |
| 5-2-5     | USB Configuration.....                        | 60  |
| 5-2-6     | Network Stack Configuration .....             | 61  |
| 5-2-7     | Post Report Configuration .....               | 62  |
| 5-2-8     | KMIP Server Configuration .....               | 63  |
| 5-2-9     | NVMe Configuration .....                      | 65  |
| 5-2-10    | Chipset Configuration .....                   | 66  |
| 5-2-11    | Tls Auth Configuration .....                  | 67  |
| 5-2-12    | iSCSI Configuration .....                     | 68  |
| 5-2-13    | Intel(R) Ethernet Controller I210.....        | 69  |
| 5-2-14    | VLAN Configuration.....                       | 71  |
| 5-2-15    | Driver Health.....                            | 72  |
| 5-3       | Chipset Menu.....                             | 73  |
| 5-3-1     | Processor Configuration .....                 | 74  |
| 5-3-2     | Common RefCode Configuration .....            | 77  |
| 5-3-3     | UPI Configuration .....                       | 78  |
| 5-3-4     | Memory Configuration .....                    | 80  |
| 5-3-5     | IIO Configuration .....                       | 83  |
| 5-3-6     | Advanced Power Management Configuration ..... | 85  |
| 5-3-7     | Miscellaneous Configuration .....             | 87  |
| 5-3-8     | Runtime Error Logging Settings .....          | 88  |
| 5-3-9     | Power Policy.....                             | 90  |
| 5-4       | Server Management Menu.....                   | 92  |
| 5-4-1     | System Event Log .....                        | 94  |
| 5-4-2     | View FRU Information .....                    | 95  |
| 5-4-3     | BMC VLAN Configuration.....                   | 96  |
| 5-4-4     | BMC Network Configuration .....               | 97  |
| 5-4-5     | IPv6 BMC Network Configuration .....          | 98  |
| 5-5       | Security Menu .....                           | 99  |
| 5-5-1     | Secure Boot .....                             | 100 |
| 5-6       | Boot Menu.....                                | 103 |

|       |   |     |
|-------|---|-----|
| 5-7   | Save & Exit Menu.....                   | 105 |
| 5-8   | BIOS Recovery .....                     | 107 |
| 5-9   | BIOS POST Beep code (AMI standard)..... | 108 |
| 5-9-1 | PEI Beep Codes .....                    | 108 |
| 5-9-2 | DXE Beep Codes .....                    | 108 |



# Chapter 1 Hardware Installation

## 1-1 Installation Precautions

The motherboard/system contain numerous delicate electronic circuits and components which can become damaged as a result of electrostatic discharge (ESD). Prior to installation, carefully read the service guide and follow these procedures:









- Prior to installation, do not remove or break motherboard S/N (Serial Number) sticker or warranty sticker provided by your dealer. These stickers are required for warranty validation.
- Always remove the AC power by unplugging the power cord from the power outlet before installing or removing the motherboard or other hardware components.
- When connecting hardware components to the internal connectors on the motherboard, make sure they are connected tightly and securely.
- When handling the motherboard, avoid touching any metal leads or connectors.
- It is best to wear an electrostatic discharge (ESD) wrist strap when handling electronic components such as a motherboard, CPU or memory. If you do not have an ESD wrist strap, keep your hands dry and first touch a metal object to eliminate static electricity.
- Prior to installing the motherboard, please have it on top of an antistatic pad or within an electrostatic shielding container.
- Before unplugging the power supply cable from the motherboard, make sure the power supply has been turned off.
- Before turning on the power, make sure the power supply voltage has been set according to the local voltage standard.
- Before using the product, please verify that all cables and power connectors of your hardware components are connected.
- To prevent damage to the motherboard, do not allow screws to come in contact with the motherboard circuit or its components.
- Make sure there are no leftover screws or metal components placed on the motherboard or within the computer casing.
- Do not place the computer system on an uneven surface.
- Do not place the computer system in a high-temperature environment.
- Turning on the computer power during the installation process can lead to damage to system components as well as physical harm to the user.
- If you are uncertain about any installation steps or have a problem related to the use of the product, please consult a certified computer technician.







# 1-2 Product Specifications



**NOTE:**

We reserve the right to make any changes to the product specifications and product-related information without prior notice.

|   |   |
|---|---|
|  System    | <ul style="list-style-type: none"><li>◆ 2U</li></ul>  |
|  Dimension | <ul style="list-style-type: none"><li>◆ 438mm (W) x 87.5mm (H) x 710mm (D)</li></ul>  |
|  CPU       | <ul style="list-style-type: none"><li>◆ Intel® Xeon® 6 Processors<ul style="list-style-type: none"><li>- Intel® Xeon® 6700E-Series Processors</li><li>- Intel® Xeon® 6700P-Series Processors (available Q1'25)</li><li>- Intel® Xeon® 6500P-Series Processors (available Q1'25)</li></ul></li><li>◆ Single processor, TDP up to 350W</li></ul>  |
|  Socket    | <ul style="list-style-type: none"><li>◆ 1 x LGA 4710</li><li>◆ Socket E2</li></ul>  |
|  Chipset   | <ul style="list-style-type: none"><li>◆ System on Chip</li></ul>  |
|  Memory    | <ul style="list-style-type: none"><li>◆ 16 x DIMM slots</li><li>◆ DDR5 memory supported</li><li>◆ 8-Channel memory architecture</li><li>◆ MCR DIMM supported <sup>[1]</sup></li><li>◆ RDIMM: Up to 6400 MT/s (1DPC), 5200 MT/s (2DPC)</li><li>◆ MCR DIMM: Up to 8000 MT/s</li></ul> <p><sup>[1]</sup> MCR DIMMs are only supported with Intel® Xeon® 6 Processors with P-cores and in a 1DPC configuration.</p>   |
|  LAN       | <p><b>Rear side:</b></p> <ul style="list-style-type: none"><li>◆ 1 x 1Gb/s LAN port (1 x Intel® I210-AT)</li><li>◆ Supports NCSI function</li></ul><br><ul style="list-style-type: none"><li>◆ 1 x 10/100/1000 management LAN</li></ul>   |
|  Video   | <ul style="list-style-type: none"><li>◆ Integrated in Aspeed® AST2600</li><li>- 1 x Mini-DP</li></ul>   |
|  Storage | <p><b>Front hot-swap:</b></p> <ul style="list-style-type: none"><li>◆ 12 x 3.5"/2.5" Gen5 NVMe/SATA/<b>SAS-4</b> <sup>[1]</sup></li></ul> <p><b>Internal M.2:</b></p> <ul style="list-style-type: none"><li>◆ 1 x M.2 (2280/22110), PCIe Gen5 x2</li><li>◆ 1 x M.2 (2280/22110), PCIe Gen5 x2, <b>shared with SATA</b> <sup>[2]</sup></li></ul> <p><sup>[1]</sup> SAS card is required to support SAS drives.<br/><sup>[2]</sup> To enable the M.2 slot, please adjust the switch according to the manual for proper support.</p> |

|   |                  |   |
|---|------------------|---|
|  | SAS              | <ul style="list-style-type: none"> <li>◆ Require SAS add-in cards</li> </ul>  |
|  | RAID             | <ul style="list-style-type: none"> <li>◆ Require RAID add-in cards</li> <li>◆ Onboard VROC key header</li> </ul>  |
|  | Expansion Slot   | <ul style="list-style-type: none"> <li>◆ <b>Riser Card CRS201C:</b> <ul style="list-style-type: none"> <li>- 1 x FHHL x16 (Gen5 x16)</li> <li>- 1 x OCP NIC 3.0 (Gen5 x16) - Supports NCSI function</li> <li>- 1 x OCP NIC 3.0 (Gen5 x16), <b>disabled for NVMe</b></li> </ul> </li> </ul>  |
|  | Front I/O        | <ul style="list-style-type: none"> <li>◆ 2 x USB 3.2 Gen1 ports (Type-A)</li> <li>◆ 1 x Power button with LED</li> <li>◆ 1 x ID button with LED</li> <li>◆ 1 x NMI button</li> <li>◆ 1 x Reset button</li> <li>◆ 2 x LAN activity LEDs (1 x LED disabled)</li> <li>◆ 1 x Storage activity LED</li> <li>◆ 1 x System status LED</li> </ul> |
|  | Rear I/O         | <ul style="list-style-type: none"> <li>◆ 2 x USB 3.2 Gen1 ports (Type-A)</li> <li>◆ 1 x Mini-DP</li> <li>◆ 1 x RJ45 port</li> <li>◆ 1 x MLAN port</li> <li>◆ 1 x ID button with LED</li> </ul>  |
|  | Backplane Board  | <ul style="list-style-type: none"> <li>◆ Speed and bandwidth:</li> <li>◆ PCIe Gen5 x4 or SATA 6Gb/s or SAS-4 24Gb/s</li> </ul>  |
|  | Security Modules | <ul style="list-style-type: none"> <li>◆ 1 x TPM header with SPI interface</li> <li>- <b>Optional</b> TPM2.0 kit: CTM012</li> <li>◆ 1 x PROt connector (<b>only enabled on RoT SKU</b>)</li> </ul>  |

Power Supply ♦ 1+1 1600W 80 PLUS Titanium redundant power supplies

- ♦ AC Input:
  - 100-127V~/ 12A, 50-60Hz
  - 200-240V~/ 10A, 50-60Hz
- ♦ DC Input:(Only for China)
  - 240Vdc/ 8A
- ♦ DC Output:
  - Max 1000W/ 100-127V~
  - +12.2V/ 82A
  - +12.2Vsb/ 3A
  - Max 1600W/ 200-240V~ or 240Vdc Input
  - +12.2V/ 132A
  - +12.2Vsb/ 3A

**NOTE** GIGABYTE provides PSUs with various energy efficiency ratings and power outputs. Please contact our sales representatives to determine the best configuration for your system..



System Management

- ♦ Aspeed® AST2600 Baseboard Management Controller
- ♦ GIGABYTE Management Console web interface
  - ♦ Dashboard
  - ♦ HTML5 KVM
  - ♦ Sensor Monitor (Voltage, RPM, Temperature, CPU Status ...etc.)
  - ♦ Sensor Reading History Data
  - ♦ FRU Information
  - ♦ SEL Log in Linear Storage / Circular Storage Policy
  - ♦ Hardware Inventory
  - ♦ Fan Profile
  - ♦ System Firewall
  - ♦ Power Consumption
  - ♦ Power Control
  - ♦ Advanced power capping
  - ♦ LDAP / AD / RADIUS Support
  - ♦ Backup & Restore Configuration
  - ♦ Remote BIOS/BMC/CPLD Update
  - ♦ Event Log Filter
  - ♦ User Management
  - ♦ Media Redirection Settings
  - ♦ PAM Order Settings
  - ♦ SSL Settings
  - ♦ SMTP Settings



OS Compatibility

- ♦ Please refer to OS compatibility table in support page



#### System Fans

- ◆ 4 x 80x80x38mm (18,300rpm)



#### Operating Properties

- ◆ Operating temperature: 10°C to 35°C
- ◆ Operating humidity: 8-80% (non-condensing)
- ◆ Non-operating temperature: -40°C to 60°C
- ◆ Non-operating humidity: 20%-95% (non-condensing)

# 1-3 System Block Diagram

8-Channel DDR5, 16 x DIMMs  
 RDIMM: Up to 6400 MT/s (110PC), 5200 MT/s (20PC)  
 MCR DIMM: Up to 8000 MT/s

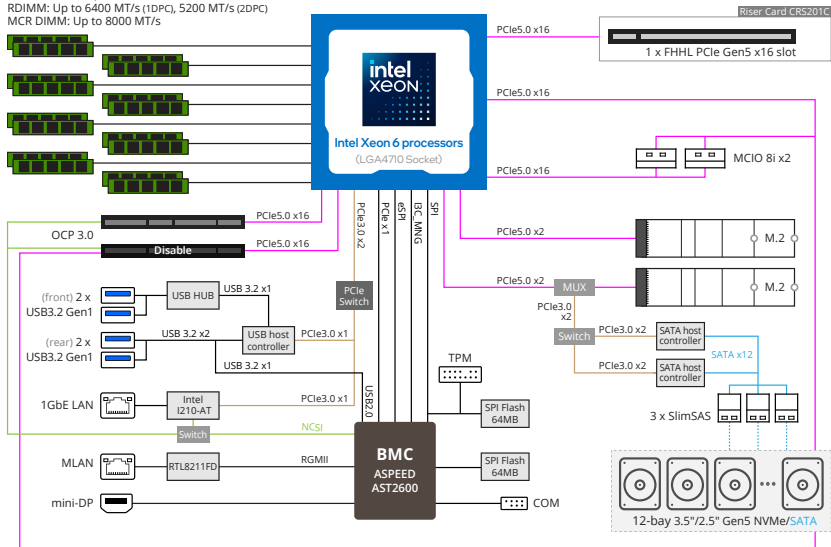

# Chapter 2 System Appearance

## 2-1 Front View

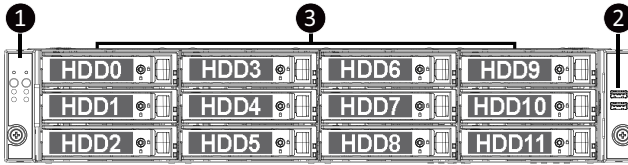

| No.  | Description                  |
|--|------------------------------|
| 1.   | Front Panel LEDs and Buttons |
| 2.   | Front USB 3.2 Gen1 Ports     |
| 3.   | 3.5"/2.5" Drive Bays         |
| <b>NOTE! Drives with green latches support NVMe.</b> |                              |



- Please Go to Chapter 2-3 Front Panel LED and Buttons for detail description of function LEDs.

## 2-2 Rear View

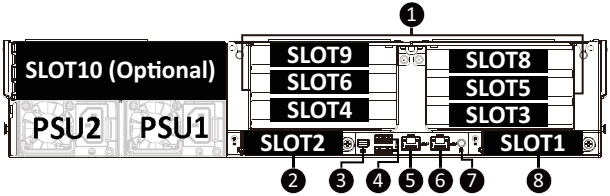

| No. | Description                            |
|-----|--|
| 1.  | PCIe Slot                              |
| 2.  | OCP 3.0 Slot (Option/SFF)              |
| 3.  | Mini DP Port                           |
| 4.  | USB 3.2 Gen1 Port x 2                  |
| 5.  | 10/100/1000 Server Management LAN Port |
| 6.  | 1GbE LAN Port                          |
| 7.  | ID Button                              |
| 8.  | OCP 3.0 Slot (Option/SFF)              |

**NOTE! SLOT2 and SLOT10 are available on specific models.**



## 2-3 Front Panel LEDs and Buttons

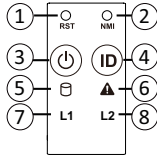

| No. | Name                                | Color       | Status   | Description   |
|-----|-------------------------------------|-------------|----------|---|
| 1.  | Reset Button                        |             |          | Press the button to reset the system.   |
| 2.  | NMI button                          |             |          | Press the button server generates a NMI to the processor if the multiple-bit ECC errors occur, which effectively halt the server. |
| 3.  | Power button with LED               | Green       | On       | System is powered on  |
|     |                                     | N/A         | Off      | System is not powered on or in ACPI S5 state (power off)  |
| 4.  | ID Button <sup>(Note)</sup>         |             |          | Press the button to activate system identification  |
| 5.  | HDD Status LED                      | Green       | On       | HDD locate  |
|     |                                     |             | Blink    | HDD access  |
|     |                                     | Amber       | On       | HDD fault   |
|     |                                     | Green/Amber | Blink    | HDD rebuilding  |
|     |                                     | N/A         | Off      | No HDD access or no HDD fault.  |
| 6.  | System Status LED <sup>(Note)</sup> | Green       | Solid On | System is operating normally.   |
|     |                                     |             | Amber    | Solid On  |
|     |                                     | Blink       |          | Non-critical condition, may indicate:<br>Redundant power module failure<br>Temperature and voltage issue<br>Chassis intrusion     |
|     |                                     | N/A         | Off      | System is not ready, may indicate:<br>POST error; NMI error; Processor or terminator missing                                      |
| 7.  | LAN 1 Active/Link LED               | Green       | Solid On | Link between system and network or no access.   |
|     |                                     | Green       | Blink    | Data transmission or receiving is occurring   |
|     |                                     | N/A         | Off      | No data transmission or receiving is occurring  |
| 8.  | LAN 2 Active/Link LED               |             |          | The function is disabled.   |

(Note) If your server features RoT function, please see the following section for detail LED behavior.

2-3-1 RoT LEDs

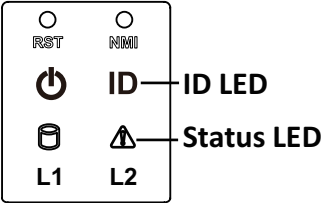

| State   | LED on Front Panel |   | LED on PRoT Module |
|---|--------------------|---|--------------------|
|   | ID LED             | Status LED  | Live LED           |
| <b>AST1060 FW Active Authentication fail</b>                                |                    |   |                    |
| <b>AST1060:</b><br>Recovering active region                                 | 4Hz                | Green and Amber Blink alternately at 4Hz<br>[Green, Amber, Green, Amber, and so on] | 4Hz                |
| <b>AST1060 FW Active and Recovery Authentication fail</b>                   |                    |   |                    |
| Endless attempts to boot from active or recovery.                           | On                 | Off   | Off                |
| <b>Authenticating BMC/BIOS Images</b>                                       |                    |   |                    |
| Authenticating Images   | Off                | Off   | 2Hz                |
| <b>BMC/BIOS Images Authentication Pass</b>                                  |                    |   |                    |
| <b>BMC :</b><br>Authentication pass<br><b>BIOS :</b><br>Authentication pass | Off                | Off   | 0.5Hz              |

| State   | LED on Front Panel |                    | LED on PRoT Module |
|---|--------------------|--------------------|--------------------|
|   | ID LED             | Status LED         | Live LED           |
| <b>Recovering BMC/BIOS Images</b>   |                    |                    |                    |
| <b>BMC :</b><br>Recovering active region                                      | 4Hz                | Green Blink at 4Hz | 4Hz                |
| <b>BIOS :</b><br>Recovering active region                                     | 4Hz                | Amber Blink at 4Hz | 4Hz                |
| <b>BMC :</b><br>Recovering recovery region<br>(If the staging region exists)  | 4Hz                | Green On           | 4Hz                |
| <b>BIOS :</b><br>Recovering recovery region<br>(If the staging region exists) | 4Hz                | Amber On           | 4Hz                |
| <b>BMC/BIOS Images Active and Recovery region Authentication Fail</b>         |                    |                    |                    |
| <b>BMC :</b><br>Active and Recovery authentication fail                       | On                 | Green On           | 2Hz                |
| <b>BIOS :</b><br>Active and Recovery authentication fail                      | On                 | Amber On           | 2Hz                |

**NOTE!**

1. When the BMC/BIOS starts, the LEDs will be controlled by the BMC/BIOS.

## 2-4 Rear System LAN LEDs

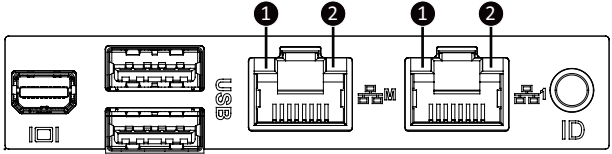

| No. | Name                   | Color  | Status | Description                                    |
|-----|------------------------|--------|--------|--|
| 1.  | 1GbE Speed LED         | Yellow | On     | 1 Gbps data rate                               |
|     |                        | Green  | On     | 100 Mbps data rate                             |
|     |                        | N/A    | Off    | 10 Mbps data rate                              |
| 2.  | 1GbE Link/Activity LED | Green  | On     | Link between system and network or no access   |
|     |                        |        | Blink  | Data transmission or receiving is occurring    |
|     |                        | N/A    | Off    | No data transmission or receiving is occurring |

## 2-5 Power Supply Unit (PSU) LED



### NOTE!

The power supply may vary based on the system configuration.

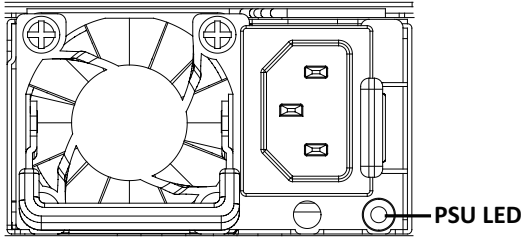

| State              | Description   |
|--------------------|---|
| OFF                | No AC power to all power supplies   |
| 1Hz Green Blinking | AC present / only standby on / Cold redundant mode  |
| 2Hz Green Blinking | Power supply firmware updating mode   |
| Amber              | AC cord unplugged or AC power lost; with a second power supply in parallel still with AC input power                      |
|                    | Power supply critical event causing shut down: failure, OCP, OVP, fan failure and UVP                                     |
| 1Hz Amber Blinking | Power supply warning events where the power supply continues to operate: high temp, high power, high current and slow fan |

## 2-6 Hard Disk Drive LEDs

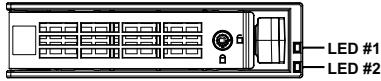

| RAID SKU  |                                      | LED #1 | Locate | HDD Fault | Rebuilding        | HDD Access | HDD Present (No Access) |
|---|--------------------------------------|--------|--------|-----------|-------------------|------------|-------------------------|
| No RAID configuration (via PCH, HBA)                  | Disk LED (LED on Back Panel)         | Green  | ON(*1) | OFF       |                   | BLINK (*2) | OFF                     |
|   |                                      | Amber  | OFF    | OFF       |                   | OFF        | OFF                     |
|   | Removed HDD Slot (LED on Back Panel) | Green  | ON(*1) | OFF       |                   | --         | --                      |
|   |                                      | Amber  | OFF    | OFF       |                   | --         | --                      |
| RAID configuration (via HW RAID Card or SW RAID Card) | Disk LED                             | Green  | ON     | OFF       |                   | BLINK (*2) | OFF                     |
|   |                                      | Amber  | OFF    | ON        | (Low Speed: 2 Hz) | OFF        | OFF                     |
|   | Removed HDD Slot                     | Green  | ON(*1) | OFF       | (*3)              | --         | --                      |
|   |                                      | Amber  | OFF    | ON        | (*3)              | --         | --                      |

| LED #2 | HDD Present | No HDD |
|--------|-------------|--------|
| Green  | ON          | OFF    |

**NOTE:**

\*1: Depends on HBA/Utility Spec.

\*2: Blink cycle depends on HDD's activity signal.

\*3: If HDD is pulled out during rebuilding, the disk status of this HDD is regarded as faulty.

## Chapter 3 System Hardware Installation



### Pre-installation Instructions

Computer components and electronic circuit boards can be damaged by electrostatic discharge. Working on computers that are still connected to a power supply can be extremely dangerous. Follow the simple guidelines below to avoid damage to your computer or injury to yourself.

- Always disconnect the computer from the power outlet whenever you are working inside the computer case.
- If possible, wear a grounded wrist strap when you are working inside the computer case. Alternatively, discharge any static electricity by touching the bare metal system of the computer case, or the bare metal body of any other grounded appliance.
- Hold electronic circuit boards by the edges only. Do not touch the components on the board unless it is necessary to do so. Do not flex or stress the circuit board.
- Leave all components inside the static-proof packaging until you are ready to use the component for the installation.

## 3-1 Removing Chassis Cover



Before you remove or install the system cover

- Make sure the system is not turned on or connected to AC power.

**Follow these instructions to remove the chassis cover:**

1. Remove the screw securing the chassis cover.
2. Push button to unlock the handle.
3. Pull the grip handle to open the panel cover.
4. Slide the chassis cover towards the rear and remove the chassis cover in the direction indicated.
5. To reinstall the chassis cover reverse steps 1-4.

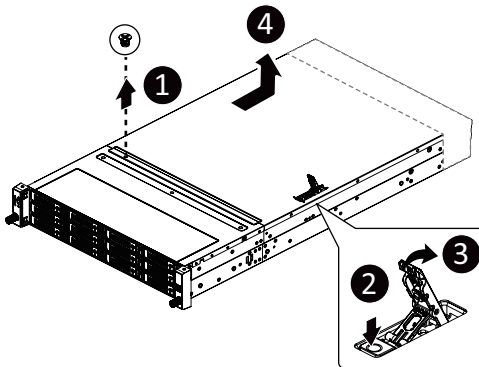



### 3-2 Removing and Installing the Fan Duct

Follow these instructions to remove/install the fan duct:

1. Lift up to remove the fan duct
2. To install the fan duct, align the fan duct with the guiding groove. Push down the fan duct into chassis until its firmly seat.

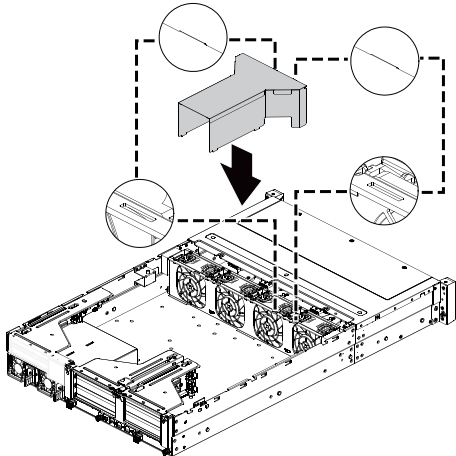
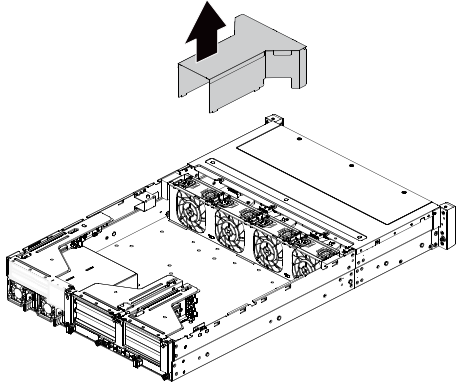

### 3-3 Removing and installing the Heat Sink



Read the following guidelines before you begin to remove/install the heat sink:

- Always turn off the computer and unplug the power cord from the power outlet before installing the heat sink to prevent hardware damage.
- Unplug all cables from the power outlets.
- Disconnect all telecommunication cables from their ports.
- Place the system unit on a flat and stable surface.
- Open the system according to the instructions.



#### **WARNING!**

Failure to turn off the server before you start installing components may cause serious damage. Do not attempt the procedures described in the following sections unless you are a qualified service technician.

#### **Follow these instructions to remove/install the heat sink:**

1. Loosen the captive screws securing the heat sink in place in reverse order (4→3→2→1).
2. Move the rotating wires into the unlatch position.
3. Lift and remove the heat sink from the system.
4. To reinstall the heat sink reverse steps 1-3 while ensuring that you tighten the captive screws in sequential order (1→2→3→4).

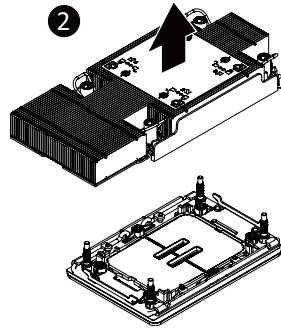
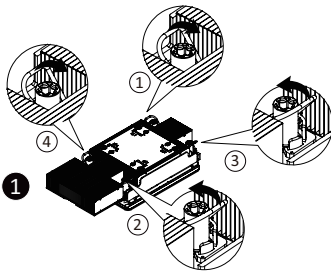

- | When installing the heatsink to CPU, use T30-Lobe driver to tighten 4 captive nuts in sequence as 1-4.
- Please refer to the Heatsink Label for the screw tightening torque value.

## 3-4 Installing the CPU



Read the following guidelines before you begin to install the CPU:

- Make sure that the motherboard supports the CPU.
- Always turn off the computer and unplug the power cord from the power outlet before installing the CPU to prevent hardware damage.
- Unplug all cables from the power outlets.
- Disconnect all telecommunication cables from their ports.
- Place the system unit on a flat and stable surface.
- Open the system according to the instructions.



### WARNING!

Failure to properly turn off the server before you start installing components may cause serious damage. Do not attempt the procedures described in the following sections unless you are a qualified service technician.

### Follow these instructions to Install the CPU:

1. Align and install the processor on the carrier.  
**NOTE:** Apply thermal compound evenly on the top of the CPU. Remove the protective cover from the underside of the heat sink.
2. Carefully flip the heat sink cover. Then install the carrier assembly on the bottom of the heat sink and make sure the gold arrow is located in the correct direction.
3. Remove the CPU cover.  
**NOTE:** Save the CPU cover in the event that you need to remove the CPU from the socket.
4. Align the heat sink with the CPU socket by the guide pins and make sure the gold arrow is located in the correct direction. Then place the heat sink onto the top of the CPU socket.
5. Position the rotating wires into the latch position. Tighten the screws in sequential order (1→2→3→4).  
**NOTE:** When disassembling the heat sink, loosen the screws in reverse order (4→3→2→1) and then move the rotating wires into the unlatch position.

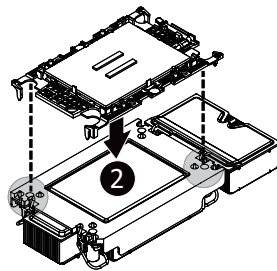
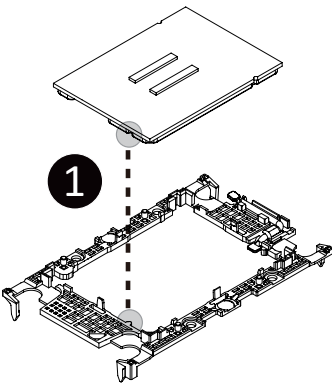

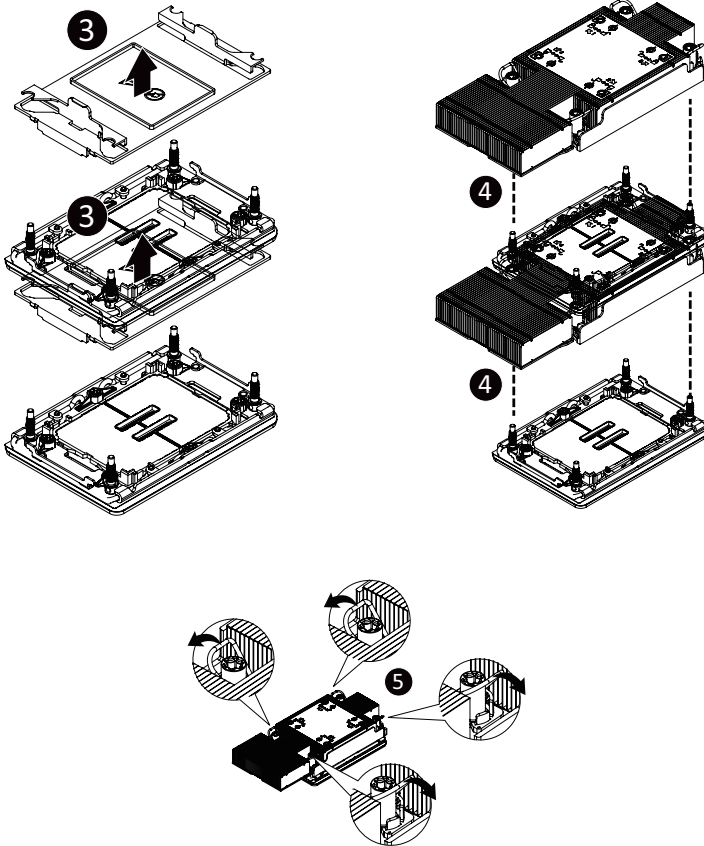

### Carrier Types used for Package Types

| Package Type               | Granite Rapids-SP XCC | Granite Rapids-SP HCC<br>Granite Rapids-SP LCC<br>Sierra Forest-SP<br>Clearwater Forest-SP |
|----------------------------|-----------------------|--|
| Carrier Code               | E2A                   | E2B  |
| Shim?                      | No                    | Yes  |
| Integrated TIM Break Lever | Yes                   | Yes  |

#### NOTE!

- The carrier code is marked on each carrier and matches a code laser marked on to the IHS(Integrated Heat Spreader) to ensure the right parts are used together
- When installing the heat sink to CPU, use T30-Lobe driver to tighten 4 captive nuts in sequence as 1-4.
- The screw tightening torque:  $8 \pm 0.5$  kgf-cm.

## 3-5 Installing the Memory



Read the following guidelines before you begin to install the memory:

- Make sure that the motherboard supports the memory. It is recommended that memory of the same capacity, brand, speed, and chips be used.
- Always turn off the computer and unplug the power cord from the power outlet before installing the memory to prevent hardware damage.
- Memory modules have a foolproof design. A memory module can be installed in only one direction. If you are unable to insert the memory, switch the direction.

### 3-5-1 Eight Channel Memory Configuration

This motherboard provides 16 DDR5 memory slots and supports 8-Channel Technology. After the memory is installed, the BIOS will automatically detect the specifications and capacity of the memory.

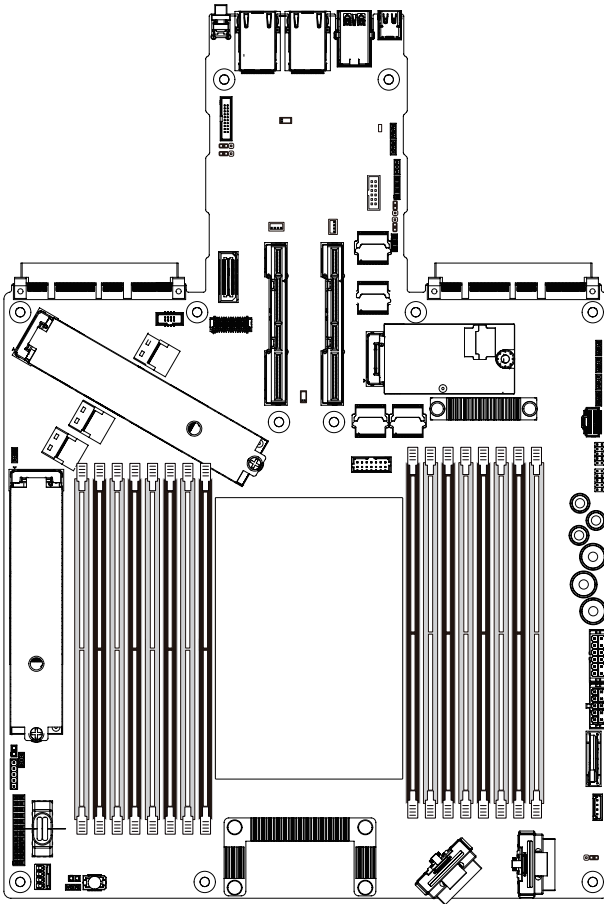

### 3-5-2 Installing the Memory



Before installing a memory module, make sure to turn off the computer and unplug the power cord from the power outlet to prevent damage to the memory module.

Be sure to install DDR5 DIMMs on this motherboard.

Follow these instructions to install the Memory:

1. Insert the DIMM memory module vertically into the DIMM slot, and push it down.
2. Close the plastic clip at both edges of the DIMM slots to lock the DIMM module.
3. Reverse the installation steps when you want to remove the DIMM module.

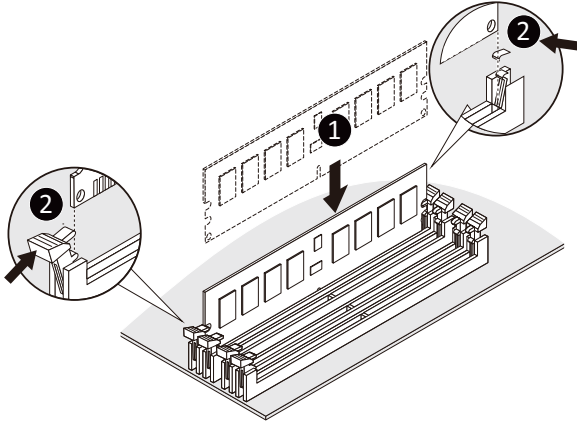

### 3-5-3 Processor and Memory Module Matrix Table

| Memory Q'ty<br>for each CPU | CPU0 |    |    |    |    |    |    |    |    |    |    |    |    |    |    |    |
|-----------------------------|------|----|----|----|----|----|----|----|----|----|----|----|----|----|----|----|
|                             | H0   | H1 | G0 | G1 | F0 | F1 | E0 | E1 | A1 | A0 | B1 | B0 | C1 | C0 | D1 | D0 |
| 1 DIMM                      |      |    |    |    |    |    |    |    |    | V  |    |    |    |    |    |    |
| 4 DIMM                      |      |    | V  |    |    |    | V  |    |    | V  |    |    |    | V  |    |    |
|                             | V    |    |    |    | V  |    |    |    |    |    |    | V  |    |    |    | V  |
| 8 DIMM                      | V    |    | V  |    | V  |    | V  |    |    | V  |    | V  |    | V  |    | V  |
|                             |      |    | V  | V  |    |    | V  | V  | V  | V  |    |    | V  | V  |    |    |
|                             | V    | V  |    |    | V  | V  |    |    |    |    | V  | V  |    |    | V  | V  |
| 12 DIMM                     | V    |    | V  | V  | V  |    | V  | V  | V  | V  |    | V  | V  | V  |    | V  |
| 16 DIMM                     | V    | V  | V  | V  | V  | V  | V  | V  | V  | V  | V  | V  | V  | V  | V  | V  |

**NOTE!**

- Xeon 6700E/6500E-series do not support 12 DIMMs Configuration.

### 3-5-4 DIMM Population Table

#### Intel Xeon 6700E-Series Memory Support

| Type  | Ranks Per DIMM and Data Width | DIMM Capacity (GB) |      |      |      |       |       | Channel Speed (MT/s); Voltage (V); Slots per Channel (SPC) & DIMMs per Channel (DPC) |                                     |
|-------|-------------------------------|--------------------|------|------|------|-------|-------|--|-------------------------------------|
|       |                               | DRAM Density       |      |      |      |       |       | 1DPC/2SPC  | 2DPC/2SPC                           |
|       |                               | 16Gb               |      |      | 24Gb |       |       |  |                                     |
|       |                               | 1DPC               | 2DPC | 1DPC | 2DPC | 1DPC  | 2DPC  | 1.1V   |                                     |
| RDIMM | 1Rx4                          | 32GB               |      |      |      |       |       | 6400, 6000,  | NA                                  |
|       | 2Rx8                          | 32GB               |      |      |      |       |       | 5600, 5200, 4800   | NA                                  |
|       | 2Rx4                          | 64GB               | 64GB | 96GB | 96GB |       |       | (DDR5-6400 rated RDIMMS only)  | 5200, 4800                          |
|       | 2Rx4                          |                    |      |      |      | 128GB | 128GB |  | (DDR5-6400 rated RDIMMS only)<br>NA |

#### Intel Xeon 6700E-Series CXL Memory Support

| Native DDR5 Memory Per Socket |                           |           |                   | CXL Memory Per Socket |                 |                                |                |                         |
|-------------------------------|---------------------------|-----------|-------------------|-----------------------|-----------------|--------------------------------|----------------|-------------------------|
| Slot 0 DIMM Ranks             | Slot 0 DIMM Capacity (GB) | DIMM Type | DRAM Density (Gb) | CXL Memory Channels   | CXL Memory Type | CXL Capacity Per Device/Module | CXL Interleave | CXL Mode                |
| 2Rx4                          | 64                        | 10x4      | 16                | 2+2                   | DDR5 x8         | 64 GB                          | 1x4*, 2x2, 4x1 | 1LM+Vol                 |
| 2Rx4                          | 64                        | 10x4      | 16                | 1+1                   | DDR5 x16        | 128 GB                         | 1x2*, 2x1      | 1LM+Vol                 |
| 1Rx4                          | 32                        | 10x4      | 16                | 2                     | DDR5 x8         | 128 GB                         | 1x2*           | Intel® Flat Memory Mode |

**NOTE:**

- Intel Xeon 6700E-series CXL memory configs are 1DPC ('Slot 0') only for native DDR5
- CXL Memory Channel notation: # of devices per root port, with root ports separated by "+". i.e. 2+2+2+2 = four root ports populated with two devices per root port
- CXL Interleave notation: sets x ways. i.e. 2x4 = One set of two modules, interleaved four-way
- CXL Modes:
  - 1LM+Vol = DDR5 ('1LM') and (Volatile) CXL memory visible to SW as separate tiers, separately interleaved
  - Flat Memory Mode = HW manages data movement between DDR5 and CXL memory, total capacity visible to SW

## Intel Xeon 6500P/6700P-Series Memory Support

| Type      | Ranks Per DIMM and Data Width | DIMM Capacity (GB) |        |       |        |        |         | Channel Speed (MT/s); Voltage (V); Slots per Channel (SPC) & DIMMs per Channel Density (DPC) |                               |
|-----------|-------------------------------|--------------------|--------|-------|--------|--------|---------|--|-------------------------------|
|           |                               | DRAM Density       |        |       |        |        |         | 1DPC/2SPC  | 2DPC/2SPC                     |
|           |                               | 16Gb               |        | 24Gb  |        | 32Gb   |         |  |                               |
|           |                               | 1DPC               | 2DPC   | 1DPC  | 2DPC   | 1DPC   | 2DPC    | 1.1V   |                               |
| RDIMM     | 1Rx8                          | 16GB               |        | 24GB  |        |        |         | 6400, 6000,  |                               |
|           | 1Rx4                          | 32GB               |        | 48GB  |        |        |         | 5600, 5200, 4800   | 5200, 4800                    |
|           | 2Rx8                          | 32GB               | 32GB   | 48GB  |        |        |         | (DDR5-6400 rated RDIMMS only)  | (DDR5-6400 rated RDIMMS only) |
|           | 2Rx4                          | 64GB*              | 64GB*^ | 96GB* | 96GB*^ | 128GB* | 128GB*^ |  |                               |
| RDIMM 3DS | 8Rx4                          |                    | 256GB* |       |        |        |         |  |                               |
| MRDIMM    | 2Rx8                          | 32GB               |        |       |        |        |         | 8000, 7200   | N/A (no 2DPC)                 |
|           | 2Rx4                          | 64GB               |        |       |        |        |         | (MRDIMM-8800 only)   | configs for MRDIMM)           |

### NOTE:

- \*Supported in 1S/2S/4S systems
- ^Supported in 8S systems

## Intel Xeon 6500P/6700P-Series CXL Memory Support

| Native DDR5 Memory Per Socket |                          |           |                   | CXL Memory Per Socket |                    |                                 |                |                         |                 |
|-------------------------------|--------------------------|-----------|-------------------|-----------------------|--------------------|---------------------------------|----------------|-------------------------|-----------------|
| Slot0 DIMM Ranks              | Slot0 DIMM Capacity (GB) | DIMM Type | DRAM Density (Gb) | CXL Memory Channels   | CXL Memory Type    | CXL Capacity Per Device/ Module | CXL Interleave | CXL Mode                | 4S & 8S Support |
| 2Rx4                          | 96                       | 10x4      | 24                | 2+2                   | DDR5 x8            | 96 GB#                          | 1x4*, 2x2, 4x1 | 1LM+Vol                 | Yes             |
| 2Rx4                          | 128                      | 10x4      | 32                | 2+2                   | DDR4x8#<br>DDR5 x8 | 128 GB                          | 1x4*, 2x2, 4x1 | 1LM+Vol                 | Yes             |
| 2Rx4                          | 128                      | 10x4      | 32                | 2+2                   | DDR5 x8            | 128 GB                          | hetero x12     | Hetero                  | Yes             |
| 2Rx4                          | 64                       | 10x4      | 16                | 2+2+2                 | DDR5 x8            | 128 GB                          | 1x6*, 2x3, 3x2 | 1LM+Vol                 | No              |
| 2Rx4                          | 64                       | 10x4      | 16                | 2                     | DDR5 x8            | 128 GB                          | 1x2*           | 1LM+Vol                 | No              |
| 2Rx4                          | 64                       | 10x4      | 16                | 1+1                   | DDR5 x16           | 2ch 128 GB                      | 1x2*           | Intel® Flat Memory Mode | No              |

### NOTE:

- Xeon 6500P/6700P-series processors CXL memory configs are 1DPC ('Slot 0') only for native DDR5
- CXL Memory Channel notation: # of devices per root port, with root ports separated by "+". i.e. 2+2+2+2 = four root ports populated with two devices per root port
- CXL Interleave notation: sets x ways. i.e. 2x4 = Set of two modules, interleaved four-way
- CXL Modes:
  - 1LM+Vol = Native DDR5 ('1LM') and (volatile) CXL memory visible to SW as separate tiers, separately interleaved
  - Hetero x12 = DDR5 and (volatile) CXL memory interleaved together in one 12-way set (See graphic in next slide)
  - Flat Memory Mode = HW manages data movement between DDR5 and CXL memory, total capacity visible to SW



## 3-6 Installing the PCI Expansion Card



- Voltages can be present within the server whenever an AC power source is connected. This voltage is present even when the main power switch is in the off position. Ensure that the system is powered-down and all power sources have been disconnected from the server prior to installing a PCIe card.

Failure to observe these warnings could result in personal injury or damage to equipment.



- The PCIe riser assembly does not include a riser card or any cabling as standard. To install a PCIe card, a riser card must be installed.

### Follow these instructions for a PCI Expansion card:

1. Remove the screws and loosen the thumbscrew securing the riser bracket.
2. Lift up the riser bracket out of system.
3. Remove the screw securing the slot cover from the riser bracket.
4. Remove the slot covers from the riser bracket.
5. Orient the PCIe card with the riser guide slot and push in the direction of the arrow until the PCIe card sits in the PCIe card connector.
6. Secure the PCIe card with the screw.
7. Reverse the previous steps to install the riser bracket.

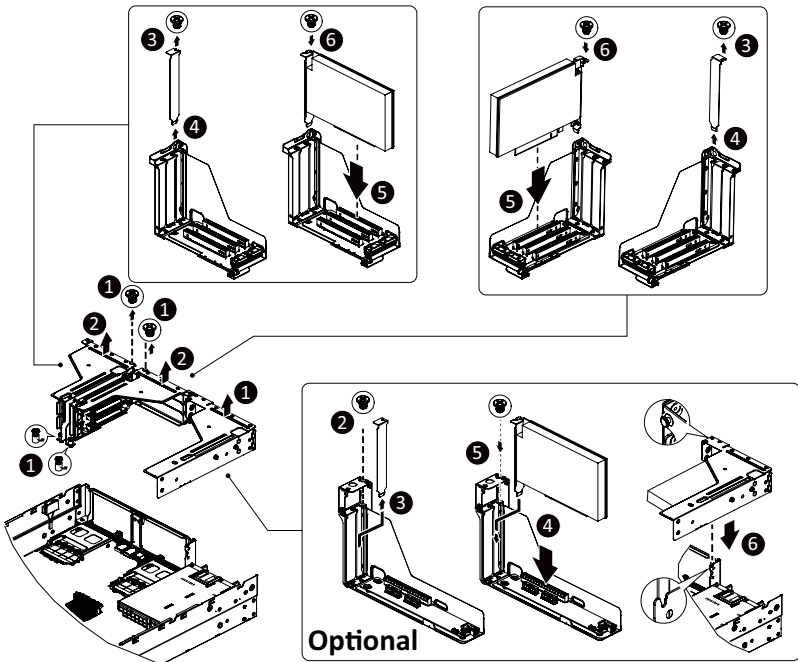

## 3-7 Installing the Mezzanine Card

### 3-7-1 OCP 3.0



Use of the following type of OCP 3.0 NIC is recommended:

- OCP 3.0 SFF with Pull Tab
- OCP 3.0 SFF with Ejector Latch

#### Follow these instructions to install an OCP 3.0 mezzanine card:

1. Remove the two screws securing the mezzanine card slot cover.
2. Remove the slot cover from the system.
3. Insert the OCP 3.0 mezzanine card into the card slot ensuring that the card is firmly connected to the connector on the motherboard.
4. Tighten the thumbnail screw to secure the OCP 3.0 mezzanine card in place.
5. Reverse the previous steps to replace the OCP 3.0 mezzanine card.

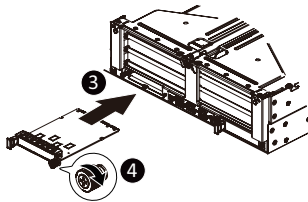
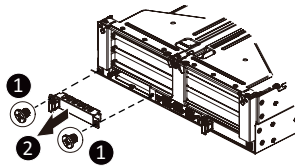

### 3-8 Installing the Hard Disk Drive



Read the following guidelines before you begin to install the HDD:

- Take note of the drive tray orientation before sliding it out.
- The tray will not fit back into the bay if inserted incorrectly.
- Make sure that the HDD is connected to the HDD connector on the backplane.

#### Follow these instructions to install a 3.5" HDD:

1. Press the release button.
2. Extend the locking lever.
3. Pull the locking lever in the direction indicated to remove the HDD tray.
4. Slide the hard disk drive into the HDD tray.
5. Reinsert the HDD tray into the slot and close the locking lever.

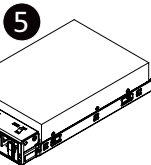
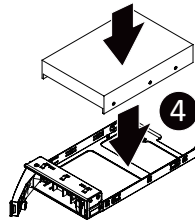
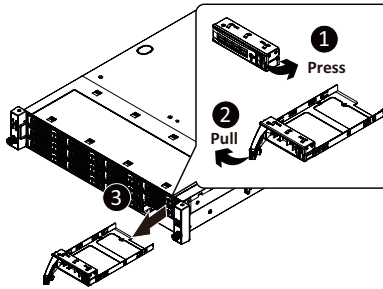

**Follow these instructions to install 2.5" hard disk drive into 3.5" HDD Tray:**

1. Press the release button.
2. Extend the locking lever.
3. Pull the locking lever in the direction indicated to remove the HDD tray.
4. Align the hard disk drive with the positioning screw on the HDD tray.
5. Secure the hard disk drive with five screws.
6. Reinsert the HDD tray into the slot and close the locking lever.

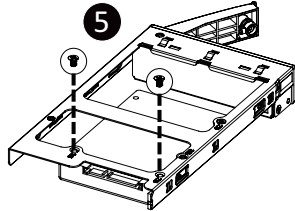
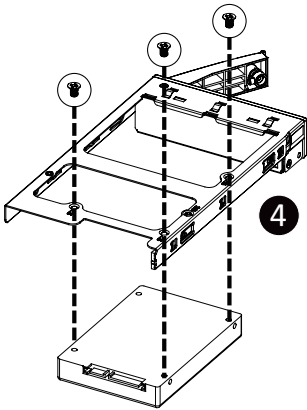
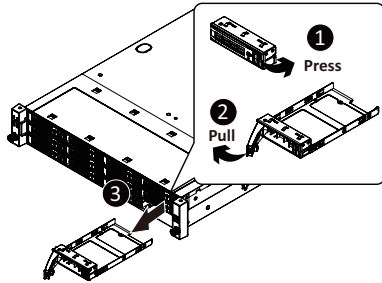

### 3-9 Installing the M.2 Device and Heat Sink



#### CAUTION

The position of the stand-off screw will depend on the size of the M.2 device. Refer to the size of the M.2 device and change the position of the stand-off screw accordingly.



#### WARNING:

Please ensure a heatsink is attached to any M.2 device installed into the system. Installing an M.2 device without any heatsink may result in the system overheating or system performance being throttled.



- To install/remove the M.2 module and Heatsink use a No. 1 Phillips-head screwdriver with a screw torque of  $1.5 \pm 0.2 \text{ kg}^*\text{cm}$

#### Follow these instructions to install the M.2 device and heat sink:

1. Insert the M.2 device into the M.2 connector.
2. Press down on the M.2 device.
3. Install the thermal pad of the M.2 device to the M.2 device.
4. Press down on the thermal pad.
5. Secure the M.2 device and its thermal pad to the motherboard with a single screw.
6. Reverse steps 1-2 to remove the M.2 device.

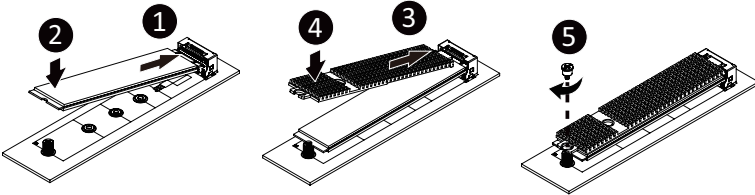

### 3-10 Replacing the Fan Assembly



- Voltages can be present within the server whenever an AC power source is connected. This voltage is present even when the main power switch is in the off position. Ensure that the system is powered-down and all power sources have been disconnected from the server prior to replacing a system fan.
- Failure to observe these warnings could result in personal injury or damage to equipment.

Follow these instructions to replace the fan assembly:

1. Pull outward the fan ear.
2. Lift up the fan assembly from the chassis.
3. Reverse the previous steps to install the replacement fan assembly.

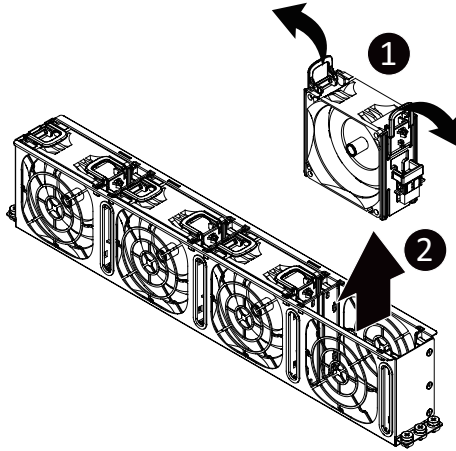

## 3-11 Replacing the Power Supply



### CAUTION!

- In order to reduce the risk of injury from electric shock, disconnect AC power from the power supply before removing the power supply from the system

### Follow these instructions to replace the power supply:

1. Flip and then grasp the power supply handle.
2. Press the retaining clip on the top side of the power supply in the direction indicated.
3. Pull out the power supply using the handle.
4. Insert the replacement power supply firmly into the chassis. Connect the AC power cord to the replacement power supply.

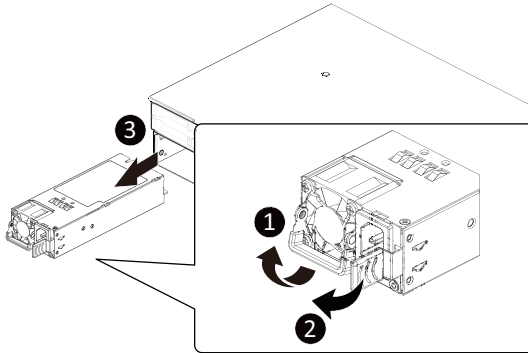

### 3-12 Cable Routing

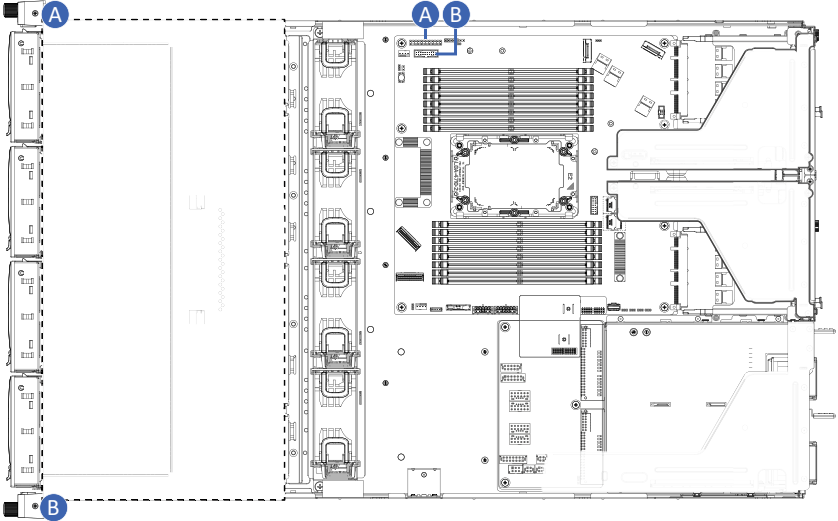

|   |                        |                     |
|---|------------------------|---------------------|
| A | Front Switch/LED Cable | Motherboard: FP_1   |
|   |                        | --                  |
| B | Front USB 3 Cable      | Motherboard: F_USB3 |
|   |                        | --                  |



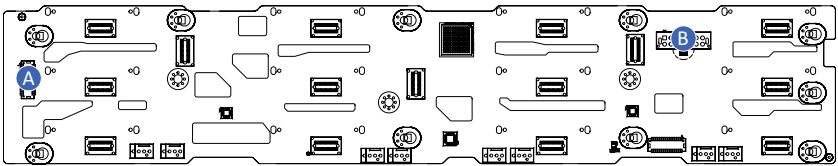
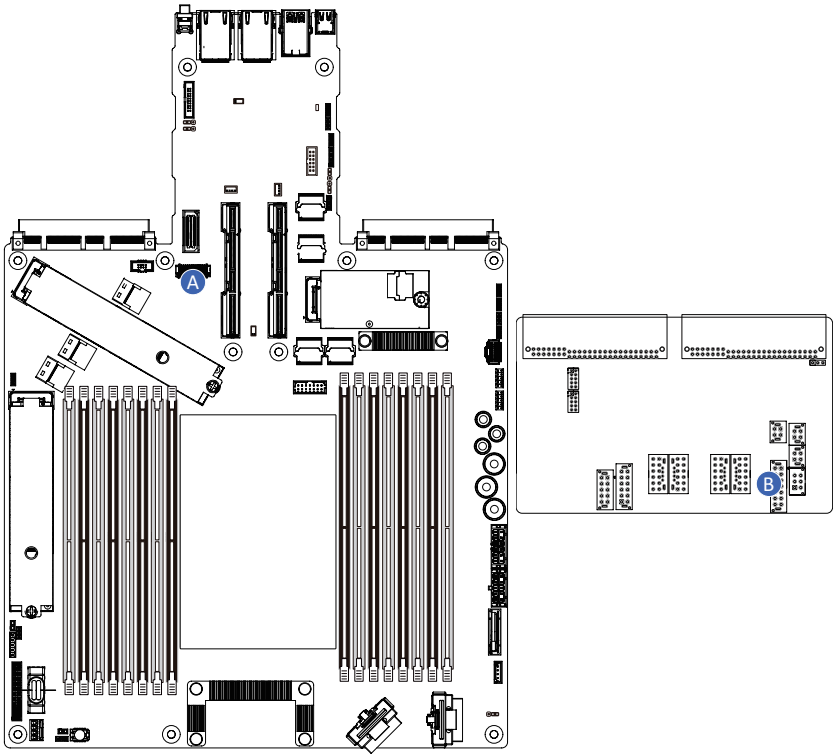

|   |                              |                         |
|---|------------------------------|-------------------------|
| A | Backplane Board Signal Cable | Motherboard: BP_1       |
|   |                              | Backplane Board: BP_1   |
| B | Backplane Board Power Cable  | Power Board: BP_ATX1    |
|   |                              | Backplane Board: BP_2X3 |

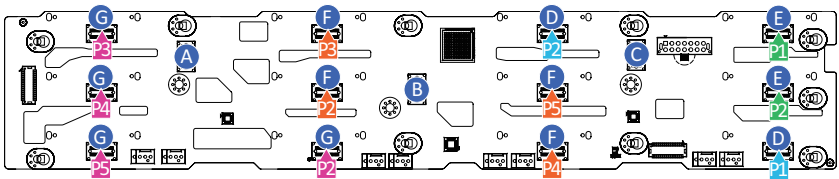
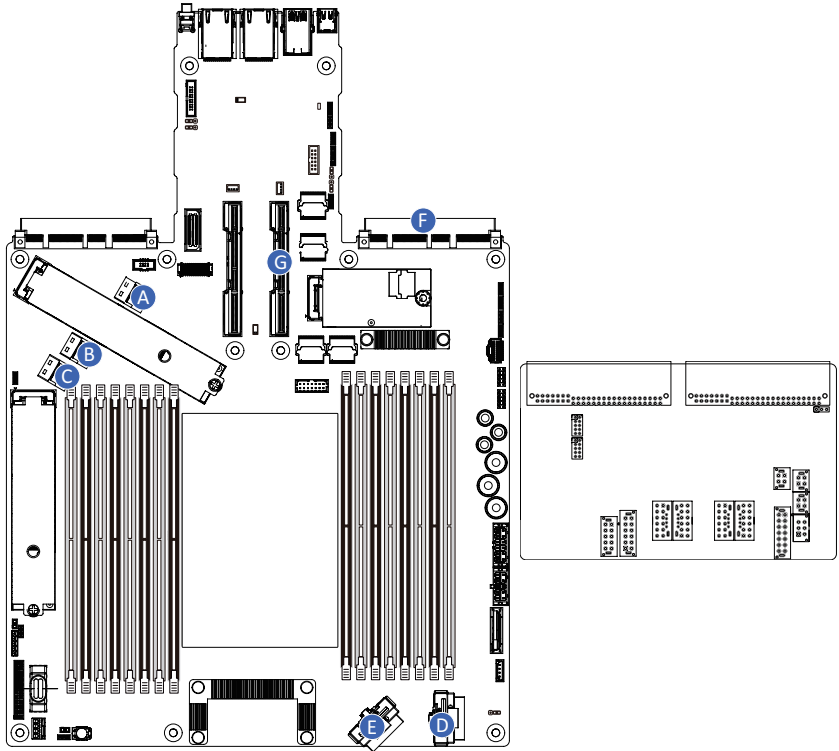

|   |            |                          |                       |
|---|------------|--------------------------|-----------------------|
| A | SATA Cable | Motherboard: SL_SATA1    |                       |
|   |            | Backplane Board: SL_SAS0 |                       |
| B | SATA Cable | Motherboard: SL_SATA2    |                       |
|   |            | Backplane Board: SL_SAS1 |                       |
| C | SATA Cable | Motherboard: SL_SATA3    |                       |
|   |            | Backplane Board: SL_SAS2 |                       |
| D | NVMe Cable | Motherboard              | U2_P0_5CA             |
|   |            | Backplane Board          | U.2_10 (P1)           |
|   |            |                          | U.2_9 (P2)            |
| E | NVMe Cable | Motherboard              | U2.P0_5GE             |
|   |            | Backplane Board          | U.2_12 (P1)           |
|   |            |                          | U.2_11 (P2)           |
| F | MCIO Cable | Motherboard              | OCP 3.0 Connector     |
|   |            | Backplane Board          | U.2_5 (P2)            |
|   |            |                          | U.2_6 (P3)            |
|   |            |                          | U.2_7 (P4)            |
|   |            |                          | U.2_8 (P5)            |
| G | MCIO Cable | Motherboard              | Riser Connector SLOT2 |
|   |            | Backplane Board          | U.2_4 (P2)            |
|   |            |                          | U.2_3 (P3)            |
|   |            |                          | U.2_2 (P4)            |
|   |            |                          | U.2_1 (P5)            |

# Chapter 4 Motherboard Components

## 4-1 Motherboard Components

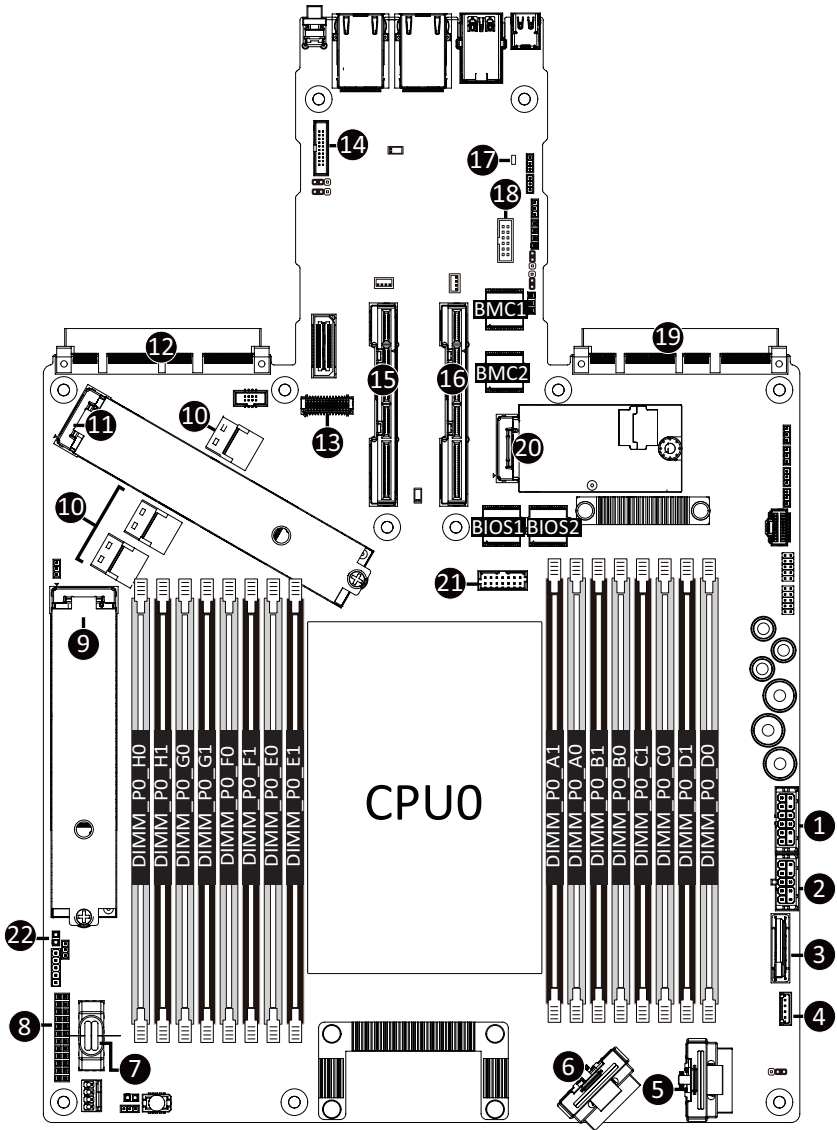

| Item | Description                                     |
|------|---|
| 1    | 2 x 6 Pin ATX Power Connector                   |
| 2    | 2 x 5 Pin ATX Power Connector                   |
| 3    | System Battery                                  |
| 4    | VROC Module Connector                           |
| 5    | MCIO Connector (U2_P0_5CA/PCIe Gen5)            |
| 6    | MCIO Connector (U2_P0_5GE/PCIe Gen5)            |
| 7    | Front Panel USB 3.2 Gen1 Connector              |
| 8    | Front Panel Connector                           |
| 9    | M2M1 (PCIe Gen5 x2, Support NGFF-22110)         |
| 10   | SlimLine Connector (SL_SATA3/SL_SATA2/SL_SATA1) |
| 11   | M2M2 (PCIe Gen5 x2, Support NGFF-22110)         |
| 12   | OCP 3.0 Connector (PCIe Gen5 x16)               |
| 13   | HDD Back Plane Board Connector                  |
| 14   | NCSI Connector for add-on LAN Card (CN_NCSI1)   |
| 15   | Riser Connector #1 (PCIe Gen5/x16 Slot)         |
| 16   | Riser Connector #2 (PCIe Gen5/x16 Slot)         |
| 17   | BMC Firmware Readiness LED                      |
| 18   | DB ESPI Connector                               |
| 19   | OCP 3.0 Connector (PCIe Gen5 x16)               |
| 20   | PRoT Module Connector (PROT Conn.)              |
| 21   | TPM Module Connector (SPI Interface)            |
| 22   | Case Open Intrusion Alert Header                |

# 4-2 Jumper Setting

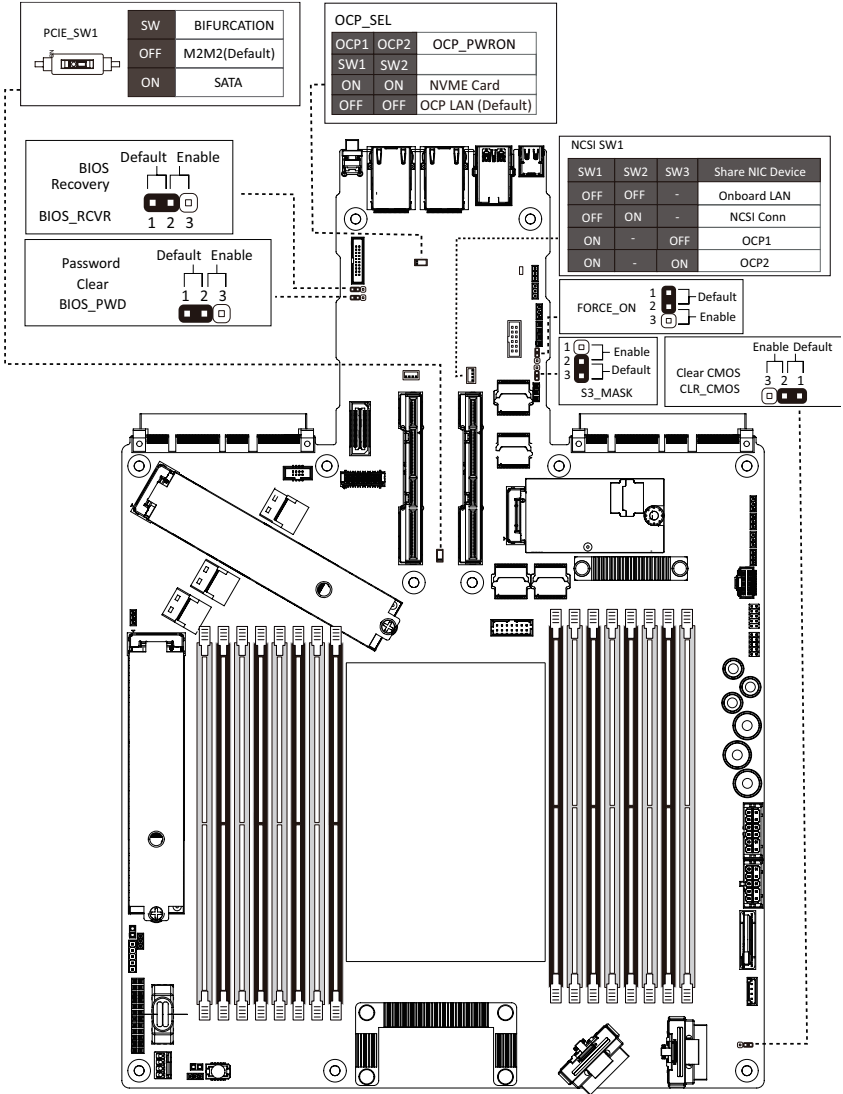

## 4-3 Backplane Board Storage Connector

### 4-3-1 CBP20C5

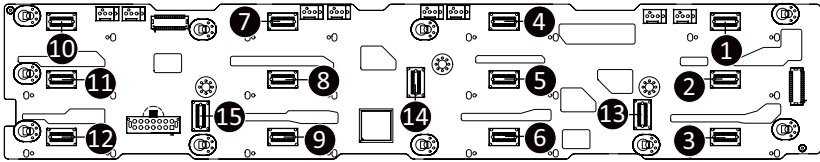

| Item | Description                              |
|------|--|
| 1    | SlimLine Connector (SFF-8654 4i/U_2_0)   |
| 2    | SlimLine Connector (SFF-8654 4i/U_2_1)   |
| 3    | SlimLine Connector (SFF-8654 4i/U_2_2)   |
| 4    | SlimLine Connector (SFF-8654 4i/U_2_3)   |
| 5    | SlimLine Connector (SFF-8654 4i/U_2_4)   |
| 6    | SlimLine Connector (SFF-8654 4i/U_2_5)   |
| 7    | SlimLine Connector (SFF-8654 4i/U_2_6)   |
| 8    | SlimLine Connector (SFF-8654 4i/U_2_7)   |
| 9    | SlimLine Connector (SFF-8654 4i/U_2_8)   |
| 10   | SlimLine Connector (SFF-8654 4i/U_2_9)   |
| 11   | SlimLine Connector (SFF-8654 4i/U_2_10)  |
| 12   | SlimLine Connector (SFF-8654 4i/U_2_11)  |
| 13   | SlimLine Connector (SFF-8654 4i/SL_SAS0) |
| 14   | SlimLine Connector (SFF-8654 4i/SL_SAS1) |
| 15   | SlimLine Connector (SFF-8654 4i/SL_SAS2) |

## Chapter 5 BIOS Setup

BIOS (Basic Input and Output System) records hardware parameters of the system in the EFI on the motherboard. Its major functions include conducting the Power-On Self-Test (POST) during system startup, saving system parameters, loading the operating system etc. The BIOS includes a BIOS Setup program that allows the user to modify basic system configuration settings or to activate certain system features. When the power is turned off, the battery on the motherboard supplies the necessary power to the CMOS to keep the configuration values in the CMOS.

To access the BIOS Setup program, press the <DEL> key during the POST when the power is turned on.



- BIOS flashing is potentially risky, if you do not encounter any problems when using the current BIOS version, it is recommended that you don't flash the BIOS. To flash the BIOS, do it with caution. Inadequate BIOS flashing may result in system malfunction.
- It is recommended that you not alter the default settings (unless you need to) to prevent system instability or other unexpected results. Inadequately altering the settings may result in system's failure to boot. If this occurs, try to clear the CMOS values and reset the board to default values. (Refer to the **Exit** section in this chapter or introductions of the battery/clearing CMOS jumper in Chapter 4 for how to clear the CMOS values.)

### BIOS Setup Program Function Keys

|          |  |
|----------|--|
| <<-><->> | Move the selection bar to select the screen                              |
| <↑><↓>   | Move the selection bar to select an item                                 |
| <+>      | Increase the numeric value or make changes                               |
| <->      | Decrease the numeric value or make changes                               |
| <Enter>  | Execute command or enter the submenu                                     |
| <Esc>    | Main Menu: Exit the BIOS Setup program<br>Submenus: Exit current submenu |
| <F1>     | Show descriptions of general help  |
| <F3>     | Restore the previous BIOS settings for the current submenus              |
| <F9>     | Load the Optimized BIOS default settings for the current submenus        |
| <F10>    | Save all the changes and exit the BIOS Setup program                     |



■ **Main**

This setup page includes all the items of the standard compatible BIOS.

■ **Advanced**

This setup page includes all the items of AMI BIOS special enhanced features.

(ex: Auto detect fan and temperature status, automatically configure hard disk parameters.)

■ **Chipset**

This setup page includes all the submenu options for configuring the functions of the Platform Controller Hub.

■ **Server Management**

Server additional features enabled/disabled setup menus.

■ **Security**

Change, set, or disable supervisor and user password. Configuration supervisor password allows you to restrict access to the system and BIOS Setup.

A supervisor password allows you to make changes in BIOS Setup.

A user password only allows you to view the BIOS settings but not to make changes.

■ **Boot**

This setup page provides items for configuration of the boot sequence.

■ **Save & Exit**

Save all the changes made in the BIOS Setup program to the CMOS and exit BIOS Setup. (Pressing <F10> can also carry out this task.)

Abandon all changes and the previous settings remain in effect. Pressing <Y> to the confirmation message will exit BIOS Setup. (Pressing <Esc> can also carry out this task.)

# 5-1 The Main Menu

Once you enter the BIOS Setup program, the Main Menu (as shown below) appears on the screen. Use arrow keys to move among the items and press <Enter> to accept or enter other sub-menu.

## Main Menu Help

The on-screen description of a highlighted setup option is displayed on the bottom line of the Main Menu.

## Submenu Help

While in a submenu, press <F1> to display a help screen (General Help) of function keys available for the menu. Press <Esc> to exit the help screen. Help for each item is in the Item Help block on the right side of the submenu.



- When the system is not stable as usual, select the **Restore Defaults** item to set your system to its defaults.
- The BIOS Setup menus described in this chapter are for reference only and may differ by BIOS version.

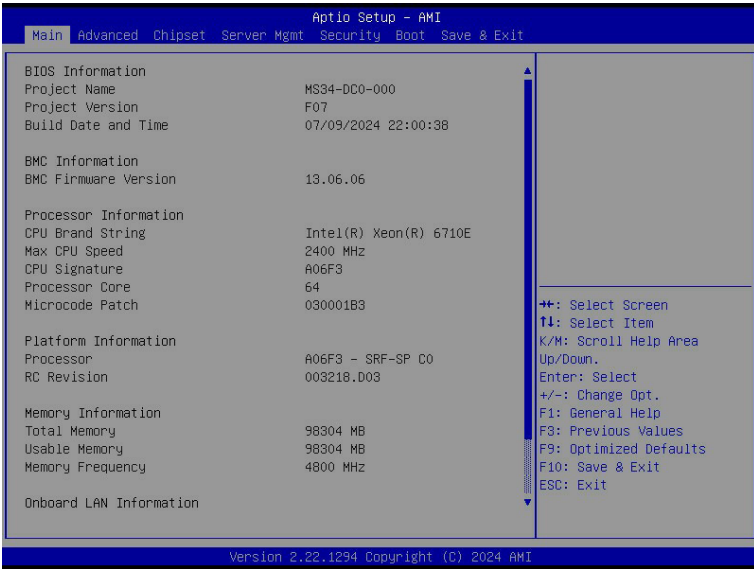

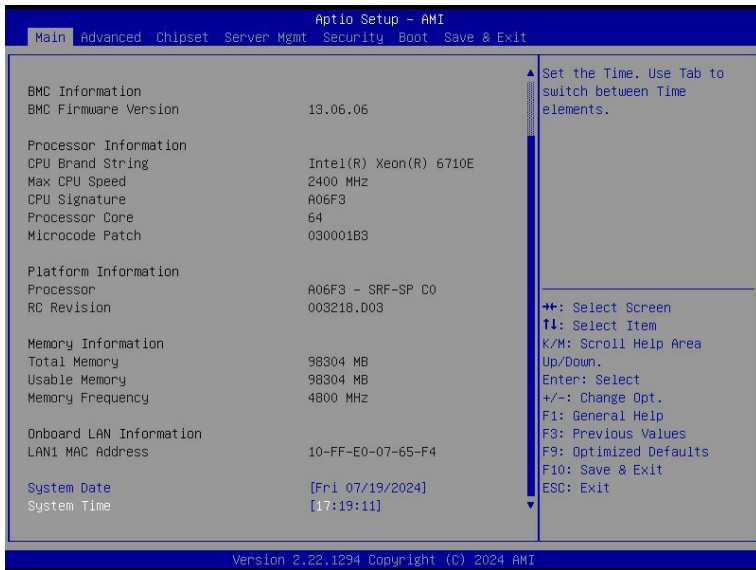

| Parameter  | Description   |
|--|---|
| <b>BIOS Information</b>  |   |
| Project Name   | Displays the project name information.                              |
| Project Version  | Displays version number of the BIOS setup utility.                  |
| Build Date and Time  | Displays the date and time when the BIOS setup utility was created. |
| <b>BMC Information<sup>(Note1)</sup></b>   |   |
| BMC Firmware Version <sup>(Note1)</sup>  | Displays BMC firmware version information.                          |
| <b>Processor Information</b>   |   |
| CPU Brand String/ Max CPU Speed<br>/ CPU Signature / Processor Core /<br>Microcode Patch | Displays the technical information for the installed processor(s).  |
| <b>Platform Information</b>  |   |
| Processor/ PCH/ RC Revision  | Displays the information of the installed processor(s) and PCH.     |
| <b>Memory Information<sup>(Note2)</sup></b>  |   |
| Total Memory   | Displays the total memory size of the installed memory.             |
| Usable Memory  | Displays the usable memory size of the installed memory.            |

(Note1) Functions available on selected models.

(Note2) This section will display capacity and frequency information of the memory that the customer has installed.

| <b>Parameter</b>                           | <b>Description</b>  |
|--|---|
| Memory Frequency                           | Displays the frequency information of the installed memory.   |
| Onboard LAN Information <sup>(Note3)</sup> |   |
| LAN# MAC Address                           | Displays LAN MAC address information.                         |
| System Date                                | Sets the date following the weekday-month-day-year format.    |
| System Time                                | Sets the system time following the hour-minute-second format. |

(Note3) The number of LAN ports listed will depend on the motherboard / system model.

## 5-2 Advanced Menu

The Advanced Menu displays submenu options for configuring the function of various hardware components. Select a submenu item, then press <Enter> to access the related submenu screen.

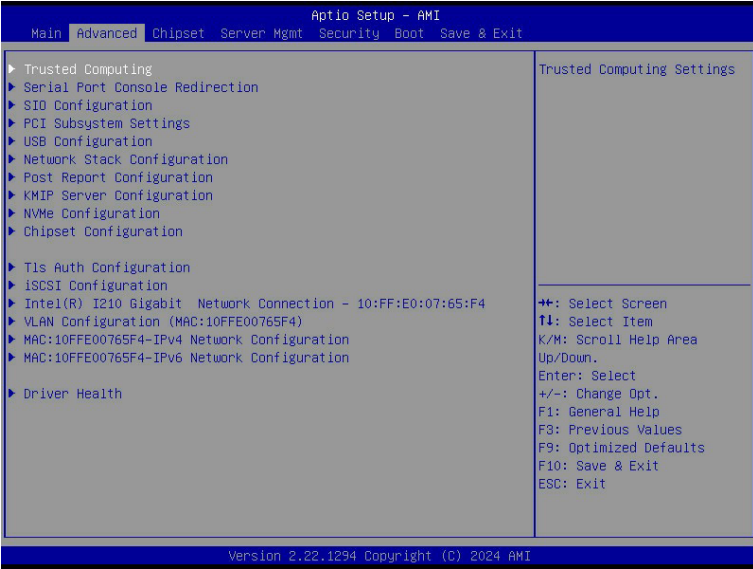

## 5-2-1 Trusted Computing

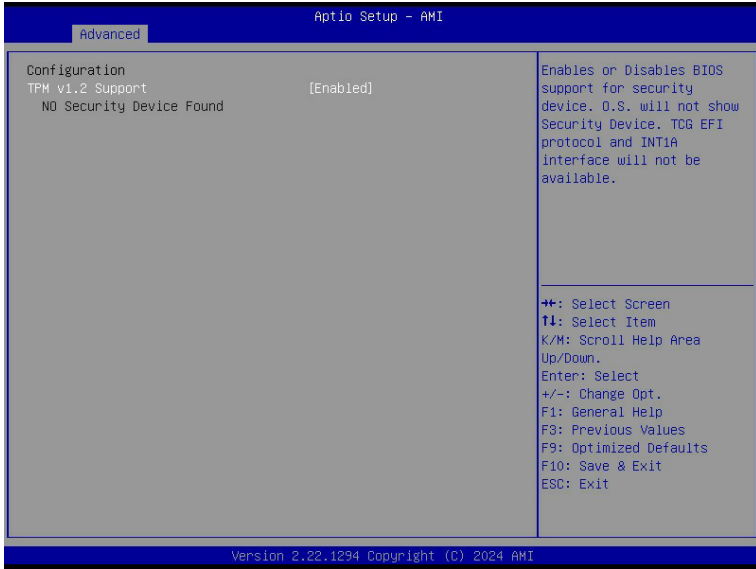

| Parameter        | Description  |
|------------------|--|
| Configuration    |  |
| TPM v1.2 Support | <p>Enable/Disable BIOS support for security device. OS will not show security device. TCG EFI protocol and INT1A interface will not be available.</p> <p>Options available: Disable, Enable. Default setting is <b>Enable</b>.</p> |

## 5-2-2 Serial Port Console Redirection

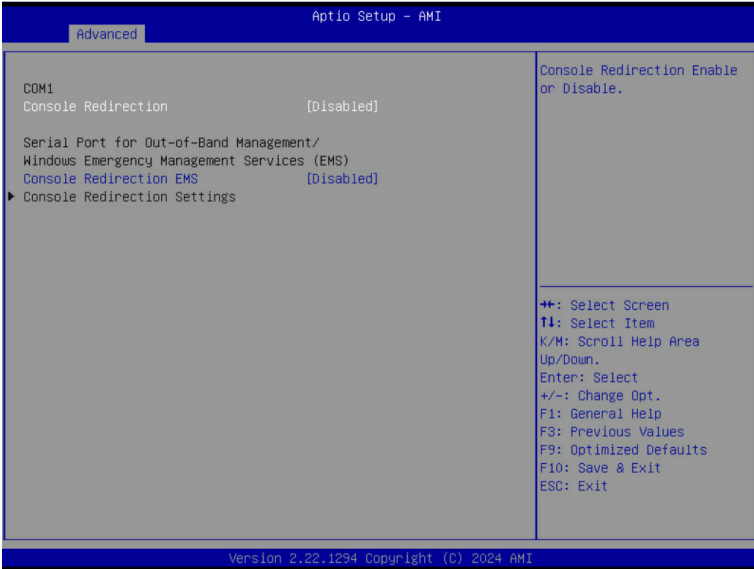

| Parameter                                  | Description   |
|--|---|
| COM1 Console Redirection <sup>(Note)</sup> | <p>Console redirection enables the users to manage the system from a remote location.</p> <p>Options available: Enabled, Disabled. Default setting is <b>Disabled</b>.</p>  |
| COM1 Console Redirection Settings          | <p>Press [Enter] to configure advanced items.</p> <p><b>Please note that this item is configurable when COM1 Console Redirection is set to Enabled.</b></p> <ul style="list-style-type: none"> <li>◆ Terminal Type <ul style="list-style-type: none"> <li>– Selects a terminal type to be used for console redirection.</li> <li>– Options available: VT100, VT100PLUS, VT-UTF8, ANSI. Default setting is <b>VT100PLUS</b>.</li> </ul> </li> <li>◆ Bits per second <ul style="list-style-type: none"> <li>– Selects the transfer rate for console redirection.</li> <li>– Options available: 9600, 19200, 38400, 57600, 115200. Default setting is <b>115200</b>.</li> </ul> </li> <li>◆ Data Bits <ul style="list-style-type: none"> <li>– Selects the number of data bits used for console redirection.</li> <li>– Options available: 7, 8. Default setting is <b>8</b>.</li> </ul> </li> </ul> |

(Note) Advanced items prompt when this item is defined.

| Parameter                                     | Description   |
|---|---|
| COM1 Console Redirection Settings (continued) | <ul style="list-style-type: none"> <li>◆ Parity <ul style="list-style-type: none"> <li>– A parity bit can be sent with the data bits to detect some transmission errors.</li> <li>– Even: parity bit is 0 if the num of 1's in the data bits is even.</li> <li>– Odd: parity bit is 0 if num of 1's in the data bits is odd.</li> <li>– Mark: parity bit is always 1. Space: Parity bit is always 0.</li> <li>– Mark and Space Parity do not allow for error detection.</li> <li>– Options available: None, Even, Odd, Mark, Space. Default setting is <b>None</b>.</li> </ul> </li> <li>◆ Stop Bits <ul style="list-style-type: none"> <li>– Stop bits indicate the end of a serial data packet. (A start bit indicates the beginning). The standard setting is 1 stop bit. Communication with slow devices may require more than 1 stop bit.</li> <li>– Options available: 1, 2. Default setting is <b>1</b>.</li> </ul> </li> <li>◆ Flow Control <ul style="list-style-type: none"> <li>– Flow control can prevent data loss from buffer overflow. When sending data, if the receiving buffers are full, a 'stop' signal can be sent to stop the data flow. Once the buffers are empty, a 'start' signal can be sent to re-start the flow. Hardware flow control uses two wires to send start/stop signals.</li> <li>– Options available: None, Hardware RTS/CTS. Default setting is <b>None</b>.</li> </ul> </li> <li>◆ VT-UTF8 Combo Key Support <ul style="list-style-type: none"> <li>– Enable/Disable the VT-UTF8 Combo Key Support.</li> <li>– Options available: Enabled, Disabled. Default setting is <b>Enabled</b>.</li> </ul> </li> <li>◆ Recorder Mode <ul style="list-style-type: none"> <li>– When this mode enabled, only texts will be send. This is to capture Terminal data.</li> <li>– Options available: Enabled, Disabled. Default setting is <b>Disabled</b>.</li> </ul> </li> <li>◆ Resolution 100x31 <ul style="list-style-type: none"> <li>– Enable/Disable extended terminal resolution.</li> <li>– Options available: Enabled, Disabled. Default setting is <b>Enabled</b>.</li> </ul> </li> <li>◆ Putty Keypad <ul style="list-style-type: none"> <li>– Selects Function Key and Keypad on Putty.</li> <li>– Options available: VT100, LINUX, XTERMR6, SC0, ESCN, VT400. Default setting is <b>VT100</b>.</li> </ul> </li> </ul> |



| Parameter  | Description  |
|--|--|
| Serial Port for Out-of-Band Management / Windows Emergency Management Services (EMS) Console Redirection <sup>(Note)</sup> | <p>EMS console redirection allows the user to configure Console Redirection Settings to support Out-of-Band Serial Port management.</p> <p>Options available: Enabled, Disabled. Default setting is <b>Disabled</b>.</p>   |
| Serial Port for Out-of-Band EMS Console Redirection Settings   | <p>Press [Enter] to configure advanced items.</p> <p><b>Please note that this item is configurable when Serial Port for Out-of-Band Management EMS Console Redirection is set to Enabled.</b></p> <ul style="list-style-type: none"> <li>◆ Out-of-Band Mgmt Port <ul style="list-style-type: none"> <li>– Microsoft Windows Emergency Management Service (EMS) allows for remote management of a Windows Server OS through a serial port.</li> <li>– Default setting is <b>COM1</b>.</li> </ul> </li> <li>◆ Terminal Type EMS <ul style="list-style-type: none"> <li>– Selects a terminal type to be used for console redirection.</li> <li>– Options available: VT100, VT100PLUS, VT-UTF8, ANSI. Default setting is <b>VT100PLUS</b>.</li> </ul> </li> <li>◆ Bits per second EMS <ul style="list-style-type: none"> <li>– Selects the transfer rate for console redirection.</li> <li>– Options available: 9600, 19200, 57600, 115200. Default setting is <b>115200</b>.</li> </ul> </li> <li>◆ Flow Control EMS <ul style="list-style-type: none"> <li>– Flow control can prevent data loss from buffer overflow. When sending data, if the receiving buffers are full, a 'stop' signal can be sent to stop the data flow. Once the buffers are empty, a 'start' signal can be sent to re-start the flow. Hardware flow control uses two wires to send start/stop signals.</li> <li>– Options available: None, Hardware RTS/CTS, Software Xon/Xoff. Default setting is <b>None</b>.</li> </ul> </li> </ul> |

## 5-2-3 SIO Configuration

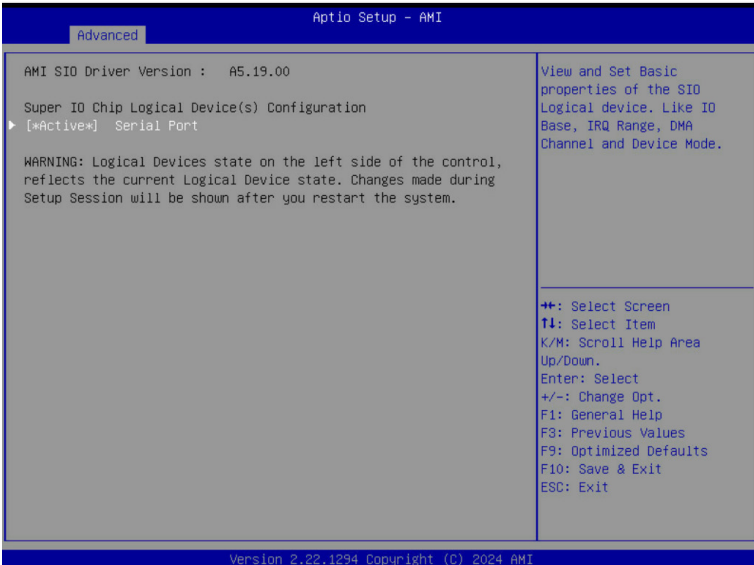

| Parameter                                     | Description   |
|---|---|
| AMI SIO Driver Version                        | Displays the AMI SIO driver version information.  |
| Super IO Chip Logical Device(s) Configuration | Press [Enter] to configure advanced items.  |
| [*Active*] Serial Port                        | <ul style="list-style-type: none"> <li>◆ Use This Device                             <ul style="list-style-type: none"> <li>– When set to Enabled allows you to configure the serial port settings. When set to Disabled, displays no configuration for the serial port.</li> <li>– Options available: Enabled, Disabled. Default setting is <b>Enabled</b>.</li> </ul> </li> <li>◆ Logical Device Settings/Current:                             <ul style="list-style-type: none"> <li>– Displays the serial port base I/O address and IRQ.</li> </ul> </li> <li>◆ Possible:                             <ul style="list-style-type: none"> <li>– Configures the serial port base I/O address and IRQ.</li> <li>Use Automatic Settings</li> <li>IO=3F8h; IRQ=4; DMA;</li> <li>IO=3F8h; IRQ=4; DMA;</li> <li>IO=2F8h; IRQ=4; DMA;</li> <li>IO=3E8h; IRQ=4; DMA;</li> <li>IO=2E8h; IRQ=4; DMA;</li> <li>Default setting is <b>Use Automatic Settings</b>.</li> </ul> </li> </ul> |

## 5-2-4 PCI Subsystem Settings

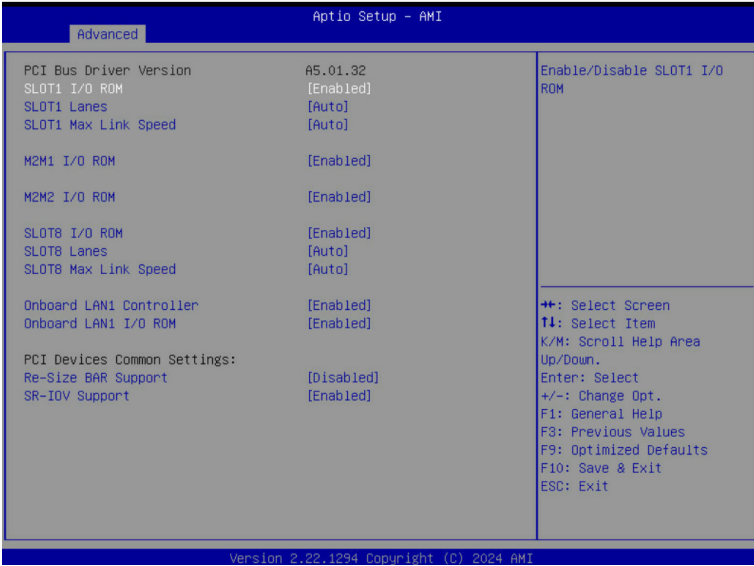

| Parameter                               | Description  |
|---|--|
| PCI Bus Driver Version                  | Displays the PCI Bus Driver version information.   |
| OCP# I/O ROM <sup>(Note1)</sup>         | When enabled, this setting will initialize the device expansion ROM for the related PCI-E slot.<br>Options available: Enabled, Disabled. Default setting is <b>Enabled</b> . |
| OCP# Lanes <sup>(Note1)</sup>           | Change the PCIe lanes. Default setting is <b>Auto</b> .  |
| OCP# Max Link Speed <sup>(Note1)</sup>  | Configure PCIe max link speed.<br>Options available: Auto, Gen1, Gen2, Gen3, Gen4, Gen5.<br>Default setting is <b>Auto</b> .   |
| SLOT# I/O ROM <sup>(Note2)</sup>        | When enabled, this setting will initialize the device expansion ROM for the related PCI-E slot.<br>Options available: Enabled, Disabled. Default setting is <b>Enabled</b> . |
| SLOT# Lanes <sup>(Note2)</sup>          | Change the PCIe lanes. Default setting is <b>Auto</b> .  |
| SLOT# Max Link Speed <sup>(Note2)</sup> | Configure PCIe max link speed.<br>Options available: Auto, Gen1, Gen2, Gen3, Gen4, Gen5.<br>Default setting is <b>Auto</b> .   |

(Note1) This section is dependent on the available OCP Slot.

(Note2) This section is dependent on the available PCIe Slot.

| Parameter  | Description   |
|--|---|
| Onboard LAN1/ LAN2 I/O Controller <sup>(Note3)</sup> | Enable/Disable the onboard LAN controller.<br>Options available: Enabled, Disabled. Default setting is <b>Enabled</b> .   |
| Onboard LAN1 I/O ROM <sup>(Note3)</sup>              | Enable/Disable the onboard LAN devices, and initializes device expansion ROM.<br>Options available: Enabled, Disabled. Default setting is <b>Enabled</b> .                                  |
| PCI Devices Common Settings                          |   |
| Above 4G Decoding                                    | Enable/Disable memory mapped I/O to 4GB or greater address space (Above 4G Decoding).<br>Options available: Enabled, Disabled. Default setting is <b>Enabled</b> .                          |
| SR-IOV Support                                       | If the system has SR-IOV capable PCIe devices, this item Enable/Disable Single Root IO Virtualization Support.<br>Options available: Enabled, Disabled. Default setting is <b>Enabled</b> . |

(Note3) This section is dependent on the available LAN controller.

## 5-2-5 USB Configuration

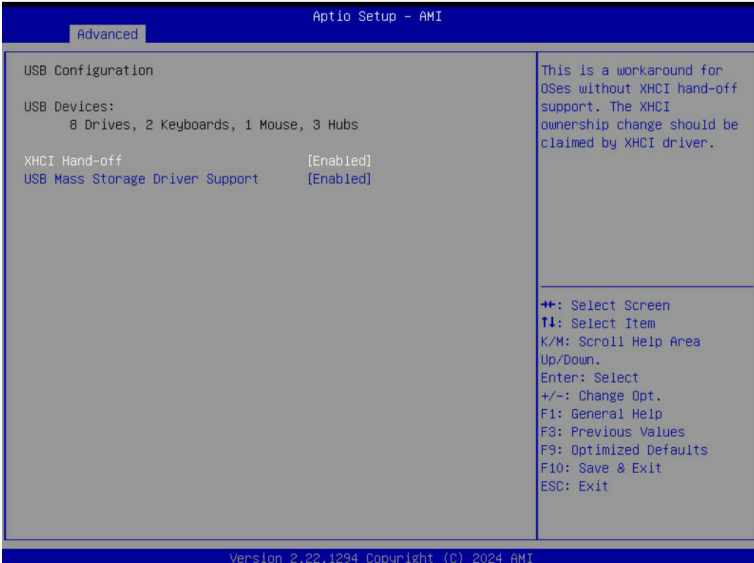

| Parameter   | Description  |
|---|--|
| USB Configuration                                 |  |
| USB Devices:                                      | Displays the USB devices connected to the system.  |
| XHCI Hand-off                                     | Enable/Disable the XHCI (USB 3.0) Hand-off support.<br>Options available: Enabled, Disabled. Default setting is <b>Enabled</b> .   |
| USB Mass Storage Driver Support <sup>(Note)</sup> | Enable/Disable the USB Mass Storage Driver Support.<br>Options available: Enabled, Disabled. Default setting is <b>Enabled</b> .   |
| Port 60/64 Emulation                              | Enables the I/O port 60h/64h emulation support. This should be enabled for the complete USB Keyboard Legacy support for non-USB aware OSes.<br>Options available: Enabled, Disabled. Default setting is <b>Enabled</b> . |

(Note) This item is present only if you attach USB devices.

## 5-2-6 Network Stack Configuration

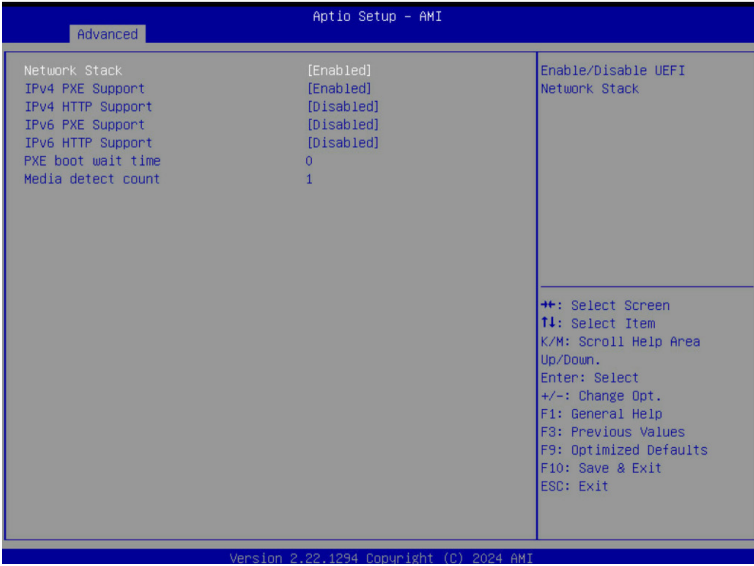

| Parameter          | Description  |
|--------------------|--|
| Network Stack      | Enable/Disable the UEFI network stack.<br>Options available: Enabled, Disabled. Default setting is <b>Enabled</b> .                  |
| Ipv4 PXE Support   | Enable/Disable the Ipv4 PXE feature.<br>Options available: Enabled, Disabled. Default setting is <b>Enabled</b> .                    |
| Ipv4 HTTP Support  | Enable/Disable the Ipv4 HTTP feature.<br>Options available: Enabled, Disabled. Default setting is <b>Disabled</b> .                  |
| Ipv6 PXE Support   | Enable/Disable the Ipv6 PXE feature.<br>Options available: Enabled, Disabled. Default setting is <b>Disabled</b> .                   |
| Ipv6 HTTP Support  | Enable/Disable the Ipv6 HTTP feature.<br>Options available: Enabled, Disabled. Default setting is <b>Disabled</b> .                  |
| PXE boot wait time | Wait time in seconds to press ESC key to abort the PXE boot.<br>Press the <+> / <-> keys to increase or decrease the desired values. |
| Media detect count | Number of times the presence of media will be checked.<br>Press the <+> / <-> keys to increase or decrease the desired values.       |

## 5-2-7 Post Report Configuration

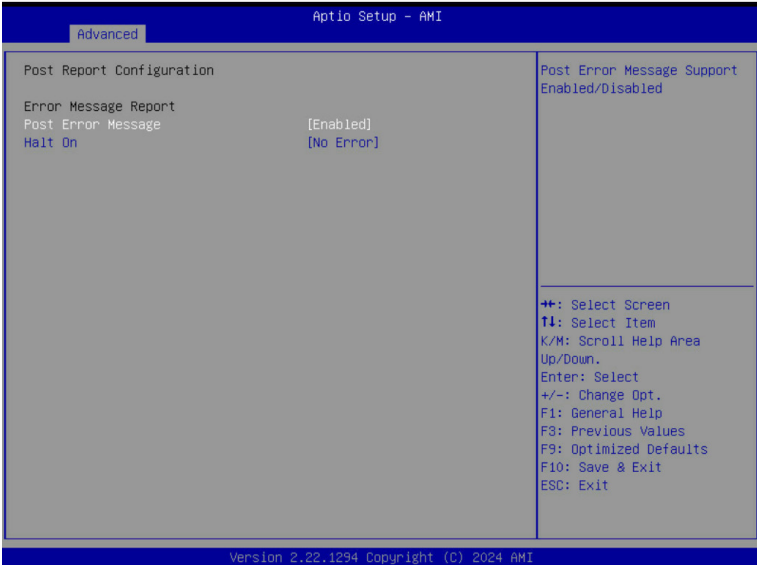

| Parameter                 | Description   |
|---------------------------|---|
| Post Report Configuration |   |
| Error Message Report      |   |
| Post Error Message        | Enable/Disable the POST Error Message support.<br>Options available: Enabled, Disabled. Default setting is <b>Enabled</b> . |
| Halt On                   | Options available: No Error, All Error. Default setting is <b>No Error</b> .  |

# 5-2-8 KMIP Server Configuration

Aptio Setup - AMI

Advanced

|   |  |
|---|--|
| KMIP Server IP address<br>KMIP TCP Port number            5696<br>Time Zone                            [GMT +8]<br><br>Client Credentials                   [Enabled]<br>Client UserName<br>Client Password<br><br>KMS TLS Certificate   Size<br>▶ CA Certificate            0<br>▶ Client Certificate        0<br>▶ Client Private Key       0 | Enter IP4 address in dotted-decimal notation<br>Example: 192.168.10.12 |
| ▶: Select Screen<br>↑: Select Item<br>K/M: Scroll Help Area<br>Up/Down.<br>Enter: Select<br>+/-: Change Opt.<br>F1: General Help<br>F3: Previous Values<br>F9: Optimized Defaults<br>F10: Save & Exit<br>ESC: Exit  |  |

Version 2.22.1294 Copyright (C) 2024 AMI





## 5-2-9 NVMe Configuration



| Parameter          | Description  |
|--------------------|--|
| NVMe Configuration | Displays the NVMe devices connected to the system.                                       |
| NVMe OPROM Select  | Options available: BIOS Build-In, NVMe Device. Default setting is <b>BIOS Build-In</b> . |

## 5-2-10 Chipset Configuration

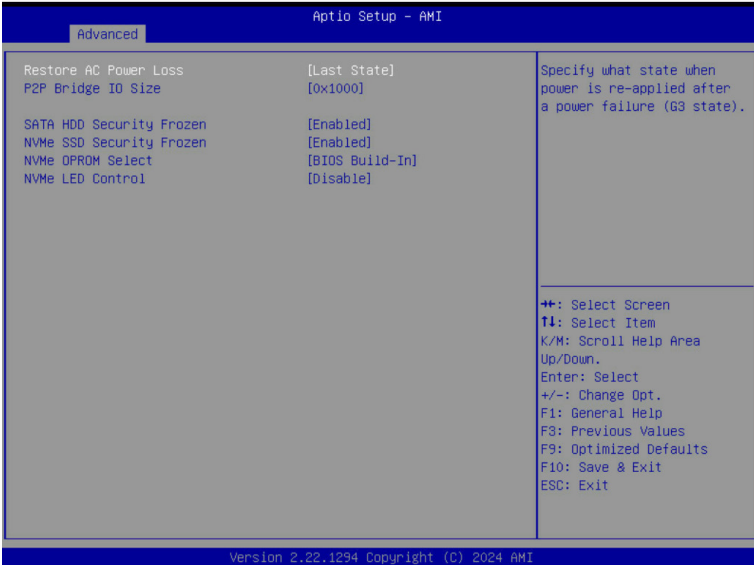

| Parameter                                  | Description   |
|--|---|
| Restore on AC Power Loss <sup>(Note)</sup> | Defines the power state to resume to after a system shutdown that is due to an interruption in AC power. When set to Last State, the system will return to the active power state prior to shutdown. When set to Power Off, the system remains off after power shutdown. Options available: Last State, Power Off, Power On, Unspecified. The default setting depends on the BMC setting. |
| P2P Bridge IO Size                         | Specifies P2P Bridge IO aligned to the size. Options available: 0x100, 0x150, 0x1000. Default setting is <b>0x1000</b> .  |
| SATA HDD Security Frozen                   | Enable/Disable this item to send freeze lock command to SATA HDD. Options available: Enabled, Disabled. Default setting is <b>Enabled</b> .   |
| NVMe SSD Security Frozen                   | Attempt to send freeze lock command to NVMe SSDs during boot. Options available: Enabled, Disabled. Default setting is <b>Enabled</b> .   |
| Chassis Opened Warning                     | Enable/Disable the chassis intrusion alert function. Options available: Enabled, Disabled, Clear. Default setting is <b>Disabled</b> .  |

(Note) When the power policy is controlled by BMC, please wait for 15-20 seconds for BMC to save the last power state.

## 5-2-11 Tls Auth Configuration

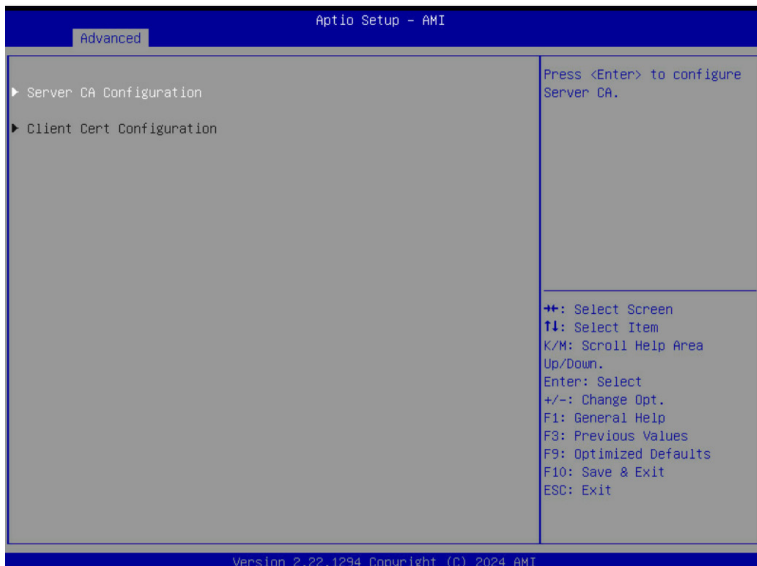

| Parameter                 | Description   |
|---------------------------|---|
| Server CA Configuration   | <p>Press [Enter] for configuration of advanced items.</p> <ul style="list-style-type: none"> <li>◆ Enroll Cert <ul style="list-style-type: none"> <li>- Press [Enter] to enroll a certificate <ul style="list-style-type: none"> <li>• Enroll Cert Using File</li> <li>• Cert GUID <p>Input digit character in 1111111-2222-3333-4444-1234567890ab format.</p> <ul style="list-style-type: none"> <li>- Commit Changes and Exit</li> <li>- Discard Changes and Exit</li> </ul> </li> </ul> </li> </ul> </li> <li>◆ Delete Cert</li> </ul> |
| Client Cert Configuration | <p>Press [Enter] for configuration of advanced items.</p>   |

## 5-2-12 iSCSI Configuration



| Parameter                | Description  |
|--------------------------|--|
| Attempt Priority         | <p>Press [Enter] configure advanced items.</p> <ul style="list-style-type: none"> <li>◆ Attempt Priority <ul style="list-style-type: none"> <li>– Use arrow keys to select the attempt, then press +/- keys to move the attempt up/down in the attempt order list.</li> </ul> </li> <li>◆ Commit Changes and Exit</li> </ul> |
| Host iSCSI Configuration | <p>Press [Enter] to configure advanced items.</p> <ul style="list-style-type: none"> <li>◆ iSCSI Initiator Name <ul style="list-style-type: none"> <li>– Only IQN format is accepted. Range: from 4 to 223</li> </ul> </li> <li>◆ Add an Attempt</li> <li>◆ Delete Attempts</li> <li>◆ Change Attempt Order</li> </ul>       |

## 5-2-13 Intel(R) Ethernet Controller I210

| Advanced   |  | Aptio Setup - AMI   |
|--|--|---|
| <p>▶ NIC Configuration</p> <p>Blink LEDs 0</p> <p>UEFI Driver Intel(R) PRO/1000 8.5.21<br/>PCI-E</p> <p>Adapter PBA 000300-000</p> <p>Device Name Intel(R) I210 Gigabit<br/>Network Connection</p> <p>Chip Type Intel i210</p> <p>PCI Device ID 1533</p> <p>PCI Address 43:00:00</p> <p>Link Status [Disconnected]</p> <p>MAC Address 10:FF:E0:07:65:F4</p> <p>Virtual MAC Address 00:00:00:00:00:00</p> |  | <p>Click to configure the network device port.</p> <hr/> <p>                     ⇧⇩: Select Screen<br/>                     ⇧⇩: Select Item<br/>                     K/M: Scroll Help Area Up/Down.<br/>                     Enter: Select<br/>                     +/-: Change Opt.<br/>                     F1: General Help<br/>                     F8: Previous Values<br/>                     F9: Optimized Defaults<br/>                     F10: Save &amp; Exit<br/>                     ESC: Exit                 </p> |
| Version 2.22.1294 Copyright (C) 2024 AMI   |  |   |

| Advanced   |  | Aptio Setup - AMI   |
|--|--|---|
| <p>Link Speed [Auto Negotiated]</p> <p>Wake On LAN [Enabled]</p> |  | <p>Specifies the port speed used for the selected boot protocol.</p> <hr/> <p>                     ⇧⇩: Select Screen<br/>                     ⇧⇩: Select Item<br/>                     K/M: Scroll Help Area Up/Down.<br/>                     Enter: Select<br/>                     +/-: Change Opt.<br/>                     F1: General Help<br/>                     F8: Previous Values<br/>                     F9: Optimized Defaults<br/>                     F10: Save &amp; Exit<br/>                     ESC: Exit                 </p> |
| Version 2.22.1294 Copyright (C) 2024 AMI                         |  |   |

| Parameter           | Description   |
|---------------------|---|
| NIC Configuration   | <p>Press [Enter] to configure advanced items.</p> <ul style="list-style-type: none"> <li>◆ Link Speed <ul style="list-style-type: none"> <li>– Allows for automatic link speed adjustment.</li> <li>– Options available: Auto Negotiated, 10 Mbps Half, 10 Mbps Full, 100 Mbps Half, 100 Mbps Full. Default setting is <b>Auto Negotiated</b>.</li> </ul> </li> <li>◆ Wake On LAN <ul style="list-style-type: none"> <li>– Enables power on of the system via LAN. Note that configuring Wake on LAN in the operating system does not change the value of this setting, but does override the behavior of Wake on LAN in OS controlled power states.</li> <li>– Options available: Enabled, Disabled. Default setting is <b>Enabled</b>.</li> </ul> </li> </ul> |
| Blink LEDs          | <p>Identifies the physical network port by blinking the associated LED.<br/>Press the numeric keys to adjust desired values (up to 15 seconds).</p>   |
| UEFI Driver         | Displays the technical specifications for the Network Interface Controller.   |
| Adapter PBA         | Displays the technical specifications for the Network Interface Controller.   |
| Device Name         | Displays the technical specifications for the Network Interface Controller.   |
| Chip Type           | Displays the technical specifications for the Network Interface Controller.   |
| PCI Device ID       | Displays the technical specifications for the Network Interface Controller.   |
| PCI Address         | Displays the technical specifications for the Network Interface Controller.   |
| Link Status         | Displays the technical specifications for the Network Interface Controller.   |
| MAC Address         | Displays the technical specifications for the Network Interface Controller.   |
| Virtual MAC Address | Displays the technical specifications for the Network Interface Controller.   |

## 5-2-14 VLAN Configuration

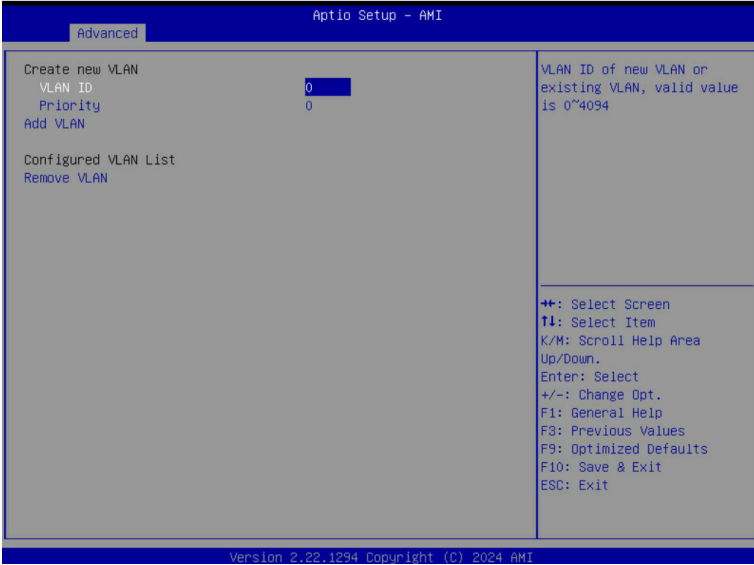

| Parameter                | Description   |
|--------------------------|---|
| Enter Configuration Menu | <p>Press [Enter] to configure advanced items.</p> <ul style="list-style-type: none"> <li>◆ Create new VLAN</li> <li>◆ VLAN ID <ul style="list-style-type: none"> <li>– Sets VLAN ID for a new VLAN or an existing VLAN.</li> <li>– Press the &lt;+&gt; / &lt;-&gt; keys to increase or decrease the desired values.</li> <li>– The valid range is from 0 to 4094.</li> </ul> </li> <li>◆ Priority <ul style="list-style-type: none"> <li>– Sets 802.1Q Priority for a new VLAN or an existing VLAN.</li> <li>– Press the &lt;+&gt; / &lt;-&gt; keys to increase or decrease the desired values.</li> <li>– The valid range is from 0 to 7.</li> </ul> </li> <li>◆ Add VLAN <ul style="list-style-type: none"> <li>– Press [Enter] to create a new VLAN or update an existing VLAN.</li> </ul> </li> <li>◆ Configured VLAN List</li> <li>◆ Remove VLAN <ul style="list-style-type: none"> <li>– Press [Enter] to remove an existing VLAN.</li> </ul> </li> </ul> |



## 5-2-15 Driver Health

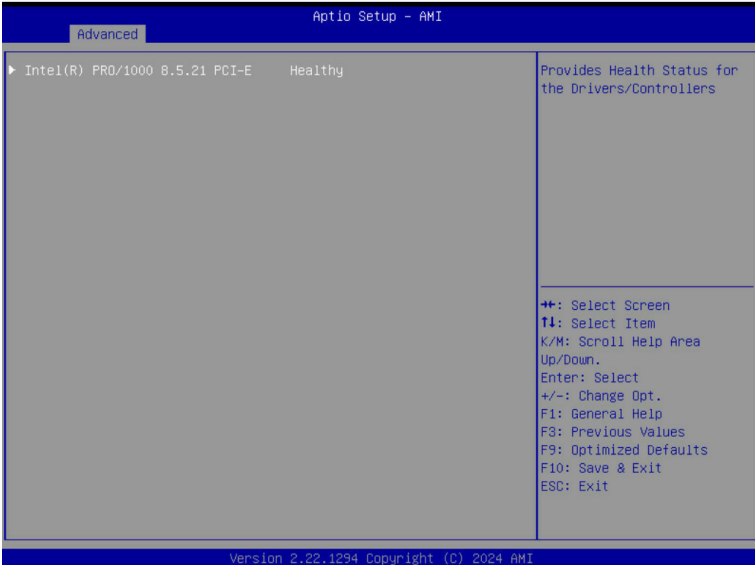

| Parameter     | Description   |
|---------------|---|
| Driver Health | Displays driver health status of the devices/controllers if installed |

# 5-3 Chipset Menu

Chipset Setup menu displays submenu options for configuring the function of Platform Controller Hub(PCH). Select a submenu item, then press <Enter> to access the related submenu screen.

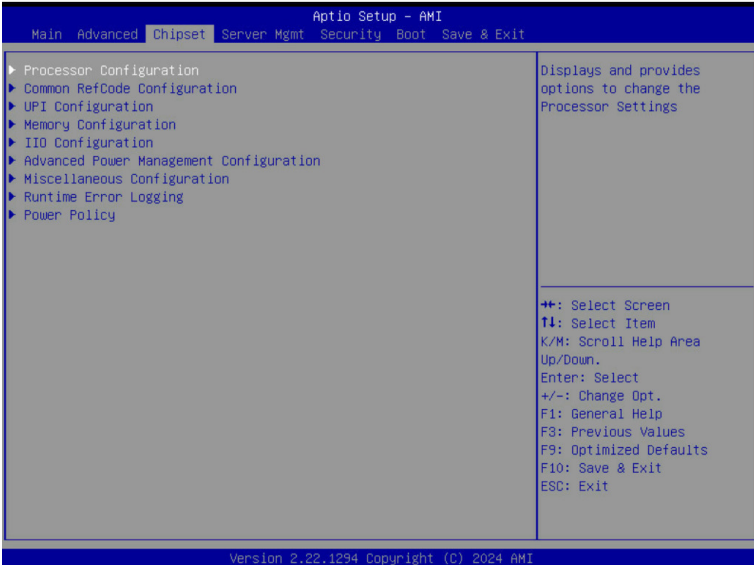

# 5-3-1 Processor Configuration

Aptio Setup - AMI

Chipset

|  |                        |  |
|--|------------------------|--|
| Processor Configuration                  |                        | Change Per-Socket Settings   |
| -----                                    |                        |  |
| ▶ Per-Socket Configuration               |                        |  |
| Processor Socket                         | Socket 0               |  |
| Processor ID                             | 000A06F3*              | N/A  |
| Processor Frequency                      | 2.400GHz               | N/A  |
| Processor Max Ratio                      | 19H                    | N/A  |
| Processor Min Ratio                      | 09H                    | N/A  |
| Microcode Revision                       | 030001B3               | N/A  |
| L1 Cache RAM(Per Core)                   | 96KB                   | N/A  |
| L2 Cache RAM(Per Package)                | 65536KB                | N/A  |
| L3 Cache RAM(Per Package)                | 98304KB                | N/A  |
| Processor 0 Version                      | Intel(R) Xeon(R) 6710E |  |
| -----                                    |                        |  |
| Hardware Prefetcher                      | [Enable]               |  |
| Adjacent Cache Prefetch                  | [Enable]               |  |
| DCU Streamer Prefetcher                  | [Auto]                 |  |
| DCU IP Prefetcher                        | [Enable]               |  |
| L1 Next Page Prefetcher                  | [Enable]               |  |
| Enable Intel(R) TXT                      | [Disable]              |  |
| VMX                                      | [Enable]               |  |
| Enable SMX                               | [Disable]              |  |
| AES-NI                                   | [Enable]               |  |
| Debug Consent                            | [Disable]              |  |
| -----                                    |                        |  |
|  |                        | ++: Select Screen<br>T1: Select Item<br>K/M: Scroll Help Area<br>Up/Down.<br>Enter: Select<br>+/-: Change Opt.<br>F1: General Help<br>F3: Previous Values<br>F9: Optimized Defaults<br>F10: Save & Exit<br>ESC: Exit |
| Version 2.22.1294 Copyright (C) 2024 AMI |                        |  |

Aptio Setup - AMI

Chipset

|   |             |  |
|---|-------------|--|
| Processor Reserved Memory [Outputs]   |             | In Field Scan (IFS)  |
| -----   |             |  |
| PRMRR Size per domain   | 16 MiB      |  |
| PRM Size per socket   | 16 MiB      |  |
| PRM Size per system   | 16 MiB      |  |
| -----   |             |  |
| Software Guard Extension (SGX) [Outputs]  |             |  |
| -----   |             |  |
| SGX activation state  | Deactivated |  |
| SGX memory population for SGX enabling is not POR. Please check your memory population. |             |  |
| SGX error code [HEX]  | 16          |  |
| -----   |             |  |
| Software Guard Extension (SGX) [Inputs]   |             |  |
| -----   |             |  |
| SGX Factory Reset   | [Disabled]  |  |
| SW Guard Extensions (SGX)   | [Disabled]  |  |
| SGX Package Info In-Band Access   | [Disabled]  |  |
| SGX PRMRR Size Requested  | [Auto]      |  |
| -----   |             |  |
| In Field Scan (IFS)   |             |  |
| -----   |             |  |
| ▶ In Field Scan (IFS)   |             |  |
| -----   |             |  |
|   |             | ++: Select Screen<br>T1: Select Item<br>K/M: Scroll Help Area<br>Up/Down.<br>Enter: Select<br>+/-: Change Opt.<br>F1: General Help<br>F3: Previous Values<br>F9: Optimized Defaults<br>F10: Save & Exit<br>ESC: Exit |
| Version 2.22.1294 Copyright (C) 2024 AMI  |             |  |

| Parameter   | Description  |
|---|--|
| Processor Configuration   |  |
| Pre-Socket Configuration  | <p>Press [Enter] to configure advanced items.</p> <ul style="list-style-type: none"> <li>◆ CPU Socket 0 Configuration <ul style="list-style-type: none"> <li>– Core Disable Bitmap(Hex) <ul style="list-style-type: none"> <li>• Number of Cores to enable. 0 means all cores. FFFFFFFF means to disable all cores. The maximum value depends on the number of CPUs available. Press the numeric keys to adjust desired values.</li> </ul> </li> </ul> </li> </ul> |
| Processor Socket / Processor ID / Processor Die Type / Processor Frequency / Processor Max Ratio / Processor Min Ratio / Microcode Revision / L1 Cache RAM(Per Core) / L2 Cache RAM(Per Core) / L3 Cache RAM(Per Package) / Processor # Version | Displays the technical specifications for the installed processor(s).  |
| Enable LP [Global]  | <p>Enables Logical processor (Software Method to Enable/Disable Logical Processor threads).</p> <p>Options available: ALL LPs, Single LP. Default setting is <b>ALL LPs</b>.</p>   |
| Hardware Prefetcher   | <p>Select whether to enable the speculative prefetch unit of the processor.</p> <p>Options available: Enable, Disable. Default setting is <b>Enable</b>.</p>   |
| L2 RF0 Prefetch Disable   | Options available: Enable, Disable. Default setting is <b>Disable</b> .  |
| Adjacent Cache Prefetch   | <p>When enabled, cache lines are fetched in pairs. When disabled, only the required cache line is fetched.</p> <p>Options available: Enable, Disable. Default setting is <b>Enable</b>.</p>  |
| DCU Streamer Prefetcher   | <p>Enable/Disable DCU streamer prefetcher.</p> <p>Options available: Enable, Disable. Default setting is <b>Enable</b>.</p>  |
| DCU IP Prefetcher   | <p>Enable/Disable DCU IP Prefetcher.</p> <p>Options available: Enable, Disable. Default setting is <b>Enable</b>.</p>  |
| Extended APIC   | <p>Enable/Disable extended APIC support. Note: The VT-d will be enabled automatically when x2APIC is enabled.</p> <p>Options available: Enable, Disable. Default setting is <b>Enable</b>.</p>   |
| Enable Intel(R) TXT   | <p>Enable/Disable the Intel Trusted Execution Technology support function.</p> <p>Options available: Enable, Disable. Default setting is <b>Disable</b>.</p>   |
| VMX   | <p>Enable/Disable the Vanderpool Technology. This will take effect after rebooting the system.</p> <p>Options available: Enable, Disable. Default setting is <b>Enable</b>.</p>  |
| Enable SMX  | <p>Enable/Disable the Safer Mode Extensions (SMX) support function.</p> <p>Options available: Enable, Disable. Default setting is <b>Disable</b>.</p>  |
| AES-NI  | <p>Enable/Disable the AES-NI support.</p> <p>Options available: Enable, Disable. Default setting is <b>Enable</b>.</p>   |
| Debug Consent   | Options available: Enable, Disable. Default setting is <b>Disable</b> .  |

| Parameter                                     | Description  |
|---|--|
| Memory Encryption (TME) <sup>(Note)</sup>     | Enable/Disable memory encryption (TME).<br>Options available: Enabled, Disabled. Default setting is <b>Disabled</b> .  |
| Total Memory Encryption Multi-Tenant (TME-MT) | Options available: Enabled, Disabled. Default setting is <b>Disabled</b> .   |
| Processor CFR Configuration                   | <p>Press [Enter] to configure advanced items.</p> <ul style="list-style-type: none"> <li>◆ Provision S3M CFR <ul style="list-style-type: none"> <li>– Options available: Disable, Enable. Default setting is <b>Enable</b>.</li> </ul> </li> <li>◆ Manual Commit S3M FW CFR <ul style="list-style-type: none"> <li>– Options available: Disable, Enable, Auto. Default setting is <b>Auto</b>.</li> </ul> </li> <li>◆ Provision PUcode CFR <ul style="list-style-type: none"> <li>– Options available: Disable, Enable. Default setting is <b>Enable</b>.</li> </ul> </li> <li>◆ Manual Commit PUcode CFR <ul style="list-style-type: none"> <li>– Options available: Enable, Disable, Auto. Default setting is <b>Auto</b>.</li> </ul> </li> <li>◆ Socket0 CFR Revision Info <ul style="list-style-type: none"> <li>– Displays CFR Revision information of the socket.</li> </ul> </li> </ul> |

(Note) Advanced items prompt when this item is defined.

### 5-3-2 Common RefCode Configuration

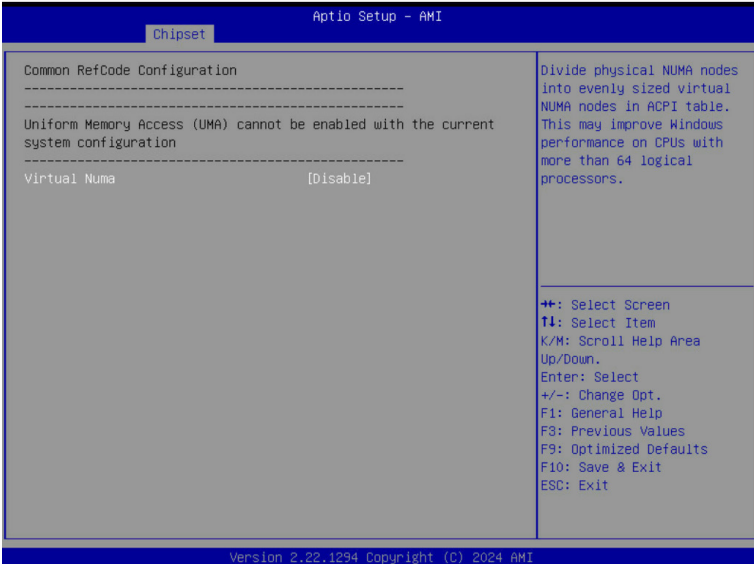

| Parameter                    | Description   |
|------------------------------|---|
| Common RefCode Configuration |   |
| Numa                         | Enable/Disable Non uniform Memory Access(NUMA). Default setting is <b>Enable</b> .  |
| Virtual Numa                 | Divide physical NUMA nodes into evenly sized virtual NUMA nodes in ACPI table. This may improve Windows performance on CPUs with more than 64 logical processors. Options available: Enable, Disable. Default setting is <b>Disable</b> . |

### 5-3-3 UPI Configuration



| Parameter                 | Description  |
|---------------------------|--|
| UPI General Configuration | <p>Press [Enter] to configure advanced items.</p> <ul style="list-style-type: none"> <li>◆ UPI Status <ul style="list-style-type: none"> <li>– Press [Enter] to view the Uncore status.</li> </ul> </li> <li>◆ Link Frequency Select <ul style="list-style-type: none"> <li>– Selects the UPI link frequency.</li> <li>– Options available: 12.8GT/s, 14.4GT/s, 16.0GT/s, Auto, Use Per Link Setting. Default setting is <b>Auto</b>.</li> </ul> </li> <li>◆ SNC <ul style="list-style-type: none"> <li>– Enable/Disable Sub NUMA Cluster function.</li> <li>– Options available: Auto, Disable, Enable SNC2 (2-clusters), Enable SNC4 (4-clusters). Default setting is <b>Auto</b>.</li> </ul> </li> <li>◆ Stale AtoS <ul style="list-style-type: none"> <li>– Enable/Disable Stale A to S directory optimization.</li> <li>– Options available: Disable, Enable, Auto. Default setting is <b>Auto</b>.</li> </ul> </li> <li>◆ LLC dead line alloc <ul style="list-style-type: none"> <li>– Enable/Disable fill dead lines in LLC.</li> <li>– Options available: Disable, Enable, Auto. Default setting is <b>Enable</b>.</li> </ul> </li> <li>◆ MMIO High Base <ul style="list-style-type: none"> <li>– Options available: 56T, 40T, 32T, 24T, 16T, 4T, 2T, 1T, 512G, 3584T. Default setting is <b>32T</b>.</li> </ul> </li> </ul> |

| Parameter                                | Description  |
|--|--|
| UPI General Configuration<br>(continued) | <ul style="list-style-type: none"> <li data-bbox="352 142 956 252">◆ MMIO High Granularity Size <ul style="list-style-type: none"> <li data-bbox="384 169 956 194">– Selects the allocation size used to assign mmioh resources.</li> <li data-bbox="384 200 956 252">– Options available: 1G, 4G, 16G, 64G, 256G, 1024G. Default setting is <b>64G</b>.</li> </ul> </li> <li data-bbox="352 258 956 313">◆ Clock Modulation Enabled <ul style="list-style-type: none"> <li data-bbox="384 285 956 313">– Options available: Disable, Enable, Auto. Default setting is <b>Auto</b>.</li> </ul> </li> </ul> |



### 5-3-4 Memory Configuration



| Parameter                          | Description   |
|------------------------------------|---|
| Integrated Memory Controller (iMC) |   |
| Enforce DDR Memory Frequency POR   | When set to Enable, the system enforces Plan Of Record restrictions for DDR frequency programming.<br>Options available: POR, Disable. Default setting is <b>POR</b> .  |
| Memory Frequency                   | Configures the maximum memory frequency. If Enforce POR is disabled, user will be able to run at higher frequencies than the memory support (limited by processor support).<br>Default setting is <b>Auto</b> . |
| Enable ADR                         | Enables the detecting and enabling of ADR (Asynchronous DRAM Refresh) function.<br>Options available: Enable, Disable. Default setting is <b>Enable</b> .   |
| Legacy ADR Mode                    | Enable/Disable the Legacy ADR Mode.<br>Options available: Enable, Disable, Auto. Default setting is <b>Auto</b> .   |
| Minimum System Memory Size         | Configures the minimum memory size.<br>Options available: 2GB, 4GB, 6GB, 8GB. Default setting is <b>2GB</b> .   |
| ADR Data Save Mode                 | Specifies the Data Save Mode for ADR. Batterybacked or Type 01 NVDIMM.<br>Options available: Disable, Batterybacked DIMMs, NVDIMMs, Copy to Flash. Default setting is <b>NVDIMMs</b> .                          |
| Assert ADR on Reset                | Enable/Disable Assert ADR on Reset.<br>Options available: Enabled, Disabled. Default setting is <b>Disabled</b> .   |

| Parameter                     | Description   |
|-------------------------------|---|
| Assert ADR on S5              | Enable/Disable Assert ADR on S5.<br>Options available: Enabled, Disabled. Default setting is <b>Disabled</b> .  |
| Get Memory Timing             | Auto is the detected SPD value and use it, otherwise use BIOS Build-in.<br>Options available: Auto, BIOS Build-in. Default setting is <b>BIOS Build-in</b> .  |
| Memory Topology               | Press [Enter] to view memory topology with DIMM population information.   |
| Memory Map <sup>(Note1)</sup> | Press [Enter] to configure advanced items. <ul style="list-style-type: none"> <li>◆ Volatile Memory Mode <ul style="list-style-type: none"> <li>– Selects 1LM or 2LM mode for volatile memory.</li> <li>– Options available: 1LM, 2LM. Default setting is <b>2LM</b>.</li> </ul> </li> </ul>  |
| Memory RAS Configuration      | Press [Enter] to configure advanced items. <ul style="list-style-type: none"> <li>◆ Mirror Mode<sup>(Note2)</sup> <ul style="list-style-type: none"> <li>– Mirror Mode will set entire 1LM memory in system to be mirrored, consequently reducing the memory capacity by half. Enables the Mirror Mode will disable the XPT Prefetch.</li> <li>– Options available: Disabled, Full Mirror Mode, Partial Mirror Mode. Default setting is <b>Disabled</b>.</li> </ul> </li> <li>◆ Partial Mirror 1 Size (GB) <ul style="list-style-type: none"> <li>– Selects multiplier of 1GB for the size of the SAD to be created.</li> </ul> </li> <li>◆ Correctable Error Threshold <ul style="list-style-type: none"> <li>– Correctable Error Threshold (0x01-0x7fff) used for sparing, and leaky bucket.</li> <li>– Press the &lt;+&gt; / &lt;-&gt; keys to increase or decrease the desired values.</li> </ul> </li> <li>◆ Trigger SW Error Threshold<sup>(Note2)</sup> <ul style="list-style-type: none"> <li>– Enable/Disable Sparing trigger SW Error Match Threshold.</li> <li>– Options available: Disabled, Enabled. Default setting is <b>Disabled</b>.</li> </ul> </li> <li>◆ SW Per Bank Threshold <ul style="list-style-type: none"> <li>– SW Per Bank Threshold (1-0x7FFF) used for DDR bank level error.</li> <li>– Press the &lt;+&gt; / &lt;-&gt; keys to increase or decrease the desired values.</li> </ul> </li> <li>◆ SW Correctable Error Time Window <ul style="list-style-type: none"> <li>– SW Correctable Error time window based interface in hour (0-24).</li> <li>– Press the &lt;+&gt; / &lt;-&gt; keys to increase or decrease the desired values.</li> </ul> </li> <li>◆ Leaky bucket time window based interface<sup>(Note2)</sup> <ul style="list-style-type: none"> <li>– Enable/Disable leaky bucket time window based interface.</li> <li>– Options available: Disabled, Enabled. Default setting is <b>Disabled</b>.</li> </ul> </li> </ul> |

(Note1) Advanced items prompt when HBM CPU is installed.

(Note2) Advanced items prompt when this item is defined.

| Parameter                               | Description   |
|---|---|
| Memory RAS Configuration<br>(continued) | <ul style="list-style-type: none"> <li>◆ Leaky bucket time window based interface Hour <ul style="list-style-type: none"> <li>– Leaky bucket time window based interface hour used for DDR (0-24).</li> <li>– Press the &lt;+&gt; / &lt;-&gt; keys to increase or decrease the desired values.</li> </ul> </li> <li>◆ Leaky bucket time window based interface Minute <ul style="list-style-type: none"> <li>– Leaky bucket time window based interface minute used for DDR (0-60).</li> <li>– Press the &lt;+&gt; / &lt;-&gt; keys to increase or decrease the desired values.</li> </ul> </li> <li>◆ Leaky bucket low bit <ul style="list-style-type: none"> <li>– Configures leaky bucket low bit (0x1 - 0x29).</li> <li>– Press the &lt;+&gt; / &lt;-&gt; keys to increase or decrease the desired values.</li> </ul> </li> <li>◆ Leaky bucket high bit <ul style="list-style-type: none"> <li>– Configures leaky bucket high bit (0x1 - 0x29).</li> <li>– Press the &lt;+&gt; / &lt;-&gt; keys to increase or decrease the desired values.</li> </ul> </li> <li>◆ ADDDC Sparing<sup>(Note)</sup> <ul style="list-style-type: none"> <li>– Enable/Disable ADDDC Sparing.</li> <li>– Options available: Disabled, Enabled. Default setting is <b>Disabled</b>.</li> </ul> </li> <li>◆ Enable ADDDC Error Injection <ul style="list-style-type: none"> <li>– Options available: Disabled, Enabled. Default setting is <b>Enabled</b>.</li> </ul> </li> <li>◆ Patrol Scrub <ul style="list-style-type: none"> <li>– Options available: Disabled, Enable at End of POST. Default setting is <b>Enable at End of POST</b>.</li> </ul> </li> <li>◆ Patrol Scrub Interval <ul style="list-style-type: none"> <li>– Selects the number of hours (1-24) required to complete full scrub. A value of zero means auto.</li> </ul> </li> <li>◆ DDR5 ECS <ul style="list-style-type: none"> <li>– Options available: Disabled, Enabled, Enable ECS with Result Collection. Default setting is <b>Enabled</b>.</li> </ul> </li> </ul> |

(Note) Advanced items prompt when this item is defined.

### 5-3-5 IIO Configuration

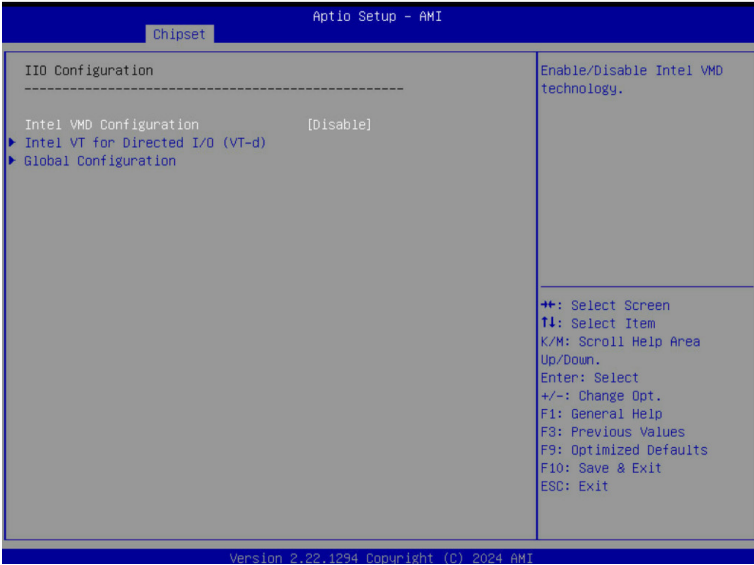

| Parameter         | Description   |
|-------------------|---|
| IIO Configuration | <p>Press [Enter] to configure advanced items.</p> <ul style="list-style-type: none"> <li>◆ Intel® VT for Directed I/O <ul style="list-style-type: none"> <li>– Enable/Disable the Intel VT for Directed I/O (VT-d) support function by reporting the I/O device assignment to VMM through DMAR ACPI Tables.</li> <li>– Options available: Enable, Disable. Default setting is <b>Enable</b>.</li> </ul> </li> <li>◆ ACS Control <ul style="list-style-type: none"> <li>– Enable: Programs ACS only to Chipset PCIe Root Ports Bridges.</li> <li>– Disable: Programs ACS to all PCIe bridges.</li> <li>– Default setting is <b>Enable</b>.</li> </ul> </li> <li>◆ Intel® VT for Directed I/O (VT-d) <ul style="list-style-type: none"> <li>◆ Cache Allocation <ul style="list-style-type: none"> <li>– Options available: Enable, Disable. Default setting is <b>Enable</b>.</li> </ul> </li> <li>◆ Opt-Out Illegal MSI Mitigation <ul style="list-style-type: none"> <li>– Enable/Disable Opt-Out Illegal 0xFEE Platform Mitigation.</li> <li>– Options available: Disable, Enable. Default setting is <b>Disable</b>.</li> </ul> </li> <li>◆ DMA Control Opt-In Flag <ul style="list-style-type: none"> <li>– Enable/Disable DMA_CTRL_PLATFORM_OPT_IN_FLAG in DMAR table in ACPI. Not compatible with Direct Device Assignment (DDA).</li> <li>– Options available: Enable, Disable. Default setting is <b>Disable</b>.</li> </ul> </li> </ul> </li> </ul> |

| Parameter             | Description  |
|-----------------------|--|
|                       | <ul style="list-style-type: none"> <li>◆ Interrupt Remapping <ul style="list-style-type: none"> <li>– Enable/Disable the interrupt remapping support function.</li> <li>– Options available: Auto, Enable, Disable. Default setting is <b>Auto</b></li> </ul> </li> <li>◆ x2APIC Opt Out <ul style="list-style-type: none"> <li>– Options available: Enable, Disable. Default setting is <b>Disable</b>.</li> </ul> </li> <li>◆ Pre-boot DMA Protection <ul style="list-style-type: none"> <li>– Options available: Enable, Disable. Default setting is <b>Disable</b>.</li> </ul> </li> </ul> |
| Intel® VMD technology | <p>Press [Enter] to configure advanced items.</p> <ul style="list-style-type: none"> <li>◆ Intel® VMD Configuration <ul style="list-style-type: none"> <li>– Enable/Disable Intel® VMD technology.</li> <li>– Options available: Enable, Disable. Default setting is <b>Disable</b>.</li> </ul> </li> <li>◆ Intel® VMD for Non-Hotplug NVMe<sup>(Note)</sup> <ul style="list-style-type: none"> <li>– Enable/Disable Intel® VMD for Non-Hotplug NVMe.</li> <li>– Options available: Enable, Disable. Default setting is <b>Disable</b>.</li> </ul> </li> </ul>                                 |

(Note) This item appears when **Intel® VMD Configuration** is set to **Enable**.

### 5-3-6 Advanced Power Management Configuration

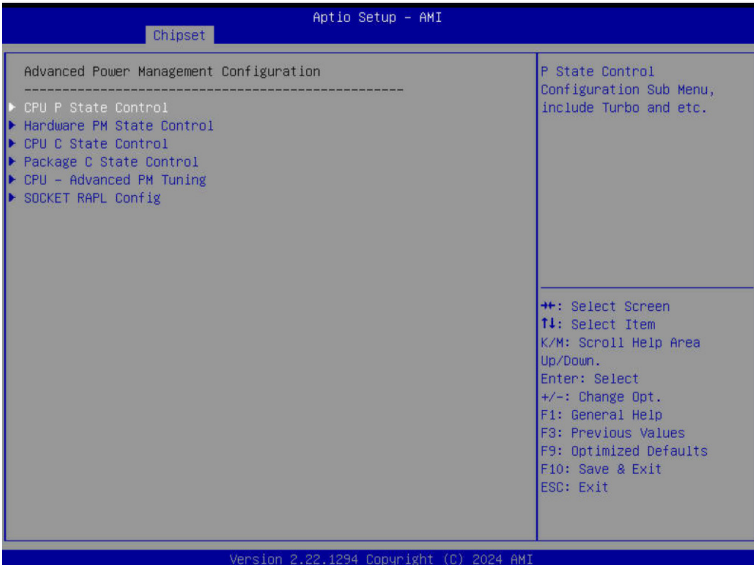

| Parameter                 | Description   |
|---------------------------|---|
| CPU P State Control       | <p>Press [Enter] to configure advanced items.</p> <ul style="list-style-type: none"> <li>◆ SpeedStep (Pstates) <ul style="list-style-type: none"> <li>– Conventional Intel SpeedStep Technology switches both voltage and frequency in tandem between high and low levels in response to processor load.</li> <li>– Options available: Enable, Disable. Default setting is <b>Enable</b>.</li> </ul> </li> <li>◆ Turbo Mode <ul style="list-style-type: none"> <li>– When this item is enabled, the processor will automatically ramp up the clock speed of 1-2 of its processing cores to improve its performance. When this item is disabled, the processor will not overclock any of its core.</li> <li>– Options available: Enable, Disable. Default setting is <b>Enable</b>.</li> </ul> </li> </ul> |
| Hardware PM State Control | <p>Press [Enter] to configure advanced items.</p> <ul style="list-style-type: none"> <li>◆ Hardware P-States <ul style="list-style-type: none"> <li>– When this item is disabled, the processor hardware chooses a P-state based on OS Request (Legacy P-States).</li> <li>– In Native mode, the processor hardware chooses a P-state based on OS guidance.</li> <li>– In Out of Band mode, the processor hardware autonomously chooses a P-state (with no OS guidance).</li> <li>– Options available: Disable, Native Mode, Out of Band Mode, Native Mode with No Legacy Support. Default setting is <b>Native Mode</b>.</li> </ul> </li> </ul>  |

| Parameter                | Description  |
|--------------------------|--|
| CPU C State Control      | <p>Press [Enter] to configure advanced items.</p> <ul style="list-style-type: none"> <li>◆ Enable Monitor MWAIT <ul style="list-style-type: none"> <li>– Allows Monitor and MWAIT instructions.</li> <li>– Options available: Disable, Enable, Auto. Default setting is <b>Auto</b>.</li> </ul> </li> <li>◆ CPU C6 Report <ul style="list-style-type: none"> <li>– Enable/Disable CPU C6(ACPI C3) report to OS.</li> <li>– Options available: Disable, Enable, Auto. Default setting is <b>Auto</b>.</li> </ul> </li> <li>◆ Enhanced Halt State (C1E) <ul style="list-style-type: none"> <li>– Core C1E auto promotion control. Takes effect after reboot.</li> <li>– Options available: Enable, Disable. Default setting is <b>Enable</b>.</li> </ul> </li> </ul> |
| Package C State Control  | <p>Press [Enter] to configure advanced items.</p> <ul style="list-style-type: none"> <li>◆ Package C State <ul style="list-style-type: none"> <li>– Configures the state for the C-State package limit.</li> <li>– Options available: C0/C1 state, C2 state, C6(non Retention) state, C6(Retention) state, No Limit, Auto. Default setting is <b>Auto</b>.</li> </ul> </li> </ul>  |
| CPU - Advanced PM Tuning | <p>Press [Enter] to configure advanced items.</p> <ul style="list-style-type: none"> <li>◆ Energy Perf BIAS <ul style="list-style-type: none"> <li>– Press [Enter] to configure advanced items. <ul style="list-style-type: none"> <li>» Power Performance Tuning <ul style="list-style-type: none"> <li>• Options available: OS Controls EPB, BIOS Controls EPB, PECL Controls EPB. Default setting is <b>OS Controls EPB</b>.</li> </ul> </li> <li>» Energy_PERF_BIAS_CFG mode<sup>(Note)</sup> <ul style="list-style-type: none"> <li>• Options available: Performance, Balanced Performance, Balanced Power, Power. Default setting is <b>Balanced Performance</b>.</li> </ul> </li> </ul> </li> </ul> </li> </ul>   |

(Note) This item is configurable when **Power Performance Tuning** is set to **BIOS Controls EPB**.

### 5-3-7 Miscellaneous Configuration



| Parameter                   | Description   |
|-----------------------------|---|
| Miscellaneous Configuration |   |
| Active Video                | Selects the active video type.<br>Options available: Auto, Onboard Device, PCIE Device, Specific PCIE Device. Default setting is <b>Auto</b> .                          |
| External SSC - CK440        | Enables Spread spectrum - only affects external clock generator.<br>Options available: SSC Off, SSC = -0.3%, SSC = -0.5%, Hardware. Default setting is <b>SSC Off</b> . |



### 5-3-8 Runtime Error Logging Settings

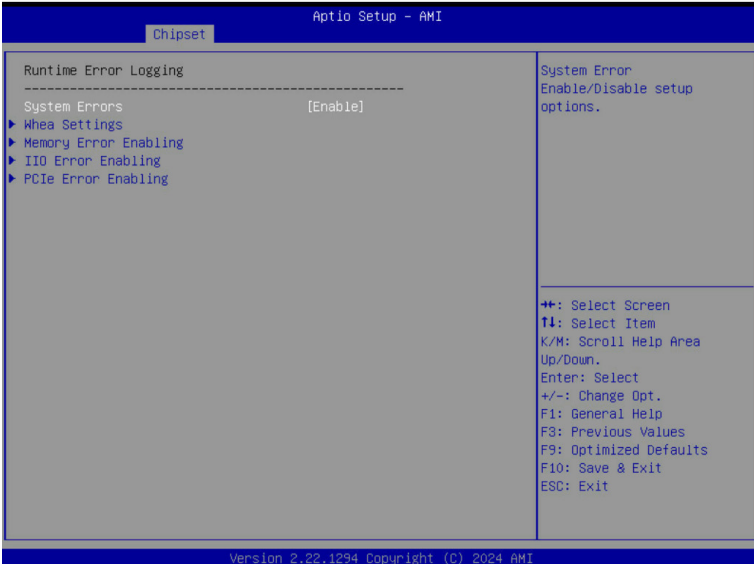

| Parameter                   | Description  |
|-----------------------------|--|
| Runtime Error Logging       |  |
| System Errors               | Enable/Disable system error logging function.<br>Options available: Enable, Disable. Default setting is <b>Enable</b> .  |
| S/W Error Injection Support | Enable/Disable software injection error logging function.<br>Options available: Enable, Disable. Default setting is <b>Disable</b> .   |
| Whea Settings               | Press [Enter] to configure advanced items. <ul style="list-style-type: none"> <li>◆ WHEA (Windows Hardware Error Architecture) Support <ul style="list-style-type: none"> <li>- Enable/Disable WHEA Support.</li> <li>- Options available: Enable, Disable. Default setting is <b>Enable</b>.</li> </ul> </li> </ul>   |
| Memory Error Enabling       | Press [Enter] to configure advanced items. <ul style="list-style-type: none"> <li>◆ Memory Corrected Error <ul style="list-style-type: none"> <li>- Enable/Disable Memory Corrected Error.</li> <li>- Options available: Enable, Disable. Default setting is <b>Enable</b>.</li> </ul> </li> <li>◆ Uncorrected Error disable Memory <ul style="list-style-type: none"> <li>- Enable/Disable the Memory that triggers Uncorrected Error.</li> <li>- Options available: Enable, Disable. Default setting is <b>Disable</b>.</li> </ul> </li> </ul> |

| Parameter           | Description   |
|---------------------|---|
| PCIe Error Enabling | <p data-bbox="309 142 642 166">Press [Enter] to configure advanced items.</p> <ul style="list-style-type: none"> <li data-bbox="309 170 852 252">◆ PCIe Error <ul style="list-style-type: none"> <li data-bbox="344 200 580 224">– Enable/Disable PCIe error.</li> <li data-bbox="344 228 852 252">– Options available: Enable, Disable. Default setting is <b>Disable</b>.</li> </ul> </li> <li data-bbox="309 257 923 338">◆ Uncorrected Error<sup>(Note)</sup> <ul style="list-style-type: none"> <li data-bbox="344 286 923 310">– Enables and escalates Uncorrectable/Recoverable Errors to error pins.</li> <li data-bbox="344 315 846 338">– Options available: Enable, Disable. Default setting is <b>Enable</b>.</li> </ul> </li> <li data-bbox="309 343 846 424">◆ Fatal Error Enable<sup>(Note)</sup> <ul style="list-style-type: none"> <li data-bbox="344 373 749 396">– Enables and escalates Fatal Errors to error pins.</li> <li data-bbox="344 401 846 424">– Options available: Enable, Disable. Default setting is <b>Enable</b>.</li> </ul> </li> <li data-bbox="309 429 940 545">◆ Assert NMI on SERR<sup>(Note)</sup> <ul style="list-style-type: none"> <li data-bbox="344 459 940 514">– Enable/Disable BIOS generates a non-maskable interrupt (NMI) and logs an error when a system error (SERR) occurs.</li> <li data-bbox="344 519 876 542">– Options available: Enabled, Disabled. Default setting is <b>Enabled</b>.</li> </ul> </li> <li data-bbox="309 550 940 663">◆ Assert NMI on PERR<sup>(Note)</sup> <ul style="list-style-type: none"> <li data-bbox="344 580 940 635">– Enable/Disable BIOS generates a non-maskable interrupt (NMI) and logs an error when a processor bus parity error (PERR) occurs.</li> <li data-bbox="344 639 876 663">– Options available: Enabled, Disabled. Default setting is <b>Enabled</b>.</li> </ul> </li> </ul> |

(Note) This item appears when **PCIe Error** is set to **Enable**.

### 5-3-9 Power Policy



| Parameter                   | Description   |
|-----------------------------|---|
| Power Policy Quick Settings | Selects a Power Policy Quick Setting.<br>Options available: Standard, Best Performance, Energy Efficient. Default setting is <b>Standard</b> .  |
| SpeedStep (Pstates)         | Conventional Intel SpeedStep Technology switches both voltage and frequency in tandem between high and low levels in response to processor load.<br>Options available: Enable, Disable. Default setting is <b>Enable</b> .  |
| Turbo Mode                  | When this item is enabled, the processor will automatically ramp up the clock speed of 1-2 of its processing cores to improve its performance.<br>When this item is disabled, the processor will not overclock any of its core.<br>Options available: Enable, Disable. Default setting is <b>Enable</b> . |
| CPU C6 report               | Enable/Disable the BIOS to enable the report from the CPU C6 state (ACPI C3) to the OS.<br>Options available: Disable, Enable, Auto. Default setting is <b>Auto</b> .   |
| Enhanced Halt State (C1E)   | Enable/Disable the C1E support for lower power consumption. Takes effect after reboot.<br>Options available: Enable, Disable. Default setting is <b>Enable</b> .  |
| Package C State             | Configures the C-State package limit.<br>Options available: C0/C1 state, C2 state, C6(non Retention) state, C6(Retention) state, No Limit, Auto. Default setting is <b>Auto</b> .   |

| Parameter                  | Description  |
|----------------------------|--|
| Enable LP [Global]         | Enables Logical processor (Software Method to Enable/Disable Logical Processor threads).<br>Options available: ALL LPs, Single LP. Default setting is <b>ALL LPs</b> .   |
| Hardware Prefetcher        | Options available: Enable, Disable. Default setting is <b>Enable</b> .   |
| Adjacent Cache Prefetch    | Options available: Enable, Disable. Default setting is <b>Enable</b> .   |
| DCU Streamer Prefetcher    | Options available: Enable, Disable. Default setting is <b>Enable</b> .   |
| Intel® VT for Directed I/O | Enable/Disable the Intel VT for Directed I/O (VT-d) support function by reporting the I/O device assignment to VMM through DMAR ACPI Tables.<br>Options available: Enable, Disable. Default setting is <b>Enable</b> . |

## 5-4 Server Management Menu



| Parameter                               | Description  |
|---|--|
| FRB-2 Timer                             | Enable/Disable FRB-2 timer (POST timer).<br>Options available: Enabled, Disabled. Default setting is <b>Enabled</b> .                            |
| FRB-2 Timer <sup>(Note1)</sup> timeout  | Configures the FRB2 Timer timeout. The value is between 1 to 30 minutes.<br>Default setting is <b>6 minutes</b> .                                |
| FRB-2 Timer Policy <sup>(Note1)</sup>   | Configures the FRB2 Timer policy.<br>Options available: Do Nothing, Reset, Power Down, Power Cycle.<br>Default setting is <b>Do Nothing</b> .    |
| OS Watchdog Timer                       | Enable/Disable OS Watchdog Timer function.<br>Options available: Enabled, Disabled. Default setting is <b>Disabled</b> .                         |
| OS Wtd Timer Timeout <sup>(Note2)</sup> | Configures OS Watchdog Timer. The value is between 1 to 30 minutes.<br>Default setting is <b>10 minutes</b> .                                    |
| OS Wtd Timer Policy <sup>(Note2)</sup>  | Configure OS Watchdog Timer Policy.<br>Options available: Reset, Do Nothing, Power Down, Power Cycle.<br>Default setting is <b>Reset</b> .       |
| Wait BMC Ready                          | POST wait BMC ready and reboot system.<br>Options available: Disabled, 2 minutes, 4 minutes, 6 minutes.<br>Default setting is <b>2 minutes</b> . |

(Note1) This item is configurable when **FRB-2 Timer** is set to **Enabled**.

(Note2) This item is configurable when **OS Watchdog Timer** is set to **Enabled**.

| <b>Parameter</b>               | <b>Description</b>                         |
|--------------------------------|--|
| System Event Log               | Press [Enter] to configure advanced items. |
| View FRU Information           | Press [Enter] to view the FRU information. |
| BMC VLAN Configuration         | Press [Enter] to configure advanced items. |
| BMC network Configuration      | Press [Enter] to configure advanced items. |
| IPv6 BMC Network Configuration | Press [Enter] to configure advanced items. |

# 5-4-1 System Event Log

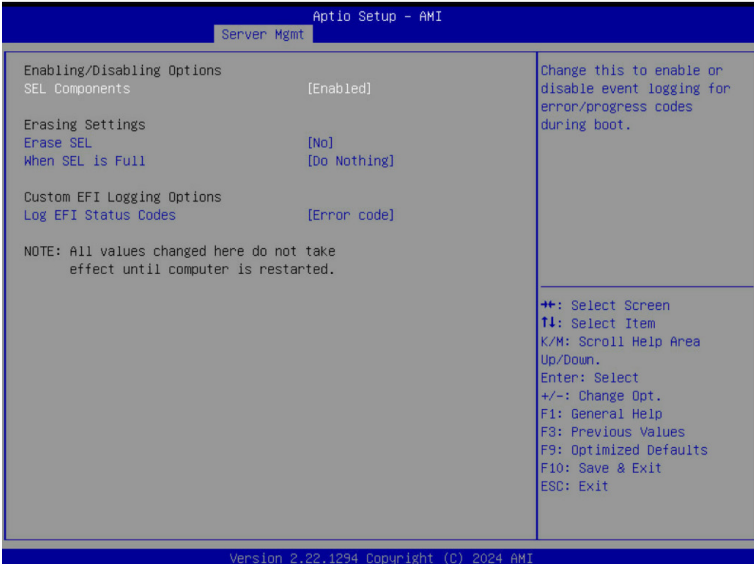

| Parameter                    | Description  |
|------------------------------|--|
| Enabling / Disabling Options |  |
| SEL Components               | Change this item to enable or disable all features of System Event Logging during boot.<br>Options available: Enabled, Disabled. Default setting is <b>Enabled</b> .                         |
| Erasing Settings             |  |
| Erase SEL                    | Choose options for erasing SEL.<br>Options available: No, Yes, On next reset, Yes, On every reset.<br>Default setting is <b>No</b> .   |
| When SEL is Full             | Choose options for reactions to a full SEL.<br>Options available: Do Nothing, Erase Immediately, Delete Oldest Record.<br>Default setting is <b>Do Nothing</b> .                             |
| Custom EFI Logging Options   |  |
| Log EFI Status Codes         | Enable/Disable the logging of EFI Status Codes (if not already converted to legacy).<br>Options available: Disabled, Both, Error code, Progress code. Default setting is <b>Error code</b> . |

## 5-4-2 View FRU Information

The FRU page is a simple display page for basic system ID information, as well as System product information. Items on this window are non-configurable.

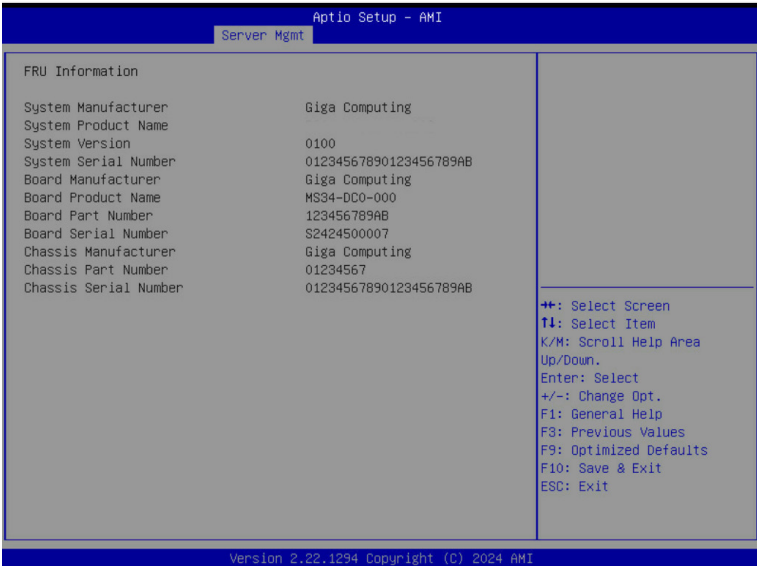

(Note) The model name will vary depends on the product you purchased



### 5-4-3 BMC VLAN Configuration

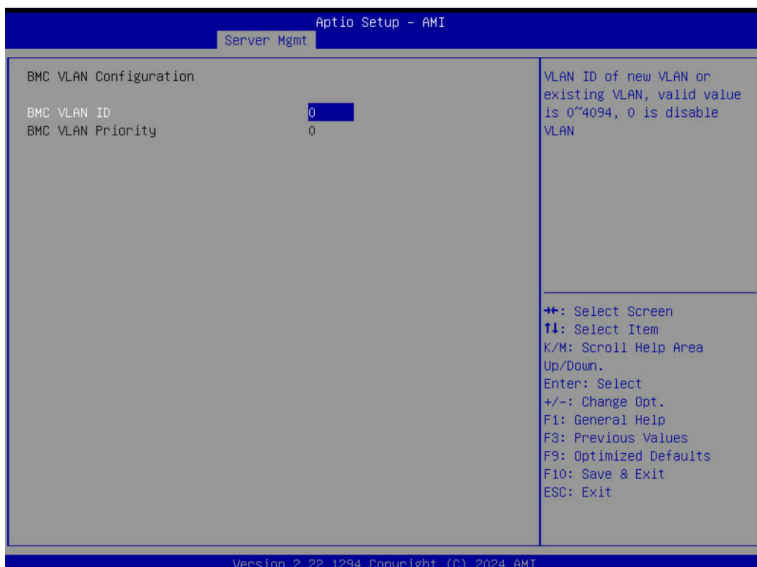

| Parameter              | Description  |
|------------------------|--|
| BMC VLAN Configuration |  |
| BMC VLAN ID            | Select to configure BMC VLAN ID. The valid range is from 0 to 4094. When set to 0, BMC VLAN ID will be disabled.                             |
| BMC VLAN Priority      | Select to configure BMC VLAN Priority. The valid range is from 0 to 7. When BMC VLAN ID is set to 0, BMC VLAN Priority will not be selected. |

## 5-4-4 BMC Network Configuration

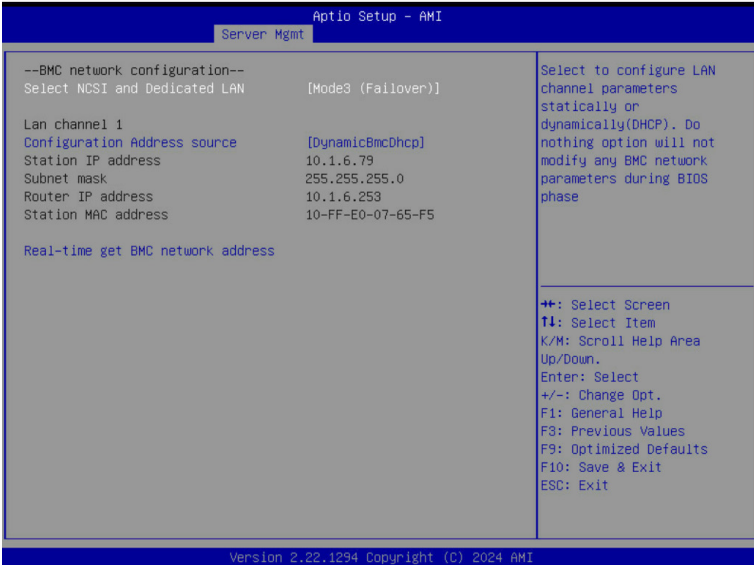

| Parameter                         | Description   |
|-----------------------------------|---|
| BMC network configuration         |   |
| Select NCSI and Dedicated LAN     | Options available: Do Nothing, Model1(Dedicated), Model2(NCSI), Mode3(Failover). Default setting is <b>Do Nothing</b> .   |
| Lan Channel 1                     |   |
| Configuration Address source      | Selects to configure LAN channel parameters statically or dynamically (DHCP).<br>Options available: Unspecified, Static, DynamicBmcDhcp. Default setting is <b>DynamicBmcDhcp</b> . |
| Station IP address                | Displays IP Address information.  |
| Subnet mask                       | Displays Subnet Mask information.<br>Please note that the IP address must be in three digitals, for example, 192.168.000.001.   |
| Router IP address                 | Displays the Router IP Address information.   |
| Station MAC address               | Displays the MAC Address information.   |
| Real-time get BMC network address | Press [Enter] will set LAN mode and Address source and then get IP, Subnet, Gateway and MAC address.  |

## 5-4-5 IPv6 BMC Network Configuration

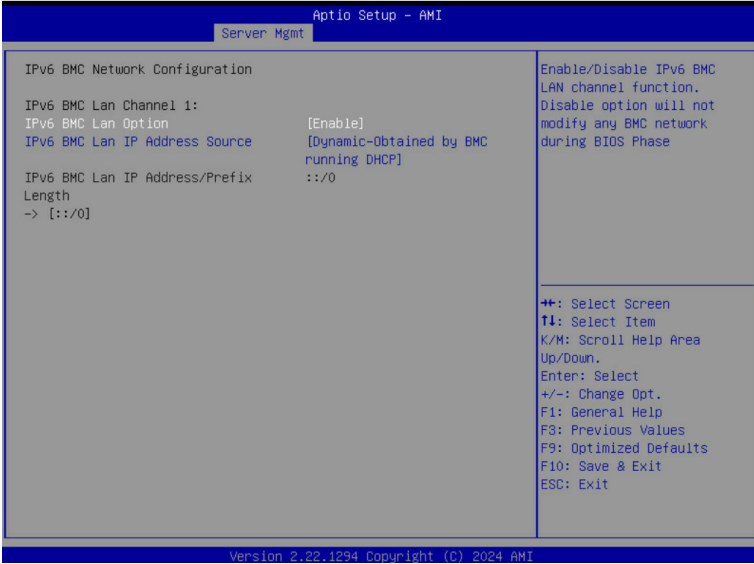

| Parameter                             | Description   |
|---------------------------------------|---|
| IPv6 BMC network configuration        |   |
| IPv6 BMC Lan Channel 1                |   |
| IPv6 BMC Lan Option                   | Enable/Disable IPv6 BMC LAN channel function. When this item is disabled, the system will not modify any BMC network during BIOS phase.<br>Options available: Unspecified, Disable, Enable. Default setting is <b>Enable</b> .            |
| IPv6 BMC Lan IP Address Source        | Selects to configure LAN channel parameters statically or dynamically (by BIOS or BMC).<br>Options available: Unspecified, Static, Dynamic-Obtained by BMC running DHCP. Default setting is <b>Dynamic-Obtained by BMC running DHCP</b> . |
| IPv6 BMC Lan IP Address/Prefix Length | Check if the IPv6 BMC LAN IP address matches those displayed on the screen.   |

# 5-5 Security Menu

The Security menu allows you to safeguard and protect the system from unauthorized use by setting up access passwords.

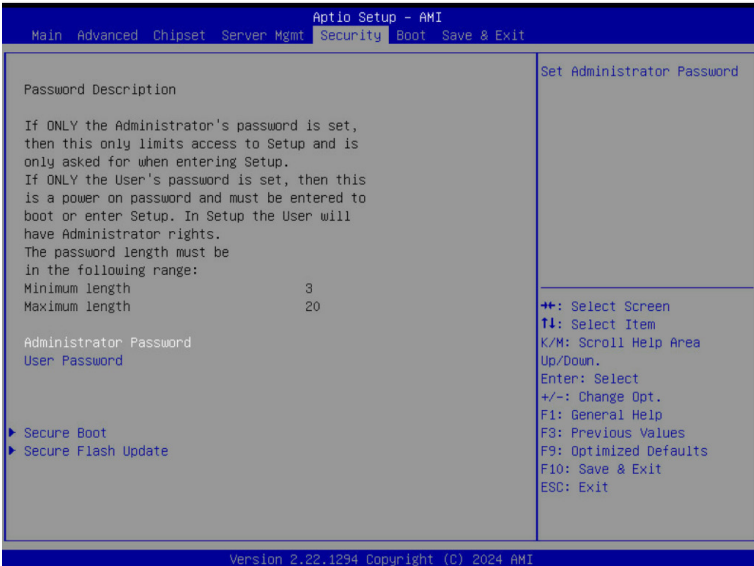

There are two types of passwords that you can set:

- Administrator Password  
Entering this password will allow the user to access and change all settings in the Setup Utility.
- User Password  
Entering this password will restrict a user's access to the Setup menus. To enable or disable this field, a Administrator Password must first be set. A user can only access and modify the System Time, System Date, and Set User Password fields.

| Parameter              | Description  |
|------------------------|--|
| Administrator Password | Press [Enter] to configure the administrator password. |
| User Password          | Press [Enter] to configure the user password.          |
| Secure Boot            | Press [Enter] to configure advanced items.             |

## 5-5-1 Secure Boot

The Secure Boot feature is applicable if supported by your Operating System. If your Operating System is not supporting Secure Boot, the system will hang when starting the Operating System.



| Parameter                          | Description  |
|------------------------------------|--|
| System Mode                        | Displays if the system is in User mode or Setup mode.  |
| Secure Boot                        | Enable/ Disable the Secure Boot function.<br>Options available: Enabled, Disabled. Default setting is <b>Disabled</b> .  |
| Secure Boot Mode <sup>(Note)</sup> | Secure Boot requires all the applications that are running during the booting process to be pre-signed with valid digital certificates. This way, the system knows all files being loaded before the Operating System loads to the login screen have not been tampered with.<br>When set to Standard, it will automatically load the Secure Boot keys form the BIOS databases.<br>When set to Custom, you can customize the Secure Boot settings and manually load its keys from the BIOS database.<br>Options available: Standard, Custom. Default setting is <b>Custom</b> . |
| Restore Factory Keys               | Forces the system to user mode and installs factory default Secure Boot key database.  |
| Reset To Setup Mode                | Reset the system to Setup Mode.  |

(Note) Advanced items prompt when this item is set to **Custom**.

| Parameter      | Description   |
|----------------|---|
| Key Management | <p data-bbox="333 158 666 181">Press [Enter] to configure advanced items.</p> <p data-bbox="333 186 937 236"><b>Please note that this item is configurable when Secure Boot Mode is set to Custom.</b></p> <ul style="list-style-type: none"> <li data-bbox="333 241 944 349">◆ Factory Key Provision <ul style="list-style-type: none"> <li data-bbox="370 268 944 318">– Allows to provision factory default Secure Boot keys when system is in Setup Mode.</li> <li data-bbox="370 323 905 349">– Options available: Enabled, Disabled. Default setting is <b>Disabled</b>.</li> </ul> </li> <li data-bbox="333 354 926 432">◆ Restore Factory Keys <ul style="list-style-type: none"> <li data-bbox="370 381 926 406">– Installs all factory default keys. It will force the system in User Mode.</li> <li data-bbox="370 410 607 432">– Options available: Yes, No.</li> </ul> </li> <li data-bbox="333 437 655 515">◆ Reset To Setup Mode <ul style="list-style-type: none"> <li data-bbox="370 464 655 489">– Reset the system to Setup Mode.</li> <li data-bbox="370 493 607 515">– Options available: Yes, No.</li> </ul> </li> <li data-bbox="333 520 902 598">◆ Enroll Efi Image <ul style="list-style-type: none"> <li data-bbox="370 547 902 598">– Press [Enter] to enroll SHA256 hash of the binary into Authorized Signature Database (db).</li> </ul> </li> <li data-bbox="333 603 937 682">◆ Export Secure Boot variables <ul style="list-style-type: none"> <li data-bbox="370 630 937 682">– Copy NVRAM content of Secure Boot variables to files in a root folder on a file system device.</li> </ul> </li> <li data-bbox="333 686 898 736">◆ Secure Boot variable <ul style="list-style-type: none"> <li data-bbox="370 713 898 736">– Displays the current status of the variables used for secure boot.</li> </ul> </li> <li data-bbox="333 741 802 849">◆ Platform Key (PK) <ul style="list-style-type: none"> <li data-bbox="370 768 802 793">– Displays the current status of the Platform Key (PK).</li> <li data-bbox="370 798 678 823">– Press [Enter] to configure a new PK.</li> <li data-bbox="370 827 602 849">– Options available: Update.</li> </ul> </li> <li data-bbox="333 854 944 994">◆ Key Exchange Keys (KEK) <ul style="list-style-type: none"> <li data-bbox="370 881 944 906">– Displays the current status of the Key Exchange Key Database (KEK).</li> <li data-bbox="370 911 905 961">– Press [Enter] to configure a new KEK or load additional KEK from storage devices.</li> <li data-bbox="370 965 671 994">– Options available: Update, Append.</li> </ul> </li> <li data-bbox="333 998 944 1138">◆ Authorized Signatures (DB) <ul style="list-style-type: none"> <li data-bbox="370 1025 905 1050">– Displays the current status of the Authorized Signature Database.</li> <li data-bbox="370 1055 944 1105">– Press [Enter] to configure a new DB or load additional DB from storage devices.</li> <li data-bbox="370 1110 671 1138">– Options available: Update, Append.</li> </ul> </li> <li data-bbox="333 1143 902 1273">◆ Forbidden Signatures (DBX) <ul style="list-style-type: none"> <li data-bbox="370 1169 902 1194">– Displays the current status of the Forbidden Signature Database.</li> <li data-bbox="370 1199 891 1249">– Press [Enter] to configure a new dbx or load additional dbx from storage devices.</li> <li data-bbox="370 1254 671 1273">– Options available: Update, Append.</li> </ul> </li> </ul> |

| Parameter                     | Description   |
|-------------------------------|---|
| Key Management<br>(continued) | <ul style="list-style-type: none"> <li>◆ Authorized TimeStamps (DBT) <ul style="list-style-type: none"> <li>– Displays the current status of the Authorized TimeStamps Database.</li> <li>– Press [Enter] to configure a new DBT or load additional DBT from storage devices.</li> <li>– Options available: Update, Append.</li> </ul> </li> <li>◆ OsRecovery Signatures <ul style="list-style-type: none"> <li>– Displays the current status of the OsRecovery Signature Database.</li> <li>– Press [Enter] to configure a new OsRecovery Signature or load additional OsRecovery Signature from storage devices.</li> <li>– Options available: Update, Append.</li> </ul> </li> </ul> |

## 5-6 Boot Menu

The Boot menu allows you to set the drive priority during system boot-up. BIOS setup will display an error message if the legacy drive(s) specified is not bootable.

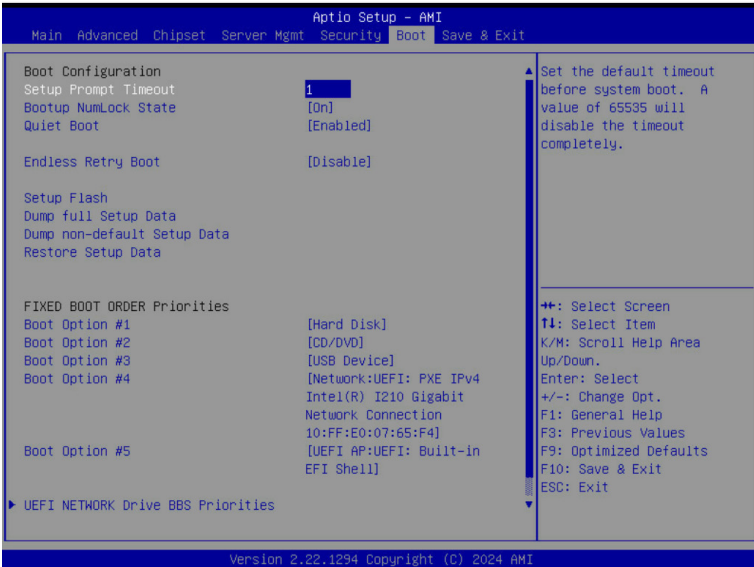

| Parameter                   | Description   |
|-----------------------------|---|
| Boot Configuration          |   |
| Setup Prompt Timeout        | Number of seconds to wait for setup activation key. 65535 (0xFFFF) means indefinite waiting.<br>Press the numeric keys to input the desired values. |
| Bootup NumLock State        | Enable/Disable the Bootup NumLock function.<br>Options available: On, Off. Default setting is <b>On</b> .   |
| Quiet Boot                  | Enable/Disable showing the logo during POST.<br>Options available: Enabled, Disabled. Default setting is <b>Enabled</b> .                           |
| Endless Retry Boot          | Options available: Disable, Enable. Default setting is <b>Disable</b> .   |
| Setup Flash                 | Press [Enter] to run setup flash.   |
| Dump full Setup Data        | Press [Enter] to dump full setup data to file.  |
| Dump non-default Setup Data | Press [Enter] to dump non-default setup data to file.   |
| Restore Setup Data          | Press [Enter] to restore setup data from file.  |



| Parameter                          | Description  |
|------------------------------------|--|
| FIXED BOOT ORDER Priorities        |  |
| Boot Option #1 / #2 / #3 / #4 / #5 | <p>Press [Enter] to configure the boot order priority.<br/>By default, the server searches for boot devices in the following sequence:</p> <ol style="list-style-type: none"> <li>1. Hard drive.</li> <li>2. CD-COM/DVD drive.</li> <li>3. USB device.</li> <li>4. Network.</li> <li>5. UEFI.</li> </ol> |
| UEFI Network Drive BBS Priorities  | Press [Enter] to configure the boot priority.  |
| UEFI Application Boot Priorities   | Press [Enter] to configure the boot priority.  |

## 5-7 Save & Exit Menu

The Save & Exit menu displays the various options to quit from the BIOS setup. Highlight any of the exit options then press <Enter>.

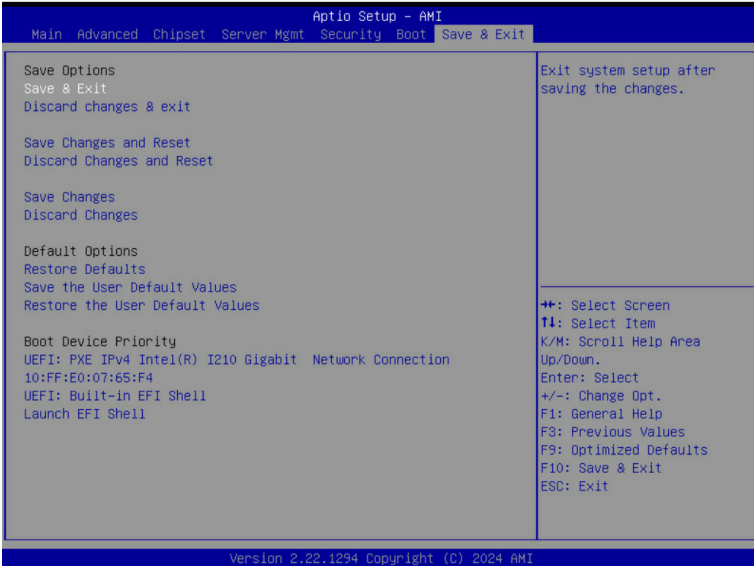

| Parameter                 | Description   |
|---------------------------|---|
| Save Options              |   |
| Save and Exit             | Saves changes made and closes the BIOS setup.<br>Options available: Yes, No.          |
| Discard changes and exit  | Discards changes made and exits the BIOS setup.<br>Options available: Yes, No.        |
| Save Changes and Reset    | Restarts the system after saving the changes made.<br>Options available: Yes, No.     |
| Discard Changes and Reset | Restarts the system without saving any changes.<br>Options available: Yes, No.        |
| Save Changes              | Saves changes done so far to any of the setup options.<br>Options available: Yes, No. |
| Discard Changes           | Discards changes made and closes the BIOS setup.<br>Options available: Yes, No.       |
| Default Options           |   |

| <b>Parameter</b>                | <b>Description</b>   |
|---------------------------------|--|
| Restore Defaults                | Loads the default settings for all BIOS setup parameters. Setup Defaults are quite demanding in terms of resources consumption. If you are using low-speed memory chips or other kinds of low-performance components and you choose to load these settings, the system might not function properly.<br>Options available: Yes, No. |
| Save the User Default Values    | Saves the changes made as the user default settings.<br>Options available: Yes, No.  |
| Restore the User Default Values | Loads the user default settings for all BIOS setup parameters.<br>Options available: Yes, No.  |
| Boot Device Priority            | Press [Enter] to configure the device as the boot-up drive.  |
| Launch EFI Shell                | Attempts to Launch EFI Shell application (Shell.efi) from one of the available file system devices.  |

## 5-8 BIOS Recovery

The system has an embedded recovery technique. In the event that the BIOS becomes corrupt the boot block can be used to restore the BIOS to a working state. To restore your BIOS, please follow the instructions listed below:

Recovery Instruction:

1. Copy the XXX.rom to USB diskette.
2. Setting BIOS Recovery jump to enabled status.
3. Boot into BIOS recovery.
4. Run Proceed with flash update.
5. BIOS updated.

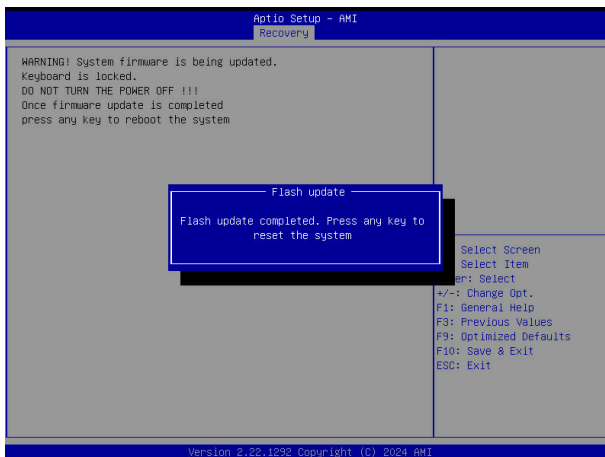

## 5-9 BIOS POST Beep code (AMI standard)

### 5-9-1 PEI Beep Codes

| # of Beeps | Description  |
|------------|--|
| 1          | Memory not Installed.  |
| 1          | Memory was installed twice (InstallPeiMemory routine in PEI Core called twice) |
| 2          | Recovery started   |
| 3          | DXE IPL was not found  |
| 3          | DXE Core Firmware Volume was not found   |
| 4          | Recovery failed  |
| 4          | S3 Resume failed   |
| 7          | Reset PPI is not available   |

### 5-9-2 DXE Beep Codes

| # of Beeps | Description   |
|------------|---|
| 1          | Invalid password                                      |
| 4          | Some of the Architectural Protocols are not available |
| 5          | No Console Output Devices are found                   |
| 5          | No Console Input Devices are found                    |
| 6          | Flash update is failed                                |
| 7          | Reset protocol is not available                       |
| 8          | Platform PCI resource requirements cannot be met      |