

GIGABYTE™

R263-Z37-AAC1

R263-Z37-AAH1

Rack Server - AMD EPYC™ 9005/9004 - 2U UP 12+2-Bay Gen5 NVMe/SATA/SAS-4

User Manual

Rev. 3.0

Copyright

© 2024 Giga Computing Technology CO., LTD. All rights reserved.

The trademarks mentioned in this manual are legally registered to their respective owners.

Disclaimer

Information in this manual is protected by copyright laws and is the property of Giga Computing. Changes to the specifications and features in this manual may be made by Giga Computing without prior notice. No part of this manual may be reproduced, copied, translated, transmitted, or published in any form or by any means without Giga Computing's prior written permission.

Documentation Classifications

In order to assist in the use of this product, Giga Computing provides the following types of documentation:

- User Manual: detailed information & steps about the installation, configuration and use of this product (e.g. motherboard, server barebones), covering hardware and BIOS.
- User Guide: detailed information about the installation & use of an add-on hardware or software component (e.g. BMC firmware, rail-kit) compatible with this product.
- Quick Installation Guide: a short guide with visual diagrams that you can reference easily for installation purposes of this product (e.g. motherboard, server barebones).

Please see the support section of the online product page to check the current availability of these documents.

For More Information

For related product specifications, the latest firmware and software, and other information please visit our website at <http://www.gigabyte.com/Enterprise>



For GIGABYTE distributors and resellers, additional sales & marketing materials are available from our reseller portal: <http://reseller.b2b.gigabyte.com>

For further technical assistance, please contact your GIGABYTE representative or visit <https://support.gigabyte.com/> to create a new support ticket

For any general sales or marketing enquiries, you may also message GIGABYTE server directly by email: server.grp@gigabyte.com

Conventions

The following conventions are used in this user's guide:

| | |
|---|--|
|  | <p>NOTE!</p> <p>Gives bits and pieces of additional information related to the current topic.</p> |
|  | <p>CAUTION!</p> <p>Gives precautionary measures to avoid possible hardware or software problems.</p> |
|  | <p>WARNING!</p> <p>Alerts you to any damage that might result from doing or not doing specific actions.</p> |

Server Warnings and Cautions

Before installing a server, be sure that you understand the following warnings and cautions.



WARNING!

To reduce the risk of electric shock or damage to the equipment:

- Do not disable the power cord grounding plug. The grounding plug is an important safety feature.
- Plug the power cord into a grounded (earthed) electrical outlet that is easily accessible at all times.
- Unplug all the power cords from the power supplies to disconnect power to the equipment.



- Shock Hazard! Disconnect all power supply cords before servicing.
- Do not route the power cord where it can be walked on or pinched by items placed against it. Pay particular attention to the plug, electrical outlet, and the point where the cord extends from the server.



WARNING!

To reduce the risk of personal injury from hot surfaces, allow the drives and the internal system components to cool before touching them.



WARNING!

This server is equipped with high speed fans. Keep away from hazardous moving fan blades during servicing.



WARNING!

This equipment is intended to be used in Restrict Access Location. The access can only be gained by Skilled person. Only authorized by well trained professional person can access the restrict access location.



WARNING!

The equipment should only be repaired, maintained or replaced by skilled personnel.



CAUTION!

- Do not operate the server for long periods with the access panel open or removed. Operating the server in this manner results in improper airflow and improper cooling that can lead to thermal damage.
- Danger of explosion if battery is incorrectly replaced.
- Replace only with the same or equivalent type recommended by the manufacturer.
- Dispose of used batteries according to the manufacturer's instructions.



CAUTION!

Risk of explosion if battery is replaced incorrectly or with an incorrect type. Replace the battery only with the same or equivalent type recommended by the manufacturer. Dispose of used batteries according to the manufacturer's instructions.

Electrostatic Discharge (ESD)



CAUTION!

ESD CAN DAMAGE DRIVES, BOARDS, AND OTHER PARTS. WE RECOMMEND THAT YOU PERFORM ALL PROCEDURES AT AN ESD WORKSTATION. IF ONE IS NOT AVAILABLE, PROVIDE SOME ESD PROTECTION BY WEARING AN ANTI-STATIC WRIST STRAP ATTACHED TO CHASSIS GROUND -- ANY UNPAINTED METAL SURFACE -- ON YOUR SERVER WHEN HANDLING PARTS.

Always handle boards carefully. They can be extremely sensitive to ESD. Hold boards only by their edges without any component and pin touching. After removing a board from its protective wrapper or from the system, place the board component side up on a grounded, static free surface. Use a conductive foam pad if available but not the board wrapper. Do not slide board over any surface.

System power on/off: To remove power from system, you must remove the system from rack. Make sure the system is removed from the rack before opening the chassis, adding, or removing any non hot-plug components.

Hazardous conditions, devices and cables: Hazardous electrical conditions may be present on power, telephone, and communication cables. Turn off the system and disconnect the cables attached to the system before servicing it. Otherwise, personal injury or equipment damage can result.

Electrostatic discharge (ESD) and ESD protection: ESD can damage drives, boards, and other parts. We recommend that you perform all procedures in this chapter only at an ESD workstation. If one is not available, provide some ESD protection by wearing an antistatic wrist strap attached to chassis ground (any unpainted metal surface on the server) when handling parts.

ESD and handling boards: Always handle boards carefully. They can be extremely sensitive to electrostatic discharge (ESD). Hold boards only by their edges. After removing a board from its protective wrapper or from the system, place the board component side up on a grounded, static free surface. Use a conductive foam pad if available but not the board wrapper. Do not slide board over any surface.

Installing or removing jumpers: A jumper is a small plastic encased conductor that slips over two jumper pins. Some jumpers have a small tab on top that can be gripped with fingertips or with a pair of fine needle nosed pliers. If the jumpers do not have such a tab, take care when using needle nosed pliers to remove or install a jumper; grip the narrow sides of the jumper with the pliers, never the wide sides. Gripping the wide sides can damage the contacts inside the jumper, causing intermittent problems with the function controlled by that jumper. Take care to grip with, but not squeeze, the pliers or other tool used to remove a jumper, or the pins on the board may bend or break.

Table of Contents

| | |
|--|----|
| Chapter 1 Hardware Installation | 9 |
| 1-1 Installation Precautions | 9 |
| 1-2 Product Specifications | 10 |
| 1-3 System Block Diagram | 14 |
| Chapter 2 System Appearance | 15 |
| 2-1 Front View | 15 |
| 2-2 Rear View | 16 |
| 2-3 Front Panel LEDs and Buttons | 17 |
| 2-3-1 RoT LEDs | 18 |
| 2-4 Rear System LAN LEDs | 20 |
| 2-5 Power Supply Unit (PSU) LED | 21 |
| 2-6 Hard Disk Drive LEDs | 22 |
| Chapter 3 System Hardware Installation | 23 |
| 3-1 Removing Chassis Cover | 24 |
| 3-2 Removing and Installing the Fan Duct | 25 |
| 3-3 Removing and installing the Heat Sink | 26 |
| 3-4 Installing the CPU | 27 |
| 3-5 Installing the Memory | 29 |
| 3-5-1 Twelve Channel Memory Configuration | 29 |
| 3-5-2 Installing the Memory | 30 |
| 3-5-3 Processor and Memory Module Matrix Table | 31 |
| 3-5-4 DIMM Population Table | 31 |
| 3-6 Installing the PCI Expansion Card | 32 |
| 3-7 Installing the Mezzanine Card | 33 |
| 3-7-1 OCP 3.0 | 33 |
| 3-8 Installing the Hard Disk Drive | 34 |
| 3-9 Installing the M.2 Device and Heat Sink | 37 |
| 3-10 Replacing the Fan Assembly | 38 |
| 3-11 Replacing the Power Supply | 39 |
| 3-12 Cable Routing | 40 |
| Chapter 4 Motherboard Components | 43 |
| 4-1 Motherboard Components | 43 |
| 4-2 Jumper Setting | 45 |

| | | |
|-----------|--|-----|
| 4-3 | Backplane Board Storage Connector | 46 |
| 4-3-1 | CBP20C7..... | 46 |
| 4-3-2 | CBP2025 (Rear System Storage Board)..... | 47 |
| Chapter 5 | BIOS Setup | 48 |
| 5-1 | The Main Menu | 50 |
| 5-2 | Advanced Menu | 53 |
| 5-2-1 | CPU Configuration..... | 54 |
| 5-2-2 | NVMe Configuration | 55 |
| 5-2-3 | SATA Configuration..... | 56 |
| 5-2-4 | USB Configuration..... | 57 |
| 5-2-5 | PCI Subsystem Settings..... | 59 |
| 5-2-6 | AST2600 Super IO Configuration..... | 61 |
| 5-2-7 | Serial Port Console Redirection | 63 |
| 5-2-8 | Network Stack Configuration | 67 |
| 5-2-9 | Post Report Configuration | 68 |
| 5-2-10 | Trusted Computing..... | 69 |
| 5-2-11 | PSP Firmware Versions..... | 70 |
| 5-2-12 | S5 RTC Wake Settings..... | 71 |
| 5-2-13 | Graphic Output Configuration..... | 72 |
| 5-2-14 | AMD Mem Configuration Status..... | 73 |
| 5-2-15 | Tls Auth Configuration | 74 |
| 5-2-16 | RAM Disk Configuration | 75 |
| 5-2-17 | iSCSI Configuration..... | 76 |
| 5-2-18 | Intel(R) I210 Gigabit Network Connection | 77 |
| 5-2-19 | VLAN Configuration..... | 79 |
| 5-2-20 | MAC IPv4 Network Configuration | 80 |
| 5-2-21 | MAC IPv6 Network Configuration..... | 81 |
| 5-3 | AMD CBS Menu..... | 82 |
| 5-3-1 | CPU Common Options..... | 83 |
| 5-3-2 | DF Common Options..... | 89 |
| 5-3-3 | UMC Common Options | 97 |
| 5-3-4 | NBIO Common Options..... | 117 |
| 5-3-5 | FCH Common Options | 129 |
| 5-3-6 | SOC Miscellaneous Control | 137 |
| 5-3-7 | CXL Common Options..... | 139 |
| 5-4 | AMD PBS Menu..... | 141 |
| 5-4-1 | RAS..... | 142 |
| 5-5 | Chipset Setup Menu..... | 144 |
| 5-5-1 | North Bridge | 145 |

| | | |
|--------|---|-----|
| 5-6 | Server Management Menu..... | 146 |
| 5-6-1 | System Event Log | 148 |
| 5-6-2 | View FRU Information | 149 |
| 5-6-3 | BMC VLAN Configuration..... | 150 |
| 5-6-4 | BMC Network Configuration..... | 151 |
| 5-6-5 | IPv6 BMC Network Configuration..... | 152 |
| 5-7 | Security Menu | 153 |
| 5-7-1 | Secure Boot | 154 |
| 5-8 | Boot Menu..... | 156 |
| 5-9 | Save & Exit Menu..... | 158 |
| 5-10 | BIOS Recovery | 159 |
| 5-11 | BIOS POST Beep code (AMI standard)..... | 160 |
| 5-11-1 | PEI Beep Codes | 160 |
| 5-11-2 | DXE Beep Codes | 160 |

Chapter 1 Hardware Installation

1-1 Installation Precautions

The motherboard/system contain numerous delicate electronic circuits and components which can become damaged as a result of electrostatic discharge (ESD). Prior to installation, carefully read the service guide and follow these procedures:









- Prior to installation, do not remove or break motherboard S/N (Serial Number) sticker or warranty sticker provided by your dealer. These stickers are required for warranty validation.
- Always remove the AC power by unplugging the power cord from the power outlet before installing or removing the motherboard or other hardware components.
- When connecting hardware components to the internal connectors on the motherboard, make sure they are connected tightly and securely.
- When handling the motherboard, avoid touching any metal leads or connectors.
- It is best to wear an electrostatic discharge (ESD) wrist strap when handling electronic components such as a motherboard, CPU or memory. If you do not have an ESD wrist strap, keep your hands dry and first touch a metal object to eliminate static electricity.
- Prior to installing the motherboard, please have it on top of an antistatic pad or within an electrostatic shielding container.
- Before unplugging the power supply cable from the motherboard, make sure the power supply has been turned off.
- Before turning on the power, make sure the power supply voltage has been set according to the local voltage standard.
- Before using the product, please verify that all cables and power connectors of your hardware components are connected.
- To prevent damage to the motherboard, do not allow screws to come in contact with the motherboard circuit or its components.
- Make sure there are no leftover screws or metal components placed on the motherboard or within the computer casing.
- Do not place the computer system on an uneven surface.
- Do not place the computer system in a high-temperature environment.
- Turning on the computer power during the installation process can lead to damage to system components as well as physical harm to the user.
- If you are uncertain about any installation steps or have a problem related to the use of the product, please consult a certified computer technician.







1-2 Product Specifications



NOTE:

We reserve the right to make any changes to the product specifications and product-related information without prior notice.

| | | |
|---|-------------------------|--|
|  | System Dimension | <ul style="list-style-type: none"> ◆ 2U ◆ 438mm (W) x 87.5mm (H) x 710mm (D) |
|  | CPU | <ul style="list-style-type: none"> ◆ AMD EPYC™ 9005 Series Processors ◆ AMD EPYC™ 9004 Series Processors ◆ Single processor, cTDP up to 400W ^[1] <ul style="list-style-type: none"> - At 25°C ambient, cTDP up to 500W - At 30°C ambient, cTDP up to 500W with optional heatsink <p>^[1] Please refer to the QVL on the support page or contact our sales representatives for verified CPU SKUs.</p> |
|  | Socket | <ul style="list-style-type: none"> ◆ 1 x LGA 6096 ◆ Socket SP5 |
|  | Chipset | <ul style="list-style-type: none"> ◆ System on Chip |
|  | Security | <ul style="list-style-type: none"> ◆ UEFI Secure Boot ◆ Silicon root of trust (Option) ◆ SNMP Support: V3 |
|  | Memory | <ul style="list-style-type: none"> ◆ 12 x DIMM slots ◆ DDR5 memory supported ◆ 12-Channel memory architecture ◆ AMD EPYC™ 9005: RDIMM: Up to 6000 MT/s ◆ AMD EPYC™ 9004: RDIMM: Up to 4800 MT/s |
|  | LAN | <p>Rear:</p> <ul style="list-style-type: none"> ◆ 1 x 1Gb/s LAN (1 x Intel® I210-AT) ◆ Supports NCSI function ◆ 1 x 10/100/1000 Mbps Management LAN |
|  | Video | <ul style="list-style-type: none"> ◆ Integrated in Aspeed® AST2600 - 1 x Mini-DP |

| | | |
|---|-----------------|--|
|  | Storage | <p>Front hot-swap:</p> <ul style="list-style-type: none"> ◆ 4 x 3.5"/2.5" Gen5 NVMe/SATA/SAS-4^[1] ◆ 8 x 3.5"/2.5" SATA/SAS-4^[2] <p>Rear hot-swap:</p> <ul style="list-style-type: none"> ◆ 8 x 3.5"/2.5" Gen5 NVMe^[3] <p>Internal M.2:</p> <ul style="list-style-type: none"> ◆ 1 x M.2 (2280/22110), PCIe Gen3 x4 <p>^[1] Storage card is required to support SATA and SAS drives. ^[2] SAS card is required to support SAS drives. ^[3] NVMe supported only.</p> |
|  | SAS | <ul style="list-style-type: none"> ◆ Require SAS add-in cards |
|  | SAS | <ul style="list-style-type: none"> ◆ Require RAID add-in cards |
|  | Expansion Slot | <ul style="list-style-type: none"> ◆ Riser Card CRC1012: <ul style="list-style-type: none"> - 1 x FHHL x16 (Gen5 x16) ◆ Riser Card CRC1013: <ul style="list-style-type: none"> - 1 x FHHL x16 (Gen5 x16) ◆ PCIe Cable x 2: <ul style="list-style-type: none"> - 2 x FHHL x16 (Gen5 x16) ◆ 2 x OCP NIC 3.0 (Gen5 x16) <ul style="list-style-type: none"> - Support NCSI function |
|  | Front I/O | <ul style="list-style-type: none"> ◆ 2 x USB 3.2 Gen1 ports (Type-A) ◆ 1 x Power button with LED ◆ 1 x ID button with LED ◆ 1 x NMI button ◆ 1 x Reset button ◆ 2 x LAN activity LEDs (1 x LED disabled) ◆ 1 x Storage activity LED ◆ 1 x System status LED |
|  | Rear I/O | <ul style="list-style-type: none"> ◆ 2 x USB 3.2 Gen1 ports (Type-A) ◆ 1 x Mini-DP ◆ 1 x RJ45 port ◆ 1 x MLAN port ◆ 1 x ID button with LED |
|  | Backplane Board | <p>Speed and bandwidth:</p> <ul style="list-style-type: none"> ◆ Front side - CBP20C7: PCIe Gen5 x4 or SATA 6Gb/s or SAS-4 24Gb/s ◆ Rear side - CBP20S5: PCIe Gen5 x4 |



Security Modules

- ◆ 1 x TPM header with SPI interface
 - **Optional** TPM2.0 kit: CTM012



Power Supply

R263-Z37-AAC1

- ◆ 2 x 1300W 80 PLUS Platinum redundant power supply
- ◆ AC Input:
 - 100-240V~/ 12-7A, 50-60Hz
 - 200-240V~/ 8A, 50-60Hz
- ◆ DC Input: (Only for China)
 - 240Vdc/ 6.5A
- ◆ DC Output:
 - Max 1000W/ 100-240V~
 - +12V/ 80.5A
 - +12Vsb/ 3A
 - Max 1300W/ 200-240V~ or 240Vdc Input
 - +12V/ 105.4A
 - +12Vsb/ 3A

R263-Z37-AAH1

- ◆ 2 x 1300W 80 PLUS Titanium redundant power supply
- ◆ AC Input:
 - 100-127V~/ 12A, 50-60Hz
 - 200-240V~/ 8A, 50-60Hz
- ◆ DC Input: (Only for China)
 - 240Vdc/ 7A
- ◆ DC Output:
 - Max 1000W/ 100-127V~
 - +12.2V/ 82A
 - +12.2Vsb/ 3A
 - Max 1300W/ 200-240V~ or 240Vdc Input
 - +12.2V/ 106A
 - +12.2Vsb/ 3A

[Note] GIGABYTE offers PSUs with various efficiency ratings and power outputs. Full redundancy may depend on your server configuration, and alternative PSU options may be needed. Please contact our sales representatives for the best power solution.



System Management

- ◆ Aspeed® AST2600 Baseboard Management Controller
- ◆ GIGABYTE Management Console web interface

- ◆ Dashboard
- ◆ HTML5 KVM
- ◆ Sensor Monitor (Voltage, RPM, Temperature, CPU Status ...etc.)
- ◆ Sensor Reading History Data
- ◆ FRU Information
- ◆ SEL Log in Linear Storage / Circular Storage Policy
- ◆ Hardware Inventory
- ◆ Fan Profile
- ◆ System Firewall
- ◆ Power Consumption
- ◆ Power Control
- ◆ Advanced power capping
- ◆ LDAP / AD / RADIUS Support
- ◆ Backup & Restore Configuration
- ◆ Remote BIOS/BMC/CPLD Update
- ◆ Event Log Filter
- ◆ User Management
- ◆ Media Redirection Settings
- ◆ PAM Order Settings
- ◆ SSL Settings
- ◆ SMTP Settings



Operating Properties

- ◆ Operating temperature: 10°C to 35°C
- ◆ Operating humidity: 8-80% (non-condensing)
- ◆ Non-operating temperature: -40°C to 60°C
- ◆ Non-operating humidity: 20%-95% (non-condensing)

Chapter 2 System Appearance

2-1 Front View

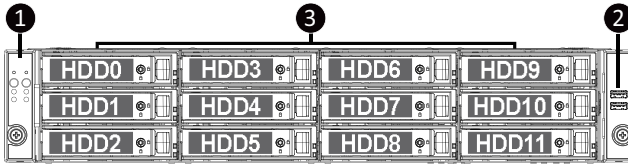

| No. | Description |
|--|------------------------------|
| 1. | Front Panel LEDs and Buttons |
| 2. | Front USB 3.2 Gen1 Ports |
| 3. | 3.5"/2.5" Drive Bays |
| Note! Drives with green latches support NVMe. | |



- Please Go to Chapter 2-3 Front Panel LED and Buttons for detail description of function LEDs.

2-2 Rear View

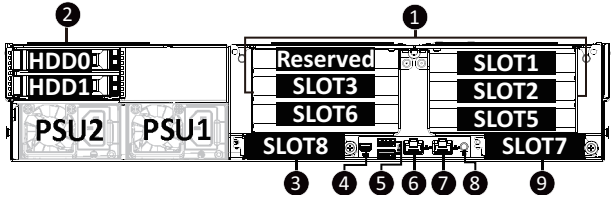

| No. | Description |
|-----|--|
| 1. | PCIe Slot |
| 2. | 2.5" drive bays |
| 2. | OCP 3.0 Slot (Option/SFF) |
| 3. | Mini DisplayPort |
| 4. | USB 3.2 Gen1 Port x 2 |
| 5. | 10/100/1000 Server Management LAN Port |
| 6. | 1GbE LAN Port |
| 7. | ID Button |
| 8. | OCP 3.0 Slot (Option/SFF) |

2-3 Front Panel LEDs and Buttons

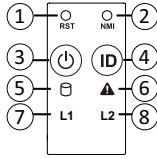

| No. | Name | Color | Status | Description |
|-----|-------------------------------------|--|----------|---|
| 1. | Reset Button | | | Press the button to reset the system. |
| 2. | NMI button | | | Press the button server generates a NMI to the processor if the multiple-bit ECC errors occur, which effectively halt the server. |
| 3. | Power button with LED | Green | On | System is powered on |
| | | Green | Blink | System is in ACPI S1 state (sleep mode) |
| | | N/A | Off | <ul style="list-style-type: none"> System is not powered on or in ACPI S5 state (power off) System is in ACPI S4 state (hibernate mode) |
| 4. | ID Button ^(Note) | | | Press the button to activate system identification |
| 5. | HDD Status LED | Green | On | HDD locate |
| | | | Blink | HDD access |
| | | Amber | On | HDD fault |
| | | Green/Amber | Blink | HDD rebuilding |
| | | N/A | Off | No HDD access or no HDD fault. |
| 6. | System Status LED ^(Note) | Green | Solid On | System is operating normally. |
| | | | Amber | Solid On |
| | | Blink | | Non-critical condition, may indicate: Redundant power module failure Temperature and voltage issue Chassis intrusion |
| N/A | Off | System is not ready, may indicate: POST error; NMI error; Processor or terminator missing | | |
| 7. | LAN 1 Active/Link LED | Green | Solid On | Link between system and network or no access. |
| | | | Blink | Data transmission or receiving is occurring |
| | | N/A | Off | No data transmission or receiving is occurring |
| 8. | LAN 2 Active/Link LED | | | The function is disabled. |

(Note) If your server features RoT function, please see the following section for detail LED behavior.

2-3-1 RoT LEDs

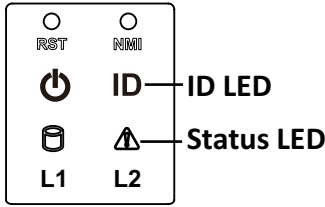

| LED on Front panel ^(Note5) | | |
|---|--------------------------------------|---------------------------------------|
| | ID LED | Status LED |
| EC Firmware (FW) Authentication fail or not exit | | |
| EC FW is broken or not exit ^(Note1) | OFF | OFF |
| Authenticating/Recovering BMC/BIOS Images | | |
| Authenticating Images | OFF | OFF |
| Recovering BMC Active Flash | Blinks Blue 4 times per second | Blinks Green 4 times per second |
| Recovering BIOS Active Flash | Blinks Blue 4 times per second | Blinks Green 4 times per second |
| Authentication (AUTH) Pass | | |
| Recovering BIOS Active Flash | OFF | OFF |
| BMC : AUTH pass after doing recovery | OFF | OFF |
| BIOS : AUTH pass after doing recovery | OFF | OFF |
| BMC : AUTH pass | OFF | OFF |
| BIOS : AUTH pass after doing recovery | OFF | OFF |
| Active Flash Authentication (AUTH) Fail | | |
| BMC : AUTH Fail ^(Note2) | Blinks Blue 1 time per second | Blinks Green 1 time per second |

| | | |
|--|--|---|
| BIOS : AUTH fail^(Note2) | Blinks Blue 1 time per second | Blinks Amber 1 time per second |
| BMC : AUTH fail after doing recovery^(Note3) | Blinks Blue 2 times per second [ON OFF OFF] | Blinks Green 2 times per second [ON OFF OFF] |
| BIOS : AUTH fail after doing recovery^(Note3) | Blinks Blue 2 times per second [ON OFF OFF] | Blinks Amber 2 times per second [ON OFF OFF] |
| Backup Flash Authentication Fail^(Note4) | | |
| BMC : AUTH fail | Blinks Blue 2 times per second [ON OFF ON OFF] | Blinks Green 2 times per second [ON OFF ON OFF] |
| BIOS : AUTH fail | Blinks Blue 2 times per second [ON OFF ON OFF] | Blinks Amber 2 times per second [ON OFF ON OFF] |

NOTE!

1. EC FW is broken or not exited result in Microchip CEC1702 cannot load EC FW for authentication.
2. (1) Authentication fail include below scenarios
Configuration table is missing or modified
Public key is missing or modified
Protected area or signature is modified
Flash empty
3. If active flash is still authentication failed after recovery sequence, Microchip CEC1702 stop the process and showing LED behavior.
4. If backup flash authentication is failed cause by configuration table, public key or protected area is broken. Microchip CEC1702 stop the process and showing LED behavior.
5. Front panel LED is controlled by BMC or Microchip CEC1702. Once Microchip CEC1702 is working(Auth or recovery), the front panel LED is controlled by Microchip CEC1702 and vice versa.

2-4 Rear System LAN LEDs

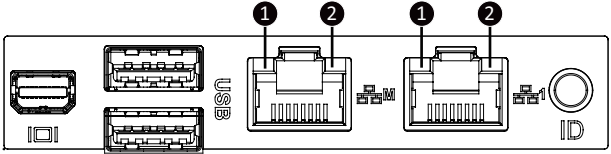

| No. | Name | Color | Status | Description |
|-----|------------------------|--------|--------|--|
| 1. | 1GbE Speed LED | Yellow | On | 1 Gbps data rate |
| | | Green | On | 100 Mbps data rate |
| | | N/A | Off | 10 Mbps data rate |
| 2. | 1GbE Link/Activity LED | Green | On | Link between system and network or no access |
| | | N/A | Blink | Data transmission or receiving is occurring |
| | | N/A | Off | No data transmission or receiving is occurring |

2-5 Power Supply Unit (PSU) LED



NOTE!

The power supply may vary based on the system configuration.

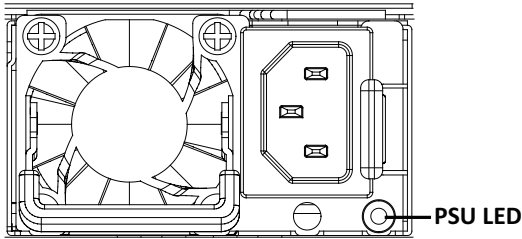

| State | Description |
|--------------------|---|
| OFF | No AC power to all power supplies |
| 1Hz Green Blinking | AC present / only standby on / Cold redundant mode |
| 2Hz Green Blinking | Power supply firmware updating mode |
| Amber | AC cord unplugged or AC power lost; with a second power supply in parallel still with AC input power |
| | Power supply critical event causing shut down: failure, OCP, OVP, fan failure and UVP |
| 1Hz Amber Blinking | Power supply warning events where the power supply continues to operate: high temp, high power, high current and slow fan |

2-6 Hard Disk Drive LEDs

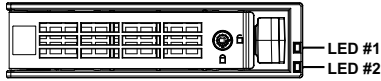

| RAID SKU | | LED #1 | Locate | HDD Fault | Rebuilding | HDD Access | HDD Present (No Access) |
|---|--------------------------------------|--------|--------|-----------|-------------------|------------|-------------------------|
| No RAID configuration (via HBA) | Disk LED (LED on Back Panel) | Green | ON(*1) | OFF | | BLINK (*2) | OFF |
| | | Amber | OFF | OFF | | OFF | OFF |
| | Removed HDD Slot (LED on Back Panel) | Green | ON(*1) | OFF | | -- | -- |
| | | Amber | OFF | OFF | | -- | -- |
| RAID configuration (via HW RAID Card or SW RAID Card) | Disk LED | Green | ON | OFF | | BLINK (*2) | OFF |
| | | Amber | OFF | ON | (Low Speed: 2 Hz) | OFF | OFF |
| | Removed HDD Slot | Green | ON(*1) | OFF | (*3) | -- | -- |
| | | Amber | OFF | ON | (*3) | -- | -- |

| LED #2 | HDD Present | No HDD |
|--------|-------------|--------|
| Green | ON | OFF |

NOTE:

*1: Depends on HBA/Utility Spec.

*2: Blink cycle depends on HDD's activity signal.

*3: If HDD is pulled out during rebuilding, the disk status of this HDD is regarded as faulty.

Chapter 3 System Hardware Installation



Pre-installation Instructions

Computer components and electronic circuit boards can be damaged by electrostatic discharge. Working on computers that are still connected to a power supply can be extremely dangerous. Follow the simple guidelines below to avoid damage to your computer or injury to yourself.

- Always disconnect the computer from the power outlet whenever you are working inside the computer case.
- If possible, wear a grounded wrist strap when you are working inside the computer case. Alternatively, discharge any static electricity by touching the bare metal system of the computer case, or the bare metal body of any other grounded appliance.
- Hold electronic circuit boards by the edges only. Do not touch the components on the board unless it is necessary to do so. Do not flex or stress the circuit board.
- Leave all components inside the static-proof packaging until you are ready to use the component for the installation.

3-1 Removing Chassis Cover



Before you remove or install the system cover

- Make sure the system is not turned on or connected to AC power.

Follow these instructions to remove the chassis cover:

1. Remove the screw securing the chassis cover.
2. Push button to unlock the handle.
3. Pull the grip handle to open the panel cover.
4. Slide the chassis cover towards the rear and remove the chassis cover in the direction indicated.
5. To reinstall the chassis cover reverse steps 1-4.

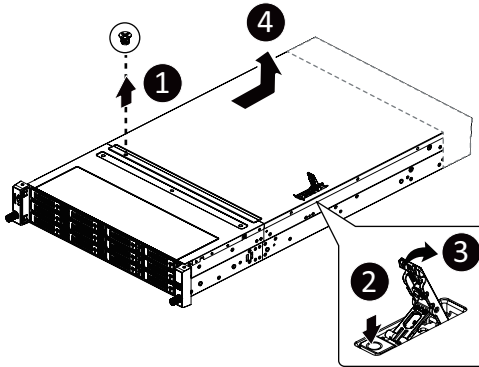

3-2 Removing and Installing the Fan Duct

Follow these instructions to remove/install the fan duct:

1. Lift up to remove the fan duct
2. To install the fan duct, align the fan duct with the guiding groove. Push down the fan duct into chassis until its firmly seat.

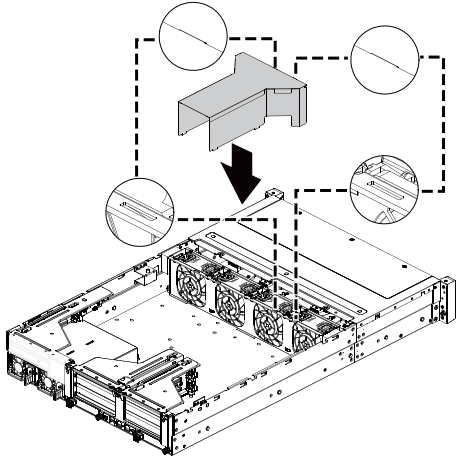
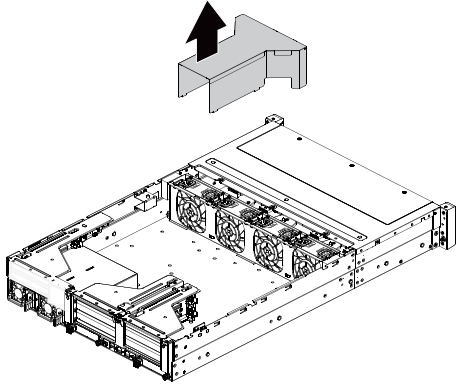

3-3 Removing and installing the Heat Sink



Read the following guidelines before you begin to remove/install the heat sink:

- Always turn off the computer and unplug the power cord from the power outlet before installing the heat sink to prevent hardware damage.
- Unplug all cables from the power outlets.
- Disconnect all telecommunication cables from their ports.
- Place the system unit on a flat and stable surface.
- Open the system according to the instructions.



WARNING!

Failure to turn off the server before you start installing components may cause serious damage. Do not attempt the procedures described in the following sections unless you are a qualified service technician.

Follow these instructions to remove/install the heat sink:

1. Loosen the captive screws securing the heat sink in place in reverse order (6→5→4→3→2→1).
2. Lift and remove the heat sink from the system.
3. To reinstall the heat sink reverse steps 1-2 while ensuring that you tighten the captive screws in sequential order (1→2→3→4→5→6) as seen in the image below.

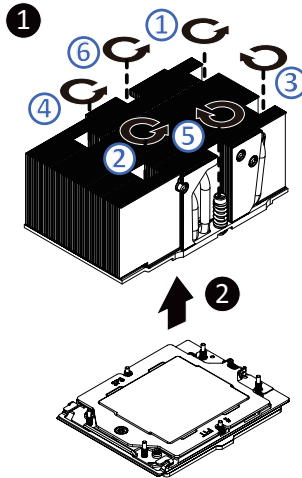

- When installing the heat sink to CPU, use a Torx T20 screwdriver to tighten 6 captive nuts in sequence as 1-6. Please refer to the Heatsink Label for the screw tightening torque value.
- To ensure the system operates properly, make sure the heat sink is seated on the processor firmly.

3-4 Installing the CPU



Read the following guidelines before you begin to install the CPU:

- Make sure that the motherboard supports the CPU.
- Always turn off the computer and unplug the power cord from the power outlet before installing the CPU to prevent hardware damage.
- Unplug all cables from the power outlets.
- Disconnect all telecommunication cables from their ports.
- Place the system unit on a flat and stable surface.
- Open the system according to the instructions.



WARNING!

Failure to properly turn off the server before you start installing components may cause serious damage. Do not attempt the procedures described in the following sections unless you are a qualified service technician.

Follow these instructions to install the CPU:

1. Loosen the captive screw securing the CPU cover.
2. Flip open the CPU cover.
3. Remove the CPU carrier from the CPU frame using the handle on the CPU carrier.
4. Using the handle on the CPU carrier insert the new CPU carrier with CPU installed into the CPU frame.

NOTE: Ensure the CPU is installed in the CPU carrier in the correct orientation, with the triangle on the CPU aligned to the top left corner of the CPU carrier.

5. Flip the CPU frame with CPU installed into place in the CPU socket.
6. Flip the CPU cover into place over the CPU socket.
7. Tighten the CPU cover screw to secure the CPU cover in place.

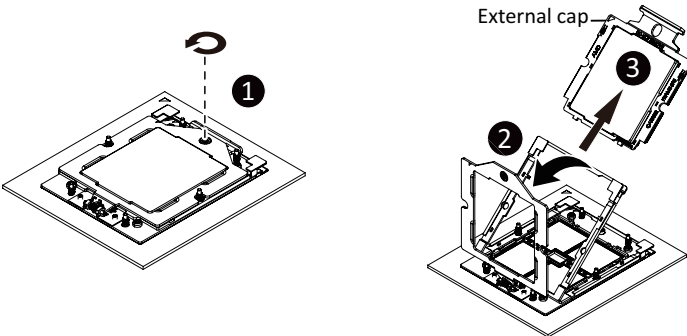

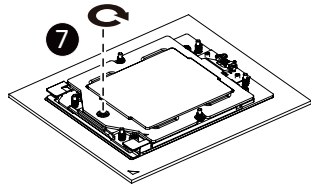
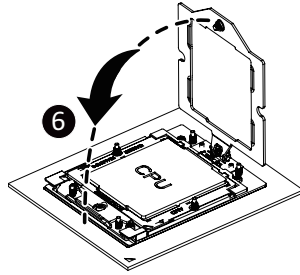
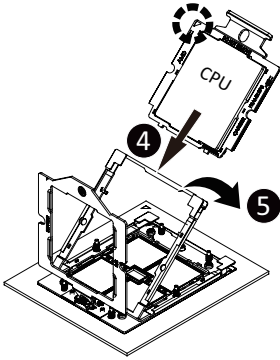

- Lock the CPU by using a Torx T20 screwdriver to tighten screw.
- The screw tightening torque: 12.5-15.0 kgf-cm.

3-5 Installing the Memory



Read the following guidelines before you begin to install the memory:

- Make sure that the motherboard supports the memory. It is recommended that memory of the same capacity, brand, speed, and chips be used.
- Always turn off the computer and unplug the power cord from the power outlet before installing the memory to prevent hardware damage.
- Memory modules have a foolproof design. A memory module can be installed in only one direction. If you are unable to insert the memory, switch the direction.

3-5-1 Twelve Channel Memory Configuration

This motherboard provides 12 DDR5 memory slots and supports 12 Channel Technology. After the memory is installed, the BIOS will automatically detect the specifications and capacity of the memory.

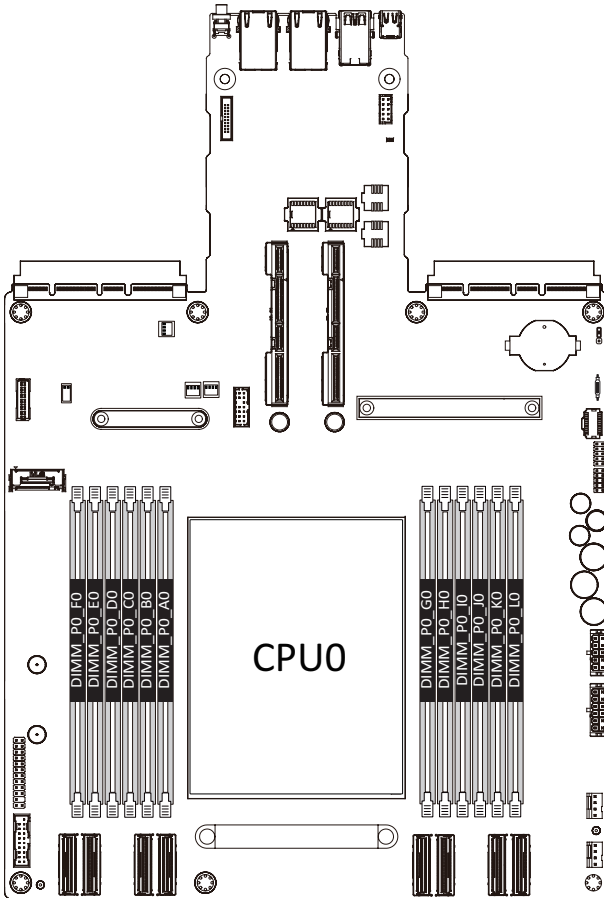

3-5-2 Installing the Memory



Before installing a memory module, make sure to turn off the computer and unplug the power cord from the power outlet to prevent damage to the memory module.

Be sure to install DDR5 DIMMs on this motherboard.

Make sure your DIMM slots have a single latch or a double latch.

Follow these instructions to install a DIMM module with Single Latch :

1. Open the plastic latch of the memory slot, then place the memory module as pre-inserted vertically position.

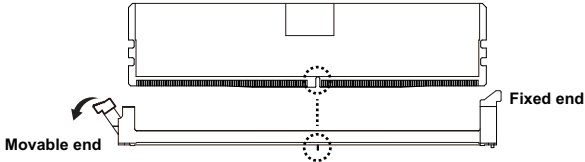

2. Hold it with both hands, insert the memory module into the movable end first, and then insert the memory module into the fixed end.

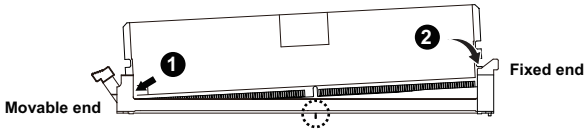

3. Then use both hands to insert the memory module vertically into the DIMM slot and push it down. Close the plastic latch at the edge of the DIMM slots to lock the memory module.

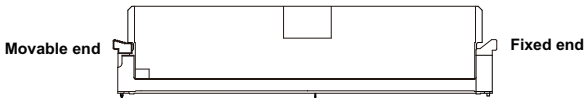

4. Reverse the installation steps when you want to remove the memory module.

Follow these instructions to install the Memory:

1. Insert the DIMM memory module vertically into the DIMM slot, and push it down.
2. Close the plastic clip at both edges of the DIMM slots to lock the DIMM module.
3. Reverse the installation steps when you want to remove the DIMM module.

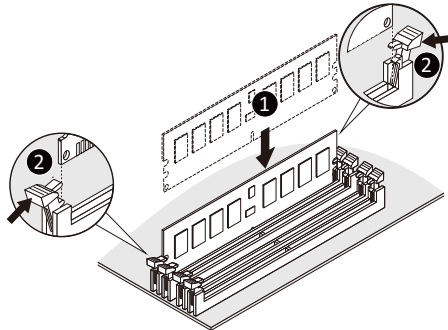

3-5-3 Processor and Memory Module Matrix Table

| Memory Q'ty | CPU0 | | | | | | | | | | | |
|-------------|------|----|----|----|----|----|----|----|----|----|----|----|
| | F0 | E0 | D0 | C0 | B0 | A0 | G0 | H0 | I0 | J0 | K0 | L0 |
| 1 DIMM | | | | | | v | | | | | | |
| 2 DIMM | | | | | | v | v | | | | | |
| 4 DIMM | | | | v | | v | v | | v | | | |
| 6 DIMM | | | | v | v | v | v | v | v | | | |
| 8 DIMM | | v | | v | v | v | v | v | v | | v | |
| 10 DIMM | | v | v | v | v | v | v | v | v | v | v | |
| 12 DIMM | v | v | v | v | v | v | v | v | v | v | v | v |

3-5-4 DIMM Population Table

EPYC Memory Speed based on DIMM Population (One DIMM per Channel)

| DIMM Type | DIMM Population | DDR5 Frequency MT/s ^{1,2} | | |
|---------------------------|-----------------|------------------------------------|-----------------------------------|-----------------------------------|
| | | 6400 MT/s Grade DIMM ³ | 5600 MT/s Grade DIMM ³ | 4800 MT/s Grade DIMM ³ |
| RDIMM | 1R (1 rank) | 6000 | 5600 | 4800 |
| | 2R (2 ranks) | 6000 | 5600 | 4800 |
| 3DS RDIMM* | 2R xH | 6000 ⁴ | 5600 | 4800 |
| MRDIMM (1:1) ⁵ | 4R (4 ranks) | 6000 ⁴ | | |

| | | |
|----------------|-------------------------|-----------------|
| *For 3DS RDIMM | When x = 2 | DIMM Ranks = 4 |
| | When x = 4 | DIMM Ranks = 8 |
| | When x = 8 ⁵ | DIMM Ranks = 16 |

NOTE!

- When only one DIMM is used, it must be populated in memory slot DIMM1.
4. Frequency subject to change based on validation.
 5. Maximum frequency references 14L 74mil low-Dk PCB stackup.
 6. 6000 MT/s pending ecosystem enablement.
 7. MRDIMM will be evaluated as a post-PR feature, pending ecosystem readiness.
 8. 3DS RDIMM at 2 Rank (8H DRAM Pkgs) will be a post-PR feature, pending ecosystem.

3-6 Installing the PCI Expansion Card



- Voltages can be present within the server whenever an AC power source is connected. This voltage is present even when the main power switch is in the off position. Ensure that the system is powered-down and all power sources have been disconnected from the server prior to installing a PCIe card.

- Failure to observe these warnings could result in personal injury or damage to equipment.



- The PCIe riser assembly does not include a riser card or any cabling as standard. To install a PCIe card, a riser card must be installed.

Follow these instructions for a PCI Expansion card:

1. Remove the screws and loosen the thumbscrew securing the riser bracket.
2. Lift up the riser bracket out of system.
3. Remove the screw securing the slot cover from the riser bracket.
4. Remove the slot covers from the riser bracket.
5. Orient the PCIe card with the riser guide slot and push in the direction of the arrow until the PCIe card sits in the PCIe card connector.
6. Secure the PCIe card with the screw.
7. Reverse the previous steps to install the riser bracket.

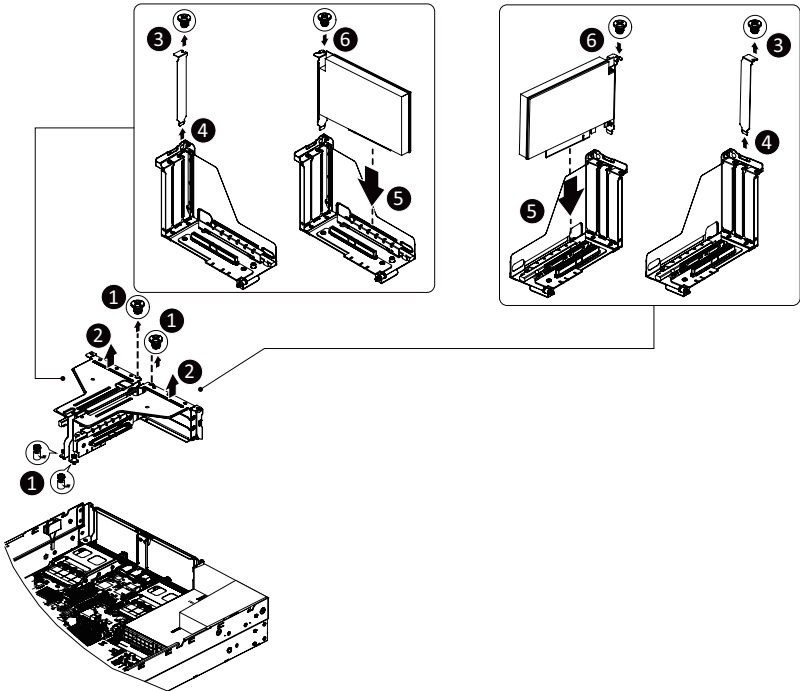

3-7 Installing the Mezzanine Card

3-7-1 OCP 3.0



Use of the following type of OCP 3.0 NIC is recommended:

- OCP 3.0 SFF with Pull Tab
- OCP 3.0 SFF with Ejector Latch

Follow these instructions to install an OCP 3.0 mezzanine card:

1. Remove the two screws securing the mezzanine card slot cover.
2. Remove the slot cover from the system.
3. Insert the OCP 3.0 mezzanine card into the card slot ensuring that the card is firmly connected to the connector on the motherboard.
4. Tighten the thumbnail screw to secure the OCP 3.0 mezzanine card in place.
5. Reverse the previous steps to replace the OCP 3.0 mezzanine card.

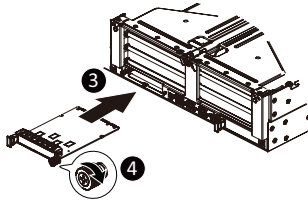
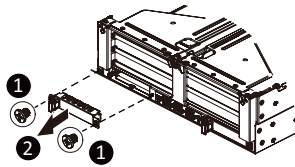

3-8 Installing the Hard Disk Drive



Read the following guidelines before you begin to install the HDD:

- Take note of the drive tray orientation before sliding it out.
- The tray will not fit back into the bay if inserted incorrectly.
- Make sure that the HDD is connected to the HDD connector on the backplane.

Follow these instructions to install a 3.5" HDD:

1. Press the release button.
2. Extend the locking lever.
3. Pull the locking lever in the direction indicated to remove the HDD tray.
4. Slide the hard disk drive into the HDD tray.
5. Reinsert the HDD tray into the slot and close the locking lever.

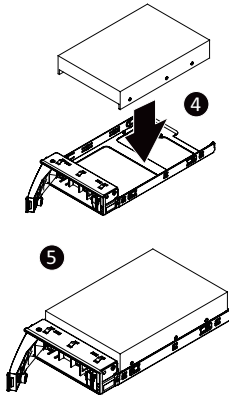
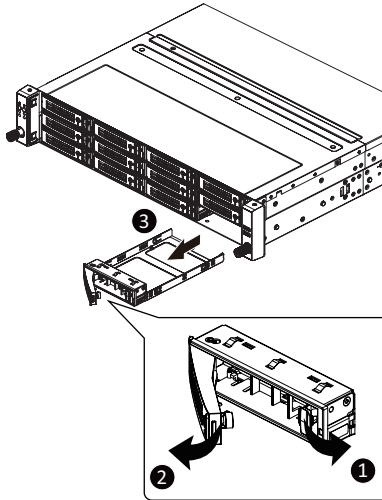

Follow these instructions to install 2.5" hard disk drive into 3.5" HDD Tray:

- 1. Press the release button.
- 2. Extend the locking lever.
- 3. Pull the locking lever in the direction indicated to remove the HDD tray.
- 4. Align the hard disk drive with the positioning screw on the HDD tray.
- 5. Secure the hard disk drive with five screws.
- 6. Reinsert the HDD tray into the slot and close the locking lever.

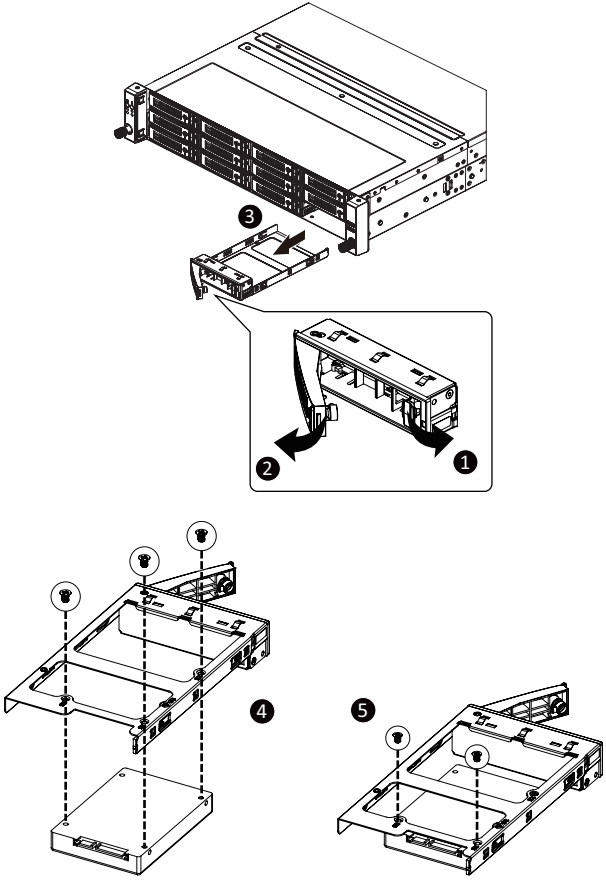

Follow these instructions to install a 2.5" HDD:

1. Press the release button.
2. Extend the locking lever.
3. Pull the locking lever in the direction indicated to remove the HDD tray.
4. Slide the hard disk drive into the HDD tray.
5. Reinsert the HDD tray into the slot and close the locking lever.

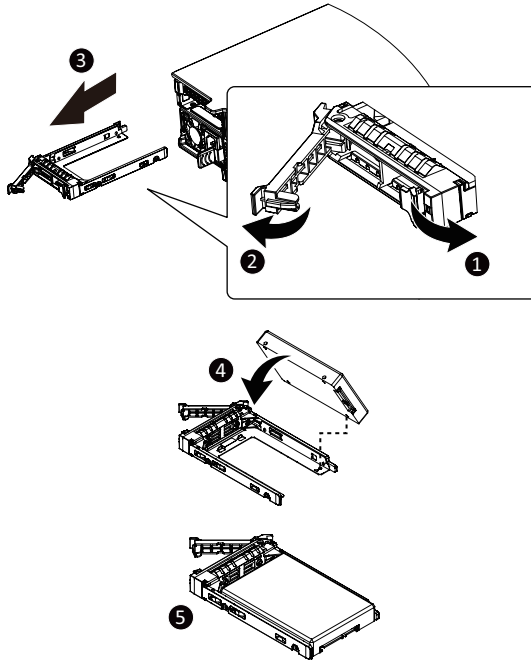

3-9 Installing the M.2 Device and Heat Sink



CAUTION

The position of the stand-off screw will depend on the size of the M.2 device. The stand-off screw is pre-installed for 22110 cards as standard. Refer to the size of the M.2 device and change the position of the stand-off screw accordingly.



WARNING:

Please ensure a heat sink is attached to any M.2 device installed into the system. Installing an M.2 device without any heat sink may result in the system overheating or system performance being throttled.



- To install/remove the M.2 module and Heat sink use a No. 1 Phillips-head screwdriver with a screw torque of 1.5 ± 0.2 kgf*cm

Follow these instructions to install the M.2 device and heat sink:

1. Insert the M.2 device into the M.2 connector.
2. Press down on the M.2 device.
3. Install the thermal pad of the M.2 device to the M.2 device.
4. Press down on the thermal pad.
5. Secure the M.2 device and its thermal pad to the motherboard with a single screw.
6. Reverse steps 1-2 to remove the M.2 device.

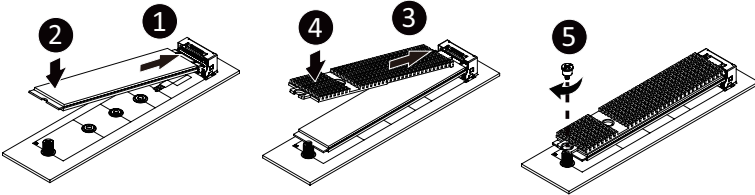

3-10 Replacing the Fan Assembly



- Voltages can be present within the server whenever an AC power source is connected. This voltage is present even when the main power switch is in the off position. Ensure that the system is powered-down and all power sources have been disconnected from the server prior to replacing a system fan.
- Failure to observe these warnings could result in personal injury or damage to equipment.

Follow these instructions to replace the fan assembly:

1. Pull outward the fan ear.
2. Lift up the fan assembly from the chassis.
3. Reverse the previous steps to install the replacement fan assembly.

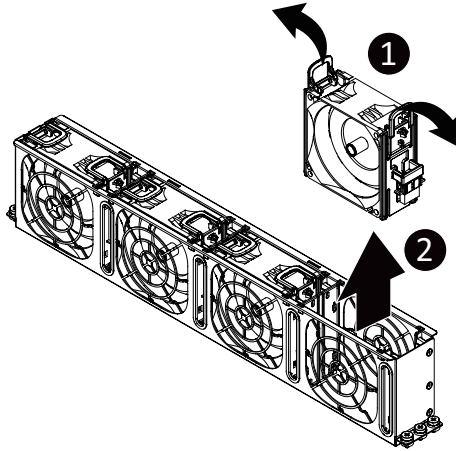

3-11 Replacing the Power Supply



CAUTION!

- In order to reduce the risk of injury from electric shock, disconnect AC power from the power supply before removing the power supply from the system

Follow these instructions to replace the power supply:

1. Flip and then grasp the power supply handle.
2. Press the retaining clip on the top side of the power supply in the direction indicated.
3. Pull out the power supply using the handle.
4. Insert the replacement power supply firmly into the chassis. Connect the AC power cord to the replacement power supply.

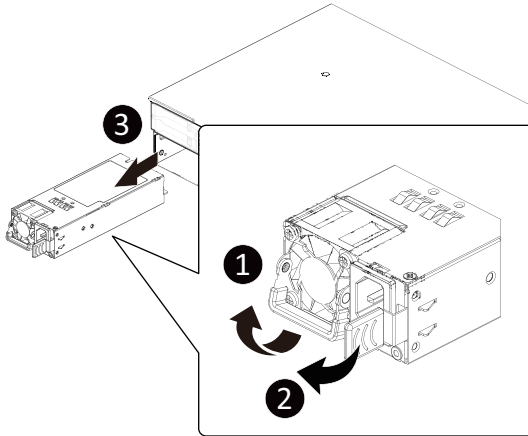

3-12 Cable Routing

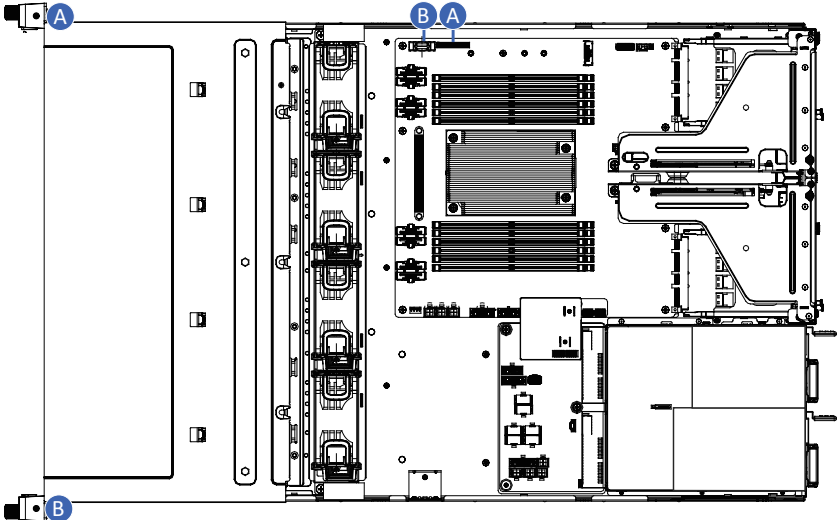

| | | |
|---|------------------------|---------------------------|
| A | Front Switch/LED Cable | Motherboard: FP_1 -- |
| B | Front USB 3 Cable | Motherboard: F_USB3 -- |

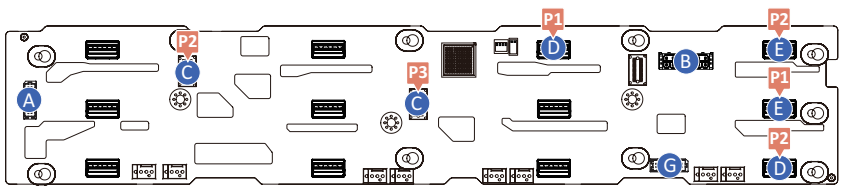
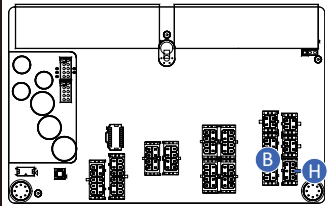
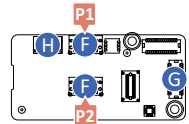
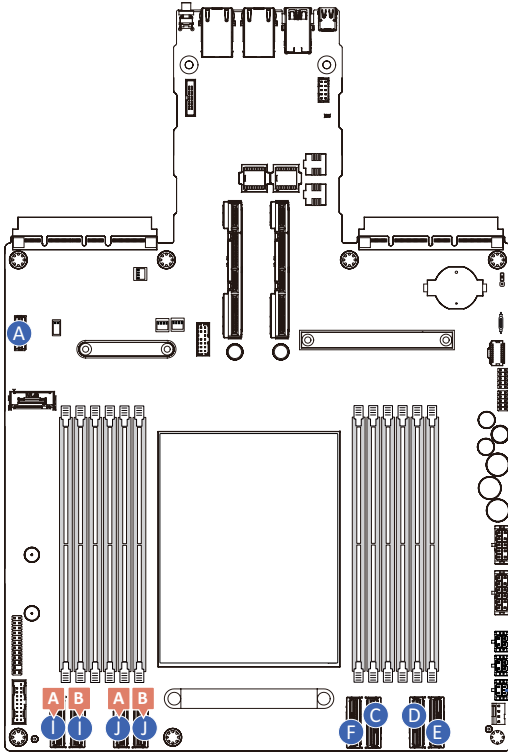
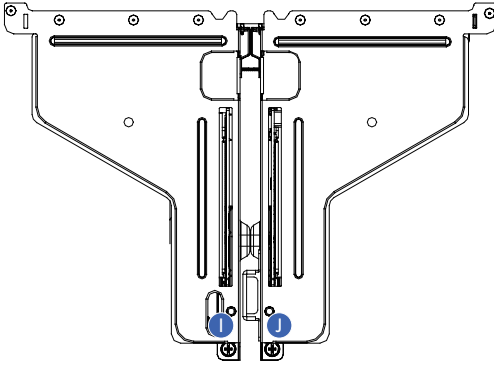

System Hardware Installation

| | | |
|---|------------------------------|---|
| A | Backplane Board Signal Cable | Motherboard: BP_1 |
| | | Backplane Board(CBP20C7): BP_1 |
| B | Backplane Board Power Cable | Power Board: BP_ATX1 |
| | | Backplane Board(CBP20C7): ATX1 |
| C | SATA Cable | Motherboard: U2_P0_G3A |
| | | Backplane Board(CBP20C7): SL_SAS0/SL_SAS1 |
| D | NVMe Cable | Motherboard: U2_P0_G2A |
| | | Backplane Board(CBP20C7): U.2 8/ U.2 9 |
| E | NVMe Cable | Motherboard: U2_P0_G2B |
| | | Backplane Board(CBP20C7): U.2 10/ U.2 11 |
| F | NVMe Cable | Motherboard: U2_P0_G3B |
| | | Backplane Board(CBP2025): U.2 0/ U.2 1 |
| G | Backplane Board Signal Cable | Backplane Board(CBP20C7) BP_SERIES |
| | | Backplane Board(CBP2025): BP_1 |
| H | Backplane Board Power Cable | Power Board: BP_ATX2 |
| | | Backplane Board(CBP2025):BP_2x3 |
| I | PCIe Slot Signal Cable | SLOT Cable |
| | | Motherboard: U2_P0_G1A/U2_P0_G1B |
| | PCIe Slot Power Cable | SLOT Power Cable |
| | | Motherboard: PCIE_PWR1 |
| J | PCIe Slot Signal Cable | SLOT Cable |
| | | Motherboard: U2_P0_G0A/U0_P0_G0B |
| | PCIe Slot Power Cable | SLOT Power Cable |
| | | Motherboard: PCIE_PWR2 |

| Item | Description |
|-------------|--|
| 1 | 2 x 5 Pin ATX Power Connector |
| 2 | 2 x 6 Pin ATX Power Connector |
| 3 | 2 x 2 Pin Slot Power Connector (PCIe_PWR3) |
| 4 | 2 x 2 Pin Slot Power Connector (PCIe_PWR2) |
| 5 | 2 x 2 Pin Slot Power Connector (PCIe_PWR1) |
| 6 | MCIO Connector (U2_P0_G2B/ U2_P0_G2A) |
| 7 | MCIO Connector (U2_P0_G3B/ U2_P0_G3A) |
| 8 | MCIO Connector (U2_P0_G0A/ U2_P0_G0B) |
| 9 | MCIO Connector (U2_P0_G1A /U2_P0_G1B) |
| 10 | Front Panel USB 3.2 Gen1 Connector |
| 11 | Front Panel Connector |
| 12 | M.2 Slot (PCIe Gen3 x4, NGFF-22110) |
| 13 | HDD Backplane Board Connector |
| 14 | OCP 3.0 Connector (PCIe Gen5 x16) |
| 15 | TPM Module Connector (SPI Interface) |
| 16 | NCSI Connector |
| 17 | Riser Connector #1 (PCIe Gen5/x16 Slot) |
| 18 | Riser Connector #2 (PCIe Gen5/x16 Slot) |
| 19 | BMC Readiness LED |
| 20 | OCP 3.0 Connector (PCIe Gen5 x16) |
| 21 | System Battery |

4-2 Jumper Setting

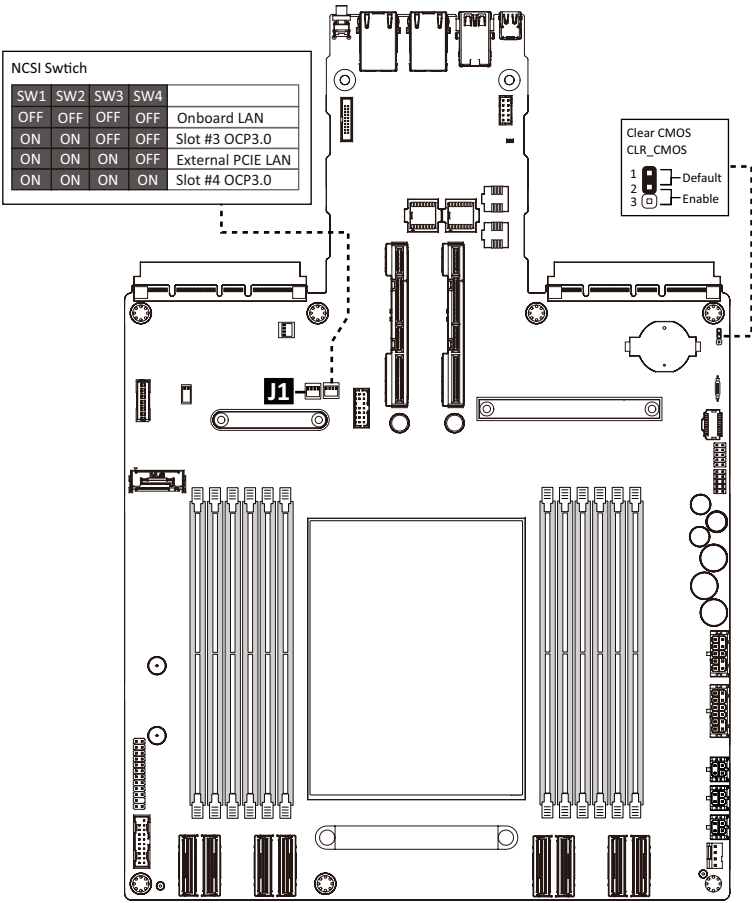

| J1 | | ON | OFF |
|----|----------------|---------------------------|------------------|
| 1 | HSMB_SEL | BIOS defined | |
| 2 | PMBUS_SEL | BIOS defined | |
| 3 | BIOS_PWD_CLEAR | Clear supervisor password | Normal [Default] |
| 4 | BIOS_RCVR | BIOS recovery mode | Normal [Default] |

4-3 Backplane Board Storage Connector

4-3-1 CBP20C7

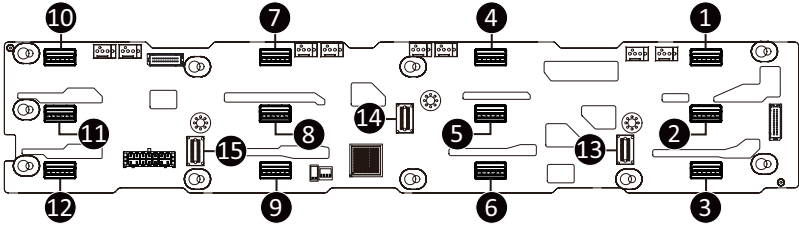

| Item | Description |
|------|---|
| 1. | MCIO 4i (SFF-TA-1016 / U.2_0) |
| 2. | MCIO 4i (SFF-TA-1016 / U.2_1) |
| 3. | MCIO 4i (SFF-TA-1016 / U.2_2) |
| 4. | MCIO 4i (SFF-TA-1016 / U.2_3) |
| 5. | MCIO 4i (SFF-TA-1016 / U.2_4) |
| 6. | MCIO 4i (SFF-TA-1016 / U.2_5) |
| 7. | MCIO 4i (SFF-TA-1016 / U.2_6) |
| 8. | MCIO 4i (SFF-TA-1016 / U.2_7) |
| 9. | MCIO 4i (SFF-TA-1016 / U.2_8) |
| 10. | MCIO 4i (SFF-TA-1016 / U.2_9) |
| 11. | MCIO 4i (SFF-TA-1016 / U.2_10) |
| 12. | MCIO 4i (SFF-TA-1016 / U.2_11) |
| 13. | SlimSAS 4i Connector (SFF-8654 / SL_SAS0) |
| 14. | SlimSAS 4i Connector (SFF-8654 / SL_SAS1) |
| 15. | SlimSAS 4i Connector (SFF-8654 / SL_SAS2) |

4-3-2 CBP2025 (Rear System Storage Board)

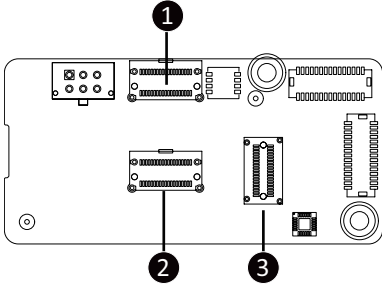

| Item | Description |
|------|---|
| 1 | MCIO 4i (SFF-TA1016 / U_2_0) |
| 2 | MCIO 4i (SFF-TA1016 / U_2_1) |
| 3 | SlimSAS 4i Connector (SFF-8654 / SL_SAS0) |

Chapter 5 BIOS Setup

BIOS (Basic Input and Output System) records hardware parameters of the system in the EFI on the motherboard. Its major functions include conducting the Power-On Self-Test (POST) during system startup, saving system parameters, loading the operating system etc. The BIOS includes a BIOS Setup program that allows the user to modify basic system configuration settings or to activate certain system features. When the power is turned off, the battery on the motherboard supplies the necessary power to the CMOS to keep the configuration values in the CMOS.

To access the BIOS Setup program, press the key during the POST when the power is turned on.



- BIOS flashing is potentially risky, if you do not encounter any problems when using the current BIOS version, it is recommended that you don't flash the BIOS. To flash the BIOS, do it with caution. Inadequate BIOS flashing may result in system malfunction.
- It is recommended that you not alter the default settings (unless you need to) to prevent system instability or other unexpected results. Inadequately altering the settings may result in system's failure to boot. If this occurs, try to clear the CMOS values and reset the board to default values. (Refer to the **Exit** section in this chapter or introductions of the battery/clearing CMOS jumper in Chapter 4 for how to clear the CMOS values.)

BIOS Setup Program Function Keys

| | |
|----------|--|
| <<-><->> | Move the selection bar to select the screen |
| <↑><↓> | Move the selection bar to select an item |
| <+> | Increase the numeric value or make changes |
| <-> | Decrease the numeric value or make changes |
| <Enter> | Execute command or enter the submenu |
| <Esc> | Main Menu: Exit the BIOS Setup program Submenus: Exit current submenu |
| <F1> | Show descriptions of general help |
| <F3> | Restore the previous BIOS settings for the current submenus |
| <F9> | Load the Optimized BIOS default settings for the current submenus |
| <F10> | Save all the changes and exit the BIOS Setup program |

- **Main**

This setup page includes all the items of the standard compatible BIOS.

- **Advanced**

This setup page includes all the items of AMI BIOS special enhanced features.

(ex: Auto detect fan and temperature status, automatically configure hard disk parameters.)

- **AMD CBS**

This setup page includes the common items for configuration of AMD motherboard-related information.

- **AMD PBS Option**

This setup page includes the common items for configuration of AMD CPM RAS related settings.

- **Chipset**

This setup page includes all the submenu options for configuring the functions of the North Bridge.

- **Server Management**

Server additional features enabled/disabled setup menus.

- **Security**

Change, set, or disable supervisor and user password. Configuration supervisor password allows you to restrict access to the system and BIOS Setup.

A supervisor password allows you to make changes in BIOS Setup.

A user password only allows you to view the BIOS settings but not to make changes.

- **Boot**

This setup page provides items for configuration of the boot sequence.

- **Save & Exit**

Save all the changes made in the BIOS Setup program to the CMOS and exit BIOS Setup. (Pressing <F10> can also carry out this task.)

Abandon all changes and the previous settings remain in effect. Pressing <Y> to the confirmation message will exit BIOS Setup. (Pressing <Esc> can also carry out this task.)

5-1 The Main Menu

Once you enter the BIOS Setup program, the Main Menu (as shown below) appears on the screen. Use arrow keys to move among the items and press <Enter> to accept or enter other sub-menu.

Main Menu Help

The on-screen description of a highlighted setup option is displayed on the bottom line of the Main Menu.

Submenu Help

While in a submenu, press <F1> to display a help screen (General Help) of function keys available for the menu. Press <Esc> to exit the help screen. Help for each item is in the Item Help block on the right side of the submenu.



- When the system is not stable as usual, select the **Restore Defaults** item to set your system to its defaults.
- The BIOS Setup menus described in this chapter are for reference only and may differ by BIOS version.

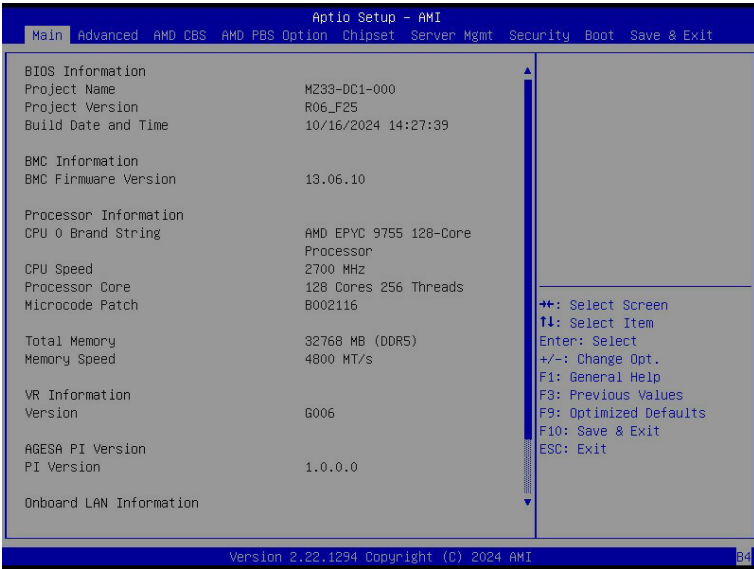

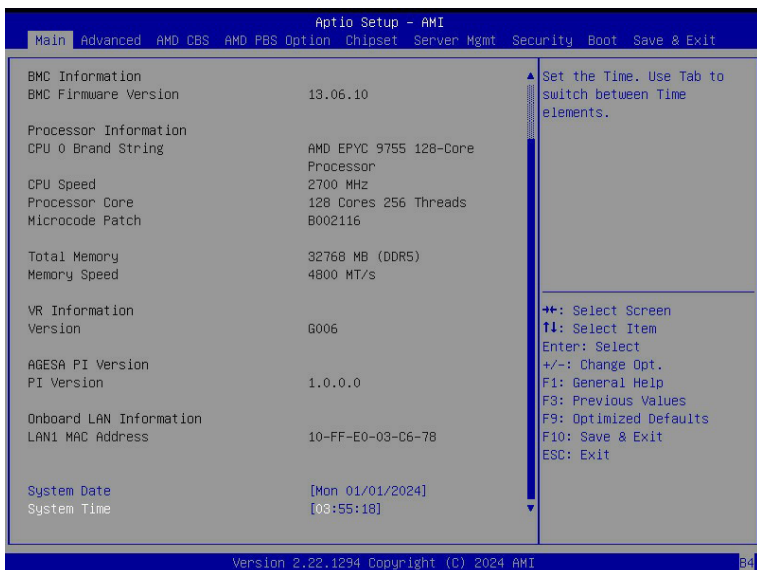

| Parameter | Description |
|---|---|
| BIOS Information | |
| Project Name | Displays the project name information. |
| Project Version | Displays version number of the BIOS setup utility. |
| Build Date and Time | Displays the date and time when the BIOS setup utility was created. |
| BMC Information ^(Note1) | |
| BMC Firmware Version ^(Note1) | Displays BMC firmware version information. |
| Processor Information | |
| CPU Brand String / CPU Speed / Processor Core / Microcode Patch | Displays the technical specifications for the installed processor(s). |
| Total Memory ^(Note2) | Displays the total memory size of the installed memory. |
| Memory Speed ^(Note2) | Displays the frequency information of the installed memory. |
| VR Information Version | Displays VR version information. |
| AGESA PI Version | |
| PI Version | Displays AGESA PI version information. |

(Note1) Functions available on selected models.

(Note2) This section will display capacity and frequency information of the memory that the customer has installed.

| Parameter | Description |
|-----------------------------------|---|
| Onboard LAN Information | |
| LAN MAC Address ^(Note) | Displays LAN MAC address information. |
| System Date | Sets the date following the weekday-month-day-year format. |
| System Time | Sets the system time following the hour-minute-second format. |

(Note) The number of LAN ports listed will depend on the motherboard / system model.

5-2 Advanced Menu

The Advanced Menu displays submenu options for configuring the function of various hardware components. Select a submenu item, then press <Enter> to access the related submenu screen.

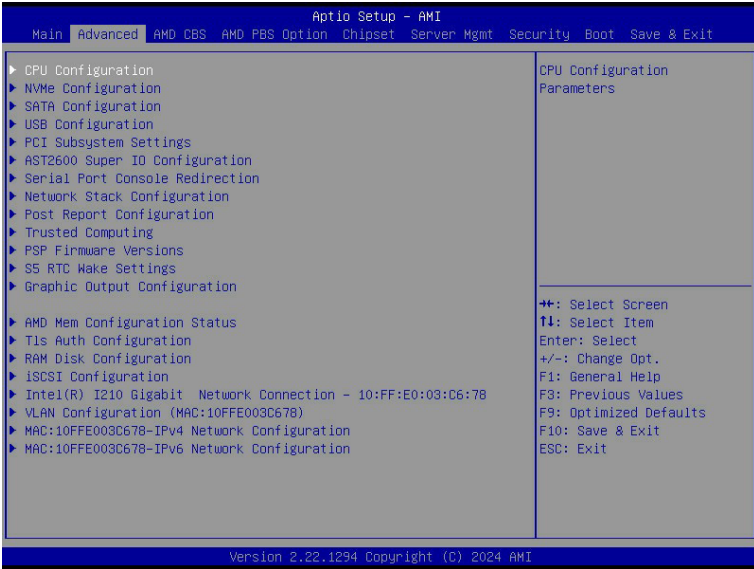

5-2-1 CPU Configuration

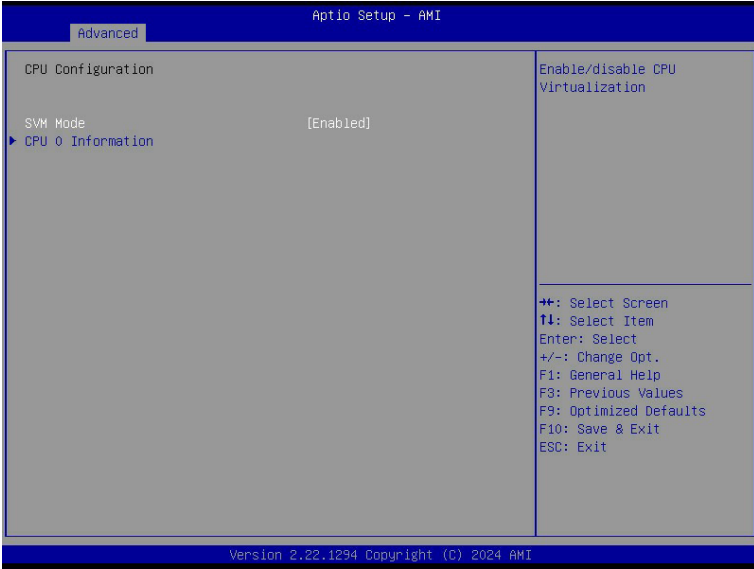

| Parameter | Description |
|-------------------|---|
| SVM Mode | Enable/Disable the CPU Virtualization. Options available: Disabled, Enabled. Default setting is Enabled . |
| CPU 0 Information | Press [Enter] to view the memory information related to CPU. |

5-2-2 NVMe Configuration

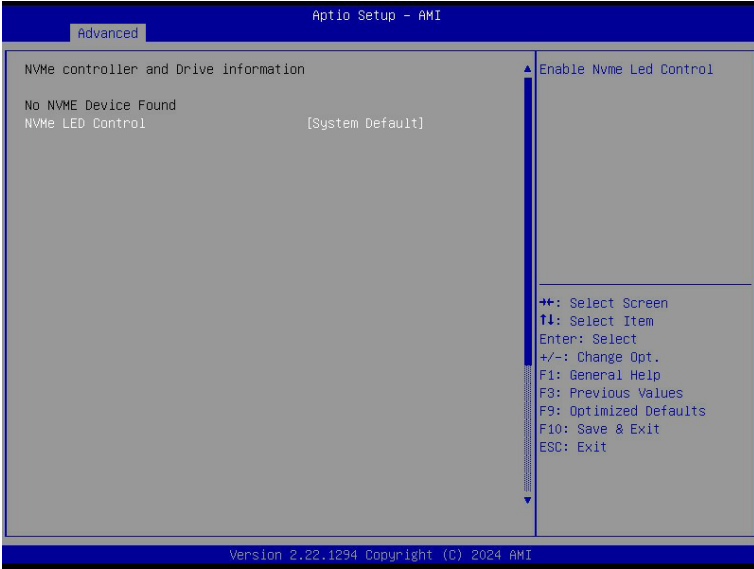

| Parameter | Description |
|--------------------|---|
| NVMe Configuration | Displays the NVMe devices connected to the system. |
| NVMe LED Control | Enable/Disable NVMe LED Control. Options available: System Default, Disabled, Enabled. Default setting is System Default . |

5-2-3 SATA Configuration

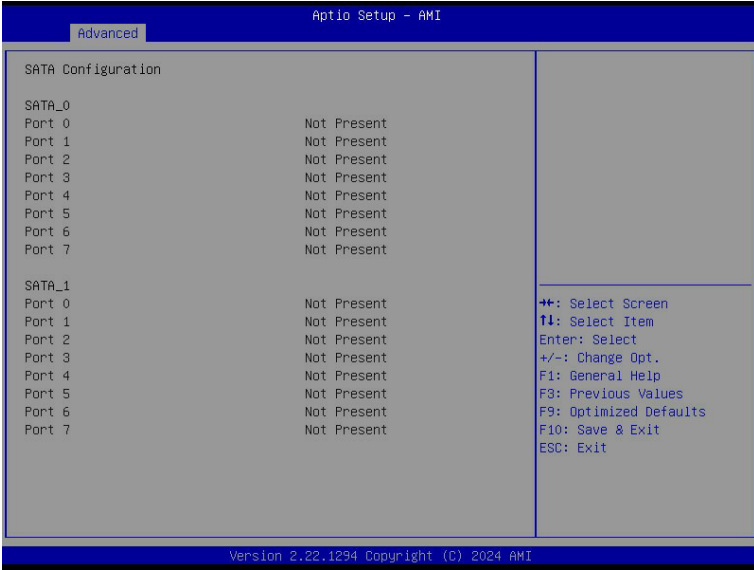

| Parameter | Description |
|--------------------|--|
| SATA Configuration | Displays the installed HDD devices information. System will automatically detect HDD type. |

5-2-4 USB Configuration



| Parameter | Description |
|---|---|
| USB Configuration | |
| USB Module Version | Displays the USB module version information. |
| USB Controllers | Displays the supported USB controllers. |
| USB Devices: | Displays the USB devices connected to the system. |
| Legacy USB Support | Enable/Disable the Legacy USB support function. AUTO option disables legacy support if no USB devices are connected. DISABLE option will keep USB devices available only for EFI applications. Options available: Enabled, Disabled, Auto. Default setting is Enabled . |
| XHCI Hand-off | Enable/Disable the XHCI Hand-off support. Options available: Enabled, Disabled. Default setting is Enabled . |
| USB Mass Storage Driver Support ^(Note) | Enable/Disable the USB Mass Storage Driver Support. Options available: Disabled, Enabled. Default setting is Enabled . |
| USB hardware delays and time-outs | |
| USB transfer time-out | Selects the time-out value for USB Control/Bulk/Interrupt transfers. Options available: 1 sec, 5 sec, 10 sec, 20 sec. Default setting is 20 sec . |

(Note) This item is present only if you attach USB devices.

| Parameter | Description |
|-----------------------|--|
| Device reset time-out | Selects the time-out value during a USB mass storage device reset. Options available: 10 sec, 20 sec, 30 sec, 40 sec. Default setting is 20 sec . |
| Device power-up delay | Maximum time the device will take before it properly reports itself to the Host Controller. "Auto" uses default value: for a Root port it is 100 ms, for a Hub port the delay is taken from Hub descriptor. Options available: Auto, Manual. Default setting is Auto . |

5-2-5 PCI Subsystem Settings

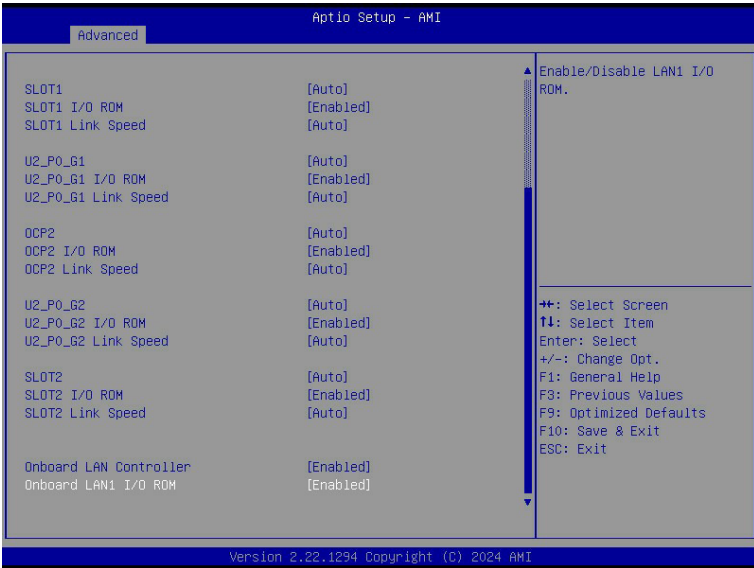
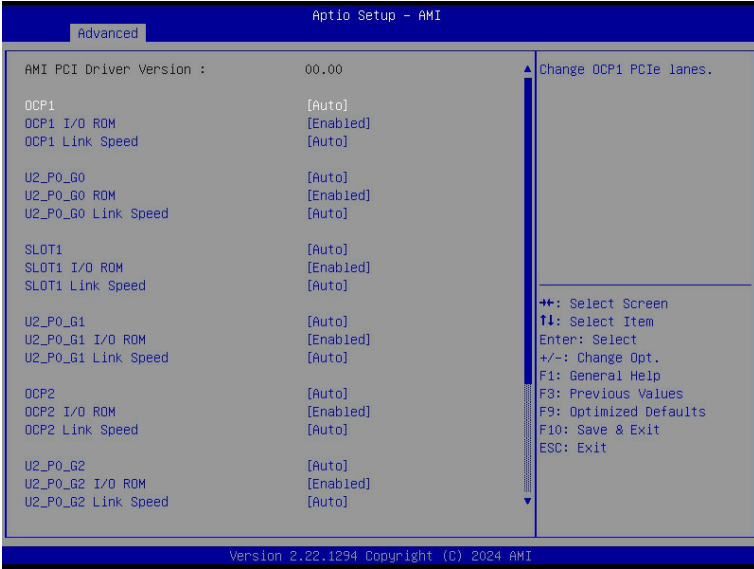

| Parameter | Description |
|--|---|
| PCI Bus Driver Version | Displays the PCI Bus Driver version information. |
| OCP# U2_P0_G0/1/2 SLOT# Lanes ^(Note1) | Change PCIe lanes. Options available: Disabled, Auto, x8, x16, x4x4, x8x8, x8x4x4, x4x4x8, x4x4x4x4. Default setting is Auto . |
| OCP# U2_P0_G0/1/2 SLOT# I/O ROM ^(Note1) | When enabled, this setting will initialize the device expansion ROM for the related devices. Options available: Disabled, Enabled. Default setting is Enabled . |
| OCP# U2_P0_G0/1/2 SLOT# Link Speed ^(Note1) | Configure PCIe slot max link speed. Options available: Auto, Gen5, Gen4, Gen3, Gen2, Gen1. Default setting is Auto . |
| Onboard LAN Controller ^(Note2) | Enable/Disable the onboard LAN devices. Options available: Disabled, Enabled. Default setting is Enabled . |
| Onboard LAN# I/O ROM ^(Note2) | Enable/Disable the onboard LAN devices, and initializes device expansion ROM. Options available: Disabled, Enabled. Default setting is Enabled . |

(Note1) This section is dependent on the available SLOT/MCIO/OCP connector.

(Note2) This section is dependent on the available LAN controller.

5-2-6 AST2600 Super IO Configuration

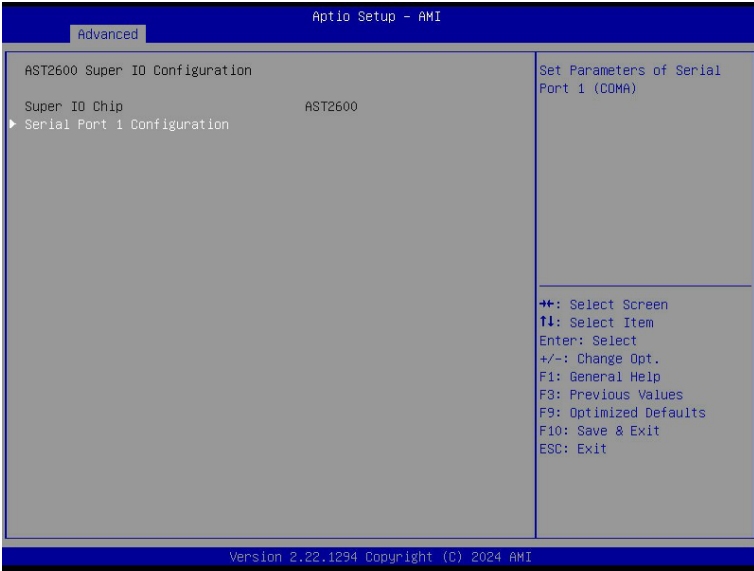

| Parameter | Description |
|--------------------------------|--|
| AST2600 Super IO Configuration | |
| Super IO Chip | Displays the super IO chip information |
| Serial Port 1 Configuration | Press [Enter] for configuration of advanced items. |

5-2-6-1 Serial Port 1 Configuration

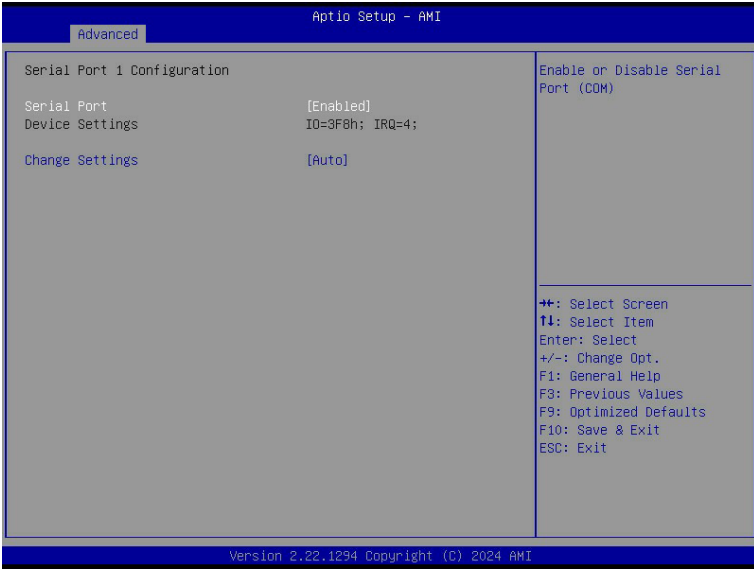

| Parameter | Description |
|-------------------------------|--|
| Serial Port 1 Configuration | |
| Serial Port ^(Note) | Enable/Disable the Serial Port (COM). When set to Enabled allows you to configure the Serial port 1 settings. When set to Disabled, displays no configuration for the serial port. Options available: Disabled, Enabled. Default setting is Enabled . |
| Devices Settings | Displays the Serial Port 1 device settings. |
| Change Settings | Select an optimal settings for Super IO Device. Options available for Serial Port 1: Auto IO=3F8h; IRQ=4; IO=3F8h; IRQ=3, 4, 5, 6, 7, 9, 10, 11, 12; IO=2F8h; IRQ=3, 4, 5, 6, 7, 9, 10, 11, 12; IO=3E8h; IRQ=3, 4, 5, 6, 7, 9, 10, 11, 12; IO=2E8h; IRQ=3, 4, 5, 6, 7, 9, 10, 11, 12; Default setting is Auto . |

(Note) Advanced items prompt when this item is defined.

5-2-7 Serial Port Console Redirection

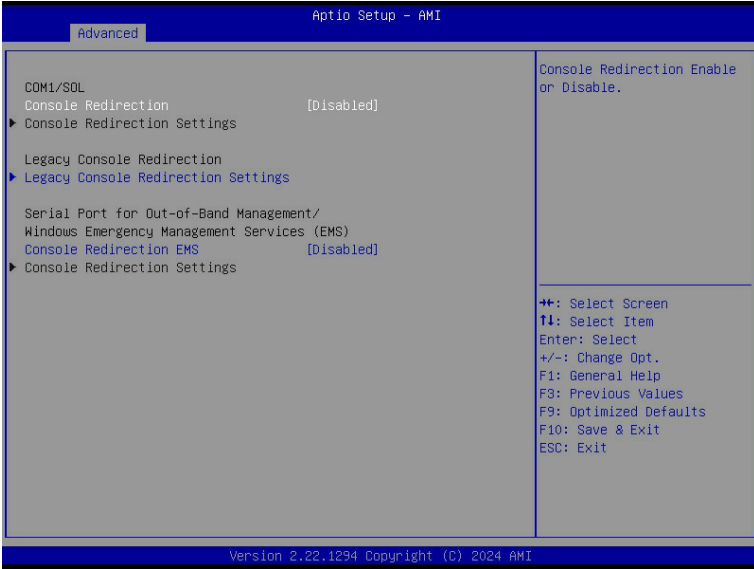

| Parameter | Description |
|--|--|
| COM1/Serial Over LAN Console Redirection ^(Note) | Select whether to enable console redirection for specified device. Console redirection enables the users to manage the system from a remote location. Options available: Enabled, Disabled. Default setting is Disabled . |
| COM1/Serial Over LAN Console Redirection Settings | Press [Enter] to configure advanced items. Please note that this item is configurable when COM1/Serial Over LAN Console Redirection is set to Enabled. <ul style="list-style-type: none"> ◆ Terminal Type <ul style="list-style-type: none"> – Selects a terminal type to be used for console redirection. – Options available: VT100, VT100Plus, ANSI, VT-UTF8. Default setting is VT100Plus. ◆ Bits per second <ul style="list-style-type: none"> – Selects the transfer rate for console redirection. – Options available: 9600, 19200, 38400, 57600, 115200. Default setting is 115200. ◆ Data Bits <ul style="list-style-type: none"> – Selects the number of data bits used for console redirection. – Options available: 7, 8. Default setting is 8. |

(Note) Advanced items prompt when this item is defined.

| Parameter | Description |
|---|---|
| COM1/Serial Over LAN Console Redirection Settings (continued) | <ul style="list-style-type: none"> ◆ Parity <ul style="list-style-type: none"> – A parity bit can be sent with the data bits to detect some transmission errors. – Even: parity bit is 0 if the num of 1's in the data bits is even. – Odd: parity bit is 0 if num of 1's in the data bits is odd. – Mark: parity bit is always 1. Space: Parity bit is always 0. – Mark and Space Parity do not allow for error detection. – Options available: None, Even, Odd, Mark, Space. Default setting is None. ◆ Stop Bits <ul style="list-style-type: none"> – Stop bits indicate the end of a serial data packet. (A start bit indicates the beginning). The standard setting is 1 stop bit. Communication with slow devices may require more than 1 stop bit. – Options available: 1, 2. Default setting is 1. ◆ Flow Control <ul style="list-style-type: none"> – Flow control can prevent data loss from buffer overflow. When sending data, if the receiving buffers are full, a 'stop' signal can be sent to stop the data flow. Once the buffers are empty, a 'start' signal can be sent to re-start the flow. Hardware flow control uses two wires to send start/stop signals. – Options available: None, Hardware RTS/CTS. Default setting is None. ◆ VT-UTF8 Combo Key Support <ul style="list-style-type: none"> – Enable/Disable the VT-UTF8 Combo Key Support. – Options available: Enabled, Disabled. Default setting is Enabled. ◆ Recorder Mode <ul style="list-style-type: none"> – When this mode enabled, only texts will be send. This is to capture Terminal data. – Options available: Enabled, Disabled. Default setting is Disabled. ◆ Resolution 100x31 <ul style="list-style-type: none"> – Enable/Disable extended terminal resolution. – Options available: Enabled, Disabled. Default setting is Enabled. ◆ Putty KeyPad <ul style="list-style-type: none"> – Selects Function Key and KeyPad on Putty. – Options available: VT100, LINUX, XTERMR6, SC0, ESCN, VT400. Default setting is VT100. |

| Parameter | Description |
|--|---|
| Legacy Console Redirection | |
| Legacy Console Redirection Settings | <p>Press [Enter] to configure advanced items.</p> <ul style="list-style-type: none"> ◆ Redirection COM Port <ul style="list-style-type: none"> – Selects a COM port for Legacy serial redirection. – Default setting is COM1/SOL. ◆ Resolution <ul style="list-style-type: none"> – Selects the number of rows and columns used in Console Redirection for legacy OS support. – Options available: 80x24, 80x25. Default setting is 80x24. ◆ Redirect After POST <ul style="list-style-type: none"> – When Bootloader is selected, then Legacy Console Redirection is disabled before booting to legacy OS. When Always Enable is selected, then Legacy Console Redirection is enabled for legacy OS. – Options available: Always Enable, BootLoader. Default setting is Always Enable. |
| Serial Port for Out-of-Band Management / Windows Emergency Management Services (EMS) Console Redirection ^(Note) | <p>EMS console redirection allows the user to configure Console Redirection Settings to support Out-of-Band Serial Port management.</p> <p>Options available: Disabled, Enabled. Default setting is Disabled.</p> |
| Serial Port for Out-of-Band EMS Console Redirection Settings | <p>Press [Enter] to configure advanced items.</p> <p>Please note that this item is configurable when Serial Port for Out-of-Band Management EMS Console Redirection is set to Enabled.</p> <ul style="list-style-type: none"> ◆ Out-of-Band Mgmt Port <ul style="list-style-type: none"> – Microsoft Windows Emergency Management Service (EMS) allows for remote management of a Windows Server OS through a serial port. – Default setting is COM1/SOL. ◆ Terminal Type <ul style="list-style-type: none"> – Selects a terminal type to be used for console redirection. – Options available: VT100, VT100Plus, ANSI, VT-UTF8. Default setting is ANSI. ◆ Bits per second <ul style="list-style-type: none"> – Selects the transfer rate for console redirection. – Options available: 9600, 19200, 57600, 115200. Default setting is 115200. |

(Note) Advanced items prompt when this item is defined.

| Parameter | Description |
|---|---|
| Serial Port for Out-of-Band EMS Console Redirection Settings(continued) | <ul style="list-style-type: none">◆ Flow Control<ul style="list-style-type: none">– Flow control can prevent data loss from buffer overflow. When sending data, if the receiving buffers are full, a 'stop' signal can be sent to stop the data flow. Once the buffers are empty, a 'start' signal can be sent to re-start the flow. Hardware flow control uses two wires to send start/stop signals.– Options available: None, Hardware RTS/CTS, Software Xon/Xoff. Default setting is None. |

5-2-8 Network Stack Configuration

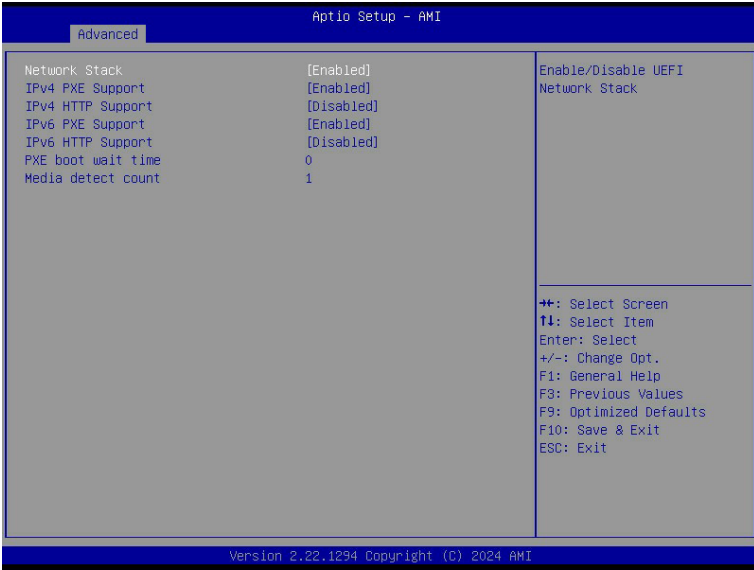

| Parameter | Description |
|--------------------------------------|--|
| Network Stack | Enable/Disable the UEFI network stack. Options available: Enabled, Disabled. Default setting is Enabled . |
| Ipv4 PXE Support ^(Note) | Enable/Disable the Ipv4 PXE feature. Options available: Enabled, Disabled. Default setting is Enabled . |
| Ipv4 HTTP Support ^(Note) | Enable/Disable the Ipv4 HTTP feature. Options available: Enabled, Disabled. Default setting is Disabled . |
| Ipv6 PXE Support ^(Note) | Enable/Disable the Ipv6 PXE feature. Options available: Enabled, Disabled. Default setting is Enabled . |
| Ipv6 HTTP Support ^(Note) | Enable/Disable the Ipv6 HTTP feature. Options available: Enabled, Disabled. Default setting is Disabled . |
| PXE boot wait time ^(Note) | Wait time in seconds to press ESC key to abort the PXE boot. Press the <+> / <-> keys to increase or decrease the desired values. |
| Media detect count ^(Note) | Number of times the presence of media will be checked. Press the <+> / <-> keys to increase or decrease the desired values. |

(Note) This item appears when **Network Stack** is set to **Enabled**.

5-2-9 Post Report Configuration

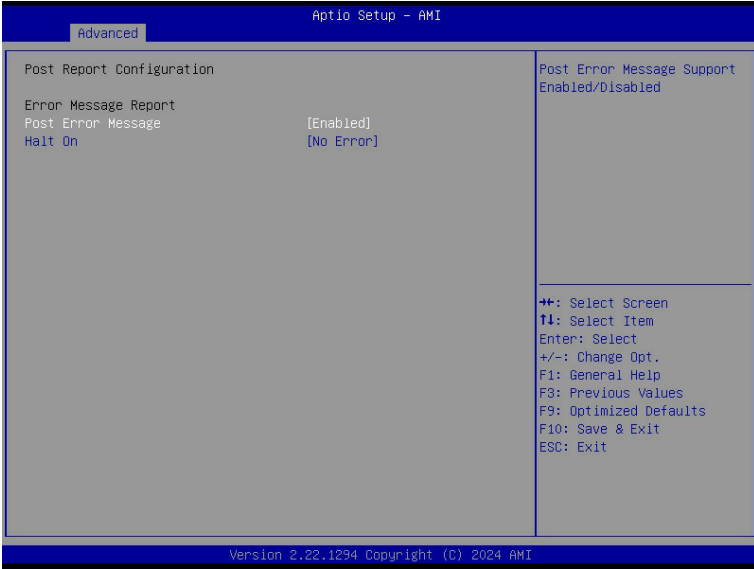

| Parameter | Description |
|---------------------------|---|
| Post Report Configuration | |
| Error Message Report | |
| Post Error Message | Enable/Disable the POST Error Message support. Options available: Enabled, Disabled. Default setting is Enabled . |
| Halt On | Options available: No Error, All Error. Default setting is No Error . |

5-2-10 Trusted Computing

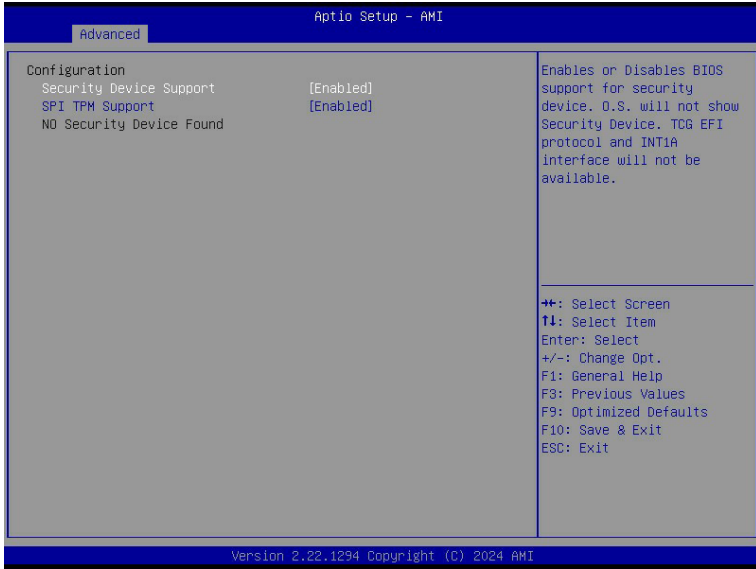

| Parameter | Description |
|-------------------------|---|
| Configuration | |
| Security Device Support | <p>Enable/Disable BIOS support for security device. OS will not show security device. TCG EFI protocol and INT1A interface will not be available.</p> <p>Options available: Disabled, Enabled. Default setting is Enabled.</p> |
| SPI TPM Support | <p>Select Enable to activate TPM support feature.</p> <p>Options available: Disabled, Enabled. Default setting is Enabled.</p> |

5-2-11 PSP Firmware Versions

The PSP Firmware Versions page displays the basic PSP firmware version information. Items on this window are non-configurable.

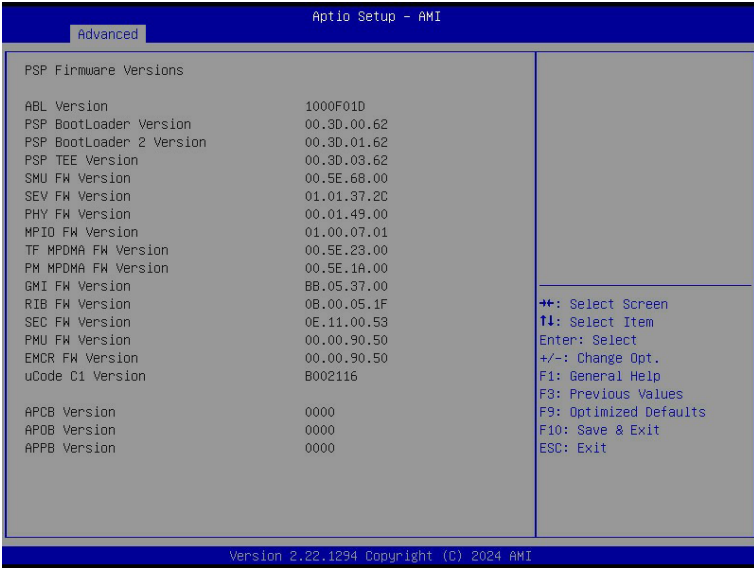

5-2-12 S5 RTC Wake Settings

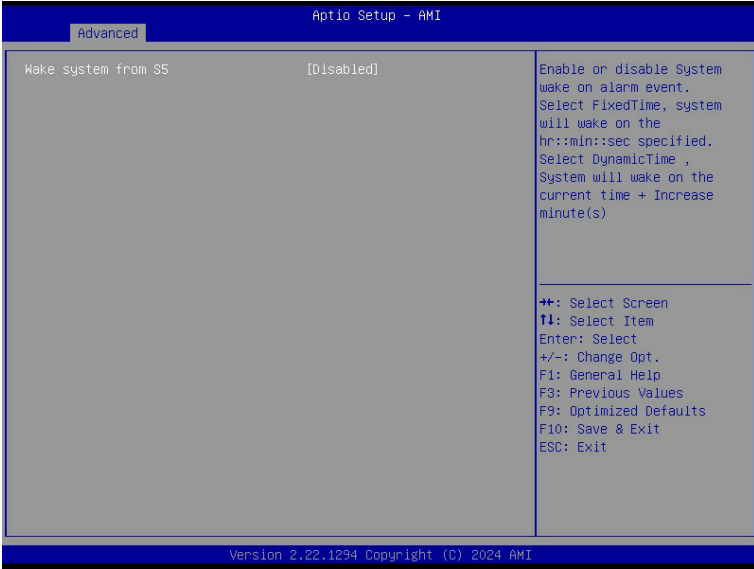

| Parameter | Description |
|---------------------|---|
| Wake System from S5 | Enable/Disable system wake on alarm event. Options available: Disabled, Fixed Time, Dynamic Time. When Fixed Time is selected, system will wake on the hr:min::sec specified. Default setting is Disabled . |

5-2-13 Graphic Output Configuration

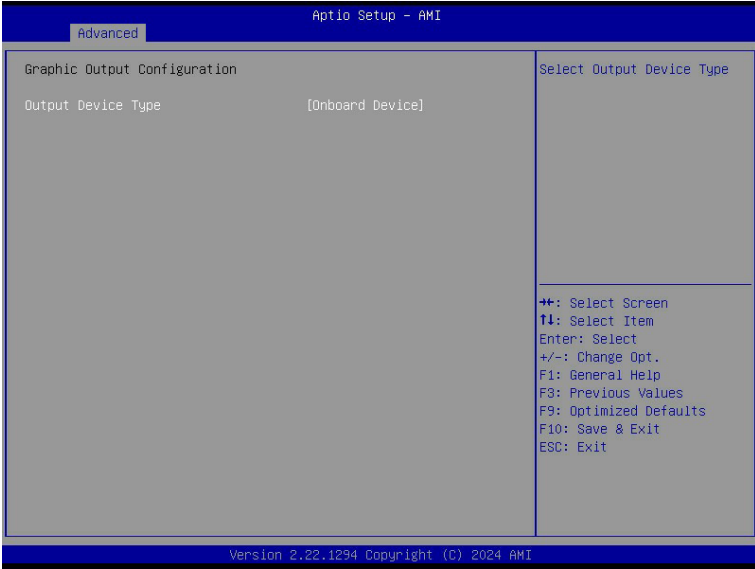

| Parameter | Description |
|--------------------|---|
| Output Device Type | Selects output device type. Options available: First loaded Device, Onboard Device, External Device, Specific Device. Default setting is Onboard Device . |

5-2-14 AMD Mem Configuration Status

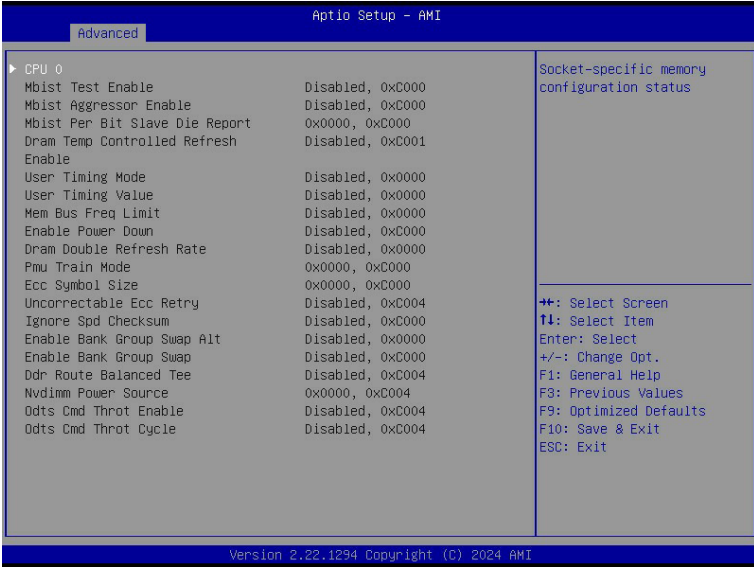

| Parameter | Description |
|-----------|---|
| CPU 0 | Press [Enter] to view the memory configuration status related to CPU. |

5-2-15 Tls Auth Configuration

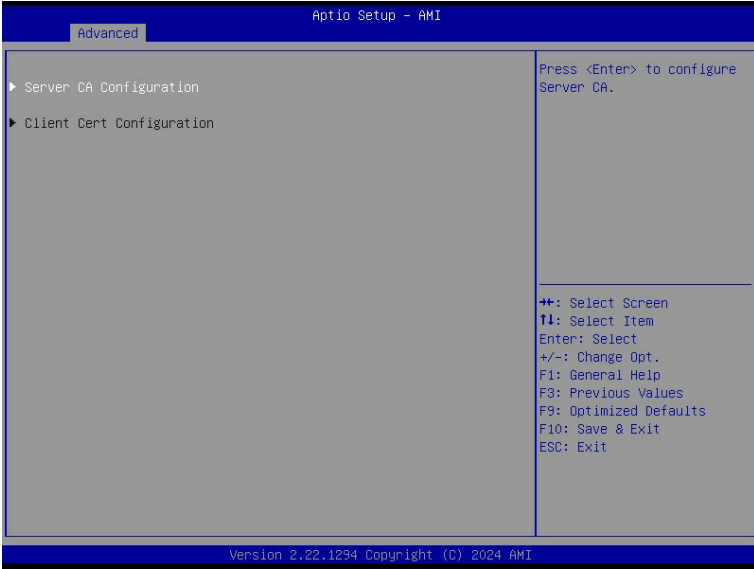

| Parameter | Description |
|---------------------------|---|
| Server CA Configuration | <p>Press [Enter] for configuration of advanced items.</p> <ul style="list-style-type: none"> ◆ Enroll Cert <ul style="list-style-type: none"> – Press [Enter] to enroll a certificate <ul style="list-style-type: none"> • Enroll Cert Using File • Cert GUID <p>Input digit character in 1111111-2222-3333-4444-1234567890ab format.</p> <ul style="list-style-type: none"> – Commit Changes and Exit – Discard Changes and Exit <ul style="list-style-type: none"> ◆ Delete Cert |
| Client Cert Configuration | Press [Enter] for configuration of advanced items. |

5-2-16 RAM Disk Configuration

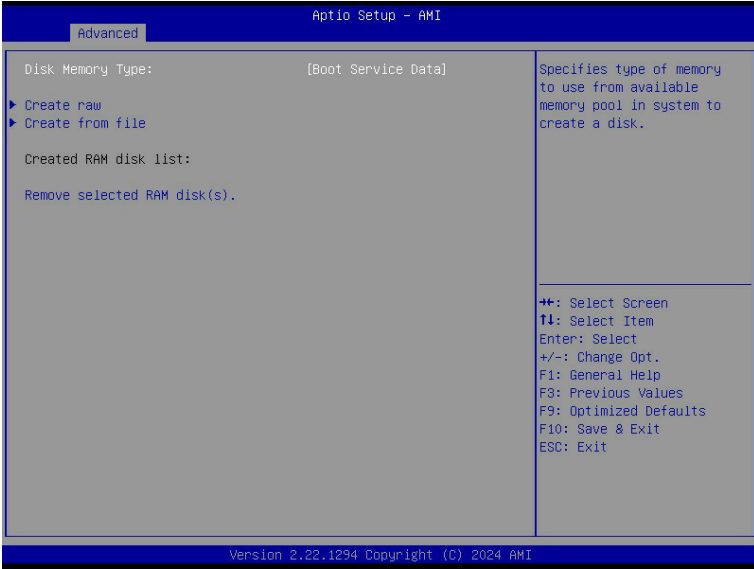

| Parameter | Description |
|-----------------------------|--|
| Disk Memory Type | Specifies the type of memory to use from available memory pool in system to create a disk. Options available: Boot Service Data, Reserved. Default setting is Boot Service Data . |
| Create Raw | Creates a raw RAM disk. <ul style="list-style-type: none"> ◆ Size (Hex) <ul style="list-style-type: none"> – Input a valid RAM disk size that should be multiple of the RAM disk block size. ◆ Create & Exit ◆ Discard & Exit |
| Create from file | Creates a RAM disk from a given file. |
| Created RAM disk list | |
| Remove selected RAM disk(s) | Selects the RAM disk(s) to remove. |

5-2-17 iSCSI Configuration

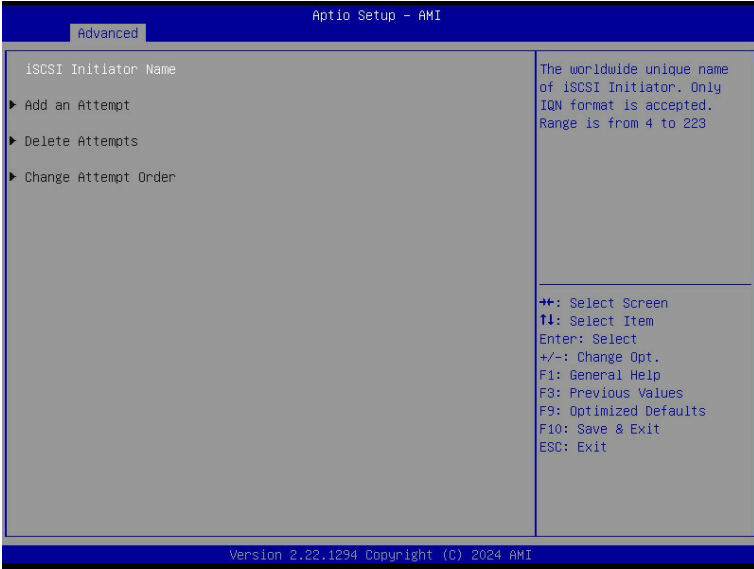

| Parameter | Description |
|----------------------|---|
| iSCSI Initiator Name | Press [Enter] and name iSCSI Initiator. Only IQN format is accepted. Range: from 4 to 223 |
| Add an Attempt | Press [Enter] to configure advanced items. |
| Delete Attempts | Press [Enter] to configure advanced items. |
| Change Attempt Order | Press [Enter] to configure advanced items. |

5-2-18 Intel(R) I210 Gigabit Network Connection

| Aptio Setup - AMI | | |
|--|--|---|
| Advanced | | |
| <p>▶ NIC Configuration</p> <p>Blink LEDs 0</p> <p>UEFI Driver Intel(R) PRO/1000 8.5.21 PCI-E</p> <p>Adapter PBA 211018-008</p> <p>Device Name Intel(R) I210 Gigabit Network Connection</p> <p>Chip Type Intel i210</p> <p>PCI Device ID 1533</p> <p>PCI Address A3:00:00</p> <p>Link Status [Disconnected]</p> <p>MAC Address 10:FF:E0:03:D6:78</p> <p>Virtual MAC Address 00:00:00:00:00:00</p> | | <p>Click to configure the network device port.</p> <hr/> <p> ++: Select Screen ↑↓: Select Item Enter: Select +/-: Change Opt. F1: General Help F8: Previous Values F9: Optimized Defaults F10: Save & Exit ESC: Exit </p> |
| Version 2.22.1294 Copyright (C) 2024 AMI | | |

| Aptio Setup - AMI | | |
|--|--|---|
| Advanced | | |
| <p>Link Speed [Auto Negotiated]</p> <p>Wake On LAN [Enabled]</p> | | <p>Specifies the port speed used for the selected boot protocol.</p> <hr/> <p> ++: Select Screen ↑↓: Select Item Enter: Select +/-: Change Opt. F1: General Help F8: Previous Values F9: Optimized Defaults F10: Save & Exit ESC: Exit </p> |
| Version 2.22.1294 Copyright (C) 2024 AMI | | |

| Parameter | Description |
|---------------------|---|
| NIC Configuration | <p>Press [Enter] to configure advanced items.</p> <ul style="list-style-type: none"> ◆ Link Speed <ul style="list-style-type: none"> – Allows for automatic link speed adjustment. – Options available: Auto Negotiated, 10 Mbps Half, 10 Mbps Full, 100 Mbps Half, 100 Mbps Full. Default setting is Auto Negotiated. ◆ Wake On LAN <ul style="list-style-type: none"> – Enables power on of the system via LAN. Note that configuring Wake on LAN in the operating system does not change the value of this setting, but does override the behavior of Wake on LAN in OS controlled power states. – Options available: Disabled, Enabled. Default setting is Enabled. |
| Blink LEDs | <p>Identifies the physical network port by blinking the associated LED. Press the numeric keys to adjust desired values.</p> |
| UEFI Driver | Displays the technical specifications for the Network Interface Controller. |
| Adapter PBA | Displays the technical specifications for the Network Interface Controller. |
| Device Name | Displays the technical specifications for the Network Interface Controller. |
| Chip Type | Displays the technical specifications for the Network Interface Controller. |
| PCI Device ID | Displays the technical specifications for the Network Interface Controller. |
| PCI Address | Displays the technical specifications for the Network Interface Controller. |
| Link Status | Displays the technical specifications for the Network Interface Controller. |
| MAC Address | Displays the technical specifications for the Network Interface Controller. |
| Virtual MAC Address | Displays the technical specifications for the Network Interface Controller. |

5-2-19 VLAN Configuration

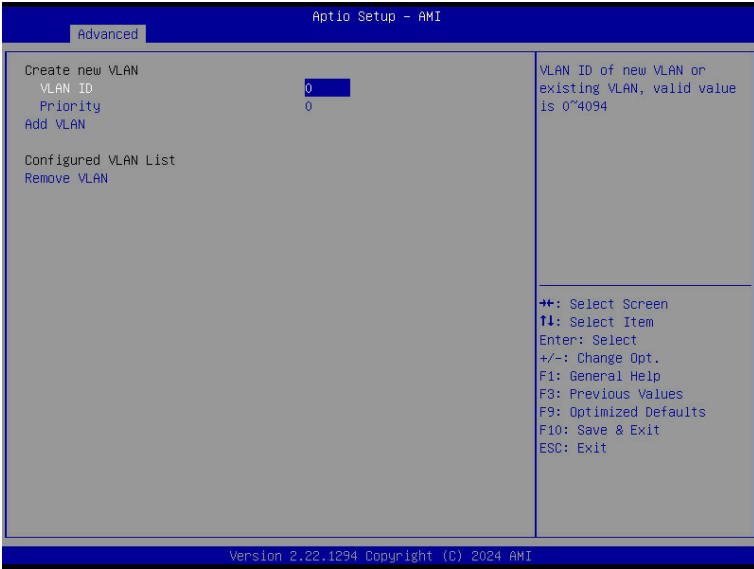

| Parameter | Description |
|--------------------------|---|
| Enter Configuration Menu | <p>Press [Enter] to configure advanced items.</p> <ul style="list-style-type: none"> ◆ Create new VLAN ◆ VLAN ID <ul style="list-style-type: none"> – Sets VLAN ID for a new VLAN or an existing VLAN. – Press the <+> / <-> keys to increase or decrease the desired values. – The valid range is from 0 to 4094. ◆ Priority <ul style="list-style-type: none"> – Sets 802.1Q Priority for a new VLAN or an existing VLAN. – Press the <+> / <-> keys to increase or decrease the desired values. – The valid range is from 0 to 7. ◆ Add VLAN <ul style="list-style-type: none"> – Press [Enter] to create a new VLAN or update an existing VLAN. ◆ Configured VLAN List ◆ Remove VLAN <ul style="list-style-type: none"> – Press [Enter] to remove an existing VLAN. |

5-2-20 MAC IPv4 Network Configuration

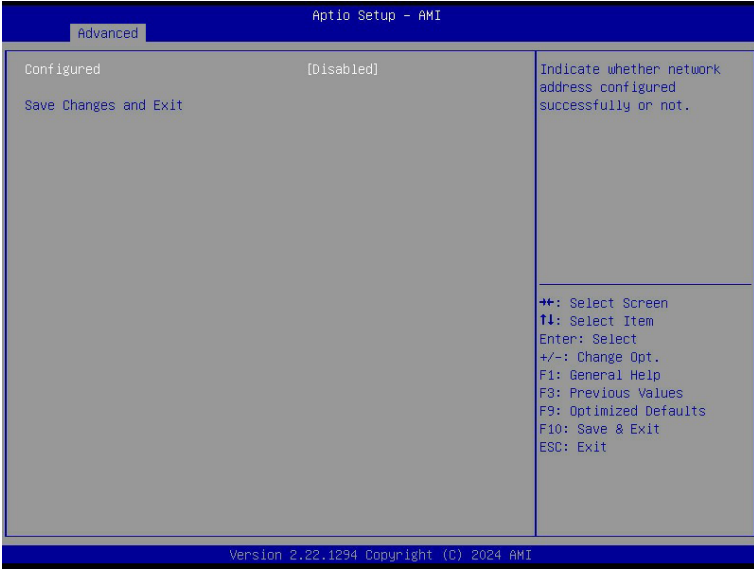

| Parameter | Description |
|-------------------------------------|---|
| Configured | Indicates whether network address is configured successfully or not. Options available: Enabled, Disabled. Default setting is Disabled . |
| Enable DHCP ^(Note) | Options available: Enabled, Disabled. Default setting is Disabled . |
| Local IP Address ^(Note) | Press [Enter] to configure local IP address. |
| Local NetMask ^(Note) | Press [Enter] to configure local NetMask. |
| Local Gateway ^(Note) | Press [Enter] to configure local Gateway |
| Local DNS Servers ^(Note) | Press [Enter] to configure local DNS servers |
| Save Changes and Exit | Press [Enter] to save all configurations. |

(Note) This item appears when **Configured** is set to **Enabled**.

5-2-21 MAC IPv6 Network Configuration

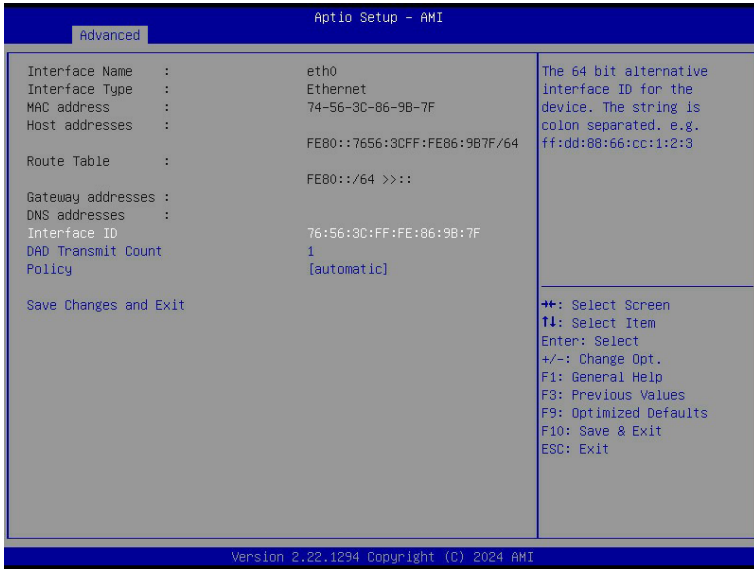

| Parameter | Description |
|--------------------------|---|
| Enter Configuration Menu | <p>Press [Enter] to configure advanced items.</p> <ul style="list-style-type: none"> ◆ Displays the MAC Address information. ◆ Interface ID <ul style="list-style-type: none"> – The 64 bit alternative interface ID for the device. The string is colon separated. e.g. ff:dd:88:66:cc:1:2:3. ◆ DAD Transmit Count <ul style="list-style-type: none"> – The number of consecutive Neighbor solicitation messages sent while performing Duplicate Address Detection on a tentative address. A value of zero indicates that Duplicate Address Detection is not performed. ◆ Policy <ul style="list-style-type: none"> – Options available: automatic, manual. Default setting is automatic. ◆ Save Changes and Exit <ul style="list-style-type: none"> – Press [Enter] to save all configurations. |

5-3 AMD CBS Menu

AMD CBS menu displays submenu options for configuring the CPU-related information that the BIOS automatically sets. Select a submenu item, then press [Enter] to access the related submenu screen.

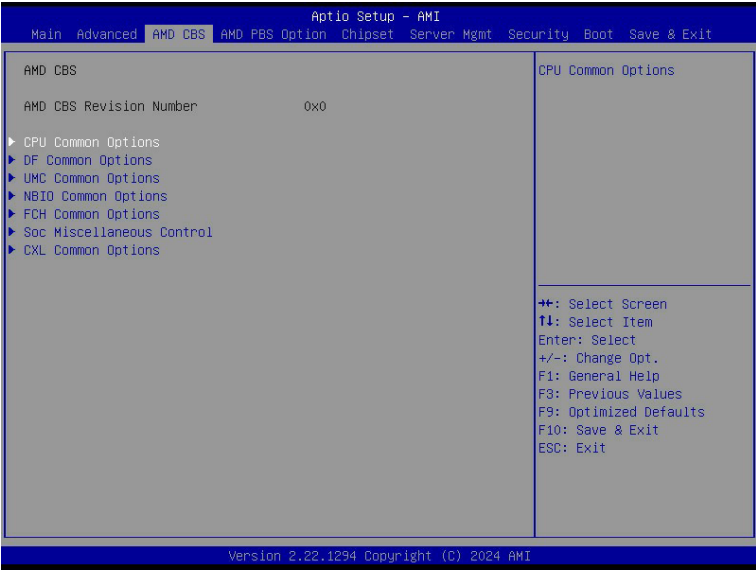

5-3-1 CPU Common Options

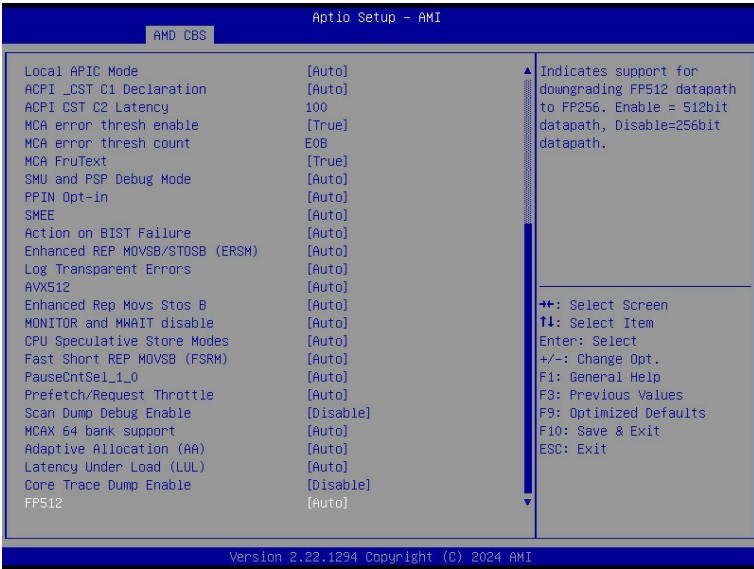
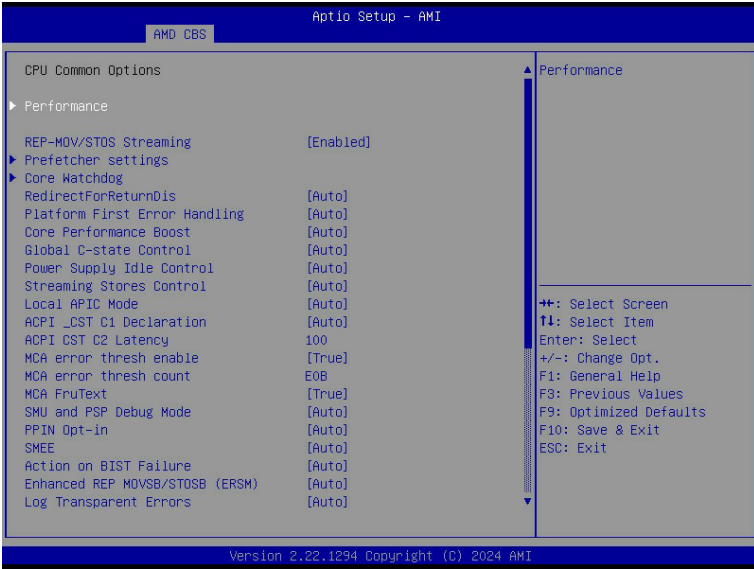

| Parameter | Description |
|-------------------------------|---|
| CPU Common Options | |
| Performance | Press [Enter] for configuration of advanced items. |
| REP-MOV/STOS Streaming | Allow REP-MOV/STOS to use non-caching streaming stores for large sizes. Options available: Disabled, Enabled. Default setting is Enabled . |
| Prefetcher settings | Press [Enter] for configuration of advanced items. |
| Core Watchdog | Press [Enter] for configuration of advanced items. |
| RedirectForReturnDis | From a workaround for GCC/C000005 issue for XV Core on CZ A0, setting MSRC001_1029 Decode Configuration (DE_CFG) bit 14 [DecfgNoRdrctForReturns] to 1. Options available: Auto, 1, 0. Default setting is Auto . |
| Platform First Error Handling | Enable/Disable PFEH, cloak individual banks, and mask deferred error interrupts from each bank. Options available: Enabled, Disabled, Auto. Default setting is Auto . |
| Core Performance Boost | Enable/Disable the Core Performance Boost function. Options available: Disabled, Auto. Default setting is Auto . |
| Global C-state Control | Controls the IO based C-state generation and DF C-states. Options available: Disabled, Enabled, Auto. Default setting is Auto . |
| Power Supply Idle Control | Configures the Power Supply Idle Control. Options available: Low Current Idle, Typical Current Idle, Auto. Default setting is Auto . |
| Streaming Stores Control | Enable/Disable the Streaming Stores functionality. Options available: Disabled, Enabled, Auto. Default setting is Auto . |
| Local APIC Mode | Sets the Local APIC Mode. Options available: Compatibility, xAPIC, x2APIC, Auto. Default setting is Auto . |
| ACPI_CST C1 Declaration | Determines whether or not to declare the C1 state to the OS.. Options available: Disabled, Enabled, Auto. Default setting is Auto . |
| ACPI CST C2 Latency | Enter in microseconds (decimal value). |
| MCA error thresh enable | Enable MCA error thresholding. Options available: False, True, Auto. Default setting is True . |
| MCA error thresh count | Effective error threshold count = 0xFFFF(4095) - <this value> (e.g. the default value of 0xFF5(4085) results in a threshold of 0xA (10)). |
| MCA FruText | Enable MCA FruText. Options available: False, True. Default setting is True . |
| SMU and PSP Debug Mode | When this option is enabled, specific uncorrected errors detected by the PSP FW or SMU FW will hand and not reset the system. Options available: Disabled, Enabled, Auto. Default setting is Auto . |
| PPIN Opt-in | Enable/Disable the PPIN feature. Options available: Disabled, Enabled, Auto. Default setting is Auto . |
| SMEE | Controls the Secure Memory Encryption Enable (SMEE) function. Options available: Disable, Enable, Auto. Default setting is Auto . |
| Action on BIST Failure | Action to take when a CCD BIST failure is detected. Options available: Do nothing, Down-CCD, Auto. Default setting is Auto . |

| Parameter | Description |
|-------------------------------------|---|
| Enhanced REP MOVSB/ STOSB (ERSM) | Options available: Disabled, Enabled, Auto. Default setting is Auto . |
| Log Transparent Errors | Enable/Disable the log Transparent errors function. Options available: Auto, Disabled, Enabled. Default setting is Auto . |
| AVX512 | Enable/Disable AVX512. Options available: Disabled, Enabled, Auto. Default setting is Auto . |
| Enhanced REP Movs Stos B | Options available: Disabled, Enabled, Auto. Default setting is Auto . |
| MONITOR and MWAIT disable | The MONITOR, MWAIT, MONITORX and MWAITX opcodes become invalid when enabled. Options available: Enabled, Disabled, Auto. Default setting is Auto |
| CPU Speculative Store Modes | Select the CPU speculative store modes. Options available: Balanced, More Speculative, Less Speculative, Auto. Default setting is Auto . |
| Fast Short REP MOVSB (FSRM) | Options available: Disabled, Enabled, Auto. Default setting is Auto . |
| PauseCntSel_1_0 | Options available: Disabled, Enabled, Auto. Default setting is Auto . |
| Prefetch/Request Throttle | Enables XI logic which calculates average latency, updates throttle level, and sends throttle level messages to L2. Options available: Disable, Enable, Auto. Default setting is Auto . |
| Scan Dump Debug Enable | Options available: Disable, Enable. Default setting is Disable . |
| MCAX 64 bank support | Options available: Disabled, Enabled, Auto. Default setting is Auto . |
| Adaptive Allocation (AA) | Options available: Disabled, Enabled, Auto. Default setting is Auto . |
| Latency Under Load (LUL) | Options available: Disabled, Enabled, Auto. Default setting is Auto . |
| Core Trace Dump Enable | Options available: Disable, Enable. Default setting is Disable . |
| FP512 | Options available: Disabled, Enabled, Auto. Default setting is Auto . |

5-3-1-1 Performance

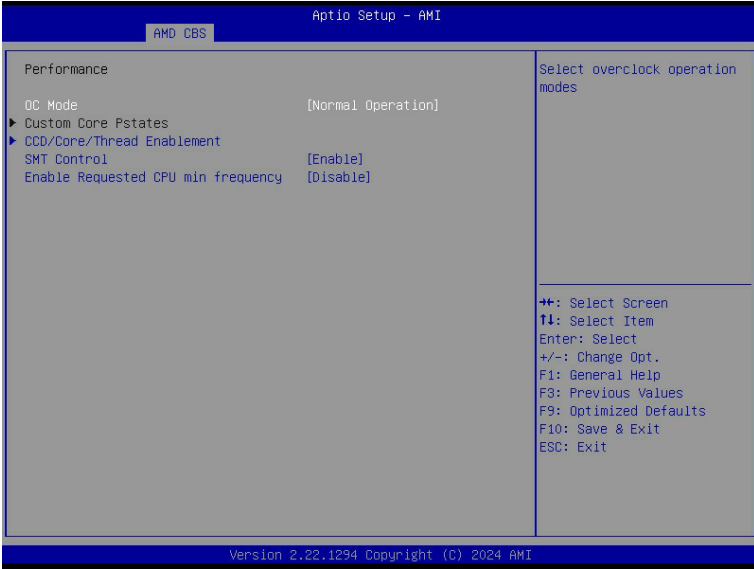

| Parameter | Description |
|------------------------------------|--|
| Performance | |
| OC Mode ^(Notes) | Options available: Normal Operation, Customized. Default setting is Normal Operation . |
| Custom Core Pstates | Allows you to accept or decline enabling Custom Core Pstates. When accepted, you can disable or customize core pstates. |
| CCD/Core/Thread Enablement | Allows you to accept or decline enabling CCDs, processor cores and threads. When accepted, you can control the number of CCDs to be used, and the number of cores to be used. <ul style="list-style-type: none"> ◆ CCD Control <ul style="list-style-type: none"> – Options available: Auto, 2 CCDs, 4 CCDs, 6 CCDs, 8 CCDs, 10 CCDs, 12 CCDs, 14 CCDs. Default setting is Auto. ◆ Core Control <ul style="list-style-type: none"> – Options available: Auto, ONE(1+0), TWO(2+0), THREE(3+0) FOUR(4+0), FIVE(5+0), SIX(6+0), SEVEN(7+0). – Default setting is Auto. |
| SMT Control | Can be used to disable symmetric multithreading. To re-enable SMT, a POWER CYCLE is needed after select the 'Enable' option. Select 'Auto' base on BIOS PCD. (PcdAmdSmtMode) default setting. Options available: Disable, Enable, Auto. Default setting is Enable . |
| Enable Requested CPU min frequency | Options available: Disable, Enable, Auto. Default setting is Disable . |

(Note) Advanced items are configurable when this item is defined.

5-3-1-2 Prefetcher Settings

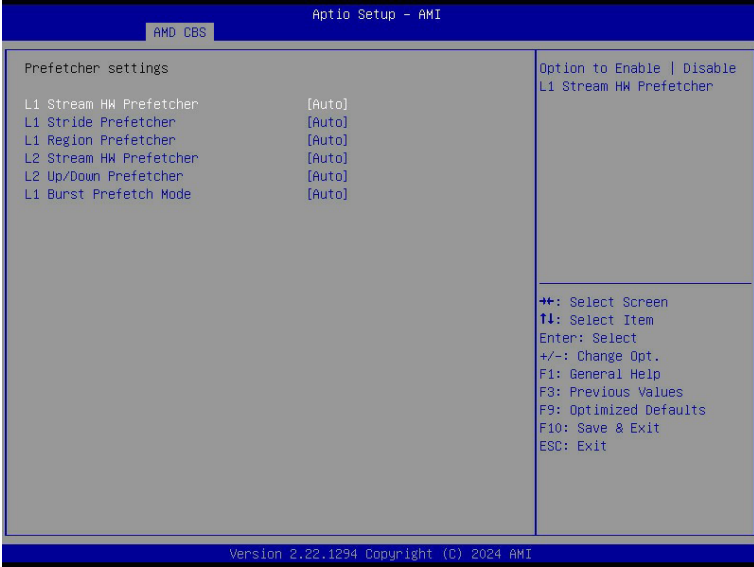

| Parameter | Description |
|-------------------------|---|
| Prefetcher settings | |
| L1 Stream HW Prefetcher | Enable/Disable L1 Stream HW Prefetcher. Options available: Disable, Enable, Auto. Default setting is Auto . |
| L1 Stride Prefetcher | Use memory access history of individual instructions to fetch additional lines when each access is a constant distance from the previous. Enable/Disable L1 Stride Prefetcher. Options available: Disable, Enable, Auto. Default setting is Auto . |
| L1 Region Prefetcher | Use memory access history to fetch additional lines when the data access for a given instruction tends to be followed by other data accesses. Enable/Disable L1 Region Prefetcher. Options available: Disable, Enable, Auto. Default setting is Auto . |
| L2 Stream HW Prefetcher | Enable/Disable L2 Stream HW Prefetcher. Options available: Disable, Enable, Auto. Default setting is Auto . |
| L2 Up/Down Prefetcher | Use memory access history to determine whether to fetch the next or previous line for all memory accesses. Enable/Disable L2 Up/Down Prefetcher. Options available: Disable, Enable, Auto. Default setting is Auto . |
| L1 Burst Prefetch Mode | Enable/Disable L1 Burst Prefetch Mode. Options available: Disable, Enable, Auto. Default setting is Auto . |

5-3-1-3 Core Watchdog

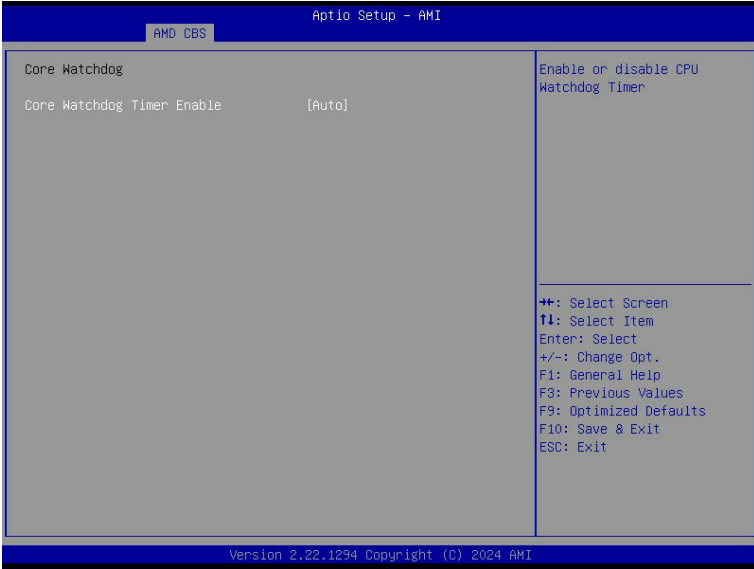

| Parameter | Description |
|--|--|
| Core Watchdog | |
| Core Watchdog Timer Enable ^(Note) | Enable/Disable CPU Watchdog Timer. Options available: Disabled, Enabled, Auto. Default setting is Auto . Select the CPU Watchdog Timer interval. |
| Core Watchdog Timer Interval | Options available: 2.681s, 1.340s, 669.41ms, 334.05ms, 166.37ms, 82.53ms, 40.61ms, 20.970ms, 10.484ms, 5.241ms, 2.620ms, 1.309ms, 654.08us, 326.4us, 162.56us, 80.64us, 39.68us, Auto. Default setting is Auto . |
| Core Watchdog Timer Severity | Options available: No Error, Transparent, Corrected, Deferred, Uncorrected, Fatal, Auto. Default setting is Auto . |

(Note) Advanced items prompt when this item is defined.

5-3-2 DF Common Options

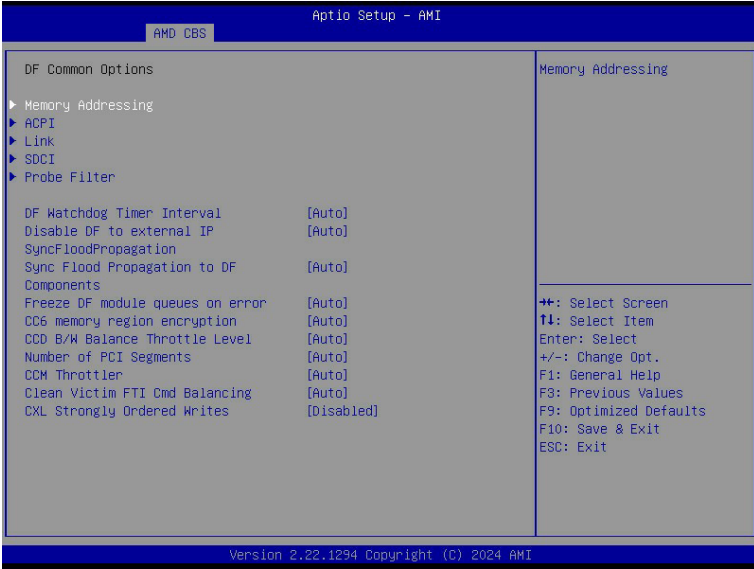

| Parameter | Description |
|--|---|
| DF Common Options | |
| Memory Addressing | Press [Enter] for configuration of advanced items. |
| ACPI | Press [Enter] for configuration of advanced items. |
| Link | Press [Enter] for configuration of advanced items. |
| SDCI | Press [Enter] for configuration of advanced items. |
| Probe Filter | Press [Enter] for configuration of advanced items. |
| DF Watchdog Timer Interval | Configures the Data Fabric watchdog timer interval. Options available: Auto, 41ms, 166ms, 334ms, 669ms, 1.34 seconds, 2.68 seconds, 5.36 seconds. Default setting is Auto . |
| Disable DF to external IP sync flood propagation | Enable/Disable SyncFlood to UMC & downstream slaves. Options available: Sync flood disabled, Sync flood enabled, Auto. Default setting is Auto . |
| Sync flood propagation to DF Components | Enable/Disable DF Sync Flood propagation. Options available: Sync flood disabled, Sync flood enabled, Auto. Default setting is Auto . |
| Freeze DF module queues on error | Options available: Disabled, Enabled, Auto. Default setting is Auto . |
| CC6 memory region encryption | Controls whether or not the CC6 save/restor memory is encrypted. Options available: Disabled, Enabled, Auto. Default setting is Auto . |
| CCD B/W Balance Throttle Level | Options available: Auto, Level 0, Level 1, Level 2, Level 3, Level 4. Default setting is Auto . |

| Parameter | Description |
|-----------------------------------|--|
| Number of PCI Segments | Options available: Auto, 1 Segment, 2 Segments, 4 Segment. Default setting is Auto . |
| CCM Throttler | Options available: Disabled, Enabled, Auto. Default setting is Auto . |
| Clean Victim FTI Cmd Balancing | Options available: Disabled, Enabled, Auto. Default setting is Auto . |
| CXL Strongly Ordered writes | Options available: Disabled, Enabled, Auto. Default setting is Disabled . |

5-3-2-1 Memory Addressing

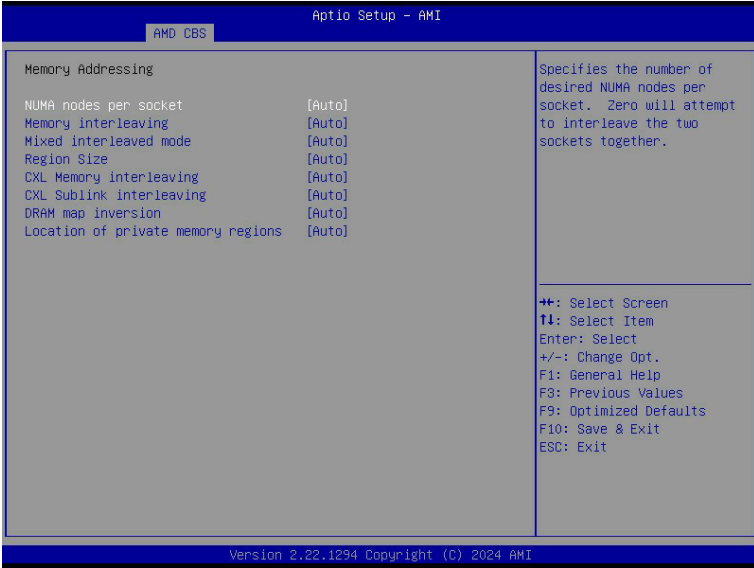

| Parameter | Description |
|------------------------------------|---|
| Memory Addressing | |
| NUMA nodes per socket | Specifies the number of desired NUMA nodes per socket. Options available: NPS0, NPS1, NPS2, NPS4, Auto. Default setting is Auto . NOTE! <ul style="list-style-type: none"> • Available options may vary by system configuration. • Only dual processor configuration supports NPS0. |
| Memory interleaving | Enable/Disable the Memory interleaving feature. Options available: Disabled, Auto, Enabled. Default setting is Auto . |
| Mixed interleaving mode | Allows for interleaving UMC and CXL together. Options available: Disabled, Auto, Enabled. Default setting is Auto . |
| Region Size | Options available: 1 K Region Size, 2K Region Size, Auto. Default setting is Auto . |
| CXL Memory interleaving | Options available: Disabled, Enabled, Auto. Default setting is Auto . |
| CXL Sublink interleaving | Options available: Enable, Disable, Auto. Default setting is Auto . |
| DRAM map inversion | Enable/Disable the DRAM map inversion function. Options available: Disabled, Enabled, Auto. Default setting is Auto . |
| Location of private memory regions | Controls whether or not the private memory regions (PSP, SMU and CC6) are at the top of DRAM or distributed. Options available: Distributed, Consolidated, Auto. Default setting is Auto . |

5-3-2-2 ACPI



| Parameter | Description |
|------------------------------------|--|
| ACPI | |
| ACPI SRAT L3 Cache As NUMA Domain | Enable/Disable report each L3 cache as a NUMA Domain to the OS. Options available: Disabled, Enabled, Auto. Default setting is Auto . |
| ACPI SLIT Distance Control | Determines how the SLIT distances are declared. Options available: Manual, Auto. Default setting is Auto . |
| ACPI SLIT remote relative distance | Sets the remote socket distance for 2P systems as near (2.8) or far (3.2). Options available: Near, Far, Auto. Default setting is Auto . |

5-3-2-3 Link

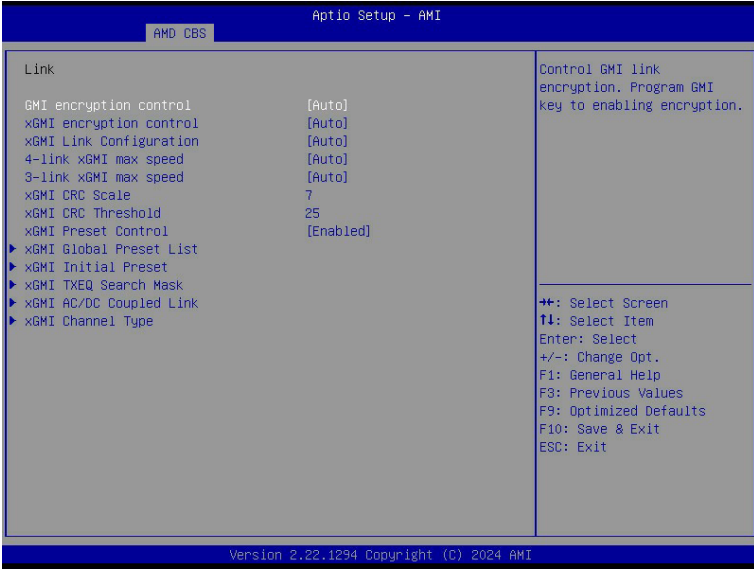

| Parameter | Description |
|-------------------------|--|
| GMI encryption control | Enable/Disable GMI link encryption. Options available: Disabled, Enabled, Auto. Default setting is Auto . |
| xGMI encryption control | Enable/Disable xGMI link encryption. Options available: Disabled, Enabled, Auto. Default setting is Auto . |
| xGMI Link Configuration | Configures the number of xGMI2 links used on a multi-socket system. Options available: Auto, 3 xGMI Links, 4 xGMI Links, 2 xGMI Links + 2 PCI Links. Default setting is Auto . |
| 4-link xGMI max speed | Specifies the max speed of 4-link xGMI. Options available: 20Gbps, 25Gbps, 32Gbps, Auto. Default setting is Auto . |
| 3-link xGMI max speed | Specifies the max speed of 3-link xGMI. Options available: 20Gbps, 25Gbps, 32Gbps, Auto. Default setting is Auto . |
| xGMI CRC Scale | Configures leaky bucket scale for xGMI and WAFL CRC errors. Every scale milliseconds an error will leak from the CRC counter. Default setting is 5 . |
| xGMI CRC Threshold | Configures leaky bucket threshold for xGMI and WAFL CRC errors. If link CRC counter exceeds this threshold, an error will be logged. Default setting is 25 . |
| xGMI Preset Control | Enable/Disable xGMI Preset control. Options available: Disabled, Enabled, Auto. Default setting is Enabled . |
| xGMI Global Preset List | Press [Enter] to configure the xGMI Preset list. |
| xGMI Initial Preset | Press [Enter] to configure the xGMI Initial Preset CPU link. |
| xGMI TXEQ Search Mask | Press [Enter] to configure the xGMI TXEQ Search Mask CPU link. |

| Parameter | Description |
|-------------------------|---|
| xGMI AC/DC Coupled Link | Press [Enter] to configure the xGMI AC/DC Coupled link. ♦ xGMI AC/DC Coupled Link Control ^(Note) – Options available: Manual, Auto. Default setting is Auto . |
| xGMI Channel Type | Press [Enter] to configure the xGMI Channel Type. ♦ xGMI Channel Type Control ^(Note) – Options available: Manual, Auto. Default setting is Auto . |

(Note) Advanced items prompt when this item is defined.

5-3-2-4 SDCI

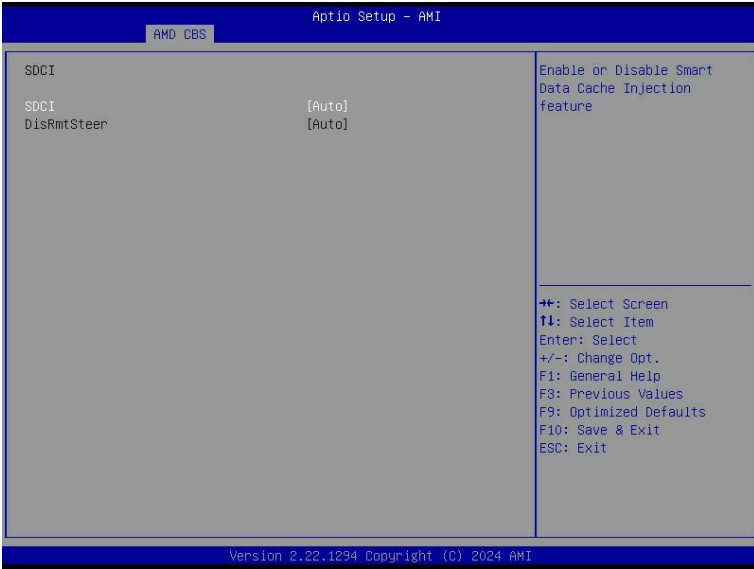

| Parameter | Description |
|------------------------|--|
| SDCI ^(Note) | Options available: Disabled, Enabled, Auto. Default setting is Auto . |
| DisRmSteer | Options available: Disabled, Enabled, Auto. Default setting is Auto . |

(Note) Advanced items prompt when this item is defined.

5-3-2-5 Probe Filter

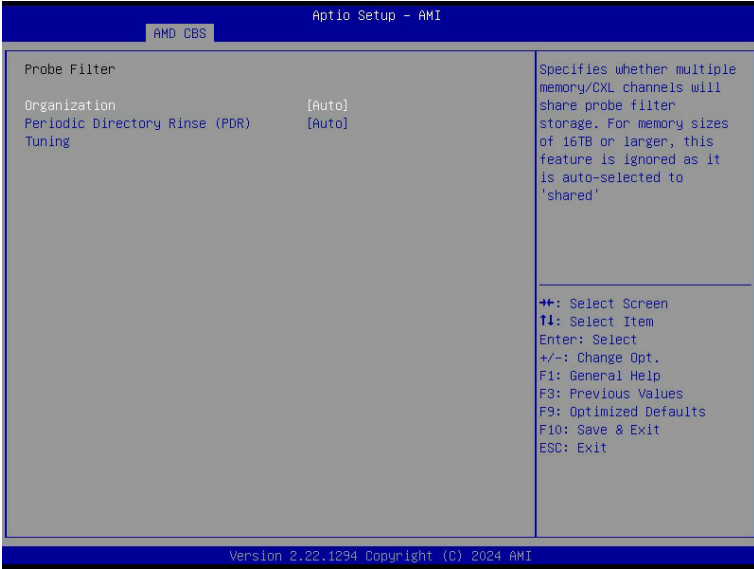

| Parameter | Description |
|---------------------------------------|--|
| Organization | Specifies whether multiple memory/CXL channels will share probe filter storage. Options available: Auto, Dedicated, Shared. Default setting is Dedicated . |
| Periodic Directory Rinse (PDR) Tuning | Controls PDR settings that may impact performance by workload and/or processor. Options available: Memory-Sensitive, Cache-Bound, Neutral, Adaptive, Auto. Default setting is Auto . |

5-3-3 UMC Common Options

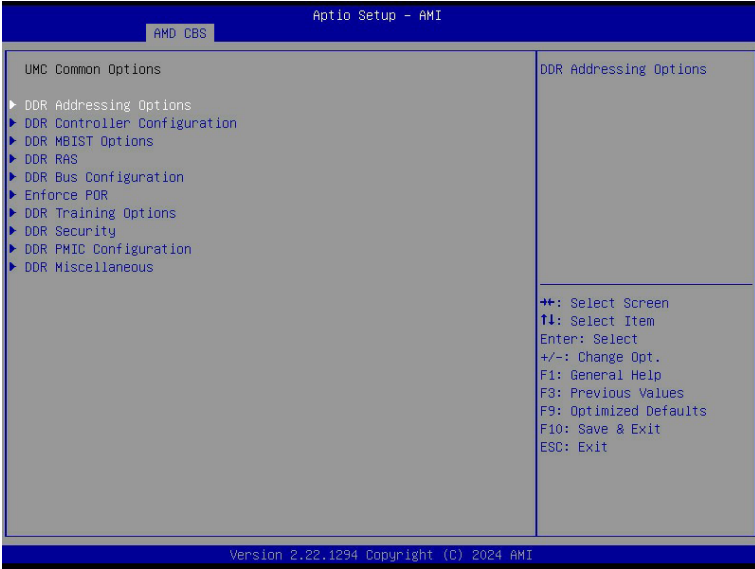

| Parameter | Description |
|------------------------------|--|
| UMC Common Options | |
| DDR Addressing Options | Press [Enter] for configuration of advanced items. |
| DDR Controller Configuration | Press [Enter] for configuration of advanced items. |
| DDR MBIST Options | Press [Enter] for configuration of advanced items. |
| DDR RAS | Press [Enter] for configuration of advanced items. |
| DDR Bus Configuration | Press [Enter] for configuration of advanced items. |
| Enforce POR | Press [Enter] for configuration of advanced items. |
| DDR Training Options | Press [Enter] for configuration of advanced items. |
| DDR Security | Press [Enter] for configuration of advanced items. |
| DDR PMIC Configuration | Press [Enter] for configuration of advanced items. |
| DDR Miscellaneous | Press [Enter] for configuration of advanced items. |

5-3-3-1 DDR Addressing Options

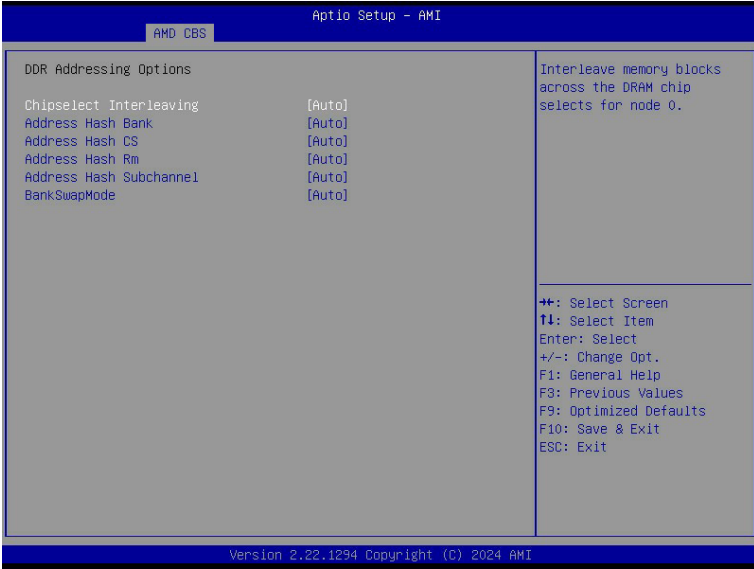

| Parameter | Description |
|-------------------------|---|
| DDR Addressing Options | |
| Chipselect Interleaving | Interleaves memory blocks across the DRAM chip selects for node 0. Options available: Disabled, Auto. Default setting is Auto . |
| Address Hash Bank | Enable or disable bank addressing hashing. Options available: Disabled, Enabled, Auto. Default setting is Auto . |
| Address Hash CS | Enable or disable CS addressing hashing. Options available: Auto, Enabled, Disabled. Default setting is Auto . |
| Address Hash RM | Enable or disable RM addressing hashing for 3DS DIMMs. Options available: Auto, Enabled, Disabled. Default setting is Auto . |
| Address Hash Subchannel | Enable or disable sub-channel addressing hashing. Options available: Auto, Enabled, Disabled. Default setting is Auto . |
| BankSwapMode | Options available: Auto, Disabled, Swap CPU. Default setting is Auto . |

5-3-3-2 DDR Controller Configuration

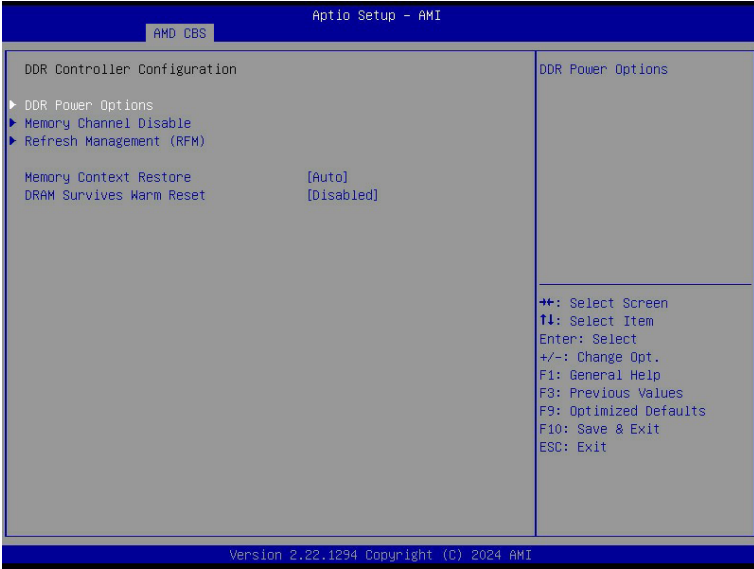

| Parameter | Description |
|------------------------------|--|
| DDR Controller Configuration | |
| DDR Power Options | Press [Enter] for configuration of advanced items. |
| Memory Channel Disable | Press [Enter] for configuration of advanced items. |
| Refresh Management (RFM) | Press [Enter] for configuration of advanced items. |
| Memory Context Restore | Options available: Disabled, Enabled, Auto. Default setting is Auto . |
| DRAM Survives Warm Reset | Options available: Disabled, Enabled. Default setting is Disabled . |

5-3-3-2-1 DDR Power Options

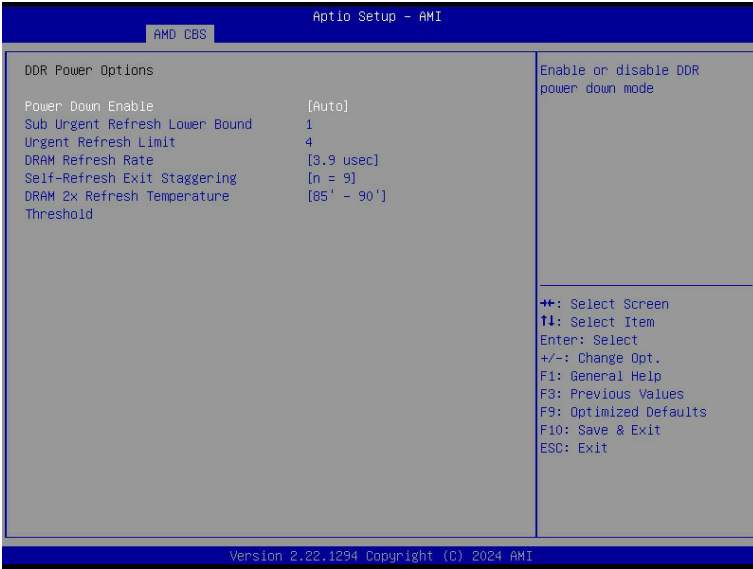

| Parameter | Description |
|---------------------------------------|--|
| DDR Power Options | |
| Power Down Enable | Enable or disable DDR power down mode. Options available: Disabled, Enabled, Auto. Default setting is Auto . |
| Sub Urgent Refresh Lower Bound | Specifies the stored refresh limit required to enter sub-urgent refresh mode. |
| Urgent Refresh Limit | Specifies the stored refresh limit required to enter urgent refresh mode. |
| DRAM Refresh Rate | DRAM refresh rate: 1.95us or 3.9us. Options available: 3.9 usec, 1.95 usec. Default setting is 3.9 usec . |
| Self-Refresh Exit Staggering | Options available: Disabled, n=1~9. Default setting is n=9 . |
| DRAM 2X Refresh Temperature Threshold | Options available: 85-100. Default setting is 85-90 . |

5-3-3-2-2 Memory Channel Disable

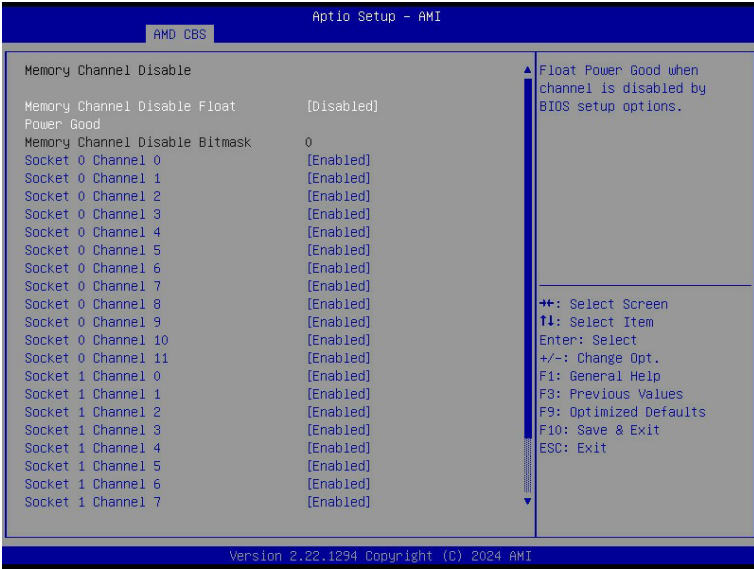

| Parameter | Description |
|---|--|
| Memory Channel Disable | |
| Memory Channel Disable Float Power Good | Options available: Disabled, Enabled. Default setting is Disabled . |
| Memory Channel Disable Bitmask | |
| CPU Channel_# | Press [Enter] to enable/disable specific memory channel. |

5-3-3-2-3 Refresh Management (RFM)

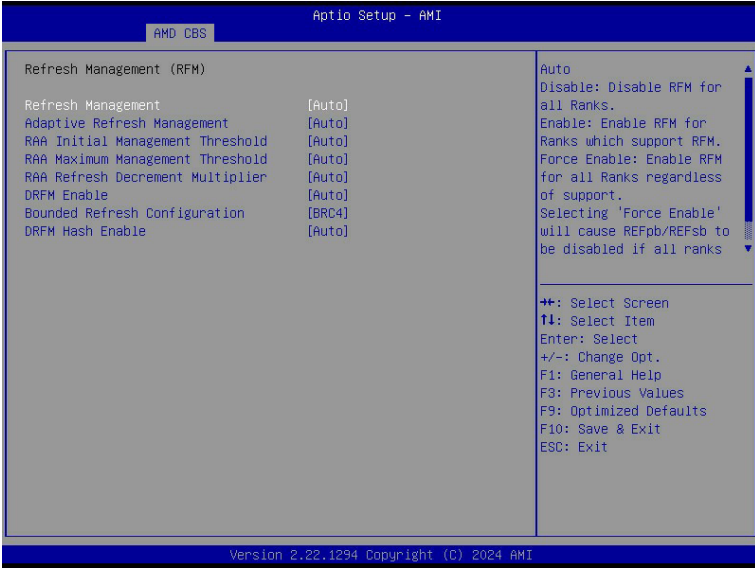

| Parameter | Description |
|----------------------------------|---|
| Refresh Management (RFM) | |
| Refresh Management | Configure Refresh Management. Options available: Enable, Disable, Auto, Force Enable. Default setting is Auto . |
| Adaptive Refresh Management | Options available: Auto, Disable, ARFM Level A, ARFM Level B, ARFM Level C. Default setting is Auto . |
| RAA Initial Management Threshold | Override Rolling Accumulated ACT Initial Management Threshold. Options available: 32, 40, 48, 56, 64, 72, 80, Auto. Default setting is Auto . |
| RAA Maximum Management Threshold | Override Rolling Accumulated ACT Maximum Management Threshold. Options available: 3X, 4X, 5X, 6X, Auto. Default setting is Auto . |
| RAA Refresh Decrement Multiplier | Override RAA Refresh Decrement Multiplier. Options available: 0.5, 1, Auto. Default setting is Auto . |
| DRFM | Options available: Disable, Enable, Auto. Default setting is Auto . |
| Bounded refresh Configuration | Options available: BRC2, BRC3, BRC4. Default setting is BRC4 . |
| DRFM Hash Enable | Options available: Disable, Enable, Auto. Default setting is Auto . |

5-3-3-3 DDR MBIST Options

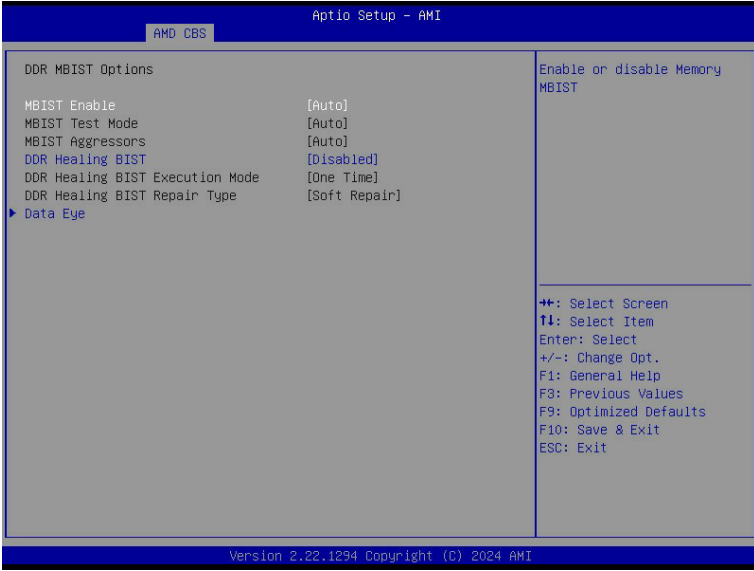

| Parameter | Description |
|--|--|
| DDR MBIST Options | |
| MBIST Enable | Enable/Disable the Memory MBIST function. Options available: Disabled, Enabled, Auto. Default setting is Auto . |
| MBIST Test Mode ^(Note1) | Selects MBIST Test Mode. Interface Mode: Tests Single and Multiple CS transactions and Basic Connectivity. Data Eye Mode: Measures Voltage vs. Timing. Options available: Auto, Both, Interface Mode, Data Eye Mode. Default setting is Auto . |
| MBIST Aggressors ^(Note1) | Enable/Disable MBIST Aggressor test. Options available: Auto, Enabled, Disabled. Default setting is Auto . |
| DDR Healing BIST | Options available: Disabled, PMU Mem BIST, Self-Healing Mem BIST, PMU and Self-Healing Mem BIST. Default setting is Disabled . |
| DDR Healing BIST Execution Mode ^(Note2) | Options available: One Time, Every boot. Default setting is One Time . |
| DDR Healing BIST Repair Type ^(Note2) | For DRAM errors found in the BIOS memory BIST select the repair type. Options available: Soft Repair, Hard Repair, No Repairs -Test only. Default setting is Soft Repair . |

(Note1) This item appears when **MBIST Enable** is set to **Enabled**.

| Parameter | Description |
|-----------|--|
| Data Eye | Press [Enter] to configure advanced items. |

(Note2) This item appears when **DDR Healing BIST** is defined.

5-3-3-3-1 Data Eye

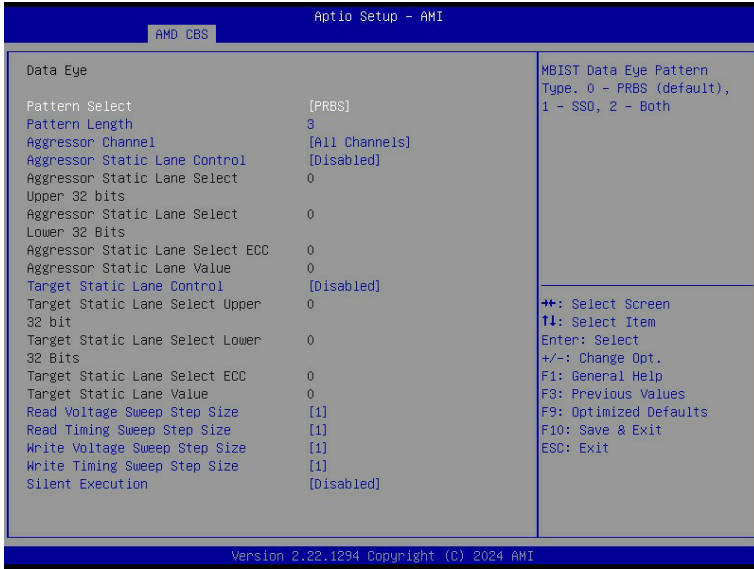

| Parameter | Description |
|--|--|
| Data Eye | |
| Pattern Select | Options available: PRBS, SSO, Both. Default setting is PRBS . |
| Pattern Length | Determines the pattern length. The possible options are N=3....12. |
| Aggressor Channel | This item helps read the aggressors channels. Options available: One Sub-Channel, Half Channels, All Channels. Default setting is All Channels . |
| Aggressor Static Lane Control | Enable/Disable the Aggressor Static Lane Control function. Options available: Enabled, Disabled. Default setting is Disabled . |
| Aggressor Static Lane Select Upper 32 bits | This item is configurable when Aggressor Static Lane Control is set to Enabled . |
| Aggressor Static Lane Select Lower 32 bits | This item is configurable when Aggressor Static Lane Control is set to Enabled . |
| Aggressor Static Lane Select ECC | This item is configurable when Aggressor Static Lane Control is set to Enabled . |
| Aggressor Static Lane Value | This item is configurable when Aggressor Static Lane Control is set to Enabled . |
| Target Static Lane Control | Enable/Disable the Target Static Lane Control function. Options available: Enabled, Disabled. Default setting is Disabled . |

| Parameter | Description |
|---|---|
| Target Static Lane Select Upper 32 bits | This item is configurable when Target Static Lane Control is set to Enabled . |
| Target Static Lane Select Lower 32 bits | This item is configurable when Target Static Lane Control is set to Enabled . |
| Target Static Lane Select ECC | This item is configurable when Target Static Lane Control is set to Enabled . |
| Target Static Lane Value | This item is configurable when Target Static Lane Control is set to Enabled . |
| Read Voltage Sweep Step Size | Configures the step size for read Data Eye voltage sweep. Options available: 1, 2, 4. Default setting is 1. |
| Read Timing Sweep Step Size | Configures the step size for read Data Eye timing sweep. Options available: 1, 2, 4. Default setting is 1. |
| Write Voltage Sweep Step Size | Configures the step size for write Data Eye voltage sweep. Options available: 1, 2, 4. Default setting is 1. |
| Write Timing Sweep Step Size | Configures the step size for write Data Eye timing sweep. Options available: 1, 2, 4. Default setting is 1. |
| Silent Execution | Execute MBIST Data Eye silently without ABL log output. Options available: Enabled, Disabled. Default setting is Disabled . |

5-3-3-4 DDR RAS

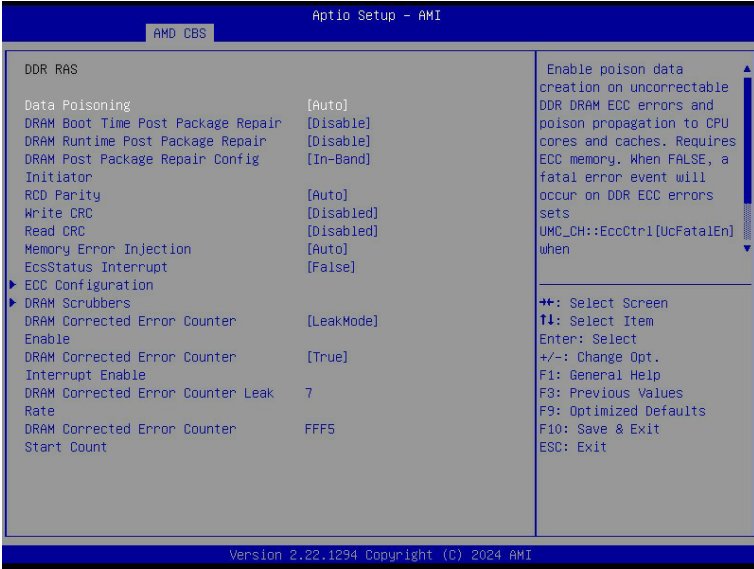

| Parameter | Description |
|---|--|
| DDR RAS | |
| Data Poisoning | Enable/Disable the Data Poisoning function. Options available: Auto, Enabled, Disabled. Default setting is Auto . |
| DRAM Boot Time Post Package Repair | Enable/Disable the DRAM Boot Time Post Package Repair function. Options available: Enable, Disable. Default setting is Disable . |
| DRAM Runtime Post Package Repair | Enable/Disable the DRAM Runtime Post Package Repair function. Options available: Enable, Disable. Default setting is Disable . |
| DRAM Post Package Repair Config Initiator | Options available: In-Band, Out of Band. Default setting is In-Band . |
| RCD Parity | Enable/Disable the RCD Parity function. Options available: Auto, Enabled, Disabled. Default setting is Enabled . |
| Write CRC | Options available: Auto, Enabled, Disabled. Default setting is Disabled . |
| Read CRC | Options available: Auto, Enabled, Disabled. Default setting is Disabled . |
| Memory Error Injection | Options available: False, True, Auto. Default setting is Auto . |
| EcsStatus Interrupt | Options available: False, True. Default setting is False . |
| ECC Configuration | Press [Enter] to configure advanced items. <ul style="list-style-type: none"> ◆ DRAM ECC Symbol Size <ul style="list-style-type: none"> – Configures the DRAM ECC Symbol Size. – Options available: Auto, x4, x16. Default setting is Auto. |

| Parameter | Description | |
|----------------------------------|--|--|
| ECC Configuration (continued) | <ul style="list-style-type: none"> ◆ DRAM ECC Enable <ul style="list-style-type: none"> – Enable/Disable DRAM ECC. When set to Auto, it will set ECC to enable. – Options available: Auto, Enabled, Disabled. Default setting is Auto. ◆ DRAM UECC Retry <ul style="list-style-type: none"> – Enable/Disable DRAM UECC Retry. – Options available: Auto, Enabled, Disabled. Default setting is Disabled. ◆ Max DRAM UECC Error Replay^(Note) <ul style="list-style-type: none"> – Default setting is 8. ◆ Memory Clear <ul style="list-style-type: none"> – Options available: Auto, Enabled, Disabled. Default setting is Auto. ◆ Address XOR after ECC <ul style="list-style-type: none"> – Options available: Auto, Enabled, Disabled. Default setting is Auto. ◆ CypherText Hiding Enable <ul style="list-style-type: none"> – Options available: Disable, Enable. Default setting is Disable. | |
| | DRAM Scrubbers | <p data-bbox="396 704 732 725">Press [Enter] to configure advanced items.</p> <ul style="list-style-type: none"> ◆ DRAM ECS Mode <ul style="list-style-type: none"> – Options available: Auto, AutoECS, ManualECS, DisableECS. Default setting is Auto. ◆ DRAM Redirect Scrubber Enable <ul style="list-style-type: none"> – Options available: Auto, Enabled, Disabled. Default setting is Auto. ◆ DRAM Scrub Redirection Limit <ul style="list-style-type: none"> – Options available: Auto, 8 Scrubs, 4 Scrubs, 2 Scrubs, 1 Scrub. Default setting is Auto. ◆ DRAM Scrub Time <ul style="list-style-type: none"> – Options available: Disabled, 1 hour, 4 hours, 6 hours, 8 hours, 12 hours, 16 hours, 24 hours, 48 hours. Default setting is 24 Hours. ◆ ECS Config <ul style="list-style-type: none"> – DRAM Error Threshold Count <ul style="list-style-type: none"> » Options available: Auto, ETC_4, ETC_16, ETC_64, ETC_256, ETC_1024, ETC_4096. Default setting is Auto. – DRAM ECS Count Mode <ul style="list-style-type: none"> » Options available: Auto, Row Count Mode, Code Word Count Mode. Default setting is Auto. – DRAM AutoEcs during Self Refresh <ul style="list-style-type: none"> » Options available: Auto, AutoEcs Disabled, AutoEcs Enabled. Default setting is Auto. |

(Note) This item available when **DRAM UECC Retry** is set to **Enabled**.

| Parameter | Description |
|---|---|
| DRAM Scrubbers (continued) | <ul style="list-style-type: none"> – DRAM ECS WriteBack Suppression » Options available: Auto, Enable, Disable. Default setting is Auto. – DRAM X4 WriteBack Suppression » Options available: Auto, Enable, Disable. Default setting is Auto. |
| DRAM Corrected Error Counter Enable | Configure DRAM Corrected Error Counter function. Options available: Disable, NoLeakMode, LeakMode. Default setting is LeakMode . |
| DRAM Corrected Error Counter Interrupt Enable | Enable SMI when DRAM corrected Error Counter count exceeds the threshold value. Options available: False, True. Default setting is True . |
| DRAM Corrected Counter Leak Rate | Program Rate value for DRAM Corrected Error Counter function. Default setting is 7 . |
| DRAM Corrected Error Counter Start Count | Program starting value for DRAM Corrected Error Counter function. Default setting is FFF5 . |

5-3-3-5 DDR Bus Configuration



| Parameter | Description |
|------------------------------|---|
| DDR Bus Configuration | |
| P-State 0 Dram ODT Impedance | <p>Press [Enter] to configure advanced items.</p> <ul style="list-style-type: none"> ◆ RTT_NOM_WR P-State 0 <ul style="list-style-type: none"> – Default setting is Auto. ◆ RTT_NOM_RD P-State 0 <ul style="list-style-type: none"> – Default setting is Auto. ◆ RTT_WR P-State 0 <ul style="list-style-type: none"> – Default setting is Auto. ◆ RTT_PARK P-State 0 <ul style="list-style-type: none"> – Default setting is Auto. ◆ DQS_RTT PARK P-State 0 <ul style="list-style-type: none"> – Default setting is Auto. |
| P-State 1 Dram ODT Impedance | <p>Press [Enter] to configure advanced items.</p> <ul style="list-style-type: none"> ◆ RTT_NOM_WR P-State 1 <ul style="list-style-type: none"> – Default setting is Auto. ◆ RTT_NOM_RD P-State 1 <ul style="list-style-type: none"> – Default setting is Auto. ◆ RTT_WR P-State 1 <ul style="list-style-type: none"> – Default setting is Auto. ◆ RTT_PARK P-State 1 <ul style="list-style-type: none"> – Default setting is Auto. ◆ DQS_RTT PARK P-State 1 <ul style="list-style-type: none"> – Default setting is Auto. |

| Parameter | Description |
|-----------------------------------|--|
| Processor ODT Pull Up impedance | Select the ODT impedance for all DBYTE IOs. Options available: Auto, High Impedance, 480 ohm, 240 ohm, 160 ohm, 120 ohm, 96 ohm, 80 ohm, 68.6 ohm, 60 ohm, 53.3 ohm, 48 ohm, 43.6 ohm, 40 ohm, 36.9 ohm, 34.3 ohm, 32 ohm, 30 ohm, 28.2 ohm, 26.7 ohm, 25.3 ohm. Default setting is Auto . |
| Processor ODT Pull Down impedance | Select the ODT pull down impedance for all DBYTE IOs. Options available: Auto, High Impedance, 480 ohm, 240 ohm, 160 ohm, 120 ohm, 96 ohm, 80 ohm, 68.6 ohm, 60 ohm, 53.3 ohm, 48 ohm, 43.6 ohm, 40 ohm, 36.9 ohm, 34.3 ohm, 32 ohm, 30 ohm, 28.2 ohm, 26.7 ohm, 25.3 ohm. Default setting is Auto . |
| Dram DQ drive strengths | Select the Dram Pull-up and Pull-Down Output Driver Impedance for all DQ and DMI IOs. Options available: Auto, 48 ohm, 40 ohm, 34 ohm, Default setting is Auto . |

5-3-3-6 Enforce POR



| Parameter | Description |
|---|---|
| Enforce POR | Decline/Accept to configure the advanced items. |
| Accept | |
| Active Memory Timing Settings ^(Note) | Active memory Timing Settings. Options available: Auto, Enabled. Default setting is Auto . |
| Memory Target Speed | Specifies the memory target speed in MT/s. Options available: Auto, DDR3600, DDR4000, DDR4400, DDR4800, DDR5200, DDR5600, DDR6000, DDR6400. Default setting is Auto . |
| SPD Timing | Press [Enter] to configure advanced items. |
| Non-SPD Timing | Press [Enter] to configure advanced items. |

(Note) Advanced items prompt when this item is defined.

5-3-3-7 DDR Training Options

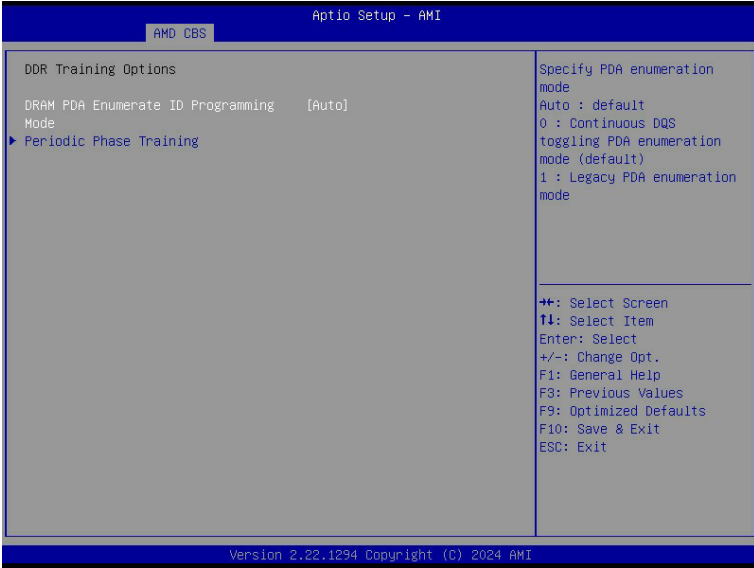

| Parameter | Description |
|--|--|
| DDR Training Options | |
| DRAM PDA Enumerate ID Programming Mode | Specify PDA enumeration mode. Options available: Auto, Toggling PDA enumeration mode, Legacy PDA enumeration mode. Default setting is Auto . |
| Periodic Phase Training | Press [Enter] to configure advanced items. <ul style="list-style-type: none"> ◆ Periodic Training Mode <ul style="list-style-type: none"> – Options available: Disabled Legacy. Default setting is Legacy. ◆ Periodic Interval <ul style="list-style-type: none"> – Periodic Interval value in milli-second, in decimal. Range 100-4095 ms. |

5-3-3-8 DDR Security

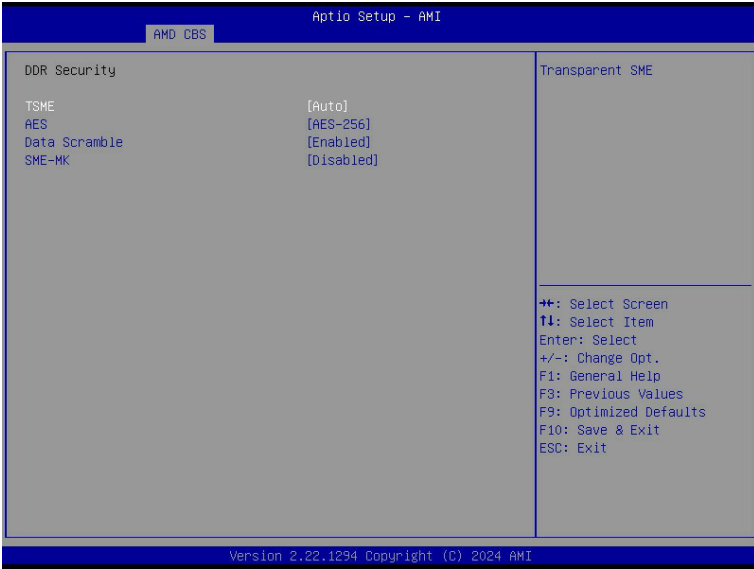

| Parameter | Description |
|---------------|---|
| Security | |
| TSME | Enable/Disable Transparent SME. Options available: Auto, Enabled, Disabled. Default setting is Auto . |
| AES | Options available: AES-128, AES-256. Default setting is AES-256 . |
| Data Scramble | Enable/Disable Data Scrambling. Options available: Enabled, Disabled. Default setting is Enabled . |
| SME-MK | Options available: Enabled, Disabled. Default setting is Disabled . |

5-3-3-9 DDR PMIC Configuration

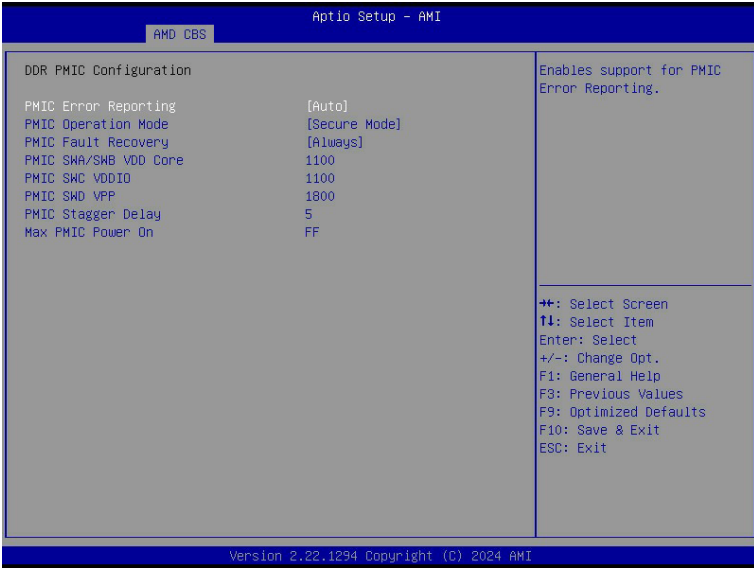

| Parameter | Description |
|------------------------|---|
| DDR PMIC Configuration | |
| PMIC Error Reporting | Enables support for PMIC Error Reporting. Options available: Auto, False, True. Default setting is Auto . |
| PMIC Operation Mode | Options available: Secure Mode, Programmable Mode. Default setting is Programmable Mode . |
| PMIC Fault Recovery | Options available: Always, Never, Once. Default setting is Always . |
| PMIC SWA/SWB VDD Core | Default setting is 1100 . |
| PMIC SWC VDDIO | Default setting is 1100 . |
| PMIC SWD VPP | Default setting is 1800 . |
| PMIC Stagger Delay | Default setting is 5 . |
| Max PMIC Power On | Default setting is FF . |

5-3-3-10 DDR Miscellaneous

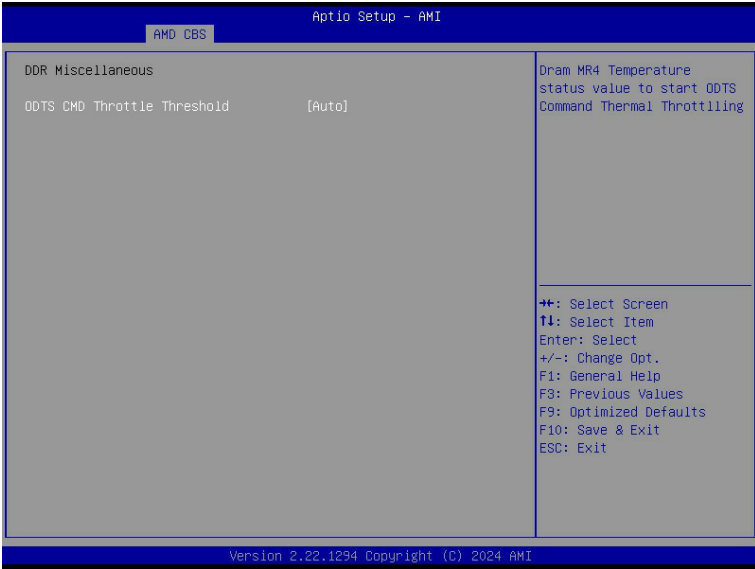

| Parameter | Description |
|-----------------------------|---|
| DDR Miscellaneous | |
| ODTS CMD Throttle Threshold | Options available: Auto, > 85°C, > 90°C, > 95°C. Default setting is Auto . |

5-3-4 NBIO Common Options

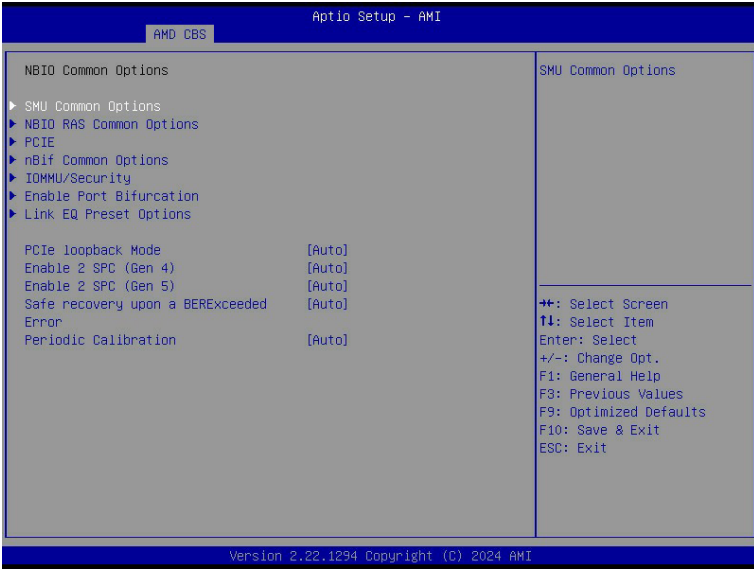

| Parameter | Description |
|--|--|
| NBIO Common Options | |
| SMU Common Options | Press [Enter] for configuration of advanced items. |
| NBIO RAS Common Options | Press [Enter] for configuration of advanced items. |
| PCIE | Press [Enter] for configuration of advanced items. |
| nBif Common Options | Press [Enter] for configuration of advanced items. |
| IOMMU/Security | Press [Enter] for configuration of advanced items. |
| Enable Port Bifurcation | Press [Enter] for configuration of advanced items. |
| Link EQ Present Options | Press [Enter] for configuration of advanced items. |
| PCIe loopback Mode | Options available: Disabled, Enabled, Auto. Default setting is Auto . |
| Enable 2SPC (Gen 4) | Options available: Disabled, Enabled, Auto. Default setting is Auto . |
| Enable 2SPC (Gen 5) | Options available: Disabled, Enabled, Auto. Default setting is Auto . |
| Safe recovery upon a BERExceeded Error | Options available: Disabled, Enabled, Auto. Default setting is Auto . |
| Periodic Calibration | Options available: Disabled, Enabled, Auto. Default setting is Auto . |

5-3-4-1 SMU Common Options

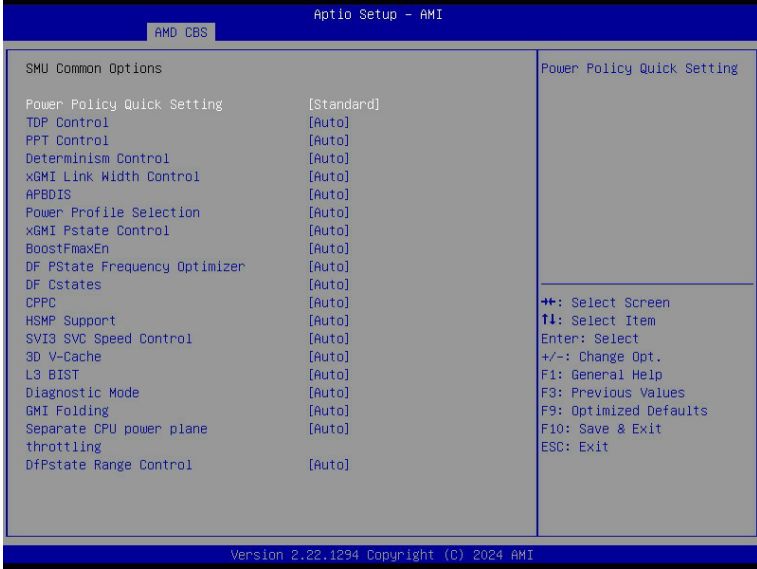

| Parameter | Description |
|-------------------------------|---|
| SMU Common Options | |
| Power Policy Quick Setting | Options available: Standard, Best Performance, Energy Efficient. Default setting is Standard . |
| TDP Control | Options available: Manual, Auto. Default setting is Auto . |
| PPT Control | Options available: Manual, Auto. Default setting is Auto . |
| Determinism Control | Selects use the fused Determinism or set customized Determinism. Options available: Manual, Auto. Default setting is Auto . |
| xGMI Link Width Control | Options available: Manual, Auto. Default setting is Auto . |
| APBDIS | Options available: 0, 1, Auto. Default setting is Auto . |
| Power Profile Selection | Options available: High Performance Mode, Efficiency Mode, Maximum IO Performance Mode. Default setting is High Performance Mode . |
| xGMI Pstate Control | Options available: Manual, Auto. Default setting is Auto . |
| BoostFmaxEn | Options available: Manual, Auto. Default setting is Auto . |
| DF PState Frequency Optimizer | Options available: Auto, Enabled, Disabled. Default setting is Auto . |
| DF Cstates | Options available: Disabled, Enabled, Auto. Default setting is Disabled . |

| Parameter | Description |
|-------------------------------------|--|
| CPPC | Enable/Disable the CPPC feature. Options available: Disabled, Enabled, Auto. Default setting is Auto . |
| HSMP Support | Enable/Disable the HSMP support. Options available: Disabled, Enabled, Auto. Default setting is Auto . |
| SVI3 SVC Speed Control | Options available: Auto, Manual. Default setting is Auto . |
| 3D V-Cache | Options available: Auto, Disable, 1 stack, 2 stack, 4 stack. Default setting is Auto . |
| L3 BIST | Options available: Auto, Disable, Enable. Default setting is Auto . |
| Diagnostic Mode | Options available: Disabled, Enabled, Auto. Default setting is Auto . |
| GMI Folding | Options available: Disabled, Enabled, Auto. Default setting is Auto . |
| Separate CPU power plane throttling | Options available: Auto, Disable, Enable. Default setting is Auto . |
| DfPstate Range Support | Options available: Disable, Enable, Auto. Default setting is Auto . |

5-3-4-2 NBIO RAS Common Options

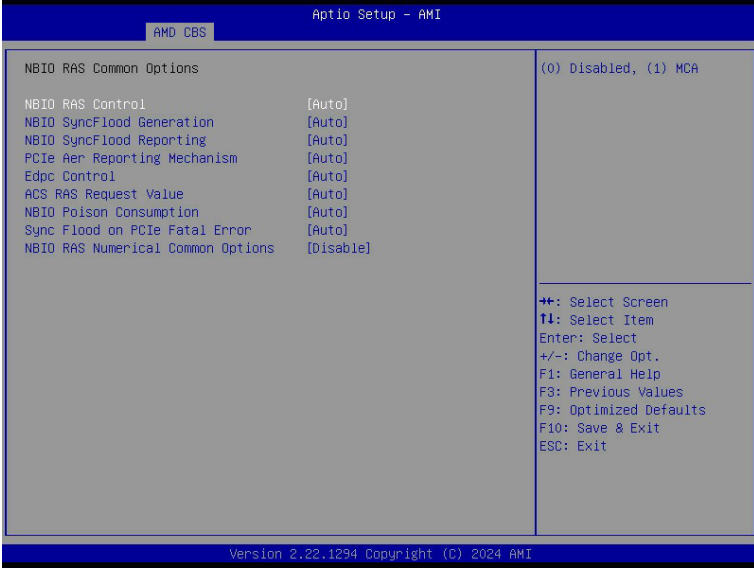

| Parameter | Description |
|-----------------------------------|---|
| NBIO RAS Common Options | |
| NBIO RAS Control | Options available: Disabled, MCA, Auto. Default setting is Auto . |
| NBIO SyncFlood Generation | The value may be used to mask SyncFlood caused by NBIO RAS options. Options available: Enabled, Disabled, Auto. Default setting is Auto . |
| NBIO SyncFlood Reporting | The value may be used to enable SyncFlood reporting to APML. Options available: Enabled, Disabled, Auto. Default setting is Auto . |
| PCIe Aer Reporting Mechanism | Selects the method of reporting AER errors from PCI Express. Options available: Firmware First, Firmware First but allow OS First, OS First, Auto. Default setting is Auto . |
| Edpc Control | Options available: Disabled, Enabled, Auto. Default setting is Auto . |
| ACS RAS Request Value | Options available: Direct Request Access Enabled, Request Blocking Enabled, Request Redirect Enabled, Auto. Default setting is Auto . |
| NBIO Poison Consumption | Options available: Auto, Enabled, Disabled. Default setting is Auto . |
| Sync Flood on PCIe Fatal Error | Options available: Auto, True, False. Default setting is Auto . |
| NBIO RAS Numerical Common Options | Options available: Disable, Manual. Default setting is Disable . |

5-3-4-3 PCIE

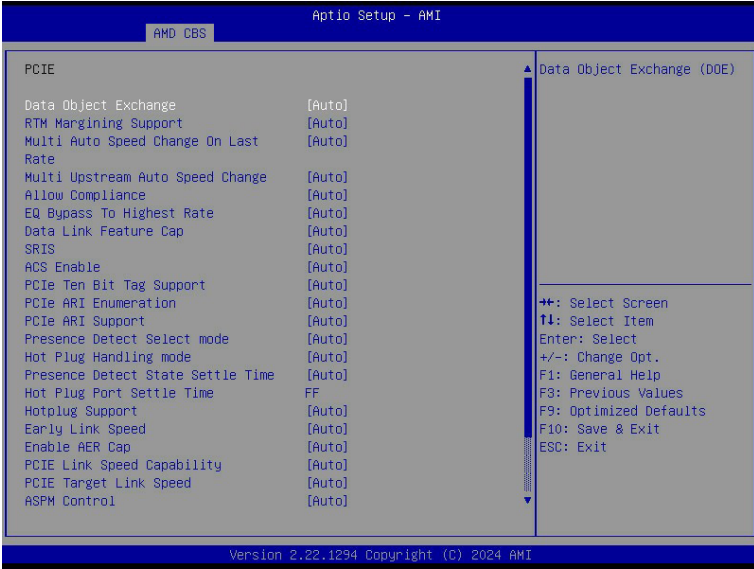

| Parameter | Description |
|--------------------------------------|---|
| PCIE | |
| Data Object Exchange | Options available: Auto, Disabled, Enabled. Default setting is Auto . |
| RTM Margining Support | Options available: Auto, Disable, Enable. Default setting is Auto . |
| Multi Auto Speed Change On Last Rate | Options available: Auto, Disable, Enable. Default setting is Auto . |
| Multi Upstream Auto Speed Change | Options available: Auto, Disabled, Enabled. Default setting is Auto . |
| Allow Compliance | When enabled, allows the PCIe RP to enter Polling.Compliance state. Options available: Auto, Disable, Enable. Default setting is Auto . |
| EQ Bypass To Highest Rate | Options available: Disable, Enable, Auto. Default setting is Auto . |
| Data Link Feature Cap | Options available: Auto, Disabled, Enabled. Default setting is Auto . |
| SRIS | Options available: Auto, Disable, Enable. Default setting is Auto . |
| ACS Enable | Enable/Disable ACS. Options available: Enable, Disabled, Auto. Default setting is Auto . |
| PCIe Ten Bit Tag Support | Enable/Disable PCIe ten bit tags for supported devices. (Auto=Disabled) Options available: Disable, Enable, Auto. Default setting is Auto . |
| PCIe ARI Enumeration | ARI Forwarding Enable for each downstream port. Options available: Disable, Enable, Auto. Default setting is Auto . |
| PCIe ARI Support | Enable/Disable Alternative Routing-ID Interpretation. Options available: Disable, Enable, Auto. Default setting is Auto . |
| Presence Detect Select mode | Controls the Presence Detect Select mode. Options available: OR, AND, Auto. Default setting is Auto . |
| Hot Plug Handling mode | Controls the Hot Plug Handling mode. Options available: OS First, Firmware First/EDR if OS supports, Firmware First but allow OS First, System Firmware Intermediary, Auto. Default setting is Auto . |
| Presence Detect State Settle Time | Options available: True, False, Auto. Default setting is Auto . |
| Hot Plug Port Settle Time | Configure Hot Plug Port Settle Time. |
| Hot Plug Support | Options available: Auto, Disabled. Default setting is Auto . |
| Early Link Speed | Configures Early Link Speed. Options available: Auto, Gen1, Gen2. Default setting is Auto . |
| Enable AER Cap | Enable/Disable Advanced Error Reporting Capability. Options available: Enable, Disabled, Auto. Default setting is Auto . |

| Parameter | Description |
|--|--|
| PCIe Link Speed Capability | Options available: Maximum speed, Gen1, Gen2, Gen3, Gen4, Gen5, Auto. Default setting is Auto . |
| PCIe Target Link Speed | Options available: Maximum Speed, GEN1, GEN2, GEN3, GEN4, GEN5, Auto. Default setting is Auto . |
| ASPM Control | Options available: Disable, L0s, L1, Auto. Default setting is Auto . |
| MCTP Enable | Options available: Enable, Disable, Auto. Default setting is Disable . |
| Non-PCIe Compliant Support | Options available: Enable, Disable, Auto. Default setting is Auto . |
| Limit hotplug devices to PCIe boot speed | Options available: Enable, Disable, Auto. Default setting is Auto . |

5-3-4-4 nBif Common Options

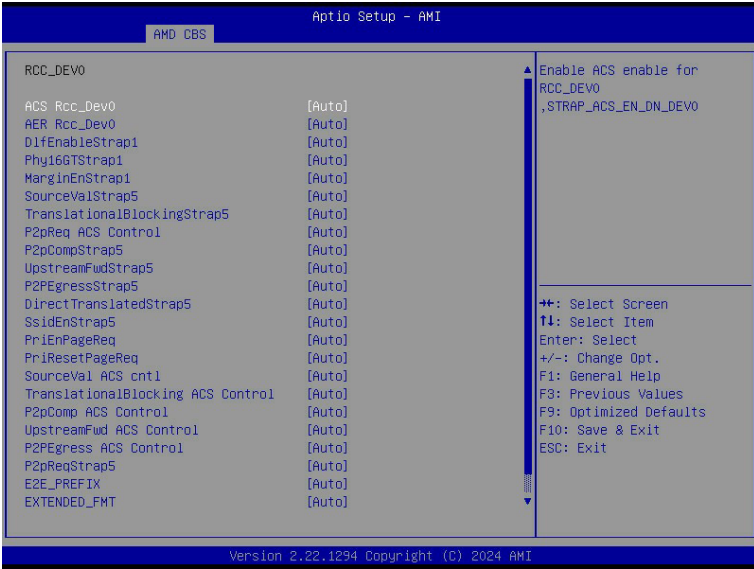

| Parameter | Description |
|-----------|--|
| RCC_DEVO | <ul style="list-style-type: none"> ◆ ACS_Rcc_Dev0 <ul style="list-style-type: none"> – Options available: Auto, Disabled, Enabled. Default setting is Auto. ◆ AER_Rcc_Dev0 <ul style="list-style-type: none"> – Options available: Auto, Disabled, Enabled. Default setting is Auto. ◆ DllEnableStrap1 <ul style="list-style-type: none"> – Options available: Auto, Disabled, Enabled. Default setting is Auto. ◆ Phy16GTStrap1 <ul style="list-style-type: none"> – Options available: Auto, Disabled, Enabled. Default setting is Auto. ◆ MarginEnStrap1 <ul style="list-style-type: none"> – Options available: Auto, Disabled, Enabled. Default setting is Auto. ◆ SourceValStrap5 <ul style="list-style-type: none"> – Options available: Auto, Disabled, Enabled. Default setting is Auto. ◆ TranslationalBlockingStrap5 <ul style="list-style-type: none"> – Options available: Auto, Disabled, Enabled. Default setting is Auto. ◆ P2pReq_ACS_Control <ul style="list-style-type: none"> – Options available: Auto, Disabled, Enabled. Default setting is Auto. ◆ P2pCompStrap5 <ul style="list-style-type: none"> – Options available: Auto, Disabled, Enabled. Default setting is Auto. ◆ UpstreamFwdStrap5 <ul style="list-style-type: none"> – Options available: Auto, Disabled, Enabled. Default setting is Auto. |

| Parameter | Description |
|-------------------------|---|
| RCC_DEV0 (continued) | <ul style="list-style-type: none"> ◆ P2PEgressStrap5 – Options available: Auto, Disabled, Enabled. Default setting is Auto. ◆ DirectTranslatedStrap5 – Options available: Auto, Disabled, Enabled. Default setting is Auto. ◆ SsidEnStrap5 – Options available: Auto, Disabled, Enabled. Default setting is Auto. ◆ PriEnPageReq – Options available: Auto, Disabled, Enabled. Default setting is Auto. ◆ PriResetPageReq – Options available: Auto, Disabled, Enabled. Default setting is Auto. ◆ SourceVal ACS cntl – Options available: Auto, Disabled, Enabled. Default setting is Auto. ◆ TranslationalBlocking ACS Control – Options available: Auto, Disabled, Enabled. Default setting is Auto. ◆ P2pComp ACS Control – Options available: Auto, Disabled, Enabled. Default setting is Auto. ◆ UpstreamFwd ACS Control – Options available: Auto, Disabled, Enabled. Default setting is Auto. ◆ P2PEgress ACS Control – Options available: Auto, Disabled, Enabled. Default setting is Auto. ◆ P2pReqStrap5 – Options available: Auto, Disabled, Enabled. Default setting is Auto. ◆ E2E_PREFIX – Options available: Auto, Disabled, Enabled. Default setting is Auto. ◆ EXTENDED_FMT – Options available: Auto, Disabled, Enabled. Default setting is Auto. ◆ AtomicRoutingStrap5 – Options available: Auto, Disabled, Enabled. Default setting is Auto. |

5-3-4-5 IOMMU/Security

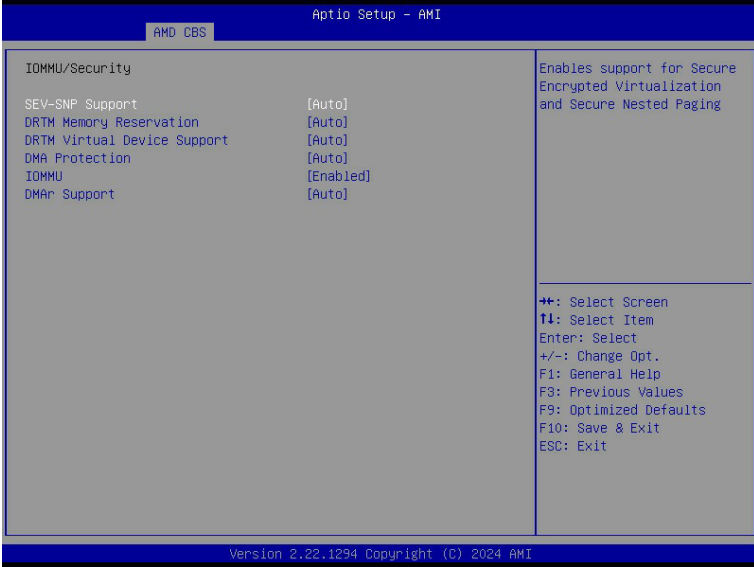

| Parameter | Description |
|-----------------------------|--|
| SEV-SNP Support | Enable/Disable the SEV-SNP support. Options available: Disable, Enable. Default setting is Disable . |
| DRTM Memory Reservation | Enable/Disable DRTM Memory reservation. Options available: Disabled, Enabled, Auto. Default setting is Auto . |
| DRTM Virtual Device Support | Enable/Disable DRTM ACPI virtual device. Options available: Disabled, Enabled, Auto. Default setting is Auto . |
| DMA Protection | Enable/Disable DMA remap support in IVRS IVinfo Field. Options available: Auto, Enabled, Disabled. Default setting is Auto . |
| IOMMU | Enable/Disable the IOMMU function. Options available: Disabled, Enabled. Default setting is Enabled . |
| DMAR Support | Enable/Disable DMAR system protection during POST. Options available: Disabled, Enabled, Auto. Default setting is Auto . |

5-3-4-6 Enable Port Bifurcation

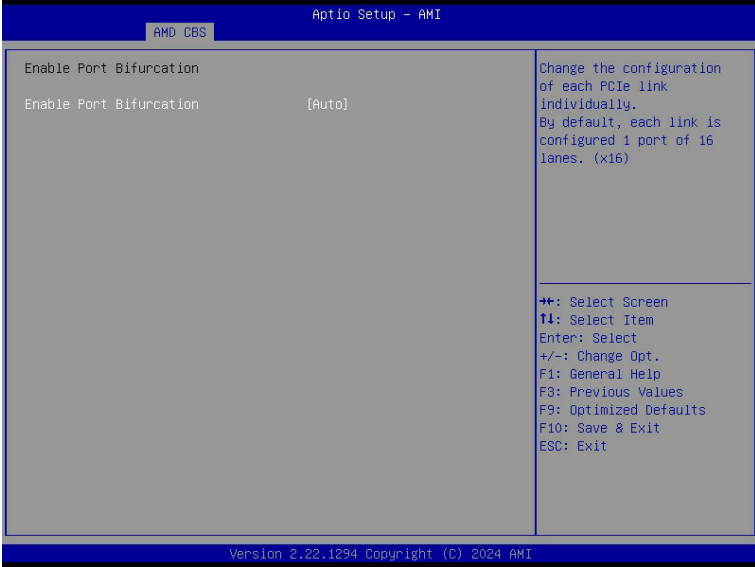

| Parameter | Description |
|--------------------------------------|--|
| Enable Bifurcation ^(Note) | Options available: Disable, Enable, Auto. Default setting is Auto . |
| Socket0 Slot Info Override | |

(Note) Advanced items prompt when this item is defined.

5-3-4-7 Link EQ Preset Options

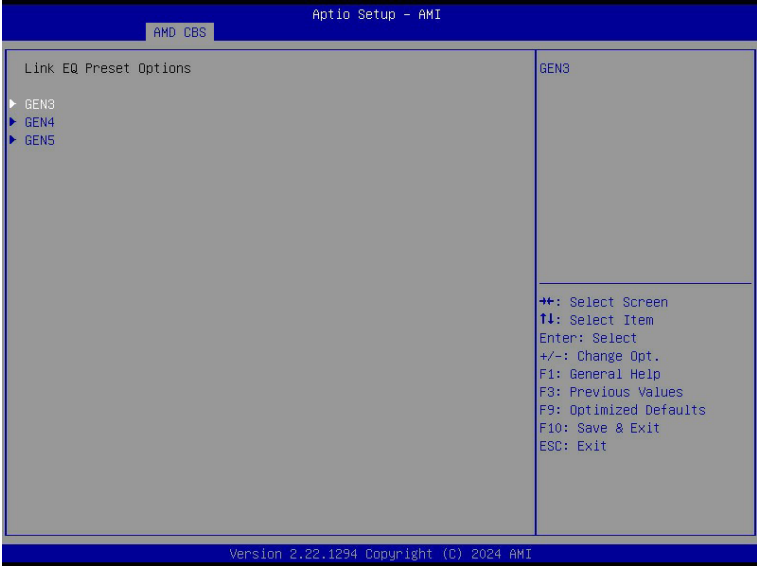

| Parameter | Description |
|-----------|---|
| GEN3/4/5 | Press [Enter] to configure advanced items. <ul style="list-style-type: none"> ◆ Preset Search Mask Configuration <ul style="list-style-type: none"> – Options available: Custom, Auto. Default setting is Auto. |

5-3-5 FCH Common Options

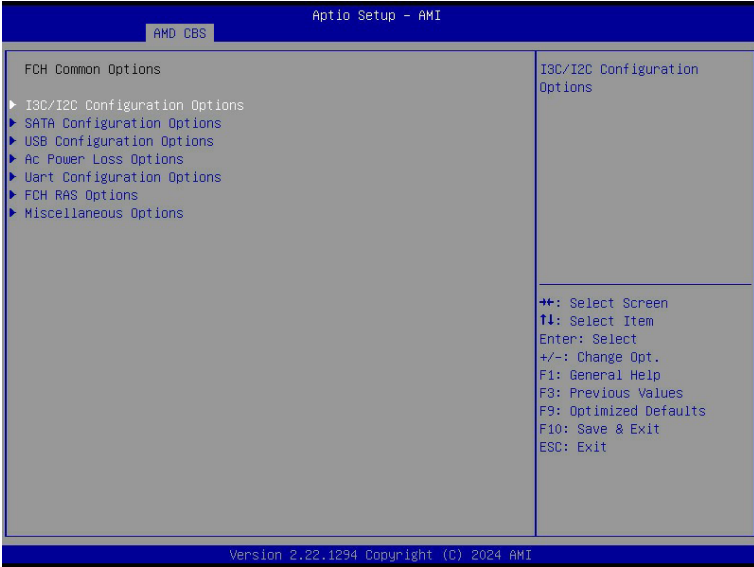

| Parameter | Description |
|-------------------------------|--|
| FCH Common Options | |
| I3C/I2C Configuration Options | Press [Enter] for configuration of advanced items. |
| SATA Configuration Options | Press [Enter] for configuration of advanced items. |
| USB Configuration Options | Press [Enter] for configuration of advanced items. |
| AC Power Loss Options | Press [Enter] for configuration of advanced items. |
| Uart Configuration Options | Press [Enter] for configuration of advanced items. |
| FCH RAS Options | Press [Enter] for configuration of advanced items. |
| Miscellaneous Options | Press [Enter] for configuration of advanced items. |

5-3-5-1 I3C/I2C Configuration Options

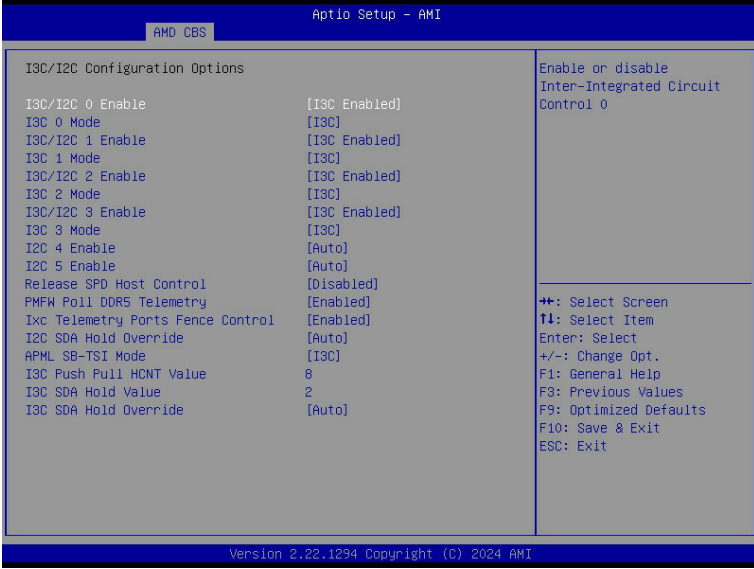

| Parameter | Description |
|-----------------------------------|--|
| I3C/I2C Configuration Options | |
| I3C/I2C 0/1/2/3 Enable | Options available: Both Disabled, I3C Enabled, I2C Enabled, Auto. Default setting is Auto . |
| I2C 4/5 Enable | Options available: Disabled, Enabled, Auto. Default setting is Auto . |
| Release SPD Host Control | Options available: Disabled, Enabled. Default setting is Disabled . |
| PMFW Poll DDR5 Telemetry | Options available: Disabled, Enabled. Default setting is Enabled . |
| Ixc Telemetry Ports Fence Control | Options available: Disabled, Enabled. Default setting is Disabled . |
| I2C SDA Hold Override | Options available: Disabled, Enabled, Auto. Default setting is Auto . |
| APML SB-TSI & RMI Mode | Options available: I3C, I2C. Default setting is I3C . |
| I3C Mode Speed | Options available: SDR2(6MHz), SDR0(12.5MHz), Auto. Default setting is Auto . |
| I3C Push Pull HCNT Value | SCL push-pull High count for I3C transfers targeted to I3C devices. |
| I3C SDA Hold Value | Specifies I3C SDA Hold value. |
| I3C SDA Hold Override | Override I3C SDA Hold value. Options available: Disabled, Enabled, Auto. Default setting is Auto . |

5-3-5-2 SATA Configuration Options

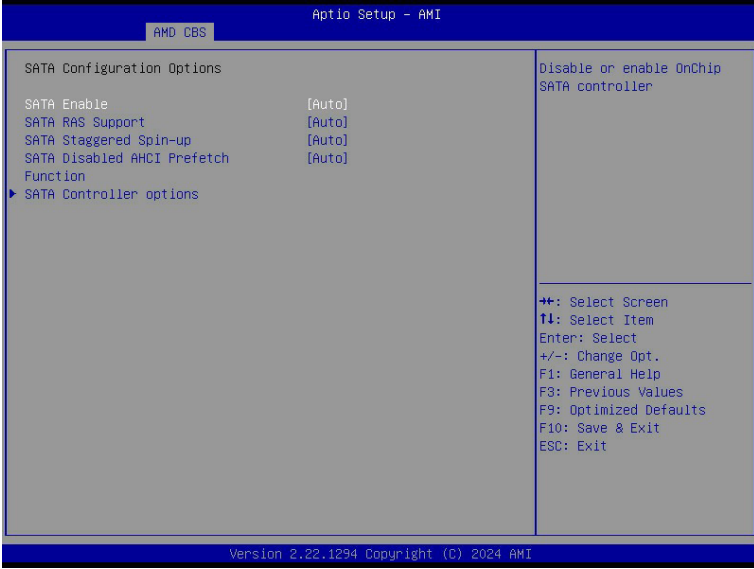

| Parameter | Description |
|--------------------------------------|---|
| SATA Configuration Options | |
| SATA Enable | Enable/Disable OnChip SATA controller. Options available: Disabled, Enabled, Auto. Default setting is Auto . |
| SATA RAS Support | Options available: Disabled, Enabled, Auto. Default setting is Auto . |
| SATA Staggered Spin-up | Options available: Disabled, Enabled, Auto. Default setting is Auto . |
| SATA Disabled AHCI Prefetch Function | Options available: Disabled, Enabled, Auto. Default setting is Auto . |
| SATA Controller options | Press [Enter] for configuration of advanced items. <ul style="list-style-type: none"> ◆ SATA Controller Enable ◆ SATA Controller eSATA ◆ SATA Controller DevSlp ◆ SATA Controller SGPIO |

5-3-5-3 USB Configuration Options

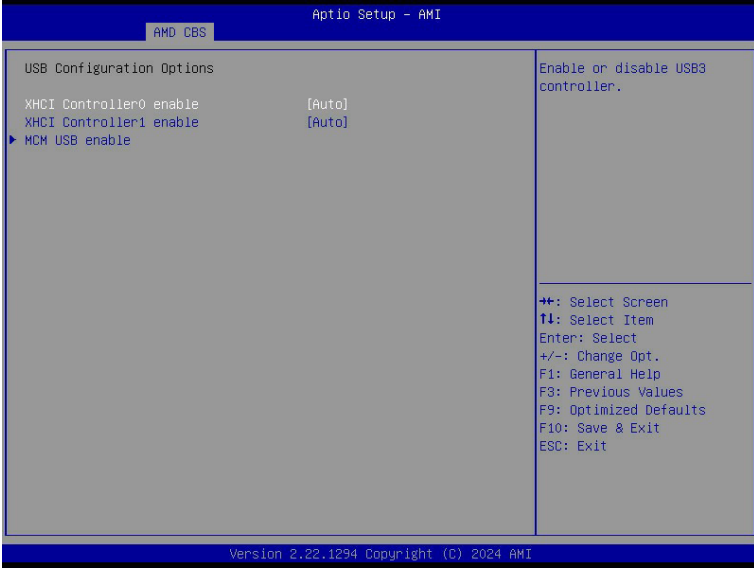

| Parameter | Description |
|---------------------------|---|
| USB Configuration Options | |
| XHCI Controller0/1 enable | Enable/Disable USB controller. Options available: Enabled, Disabled, Auto. Default setting is Auto . |
| MCM USB enable | Press [Enter] for configuration of advanced items. <ul style="list-style-type: none"> ◆ XHCI2/ XHCI3 enable (Socket1) <ul style="list-style-type: none"> – Options available: Enabled, Disabled, Auto. Default setting is Auto. |

5-3-5-4 AC Power Loss Options

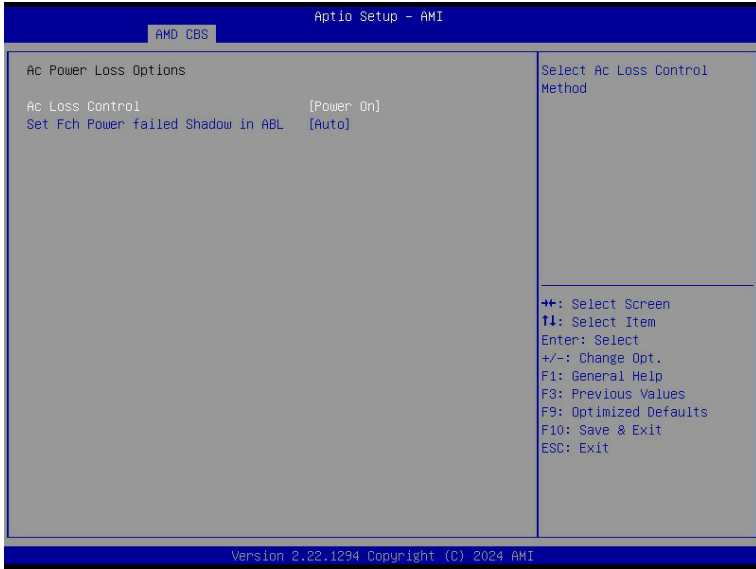

| Parameter | Description |
|------------------------------------|--|
| AC Power Loss Options | |
| AC Loss Control | Selects the AC Loss Control Method. Options available: Power Off, Power On, Last State. Default setting is Last State . |
| Set FCH Power failed shadow in ABL | Enable/Disable set FCH power failed shadow by AC Loss control policy in ABL. Options available: Enabled, Disabled, Auto. Default setting is Auto . |

5-3-5-5 Uart Configuration Options

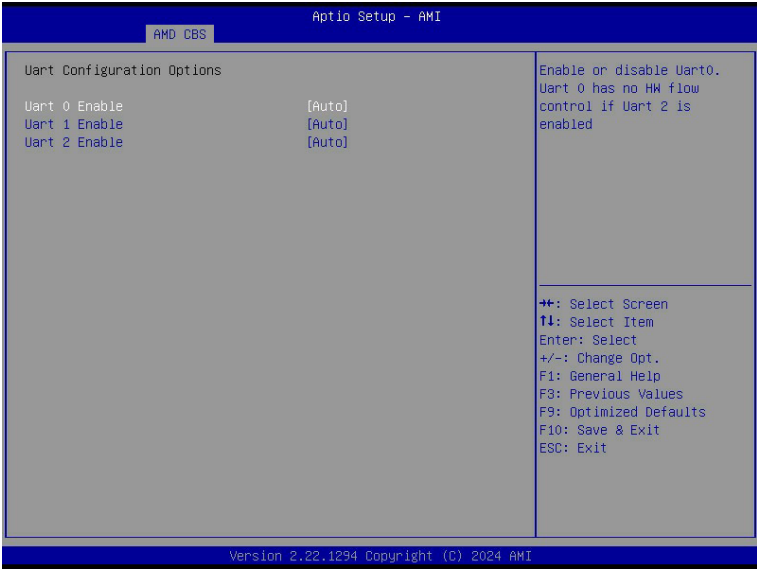

| Parameter | Description |
|----------------------------|--|
| Uart Configuration Options | |
| Uart 0/1/2/3 Enable | Options available: Disabled, Enabled, Auto. Default setting is Auto . |

5-3-5-6 FCH RAS Options

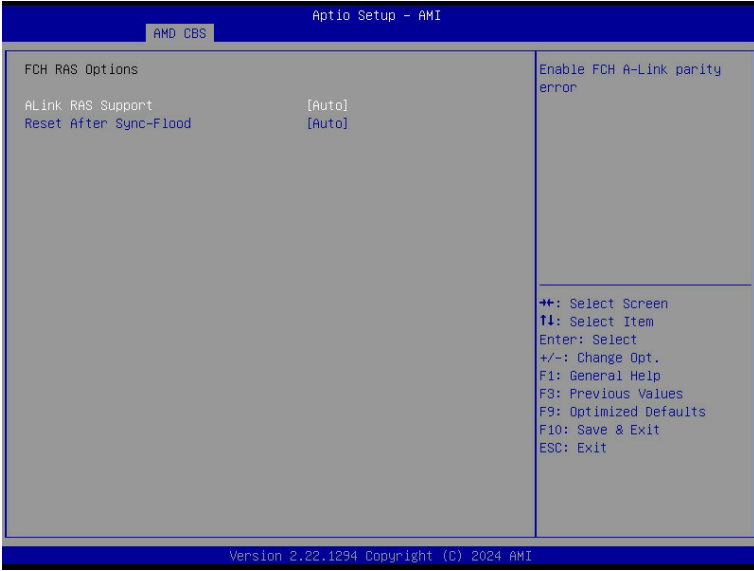

| Parameter | Description |
|------------------------|---|
| FCH RAS Options | |
| A-Link RAS Support | Enable/Disable the A-Link RAS Support. Options available: Disabled, Enabled, Auto. Default setting is Auto . |
| Reset After Sync-Flood | Enables AB to forward downstream sync-flood message to system controller. Options available: Enable, Disable, Auto. Default setting is Auto . |

5-3-5-7 Miscellaneous Options

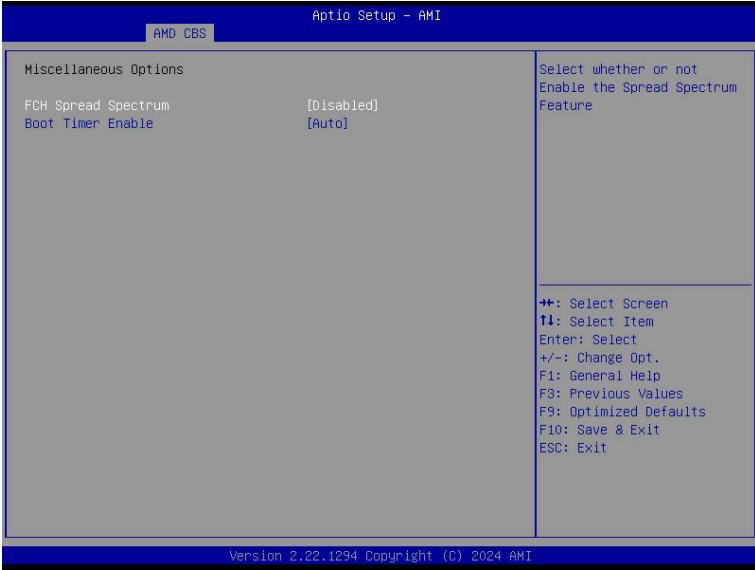

| Parameter | Description |
|-----------------------|---|
| Miscellaneous Options | |
| FCH Spread Spectrum | Select whether or not Enable the Spread Spectrum Feature. Options available: Disabled, Enabled, Auto. Default setting is Disabled . |
| Boot Timer Enable | Enable/Disable Boot Timer. Options available: Disabled, Enabled, Auto. Default setting is Auto . |

5-3-6 SOC Miscellaneous Control

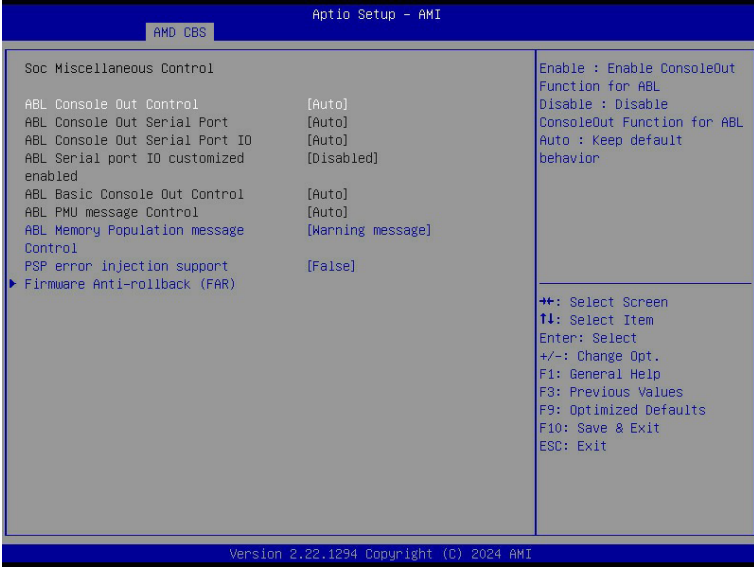

| Parameter | Description |
|---|--|
| SOC Miscellaneous Control | |
| ABL Console Out Control ^(Note) | Enable/Disable the ConsoleOut function for ABL. Options available: Disable, Enable, Auto. Default setting is Auto . |
| ABL Console Out Serial Port ^(Note) | Options available: eSPI, SOC UART0, SOC UART1, Auto. Default setting is Auto . |
| ABL Console Out Serial Port IO | Options available: 0x3F8, 0x2F8, 0x3E8, 0x2E8, Auto. Default setting is Auto . |
| ABL Serial port IO customized enabled | Options available: Disabled, Enabled. Default setting is Disabled . |
| ABL Basic Console Out Control | Enable/Disable the Basic ConsoleOut function for ABL. Options available: Disable, Enable, Auto. Default setting is Auto . |
| ABL PMU message Control | To Control the total number of PMU debug messages. Options available: Auto, Detailed debug message, Coarse debug message, Stage completion, Assertion messages, Firmware completion message only. Default setting is Auto . |
| ABL Memory Population message Control | Options available: Warning message, Fatal error. Default setting is Warning message . |

(Note) Advanced items are configurable when this item is defined.

| Parameter | Description |
|------------------------------|--|
| PSP error injection support | Options available: False, True. Default setting is False . |
| Firmware Anti-rollback (FAR) | Press [Enter] for configuration of advanced items. <ul style="list-style-type: none"> ◆ FAR enforcement state <ul style="list-style-type: none"> – Default setting is Enabled. ◆ SPL value in the CPU Fuse ◆ SPL value in the SPL table ◆ FAR Switch <ul style="list-style-type: none"> – Options available: Disabled, Enabled, Auto. Default setting is Auto. |

5-3-7 CXL Common Options

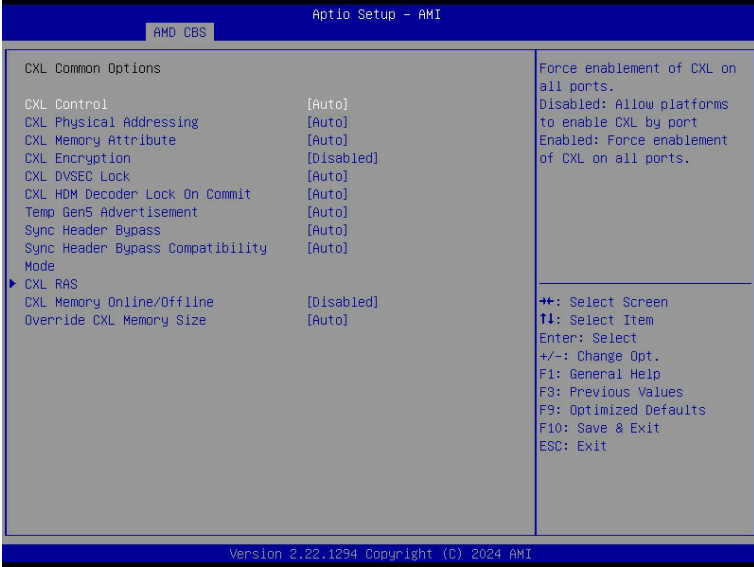

| Parameter | Description |
|---------------------------------------|---|
| CXL Common Options | |
| CXL Control | Options available: Auto, Enabled, Disabled. Default setting is Auto . |
| CXL Physical Addressing | Options available: Normalized address, System address, Auto. Default setting is Auto . |
| CXL Memory Attribute | Options available: Auto, Enabled, Disabled. Default setting is Auto . |
| CXL Encryption | Options available: Enabled, Disabled. Default setting is Disabled . |
| CXL DVSEC Lock | Options available: Auto, Enabled, Disabled. Default setting is Auto . |
| CXL HDM Decoder Lock on Commit | Options available: Auto, Enabled, Disabled. Default setting is Auto . |
| Temp Gen5 Advertisement | Options available: Disabled, Enabled, Auto. Default setting is Auto . |
| Sync Header Bypass | Options available: Auto, Enabled, Disabled. Default setting is Auto . |
| Sync Header Bypass Compatibility Mode | Options available: Auto, Enabled, Disabled. Default setting is Auto . |

| Parameter | Description |
|---------------------------|--|
| CXL RAS | <p>Press [Enter] for configuration of advanced items.</p> <ul style="list-style-type: none"> ◆ CXL Protocol Error Reporting <ul style="list-style-type: none"> – Options available: Disabled, SameAsPcieAer, ForceAerFwFirstIfCxlPresent. Default setting is SameAsPcieAer. ◆ CXL Component Error Reporting <ul style="list-style-type: none"> – Options available: Allow OS First, Force FW-First, Debug FW-First. Default setting is Debug FW-First. ◆ CXL Root Port Isolation <ul style="list-style-type: none"> – Options available: Auto, Enabled, Disabled. Default setting is Auto. ◆ CXL Root Port Isolation FW Notification. <ul style="list-style-type: none"> – Options available: Auto, Enabled, Disabled. Default setting is Auto |
| CXL Memory Online/Offline | <p>All 4 Plink sots support memory online/offline. Only slot4 of Amber supports hot plug CXL memory interleaving automatically disabled globally when this CBS is enabled.</p> <p>Options available: Enabled, Disabled. Default setting is Disabled.</p> |
| Override CXL Memory Size | <p>Options available: 32GB, 64GB, 128GB, Auto. Default setting is Auto.</p> |

5-4 AMD PBS Menu

AMD PBS Option menu displays submenu options for configuring the function of AMD PBS. Select a submenu item, then press [Enter] to access the related submenu screen.

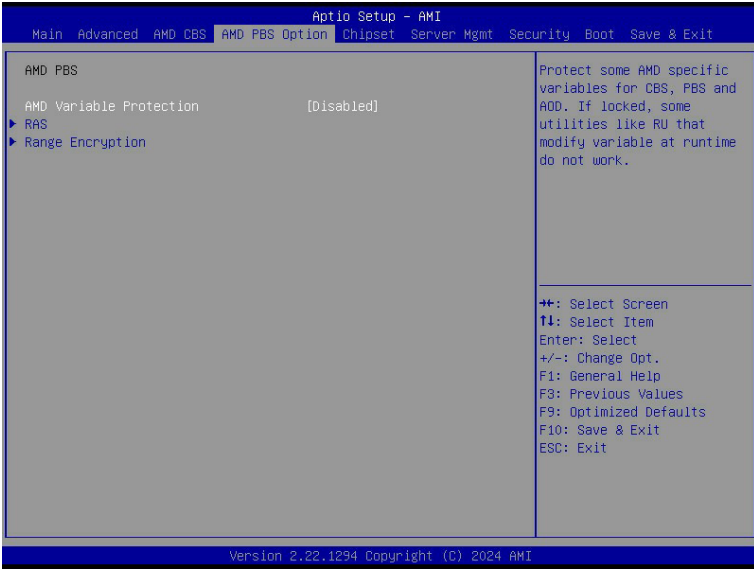

| Parameter | Description |
|-------------------------|--|
| AMD Variable Protection | Protect some AMD specific variables for CBS, PBS and AOD. If locked, some utilities like RU that modify variable at runtime do not work. Options available: Disabled, Enabled. Default setting is Disabled . |
| RAS | Press [Enter] for configuration of advanced items. |
| Range Encryption | Press [Enter] for configuration of advanced items. <ul style="list-style-type: none"> ◆ Range 1/2/3/4/5/6/7 <ul style="list-style-type: none"> – Configure the Range 1/2/3/4/5/6/7 Memory Base. – Configure the Range 1/2/3/4/5/6/7 Memory Limit/Size. ◆ Start Range Encryption |

5-4-1 RAS

| Aptio Setup - AMI | | |
|-------------------------------------|---------------|--|
| AMD PBS Option | | |
| RAS Periodic SMI Control | [Enabled] | Enable/ disable Periodic SMI for polling [MCA Threshold] error |
| SMI Threshold | 5 | |
| SMI Scale | 1000 | |
| SMI Scale Unit | [millisecond] | |
| SMI Period | 1000 | |
| <hr/> | | |
| GHEs Notify Type | [Polled] | |
| GHEs UnCorr Notify Type | [NMI] | |
| PCIe GHEs Notify Type | [Polled] | |
| PCIe UnCorr GHEs Notify Type | [NMI] | |
| PCIe Root Port Corr Err Mask Reg | FFFFFFFF | |
| PCIe Root Port UnCorr Err Mask Reg | 0 | |
| Pcie Root Port UnCorr Error Sev Reg | 57EF6030 | |
| <hr/> | | |
| Reg | | ++: Select Screen |
| PCIe Device Corr Err Mask Reg | FFFFFFFF | ↑↓: Select Item |
| PCIe Device UnCorr Err Mask Reg | 0 | Enter: Select |
| Pcie Device UnCorr Error Sev Reg | 57EF6030 | +/-: Change Opt. |
| CXL DP CIE Mask Enable | [Enabled] | F1: General Help |
| DRAM Hand Post Package Repair | [Disabled] | F3: Previous Values |
| HEST DMC Structure Support | [Disabled] | F9: Optimized Defaults |
| CXL Error Report Support | [Disabled] | F10: Save & Exit |
| | | ESC: Exit |

Version 2.22.1294 Copyright (C) 2024 AMI

| Parameter | Description |
|----------------------------------|--|
| RAS Periodic SMI Control | Enable/Disable the Periodic SMI for polling [MCA Threshold] error. Options available: Disabled, Enabled. Default setting is Enabled . |
| SMI Threshold | Configures the SMI Threshold value. |
| SMI Scale | Configures the SMI Scale value. |
| SMI Scale Unit | Defines the unit of time scale. Options available: millisecond, second, minute. Default setting is millisecond . |
| SMI Period | Configures the SMI Period. |
| GHEs Notify Type | Selects the Notification type for deferred/ corrected errors. Options available: Polled, SCI. Default setting is Polled . |
| GHEs UnCorr Notify Type | Selects the Notification type for uncorrected errors. Options available: Polled, NMI. Default setting is NMI . |
| PCIe GHEs Notify Type | Selects the Notification type for PCIe corrected errors. Options available: Polled, SCI. Default setting is Polled . |
| PCIe UnCorr GHEs Notify Type | Selects the Notification type for PCIe uncorrected errors. Options available: Polled, NMI. Default setting is NMI . |
| PCIe Root Port Corr Err Mask Reg | Initialize the PCIe AER Corrected Error Mask register of Root Port. |

| Parameter | Description |
|------------------------------------|--|
| PCIe Root Port UnCorr Err Mask Reg | Initialize the PCIe AER Uncorrected Error Mask register of Root Port. |
| PCIe Root Port UnCorr Err Sev Reg | Initialize the PCIe AER Uncorrected Error Severity register of Root Port. |
| PCIe Device Corr Err Mask Reg | Initialize the PCIe AER Corrected Error Mask register of PCIe device. |
| PCIe Device UnCorr Err Mask Reg | Initialize the PCIe AER Uncorrected Error Mask register of PCIe device. |
| PCIe Device UnCorr Err Sev Reg | Initialize the PCIe AER Uncorrected Error Severity register of PCIe device. |
| CXL DP CIE Mask Enable | Options available: Disabled, Enabled. Default setting is Enabled . |
| DRAM Hard Post Package Repair | This feature allows spare DRAM rows to replace malfunctioning rows via an in-field repair mechanism. Options available: Disabled, Enabled. Default setting is Disabled . |
| HEST DMC Structure Support | HEST DMC (Deferred Machine Check) Structure Support. Options available: Disabled, Enabled. Default setting is Disabled . |
| CXL Error Report Support | Enable/Disable CXL Error Reporting. Options available: Disabled, Enabled. Default setting is Disabled . |

5-5 Chipset Setup Menu

Chipset Setup menu displays submenu options for configuring the function of the North Bridge. Select a submenu item, then press <Enter> to access the related submenu screen.

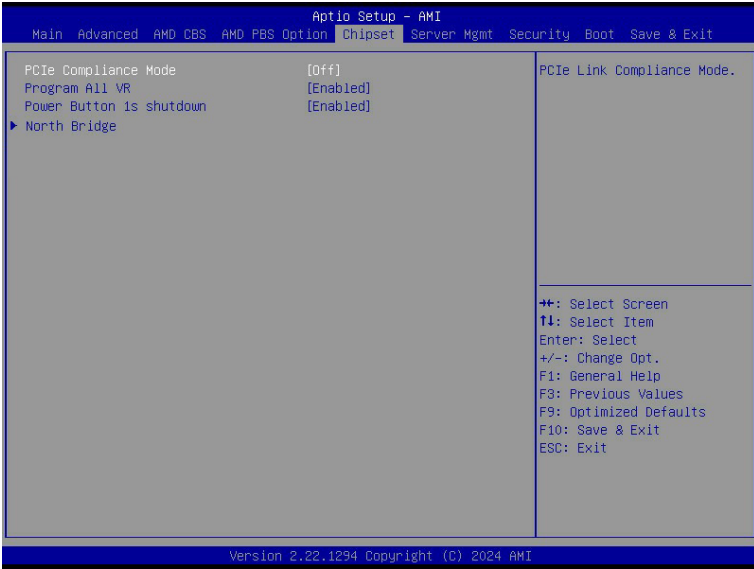

| Parameter | Description |
|--------------------------|--|
| PCIe Compliance Mode | Options available: Off, On. Default setting is Off . |
| Program All VR | Enable/Disable program all VR on MB. Options available: Disabled, Enabled. Default setting is Enabled . |
| Power Button 1s shutdown | Enable/Disable Press power button 1 sec shutdown. Options available: Disabled, Enabled. Default setting is Enabled . |
| North Bridge | Press [Enter] for configuration of advanced items. |

5-5-1 North Bridge

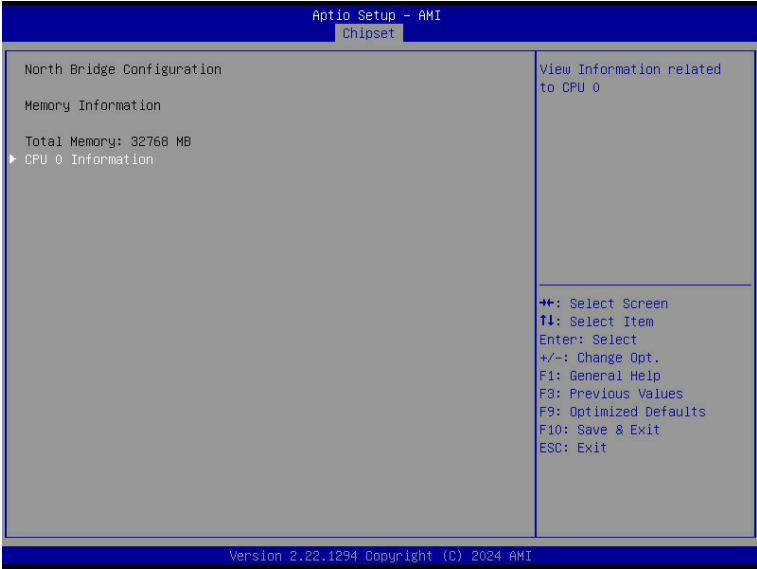

| Parameter | Description |
|----------------------------|---|
| North Bridge Configuration | |
| Memory Information | |
| Total Memory | Displays the total memory information. |
| CPU 0 Information | Press [Enter] to view information related to CPU. |

5-6 Server Management Menu

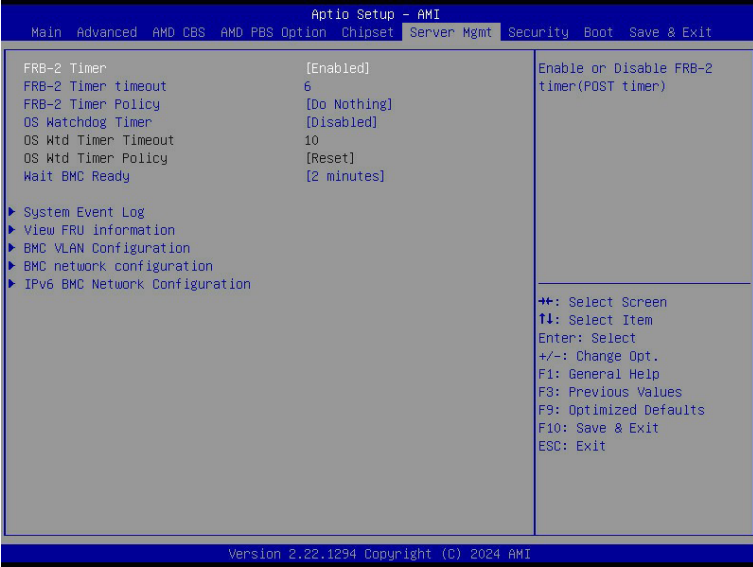

| Parameter | Description |
|--|--|
| FRB-2 Timer | Enable/Disable FRB-2 timer (POST timer). Default setting is Enabled . |
| FRB-2 Timer timeout | Configures the FRB-2 Timer timeout. Default setting is 20 minutes . |
| FRB-2 Timer Policy | Configures the FRB-2 Timer policy. Options available: Do Nothing, Reset, Power Down, Power Cycle. Default setting is Do Nothing . |
| OS Watchdog Timer | Enable/Disable OS Watchdog Timer function. Options available: Enabled, Disabled. Default setting is Disabled . |
| OS Wtd Timer Timeout ^(Note) | Configures OS Watchdog Timer. Options available: 5 minutes, 10 minutes, 15 minutes, 20 minutes. Default setting is 10 minutes . |
| OS Wtd Timer Policy ^(Note) | Configure OS Watchdog Timer Policy. Options available: Do Nothing, Reset, Power Down, Power Cycle. Default setting is Reset . |
| Wait BMC Ready | Post wait BMC ready and reboot system. Options available: Disabled, 2 minutes, 4 minutes, 6 minutes. Default setting is 2 minutes . |

(Note) This item is configurable when **OS Watchdog Timer** is set to **Enabled**.

| Parameter | Description |
|--------------------------------|--|
| System Event Log | Press [Enter] to configure advanced items. |
| View FRU Information | Press [Enter] to view the FRU information. |
| BMC VLAN configuration | Press [Enter] to configure advanced items. |
| BMC network configuration | Press [Enter] to configure advanced items. |
| IPv6 BMC Network Configuration | Press [Enter] to configure advanced items. |

5-6-1 System Event Log

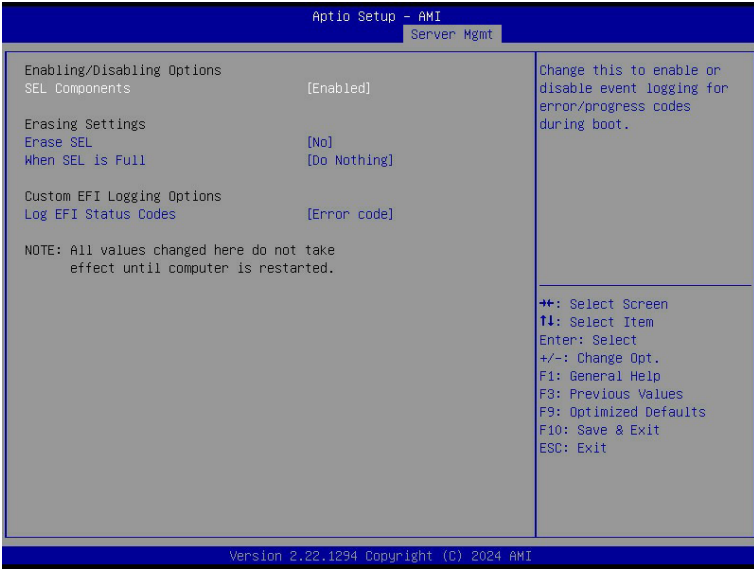

| Parameter | Description |
|------------------------------|--|
| Enabling / Disabling Options | |
| SEL Components | Change this item to enable or disable all features of System Event Logging during boot. Options available: Disabled, Enabled. Default setting is Enabled . |
| Erasing Settings | |
| Erase SEL | Choose options for erasing SEL. Options available: No/Yes, On next reset/Yes, On every reset. Default setting is No . |
| When SEL is Full | Choose options for reactions to a full SEL. Options available: Do Nothing, Erase Immediately. Default setting is Do Nothing . |
| Custom EFI Logging Options | |
| Log EFI Status Codes | Enable/Disable the logging of EFI Status Codes (if not already converted to legacy). Options available: Disabled, Both, Error code, Progress code. Default setting is Error code . |

5-6-2 View FRU Information

The FRU page is a simple display page for basic system ID information, as well as System product information. Items on this window are non-configurable.

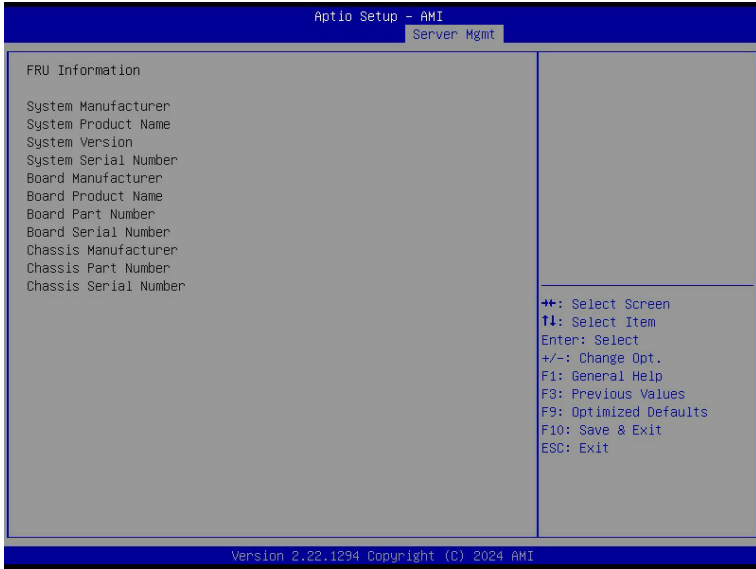

(Note) The model name will vary depends on the product you purchased

5-6-3 BMC VLAN Configuration

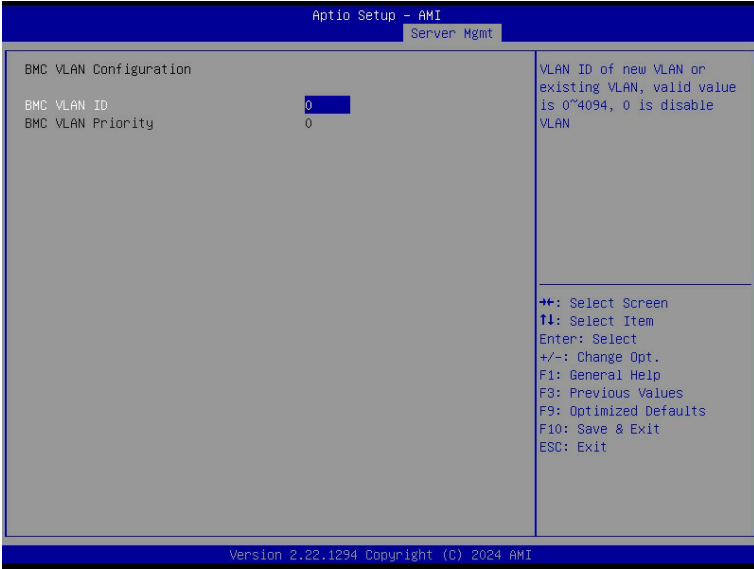

| Parameter | Description |
|------------------------|--|
| BMC VLAN Configuration | |
| BMC VLAN ID | Select to configure BMC VLAN ID. The valid range is from 0 to 4094. When set to 0, BMC VLAN ID will be disabled. |
| BMC VLAN Priority | Select to configure BMC VLAN Priority. The valid range is from 0 to 7. When BMC VLAN ID is set to 0, BMC VLAN Priority will not be selected. |

5-6-4 BMC Network Configuration



| Parameter | Description |
|-----------------------------------|---|
| Select NCSI and Dedicated LAN | Options available: Do Nothing, Mode1 (Dedicated), Mode2 (NCSI), Mode3 (Failover). Default setting is Do Nothing . |
| Lan Channel 1 | |
| Configuration Address source | Selects to configure LAN channel parameters statically or dynamically (DHCP). Do nothing option will not modify any BMC network parameters during BIOS phase. Options available: Unspecified, Static, DynamicBmcDhcp. Default setting is DynamicBmcDhcp . |
| Station IP address | Displays IP Address information. |
| Subnet mask | Displays Subnet Mask information. Please note that the IP address must be in three digitals, for example, 192.168.000.001. |
| Router IP address | Displays the Router IP Address information. |
| Station MAC address | Displays the MAC Address information. |
| VLAN Support | Set BMC to enable/disable VLAN support. Options available: Enabled, Disabled. Default setting is Disabled . |
| Real-time get BMC network address | Press [Enter] will set LAN mode and Address source and then get IP, Subnet, Gateway and MAC address. |

5-6-5 IPv6 BMC Network Configuration

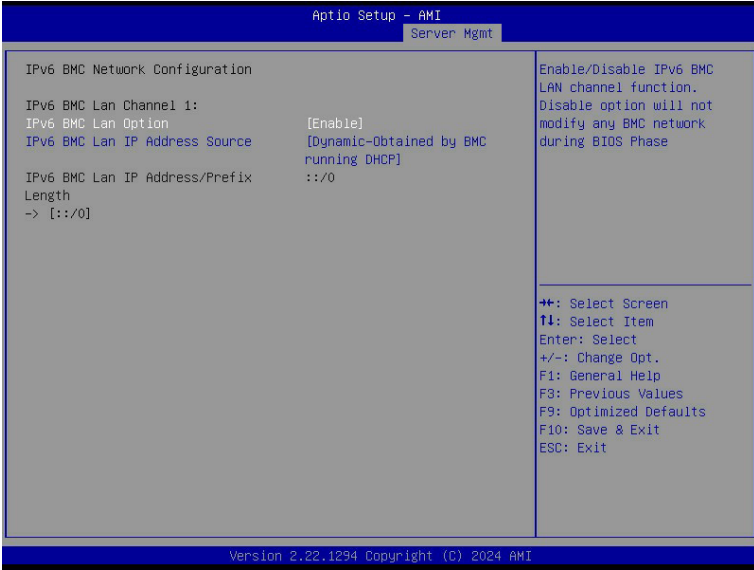

| Parameter | Description |
|---------------------------------------|---|
| IPv6 BMC network configuration | |
| IPv6 BMC Lan Channel 1 | |
| IPv6 BMC Lan Option | Enable/Disable IPv6 BMC LAN channel function. When this item is disabled, the system will not modify any BMC network during BIOS phase. Options available: Unspecified, Disable, Enable. Default setting is Enable . |
| IPv6 BMC Lan IP Address Source | Selects to configure LAN channel parameters statically or dynamically (by BIOS or BMC). Options available: Unspecified, Static, Dynamic-Obtained by BMC running DHCP. Default setting is Dynamic-Obtained by BMC running DHCP . |
| IPv6 BMC Lan IP Address/Prefix Length | Check if the IPv6 BMC LAN IP address matches those displayed on the screen. |

5-7 Security Menu

The Security menu allows you to safeguard and protect the system from unauthorized use by setting up access passwords.

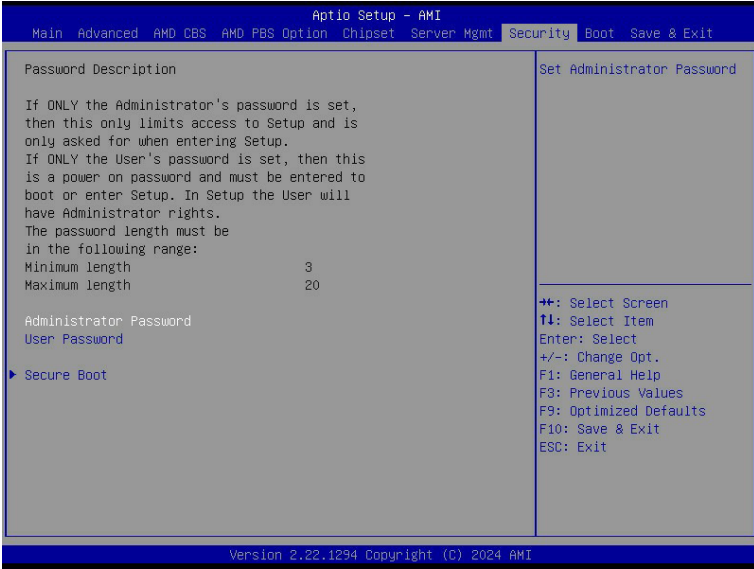

There are two types of passwords that you can set:

- Administrator Password
Entering this password will allow the user to access and change all settings in the Setup Utility.
- User Password
Entering this password will restrict a user's access to the Setup menus. To enable or disable this field, a Administrator Password must first be set. A user can only access and modify the System Time, System Date, and Set User Password fields.

| Parameter | Description |
|------------------------|--|
| Administrator Password | Press [Enter] to configure the administrator password. |
| User Password | Press [Enter] to configure the user password. |
| Secure Boot | Press [Enter] to configure advanced items. |

5-7-1 Secure Boot

The Secure Boot feature is applicable if supported by your Operating System. If your Operating System is not supporting Secure Boot, the system will hang when starting the Operating System.



| Parameter | Description |
|------------------------------------|--|
| System Mode | Displays if the system is in User mode or Setup mode. |
| Secure Boot | Enable/ Disable the Secure Boot function. Options available: Enabled, Disabled. Default setting is Disabled . |
| Secure Boot Mode ^(Note) | Secure Boot requires all the applications that are running during the booting process to be pre-signed with valid digital certificates. This way, the system knows all files being loaded before the Operating System loads to the login screen have not been tampered with. When set to Standard, it will automatically load the Secure Boot keys from the BIOS databases. When set to Custom, you can customize the Secure Boot settings and manually load its keys from the BIOS database. Options available: Standard, Custom. Default setting is Standard . |
| Restore Factory Keys | Forces the system to user mode and installs factory default Secure Boot key database. |
| Reset To Setup Mode | Press [Enter] to reset the system mode to Setup mode. |
| Enter Audit Mode | Press [Enter] to set the system mode to audit mode. |

(Note) Advanced items prompt when this item is set to **Custom**.

| Parameter | Description |
|----------------|--|
| Key Management | <p data-bbox="334 158 666 177">Press [Enter] to configure advanced items.</p> <p data-bbox="334 186 937 236">Please note that this item is configurable when Secure Boot Mode is set to Custom.</p> <ul style="list-style-type: none"> <li data-bbox="334 244 944 349">◆ Factory Key Provision <ul style="list-style-type: none"> <li data-bbox="370 271 944 321">– Allows to provision factory default Secure Boot keys when system is in Setup Mode. <li data-bbox="370 327 905 349">– Options available: Enabled, Disabled. Default setting is Disabled. <li data-bbox="334 355 926 431">◆ Restore Factory Keys <ul style="list-style-type: none"> <li data-bbox="370 382 926 404">– Installs all factory default keys. It will force the system in User Mode. <li data-bbox="370 410 604 431">– Options available: Yes, No. <li data-bbox="334 437 902 512">◆ Enroll Efi Image <ul style="list-style-type: none"> <li data-bbox="370 464 902 512">– Press [Enter] to enroll SHA256 hash of the binary into Authorized Signature Database (db). <li data-bbox="334 519 898 569">◆ Secure Boot variable <ul style="list-style-type: none"> <li data-bbox="370 545 898 569">– Displays the current status of the variables used for secure boot. <li data-bbox="334 575 802 680">◆ Platform Key (PK) <ul style="list-style-type: none"> <li data-bbox="370 602 802 624">– Displays the current status of the Platform Key (PK). <li data-bbox="370 630 678 652">– Press [Enter] to configure a new PK. <li data-bbox="370 658 602 680">– Options available: Update. <li data-bbox="334 686 942 824">◆ Key Exchange Keys (KEK) <ul style="list-style-type: none"> <li data-bbox="370 713 942 735">– Displays the current status of the Key Exchange Key Database (KEK). <li data-bbox="370 741 905 791">– Press [Enter] to configure a new KEK or load additional KEK from storage devices. <li data-bbox="370 798 671 820">– Options available: Update, Append. <li data-bbox="334 826 948 964">◆ Authorized Signatures (DB) <ul style="list-style-type: none"> <li data-bbox="370 852 905 874">– Displays the current status of the Authorized Signature Database. <li data-bbox="370 881 948 931">– Press [Enter] to configure a new DB or load additional DB from storage devices. <li data-bbox="370 937 671 959">– Options available: Update, Append. <li data-bbox="334 965 902 1103">◆ Forbidden Signatures (DBX) <ul style="list-style-type: none"> <li data-bbox="370 992 902 1014">– Displays the current status of the Forbidden Signature Database. <li data-bbox="370 1020 891 1070">– Press [Enter] to configure a new dbx or load additional dbx from storage devices. <li data-bbox="370 1077 671 1099">– Options available: Update, Append. <li data-bbox="334 1105 929 1243">◆ Authorized TimeStamps (DBT) <ul style="list-style-type: none"> <li data-bbox="370 1132 929 1154">– Displays the current status of the Authorized TimeStamps Database. <li data-bbox="370 1160 905 1210">– Press [Enter] to configure a new DBT or load additional DBT from storage devices. <li data-bbox="370 1216 671 1238">– Options available: Update, Append. <li data-bbox="334 1244 919 1382">◆ OsRecovery Signatures <ul style="list-style-type: none"> <li data-bbox="370 1271 919 1293">– Displays the current status of the OsRecovery Signature Database. <li data-bbox="370 1299 887 1350">– Press [Enter] to configure a new OsRecovery Signature or load additional OsRecovery Signature from storage devices. <li data-bbox="370 1356 671 1378">– Options available: Update, Append. |

5-8 Boot Menu

The Boot menu allows you to set the drive priority during system boot-up. BIOS setup will display an error message if the legacy drive(s) specified is not bootable.

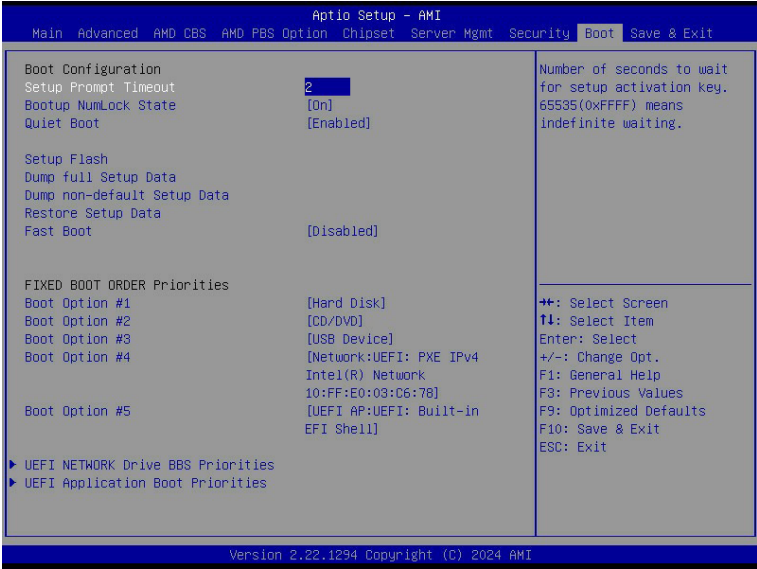

| Parameter | Description |
|-----------------------------|---|
| Boot Configuration | |
| Setup Prompt Timeout | Number of seconds to wait for setup activation key. 65535 (0xFFFF) means indefinite waiting. Press the numeric keys to input the desired values. |
| Bootup NumLock State | Enable/Disable the Bootup NumLock function. Options available: On, Off. Default setting is On . |
| Quiet Boot | Enable/Disable showing the logo during POST. Options available: Enabled, Disabled. Default setting is Enabled . |
| Setup Flash | Press [Enter] to run setup flash. |
| Dump full Setup Data | Press [Enter] to dump full setup data to file. |
| Dump non-default Setup Data | Press [Enter] to dump non-default setup data to file. |
| Restore Setup Data | Press [Enter] to restore setup data from file (cJson format). |
| Fast Boot | Options available: Disabled, Enabled. Default setting is Disabled . |

| Parameter | Description |
|------------------------------------|---|
| FIXED BOOT ORDER Priorities | |
| Boot Option #1 / #2 / #3 / #4 / #5 | <p>Press [Enter] to configure the boot priority. By default, the server searches for boot devices in the following sequence:</p> <ol style="list-style-type: none"> 1. Hard drive. 2. CD-COM/DVD drive. 3. USB device. 4. Network. 5. UEFI. |
| UEFI NETWORK Drive BBS Priorities | Press [Enter] to configure the boot priority. |
| UEFI Application Boot Priorities | Press [Enter] to configure the boot priority. |

5-9 Save & Exit Menu

The Save & Exit menu displays the various options to quit from the BIOS setup. Highlight any of the exit options then press <Enter>.

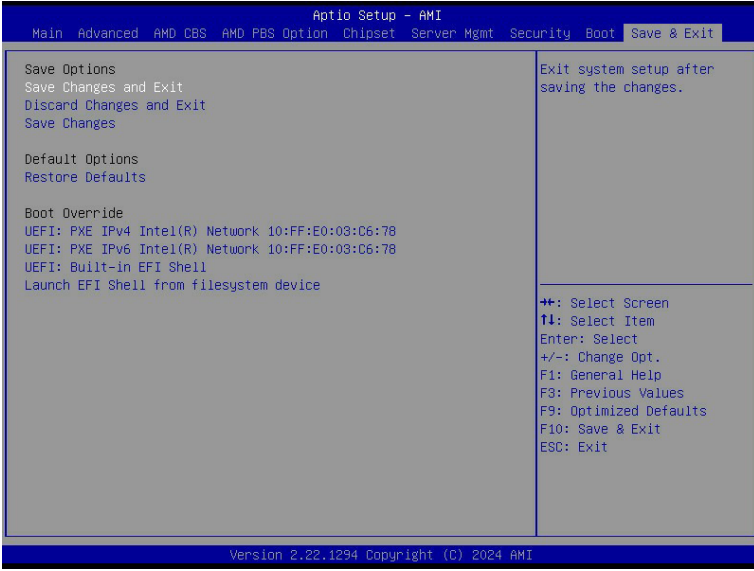

| Parameter | Description |
|---|--|
| Save Options | |
| Save Changes and Exit | Saves changes made and closes the BIOS setup. Options available: Yes, No. |
| Discard Changes and Exit | Discards changes made and exits the BIOS setup. Options available: Yes, No. |
| Save Changes | Saves changes done so far to any of the setup options. Options available: Yes, No. |
| Default Options | |
| Restore Defaults | Loads the default settings for all BIOS setup parameters. Setup Defaults are quite demanding in terms of resources consumption. If you are using low-speed memory chips or other kinds of low-performance components and you choose to load these settings, the system might not function properly. Options available: Yes, No. |
| Boot Override | Press [Enter] to configure the device as the boot-up drive. |
| Launch EFI Shell from filesystem device | Attempts to Launch EFI Shell application (Shell.efi) from one of the available file system devices. |

5-10 BIOS Recovery

The system has an embedded recovery technique. In the event that the BIOS becomes corrupt the boot block can be used to restore the BIOS to a working state. To restore your BIOS, please follow the instructions listed below:

Recovery Instruction:

1. Copy the XXX.rom to USB diskette.
2. Setting BIOS Recovery jump to enabled status.
3. Boot into BIOS recovery.
4. Run Proceed with flash update.
5. BIOS updated.

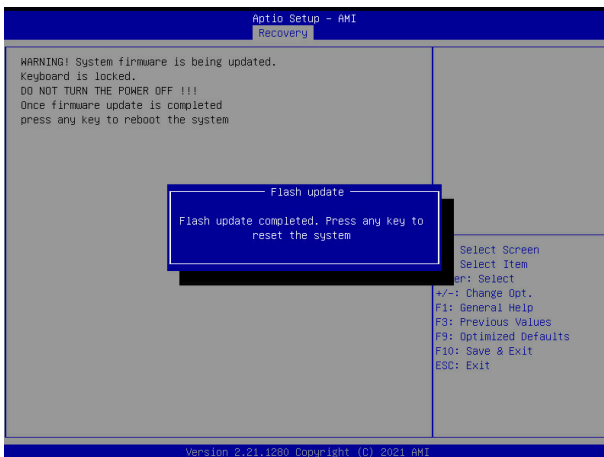
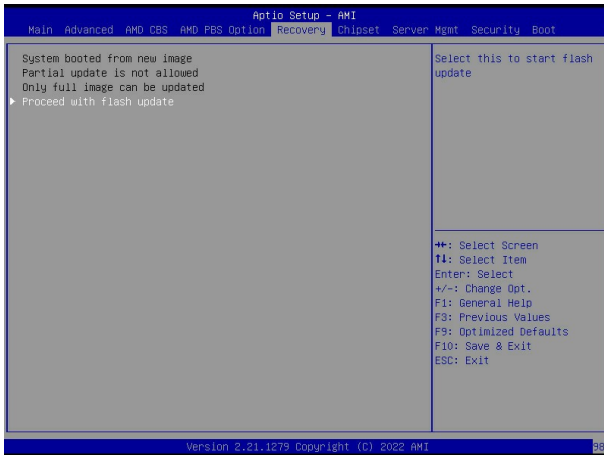

5-11 BIOS POST Beep code (AMI standard)

5-11-1 PEI Beep Codes

| # of Beeps | Description |
|------------|--|
| 1 | Memory not Installed. |
| 1 | Memory was installed twice (InstallPeiMemory routine in PEI Core called twice) |
| 2 | Recovery started |
| 3 | DXE IPL was not found |
| 3 | DXE Core Firmware Volume was not found |
| 4 | Recovery failed |
| 4 | S3 Resume failed |
| 7 | Reset PPI is not available |

5-11-2 DXE Beep Codes

| # of Beeps | Description |
|------------|---|
| 1 | Invalid password |
| 4 | Some of the Architectural Protocols are not available |
| 5 | No Console Output Devices are found |
| 5 | No Console Input Devices are found |
| 6 | Flash update is failed |
| 7 | Reset protocol is not available |
| 8 | Platform PCI resource requirements cannot be met |