

# **GIGABYTE™**

# **R163-P30-AAG1**

Rack Arm Server - AmpereOne® Family  
1U UP 4-Bay Gen5 NVMe/SATA/SAS-4

## **User Manual**

Rev. 1.0

## **Copyright**

© 2024 Giga Computing Technology CO., LTD. All rights reserved.

The trademarks mentioned in this manual are legally registered to their respective owners.

## **Disclaimer**

Information in this manual is protected by copyright laws and is the property of Giga Computing. Changes to the specifications and features in this manual may be made by Giga Computing without prior notice. No part of this manual may be reproduced, copied, translated, transmitted, or published in any form or by any means without Giga Computing's prior written permission.

## **Documentation Classifications**

In order to assist in the use of this product, Giga Computing provides the following types of documentation:

- User Manual: detailed information & steps about the installation, configuration and use of this product (e.g. motherboard, server barebones), covering hardware and BIOS.
- User Guide: detailed information about the installation & use of an add-on hardware or software component (e.g. BMC firmware, rail-kit) compatible with this product.
- Quick Installation Guide: a short guide with visual diagrams that you can reference easily for installation purposes of this product (e.g. motherboard, server barebones).

Please see the support section of the online product page to check the current availability of these documents.

## **For More Information**

For related product specifications, the latest firmware and software, and other information please visit our website at <http://www.gigabyte.com/Enterprise>



For GIGABYTE distributors and resellers, additional sales & marketing materials are available from our reseller portal: <http://reseller.b2b.gigabyte.com>

For further technical assistance, please contact your GIGABYTE representative or visit <https://support.gigabyte.com/> to create a new support ticket

For any general sales or marketing enquiries, you may also message GIGABYTE server directly by email: [server.grp@gigabyte.com](mailto:server.grp@gigabyte.com)

## Conventions

The following conventions are used in this user's guide:

	<b>NOTE!</b> Pieces of additional information related to the current topic.
	<b>CAUTION!</b> Precautionary measures to avoid possible hardware or software problems.
	<b>WARNING!</b> Alerts to any damage that might result from doing or not doing specific actions.

## Server Warnings and Cautions

Before installing a server, be sure that you understand the following warnings and cautions.



### **WARNING!**

#### **To reduce the risk of electric shock or damage to the equipment:**

- Do not disable the power cord grounding plug. The grounding plug is an important safety feature.
- Plug the power cord into a grounded (earthed) electrical outlet that is easily accessible at all times.
- Unplug the power cord from the power supply to disconnect power to the equipment.
- Do not route the power cord where it can be walked on or pinched by items placed against it. Pay particular attention to the plug, electrical outlet, and the point where the cord extends from the server.



### **WARNING!**

**To reduce the risk of personal injury from hot surfaces, allow the drives and the internal system components to cool before touching them.**



### **WARNING!**

**This server is equipped with high speed fans. Keep away from hazardous moving fan blades during servicing.**



### **WARNING!**

**The equipment should only be repaired, maintained or replaced by skilled personnel.**



### **CAUTION!**

- Do not operate the server for long periods with the access panel open or removed. Operating the server in this manner results in improper airflow and improper cooling that can lead to thermal damage.
- Danger of explosion if battery is incorrectly replaced.
- Replace battery with the same or equivalent type recommended by the manufacturer.
- Dispose of used batteries according to the manufacturer's instructions.



### **CAUTION!**

Risk of explosion if battery is replaced incorrectly or with an incorrect type. Replace the battery only with the same or equivalent type recommended by the manufacturer. Dispose of used batteries according to the manufacturer's instructions.



## Electrostatic Discharge (ESD)

### CAUTION!

ESD CAN DAMAGE DRIVES, BOARDS, AND OTHER PARTS. WE RECOMMEND THAT YOU PERFORM ALL PROCEDURES AT AN ESD WORKSTATION. IF ONE IS NOT AVAILABLE, PROVIDE SOME ESD PROTECTION BY WEARING AN ANTI-STATIC WRIST STRAP ATTACHED TO CHASSIS GROUND -- ANY UNPAINTED METAL SURFACE -- ON YOUR SERVER WHEN HANDLING PARTS.

Always handle boards carefully, they can be extremely sensitive to ESD. Hold boards only by their edges without touching any components or connectors. After removing a board from its protective ESD bag or from the system, place the board component side up on a grounded, static free surface. Use a conductive foam pad if available but not the ESD bag. Do not slide the board over any surface.

**System power on/off:** To service components within the server, please ensure the power has been disconnected.

e.g. Remove the node from the server chassis (to disconnect power) or disconnect the power from the server chassis.

Make sure the system is removed from the rack before opening the chassis, adding, or removing any non hot-plug components.

**Hazardous conditions, devices and cables:** Hazardous electrical conditions may be present on power, telephone, and communication cables. Turn off the system chassis and disconnect the cables attached to the system before servicing the chassis. Otherwise, personal injury or equipment damage can result.

**Electrostatic discharge (ESD) and ESD protection:** ESD can damage drives, boards, and other parts. We recommend that you perform all procedures in this chapter only at an ESD workstation. If one is not available, provide some ESD protection by wearing an antistatic wrist strap attached to chassis ground (any unpainted metal surface on the server) when handling parts.

**ESD and handling boards:** Always handle boards carefully. They can be extremely sensitive to electrostatic discharge (ESD). Hold boards only by their edges. After removing a board from its protective wrapper or from the system, place the board component side up on a grounded, static free surface. Use a conductive foam pad if available but not the board wrapper. Do not slide board over any surface.

**Installing or removing jumpers:** A jumper is a small plastic encased conductor that slips over two jumper pins. Some jumpers have a small tab on top that can be gripped with fingertips or with a pair of fine needle nosed pliers. If the jumpers do not have such a tab, take care when using needle nosed pliers to remove or install a jumper; grip the narrow sides of the jumper with the pliers, never the wide sides. Gripping the wide sides can damage the contacts inside the jumper, causing intermittent problems with the function controlled by that jumper. Take care to grip with, but not squeeze, the pliers or other tool used to remove a jumper, or the pins on the board may bend or break.

# Table of Contents

Chapter 1 Hardware Installation .....	10
1-1 Installation Precautions .....	10
1-2 Product Specifications .....	11
1-3 System Block Diagram .....	14
Chapter 2 System Appearance .....	15
2-1 Front View .....	15
2-2 Rear View .....	15
2-3 Front Panel LEDs and Buttons .....	16
2-4 RoT LEDs .....	17
2-5 Rear System LAN LEDs .....	19
2-6 Power Supply Unit LED .....	20
2-7 Hard Disk Drive LEDs .....	21
Chapter 3 System Hardware Installation .....	22
3-1 Removing and Installing the Chassis Cover .....	23
3-2 Removing and Installing the Hard Disk Drive .....	24
3-3 Removing and Installing the Fan Duct .....	26
3-4 Removing and Installing the Heat Sink .....	27
3-5 Installing the CPU and Heat Sink .....	28
3-6 Removing and Installing Memory .....	30
3-6-1 Eight Channel Memory Configuration .....	30
3-6-2 Removing and Installing a Memory Module .....	31
3-6-3 DIMM Population Table .....	31
3-6-4 Processor and Memory Module Matrix Table .....	32
3-7 Removing and Installing the PCIe Card .....	33
3-8 Installing the Mezzanine Card .....	34
3-8-1 Installing the OCP 3.0 Mezzanine Card .....	34
3-9 Replacing the Fan Assembly .....	35
3-10 Removing and Installing the Power Supply .....	36
3-11 Cable Routing .....	37
Chapter 4 Motherboard Components .....	42
4-1 Motherboard Components .....	42
4-2 Jumper Settings .....	44
4-3 Backplane Board Storage Connector .....	45
4-3-1 CBP1048 .....	45

Chapter 5 BIOS Setup .....46

- 5-1 The Main Menu ..... 48
- 5-2 Advanced Menu ..... 51
  - 5-2-1 Trusted Computing .....52
  - 5-2-2 S5 RTC Wake Settings .....53
  - 5-2-3 UEFI Variables Protection .....54
  - 5-2-4 Serial Port Console Redirection .....55
  - 5-2-5 PCI Subsystem Settings .....57
  - 5-2-6 Info Report Configuration .....59
  - 5-2-7 USB Configuration .....60
  - 5-2-8 Network Stack Configuration .....61
  - 5-2-9 NVMe Configuration .....62
  - 5-2-10 SATA Configuration.....63
  - 5-2-11 Graphic Output Configuration .....64
  - 5-2-12 Power Restore Configuration .....65
  - 5-2-13 Tls Auth Configuration .....66
  - 5-2-14 Intel(R) i210 Gigabit Network Connection .....67
  - 5-2-15 MAC IPv4 Network Configuration .....69
  - 5-2-16 MAC IPv6 Network Configuration .....70
  - 5-2-17 RAM Disk Configuration .....71
  - 5-2-18 Driver Health.....72
- 5-3 Chipset Menu ..... 73
  - 5-3-1 Memory Configuration .....74
  - 5-3-2 CPU Configuration.....76
  - 5-3-3 ACPI Configuration.....77
  - 5-3-4 PCIE Device Configuration .....78
  - 5-3-5 PCIE Root Complex Configuration .....79
  - 5-3-6 Power Policy.....80
- 5-4 Server Management Menu..... 81
  - 5-4-1 System Event Log .....83
  - 5-4-2 View FRU Information .....84
  - 5-4-3 BMC self test log .....85
  - 5-4-4 BMC VLAN Configuration.....86
  - 5-4-5 BMC Network Configuration .....87
  - 5-4-6 IPv6 BMC Network Configuration .....88
- 5-5 Security Menu ..... 89
  - 5-5-1 Secure Boot .....90
- 5-6 Boot Menu..... 93
- 5-7 Save & Exit Menu.....95
- 5-8 BIOS Recovery ..... 97



5-9 BIOS POST Beep code (AMI standard)..... 98  
5-9-1 PEI Beep Codes .....98  
5-9-2 DXE Beep Codes .....98

# Chapter 1 Hardware Installation

## 1-1 Installation Precautions

The motherboard/system contain numerous delicate electronic circuits and components which can become damaged as a result of electrostatic discharge (ESD). Prior to installation, carefully read the service guide and follow these procedures:

- Prior to installation, do not remove or break motherboard S/N (Serial Number) sticker or warranty sticker provided by your dealer. These stickers are required for warranty validation.
- Always remove the AC power by unplugging the power cord from the power outlet before installing or removing the motherboard or other hardware components.
- When connecting hardware components to the internal connectors on the motherboard, make sure they are connected tightly and securely.
- When handling the motherboard, avoid touching any metal leads or connectors.
- It is best to wear an electrostatic discharge (ESD) wrist strap when handling electronic components such as a motherboard, CPU or memory. If you do not have an ESD wrist strap, keep your hands dry and first touch a metal object to eliminate static electricity.
- Prior to installing the motherboard, please have it on top of an antistatic pad or within an electrostatic shielding container.
- Before unplugging the power supply cable from the motherboard, make sure the power supply has been turned off.
- Before turning on the power, make sure the power supply voltage has been set according to the local voltage standard.
- Before using the product, please verify that all cables and power connectors of your hardware components are connected.
- To prevent damage to the motherboard, do not allow screws to come in contact with the motherboard circuit or its components.
- Make sure there are no leftover screws or metal components placed on the motherboard or within the computer casing.
- Do not place the computer system on an uneven surface.
- Do not place the computer system in a high-temperature environment.
- Turning on the computer power during the installation process can lead to damage to system components as well as physical harm to the user.
- If you are uncertain about any installation steps or have a problem related to the use of the product, please consult a certified computer technician.

# 1-2 Product Specifications



**NOTE:**

We reserve the right to make any changes to the product specifications and product-related information without prior notice.

	System Dimension	<ul style="list-style-type: none"> <li>◆ 1U</li> <li>◆ 438 (W) x 43.5 (H) x 710 (D) mm</li> </ul>
	CPU	<p>AmpereOne® Family Processors</p> <ul style="list-style-type: none"> <li>◆ Up to 192 custom cores</li> <li>◆ Single processor, TDP up to 400W</li> </ul>
	Socket	<ul style="list-style-type: none"> <li>◆ 1 x LGA 5964</li> </ul>
	Chipset	<ul style="list-style-type: none"> <li>◆ System on Chip</li> </ul>
	Memory	<ul style="list-style-type: none"> <li>◆ 16 x DIMM slots</li> <li>◆ DDR5 memory supported only</li> <li>◆ 8-Channel memory architecture</li> <li>◆ RDIMM: Up to 5200 MT/s, 4400 MT/s (2R 2DPC)</li> </ul>
	LAN	<p><b>Rear:</b></p> <p>1 x 1Gb/s LAN (1 x Intel® I210-AT)</p> <ul style="list-style-type: none"> <li>◆ Support NCSI function</li> <li>◆ 1 x 10/100/1000 Mbps Management LAN</li> </ul>
	Video	<ul style="list-style-type: none"> <li>◆ Integrated in Aspeed® AST2600</li> <li>◆ 1 x Mini-DP</li> </ul>
	Storage	<p><b>Front hot-swap:</b></p> <ul style="list-style-type: none"> <li>◆ 4 x 3.5"/2.5" Gen5 NVMe/SATA/<b>SAS-4</b><sup>[1]</sup></li> <li>◆ 8 x 3.5"/2.5" SATA/<b>SAS-4</b><sup>[1]</sup></li> </ul> <p><b>Internal M.2:</b></p> <ul style="list-style-type: none"> <li>◆ 1 x M.2 (2280/22110), PCIe Gen5 x4</li> </ul>
	SAS	<ul style="list-style-type: none"> <li>◆ Require SAS add-in cards</li> </ul>
	RAID	<ul style="list-style-type: none"> <li>◆ Require RAID add-in cards</li> </ul>

**[1] SAS card is required to support SAS drives.**



#### Expansion Slot

##### **Riser Card CRS1010:**

- ◆ 1 x FHHL x16 (Gen5 x16)

##### **Riser Card CRS101P:**

- ◆ 1 x FHHL x16 (Gen5 x16)

2 x OCP NIC 3.0 (Gen5 x16)

Supports NCSI function



#### Front I/O

- ◆ 2 x USB 3.2 Gen1 ports (Type-A)
- ◆ 1 x Power button with LED
- ◆ 1 x ID button with LED
- ◆ 1 x NMI button
- ◆ 1 x Reset button
- ◆ 2 x LAN activity LEDs (1 x LED disabled)
- ◆ 1 x Storage activity LED
- ◆ 1 x System status LED



#### Rear I/O

- ◆ 2 x USB 3.2 Gen1 ports (Type-A)
- ◆ 1 x Mini-DP
- ◆ 1 x RJ45 port
- ◆ 1 x MLAN port
- ◆ 1 x ID button with LED



#### Backplane I/O

- ◆ Speed and bandwidth:
- ◆ PCIe Gen5 x4 or SATA 6Gb/s or SAS-4 24Gb/s



#### Security Modules

- ◆ 1 x TPM header with SPI interface
- ◆ **Optional** TPM2.0 kit: CTM010



## Power Supply

- ◆ 2 x 800W 80 PLUS Titanium redundant power supply

### AC Input:

- ◆ 100-127V ~/ 10A, 50-60Hz
- ◆ 200-240V~/ 5A, 50-60H

### DC Input: (Only for China)

- ◆ 240Vdc/ 5A

### DC Output:

- ◆ Max 800W
- ◆ +12.2V/ 65A
- ◆ +12.2Vsb/ 3A

[Note] GIGABYTE offers PSUs with various efficiency ratings and power outputs. Full redundancy may depend on your server configuration, and alternative PSU options may be needed. Please contact our sales representatives for the best power solution



## System Management

- ◆ Aspeed® AST2600 Baseboard Management Controller
- ◆ GIGABYTE Management Console web interface
- ◆ Dashboard
- ◆ HTML5 KVM
- ◆ Sensor Monitor (Voltage, RPM, Temperature, CPU Status ...etc.)
- ◆ Sensor Reading History Data
- ◆ FRU Information
- ◆ SEL Log in Linear Storage / Circular Storage Policy
- ◆ Hardware Inventory
- ◆ Fan Profile
- ◆ System Firewall
- ◆ Power Consumption
- ◆ Power Control
- ◆ Advanced power capping
- ◆ LDAP / AD / RADIUS Support
- ◆ Backup & Restore Configuration
- ◆ Remote BIOS/BMC/CPLD Update
- ◆ Event Log Filter
- ◆ User Management
- ◆ Media Redirection Settings
- ◆ PAM Order Settings
- ◆ SSL Settings
- ◆ SMTP Settings



## Operating Properties

- ◆ Operating temperature: 10°C to 35°C
- ◆ Operating humidity: 8%-80% (non-condensing)
- ◆ Non-operating temperature: -40°C to 60°C
- ◆ Non-operating humidity: 20%-95% (non-condensing)



## Chapter 2 System Appearance

### 2-1 Front View

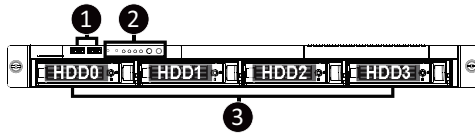

No.	Description
1.	USB 3.2 Gen1 Port
2.	Front Panel LEDs and Buttons
3.	3.5" Drive Bays

**NOTE! The Green Latch Supports NVMe**



- Refer to section 2-3 **Front Panel LEDs and Buttons** for a detailed description of the function of the LEDs.

### 2-2 Rear View

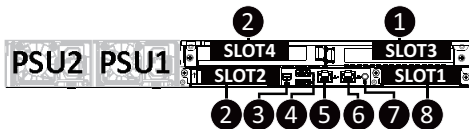

No.	Description	No.	Description
1.	PCIe Slot	5.	Management LAN Port
2.	OCP 3.0 Slot (Option/SFF)	6.	Data LAN Port
3.	Mini DP Port	7.	ID Button with LED
4.	USB 3.2 Gen1 Port x 2	8.	OCP 3.0 Slot (Option/SFF)

## 2-3 Front Panel LEDs and Buttons

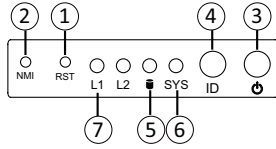

No.	Name	Color	Status	Description
1.	Reset Button			Press the button to reset the system.
2.	NMI button			Press the button server generates a NMI to the processor if the multiple-bit ECC errors occur, which effectively halt the server.
3.	Power button with LED	Green	On	System is powered on
		N/A	Off	<ul style="list-style-type: none"> <li>System is not powered on or in ACPI S5 state (power off)</li> <li>System is in ACPI S4 state (hibernate mode)</li> </ul>
4.	ID Button <sup>(Note)</sup>			Press the button to activate system identification
5.	HDD Status LED	Green	On	HDD locate
			Blink	HDD access
		Amber	On	HDD fault
		Green/Amber	Blink	HDD rebuilding
		N/A	Off	No HDD access or no HDD fault.
6.	System Status LED <sup>(Note)</sup>	Green	Solid On	System is operating normally.
			Solid On	Critical condition, may indicate: System fan failure System temperature
		Amber	Blink	Non-critical condition, may indicate: Redundant power module failure Temperature and voltage issue Chassis intrusion
			N/A	Off
7.	LAN 1 Active/Link LEDs	Green	Solid On	Link between system and network or no access.
		Green	Blink	Data trasmission or receiving is occuring
		N/A	Off	No data transmission or receiving is occuring

(Note) If your server features RoT function, please see the following section for detail LED behavior.



## 2-4 RoT LEDs

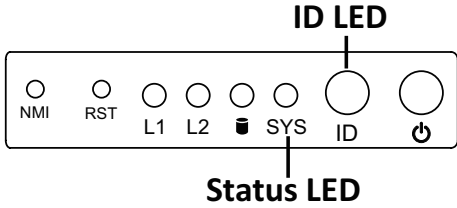

	LED on Front panel <sup>(Note5)</sup>	
	ID LED	Status LED
<b>EC Firmware (FW) Authentication fail or not exit</b>		
EC FW is broken or not exit <sup>(Note1)</sup>	OFF	OFF
<b>Authenticating/Recovering BMC/BIOS Images</b>		
Authenticating Images	OFF	OFF
Recovering BMC Active Flash	Blinks Blue 4 times per second	Blinks Green 4 times per second
Recovering BIOS Active Flash	Blinks Blue 4 times per second	Blinks Green 4 times per second
<b>Authentication (AUTH) Pass</b>		
Recovering BIOS Active Flash	OFF	OFF
BMC : AUTH pass after doing recovery	OFF	OFF
BIOS : AUTH pass after doing recovery	OFF	OFF
BMC : AUTH pass after doing recovery	OFF	OFF
BIOS : AUTH pass	OFF	OFF
BMC : AUTH pass	OFF	OFF
BIOS : AUTH pass after doing recovery	OFF	OFF

<b>Active Flash Authentication (AUTH) Fail</b>		
<b>BMC : AUTH Fail</b> <sup>(Note2)</sup>	Blinks Blue	Blinks Green
	1 time per second	1 time per second
<b>BIOS : AUTH fail</b> <sup>(Note2)</sup>	Blinks Blue	Blinks Amber
	1 time per second	1 time per second
<b>BMC : AUTH fail after doing recovery</b> <sup>(Note3)</sup>	Blinks Blue	Blinks Green
	2 times per second [ON OFF OFF]	2 times per second [ON OFF OFF]
<b>BIOS : AUTH fail after doing recovery</b> <sup>(Note3)</sup>	Blinks Blue	Blinks Amber
	2 times per second [ON OFF OFF]	2 times per second [ON OFF OFF]
<b>Backup Flash Authentication Fail</b> <sup>(Note4)</sup>		
<b>BMC : AUTH fail</b>	Blinks Blue	Blinks Green
	2 times per second [ON OFF ON OFF]	2 times per second [ON OFF ON OFF]
<b>BIOS : AUTH fail</b>	Blinks Blue	Blinks Amber
	2 times per second [ON OFF ON OFF]	2 times per second [ON OFF ON OFF]

**NOTE!**

1. EC FW is broken or not exited result in Microchip CEC1702 cannot load EC FW for authentication.
2. CEC1702's bootloader load EC FW from BMC Flash1 when AC on. It must authenticate this FW firstly before run the FW. If the authenticate fail or not get the FW successfully, CEC1702 is not allowed to execute this FW and ECSTS\_LED1 on the MB is OFF state.
3. If active flash is still authentication failed after recovery sequence, Microchip CEC1702 stop the process and showing LED behavior.
4. If backup flash authentication is failed cause by configuration table, public key or protected area is broken. Microchip CEC1702 stop the process and showing LED behavior.
5. Front panel LED is controlled by BMC or Microchip CEC1702. Once Microchip CEC1702 is working(Auth or recovery), the front panel LED is controlled by Microchip CEC1702 and vice versa.

## 2-5 Rear System LAN LEDs

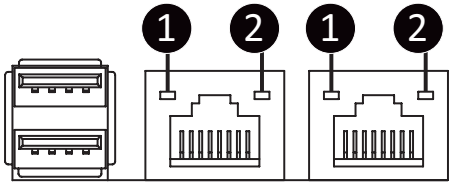

No.	Name	Color	Status	Description
1.	1GbE Speed LED	Yellow	On	1 Gbps data rate
		Green	On	100 Mbps data rate
		N/A	Off	10 Mbps data rate
2.	1GbE Link / Activity LED	Green	On	Link between system and network or no access
			Blink	Data transmission or reception is occurring.
		N/A	Off	No data transmission or reception is occurring.

## 2-6 Power Supply Unit LED

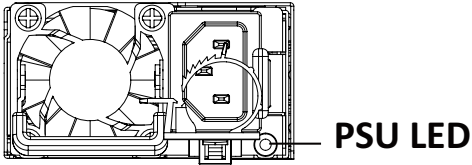

State	Description
OFF	No AC power to all power supplies
1Hz Green Blinking	AC present / only standby on / Cold redundant mode
2Hz Green Blinking	Power supply firmware updateing mode
Amber	AC cord unplugged or AC power lost; with a second power supply in parallel still with AC input power
	Power supply critical event causing shut down: failure, OCP, OVP, fan failure and UVP
1Hz Amber Blinking	Power supply warning events where the power supply continues to operate: high temp, high power, high current and slow fan

## 2-7 Hard Disk Drive LEDs

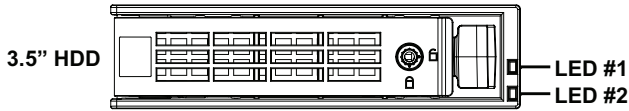

RAID SKU		LED #1	Locate	HDD Fault	Rebuilding	HDD Access	HDD Present (No Access)
No RAID configuration (via HBA)	Disk LED (LED on Back Panel)	Green	ON(*1)	OFF		BLINK (*2)	OFF
		Amber	OFF	OFF		OFF	OFF
	Removed HDD Slot (LED on Back Panel)	Green	ON(*1)	OFF		--	--
		Amber	OFF	OFF		--	--
RAID configuration (via HW RAID Card or SW RAID Card)	Disk LED	Green	ON	OFF		BLINK (*2)	OFF
		Amber	OFF	ON	(Low Speed: 2 Hz)	OFF	OFF
	Removed HDD Slot	Green	ON(*1)	OFF	(*3)	--	--
		Amber	OFF	ON	(*3)	--	--

LED #2	HDD Present	No HDD
Green	ON	OFF

### NOTE:

\*1: Depends on HBA/Utility Spec.

\*2: Blink cycle depends on HDD's activity signal.

\*3: If HDD is pulled out during rebuilding, the disk status of this HDD is regarded as faulty.

## Chapter 3 System Hardware Installation



### Pre-installation Instructions

Computer components and electronic circuit boards can be damaged by discharges of static electricity. Working on computers that are still connected to a power supply can be extremely dangerous. Follow the simple guidelines below to avoid damage to your computer or injury to yourself.

- Always disconnect the computer from the power outlet whenever you are working inside the computer case.
- If possible, wear a grounded wrist strap when you are working inside the computer case. Alternatively, discharge any static electricity by touching the bare metal system of the computer case, or the bare metal body of any other grounded appliance.
- Hold electronic circuit boards by the edges only. Do not touch the components on the board unless it is necessary to do so. Do not flex or stress the circuit board.
- Leave all components inside the static-proof packaging until you are ready to use the component for the installation.

### 3-1 Removing and Installing the Chassis Cover



Before you remove or install the system cover

- Take note of the drive tray orientation before sliding it out.
- The tray will not fit back into the bay if inserted incorrectly.
- Make sure that the HDD is connected to the HDD connector on the backplane.

Follow these instructions to install a 2.5" HDD:

1. Remove the screws on both sides of the back chassis cover.  
**Note: For safe shipping, installation screws are added and should be removed before deployment/putting it in the server cabinet.**
2. Remove the screw securing the back chassis cover.
3. Push button to unlock the handle.
4. Pull the grip handle to open the panel cover.
5. Slide the back chassis cover towards the rear and remove the chassis cover in the direction indicated.
6. Remove the screw securing the middle chassis cover.
7. Slide the middle chassis cover towards the rear and remove the chassis cover in the direction indicated.
8. To reinstall the chassis cover reverse steps 2-7.

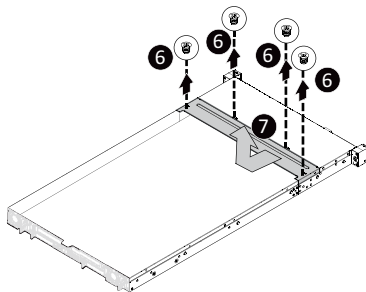
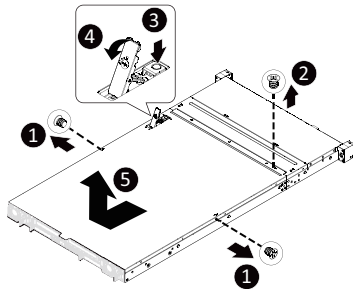

## 3-2 Removing and Installing the Hard Disk Drive



Read the following guidelines before you begin to install the hard disk drive:

- Take note of the HDD tray orientation before sliding it out.
- The tray will not fit back into the bay if it is inserted incorrectly.
- Make sure that the hard disk drive is connected to the connector on the backplane.

**Follow these instructions to install a 3.5" hard disk drive:**

1. Press the release button.
2. Extend the locking lever.
3. Pull the locking lever in the direction indicated to remove the 3.5" HDD tray.
4. Pull the sides of the HDD tray in the direction indicated.
5. Slide the hard disk drive into the HDD tray.
6. Push the sides of the HDD tray back in the direction indicated to secure the hard disk drive in place.
7. Reinsert the HDD tray into the slot and close the locking lever.

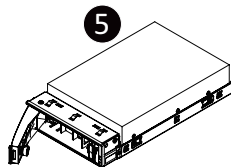
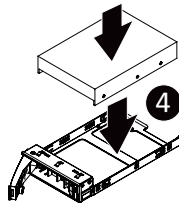
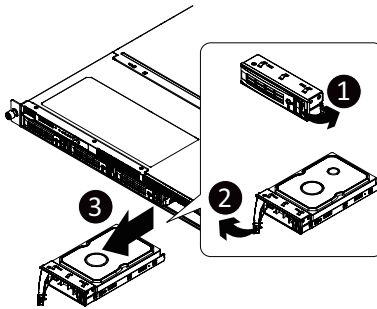



**Follow these instructions to install a 2.5" hard disk drive into 3.5" HDD Tray:**

1. Press the release button.
2. Extend the locking lever.
3. Pull the locking lever in the direction indicated to remove the HDD tray.
4. Align the hard disk drive with the positioning screw on the HDD tray.
5. Secure the hard disk drive with five screws.
6. Reinsert the HDD tray into the slot and close the locking lever

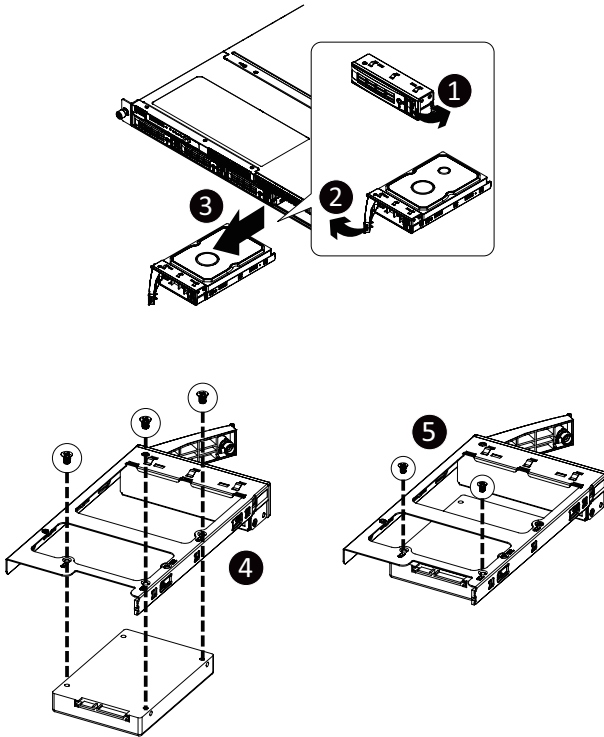

### 3-3 Removing and Installing the Fan Duct

Follow these instructions to remove the fan duct:

1. Lift up to remove the fan duct.
2. To reinstall the fan duct, align the fan duct with the guiding groove. Push down the fan duct until it is firmly seated on the system.

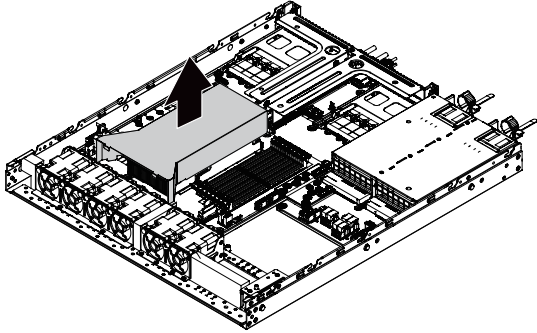

### 3-4 Removing and Installing the Heat Sink



Read the following guidelines before you begin to install the heat sink:

- Always turn off the computer and unplug the power cord from the power outlet before installing the heat sink to prevent hardware damage.
- Unplug all cables from the power outlets.
- Disconnect all telecommunication cables from their ports.
- Place the system unit on a flat and stable surface.
- Open the system according to the instructions.



**WARNING!**

Failure to turn off the server before you start installing components may cause serious damage. Do not attempt the procedures described in the following sections unless you are a qualified service technician.

**Follow these instructions to install the heat sink:**

1. Loosen the screws securing the heat sink in place in reverse order (4→3→2→1).
2. Lift and remove the heat sink from the system.
3. To install the heat sink, reverse steps 1-2 while ensuring that you tighten the captive screws in sequential order (1→2→3→4) as seen in the image below.

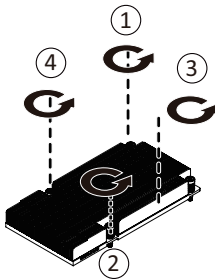

## 3-5 Installing the CPU and Heat Sink



Read the following guidelines before you begin to install the CPU:

- Make sure that the motherboard supports the CPU.
- Always turn off the computer and unplug the power cord from the power outlet before installing the CPU to prevent hardware damage.
- Unplug all cables from the power outlets.
- Disconnect all telecommunication cables from their ports.
- Place the system unit on a flat and stable surface.
- Open the system according to the instructions.



### **WARNING!**

Failure to properly turn off the server before you start installing components may cause serious damage. Do not attempt the procedures described in the following sections unless you are a qualified service technician.

### **Follow these instructions to install the CPU:**

1. Loosen the six captive screws securing the CPU cover in sequential order (1→2→3→4→5→6).
2. Flip open the CPU cover.
3. Remove the plastic covering on the CPU socket
4. Align the processor to the carrier so that the gold triangle on the processor aligns with the triangle on the carrier, and then install the processor into the carrier.

NOTE: Apply thermal compound evenly on the top of the CPU.

5. Install the CPU into place in the CPU socket.

NOTE: Save and replace the CPU socket cover if the processor is removed from its socket.

6. Flip the CPU cover into place over the CPU socket.
7. Tighten the CPU cover screw to secure the CPU cover in place.
8. Secure the heatsink by tightening the screws in sequential order (1→2→3→4).

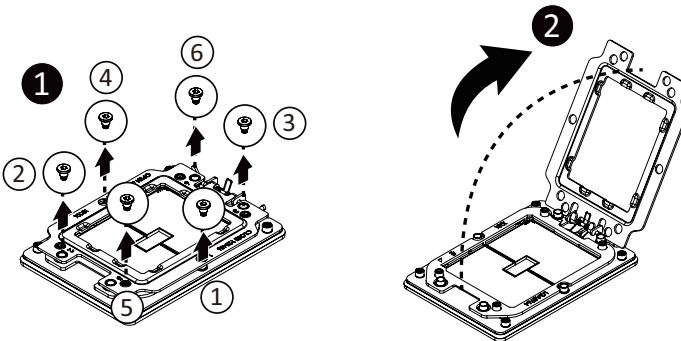

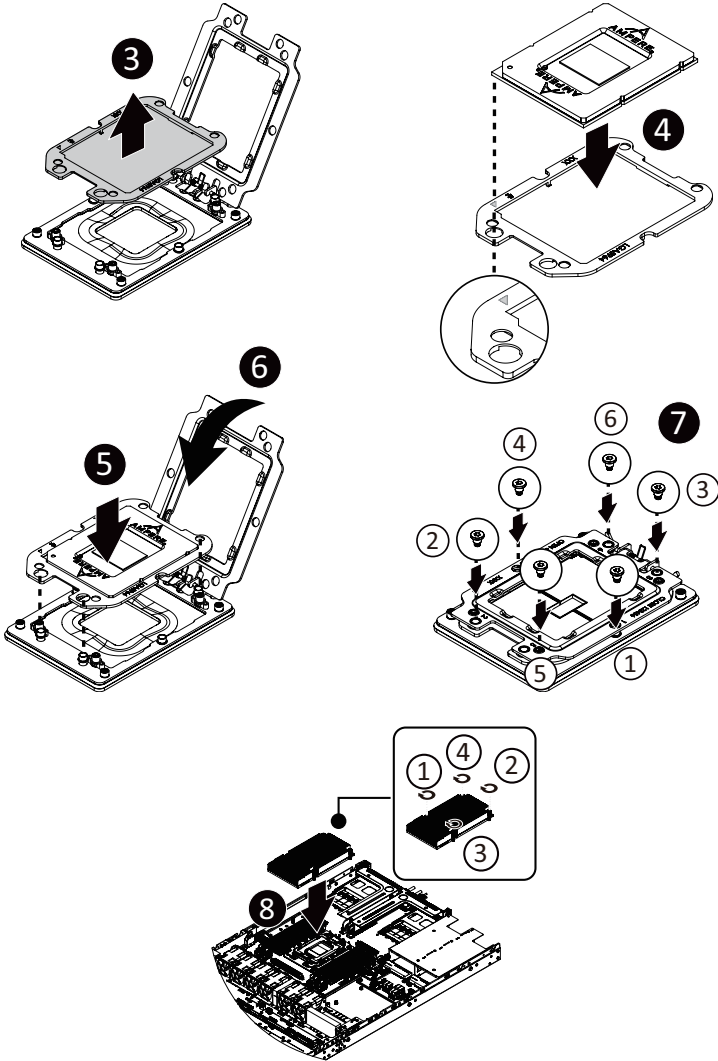

**NOTE!**

- Lock the CPU by using a Torx T20 screwdriver to tighten screw.
- When installing the heatsink to CPU, use Torx T20 screwdriver to tighten 4 captive nuts in sequence as 1-6.
- The ILM screw tightening torque: 1.5 kgf-cm
- The CPU heatsink screw tightening torque: 3 kgf-cm
- ILM and Heat sink for the screw tightening, Tighten the Screw a slight rotations in multiple times until each screw to the desired torque value.
- Do not fully tighten at once screw.

## 3-6 Removing and Installing Memory



Read the following guidelines before you begin to install the memory:

- Make sure that the motherboard supports the memory. It is recommended that memory of the same capacity, brand, speed, and chips be used.
- Always turn off the computer and unplug the power cord from the power outlet before installing the memory to prevent hardware damage.
- Memory modules have a foolproof design. A memory module can be installed in only one direction. If you are unable to insert the memory, switch the direction.

### 3-6-1 Eight Channel Memory Configuration

This motherboard provides 16 DDR5 memory sockets and supports Eight Channel Technology. After the memory is installed, the BIOS will automatically detect the specifications and capacity of the memory.

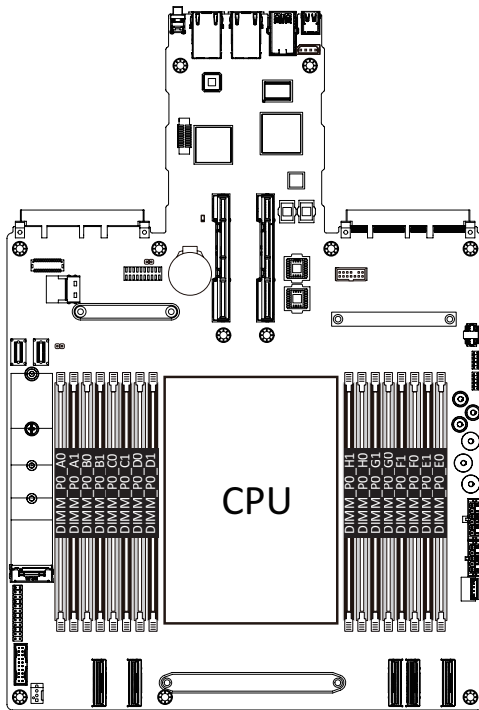

### 3-6-2 Removing and Installing a Memory Module



Before installing a memory module, make sure to turn off the computer and unplug the power cord from the power outlet to prevent damage to the memory module. Be sure to install DDR5 DIMMs on to this motherboard.

Follow these instructions to install a DIMM module:

1. Insert the DIMM memory module vertically into the DIMM slot and push it down.
2. Close the plastic clip at both edges of the DIMM slots to lock the DIMM module.
3. Reverse the installation steps when you want to remove the DIMM module.

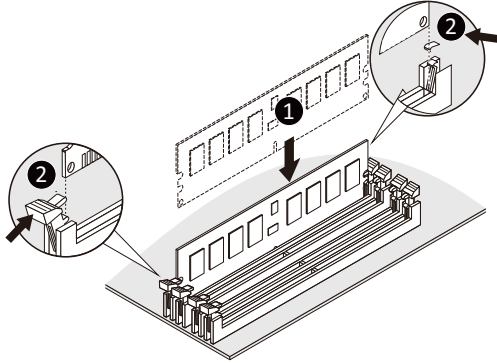

### 3-6-3 DIMM Population Table

Type	Ranks Per DIMM and Data Width	DIMM Capacity (GB)	Speed (MT/s); Voltage (V); Slots per Channel(SPC) and DIMM per Channel (DPC)		
			1 Slot per Channel	2 Slots per Channel	
		DIMM Density	1DPC	1DPC	2DPC
		8Gb	1.2V	1.2V	1.2V
RDIMM	SRx4	16GB	3200	3200	3200
RDIMM	DRx8	16GB			

### 3-6-4 Processor and Memory Module Matrix Table

Memory Q'ty	CPU0																
	A0	A1	B0	B1	C0	C1	D0	D1	H1	H0	G1	G0	F1	F0	E1	E0	
2 DIMM	v																v
4 DIMM	v		v											v			v
8 DIMM	v		v		v		v			v		v		v			v
16 DIMM	v	v	v	v	v	v	v	v	v	v	v	v	v	v	v	v	v



## 3-7 Removing and Installing the PCIe Card



- Voltages can be present within the server whenever an AC power source is connected. This voltage is present even when the main power switch is in the off position. Ensure that the system is powered off and all power sources have been disconnected from the server prior to installing a PCIe card.
- Failure to observe these warnings could result in personal injury or damage to equipment.



- The PCIe riser assembly does not include a riser card or any cabling as standard. To install a PCIe card, a riser card must be installed.

### Follow these instructions to install a PCIe card:

1. Loosen the two thumbnail screws securing the riser bracket inside the system.
2. Lift up the riser bracket out of system.
3. Remove the screw securing the slot cover from riser bracket.
4. Orient the PCIe card with the riser guide slot and push in the direction of the arrow until the PCIe card sits in the PCIe card connector.

**NOTE:** Some riser brackets allow for single or multiple PCIe cards.

Repeat steps 3-4 as necessary.

5. Secure the PCIe card with the screw.
6. Repeat steps 1-2 to install the PCIe card into the system.

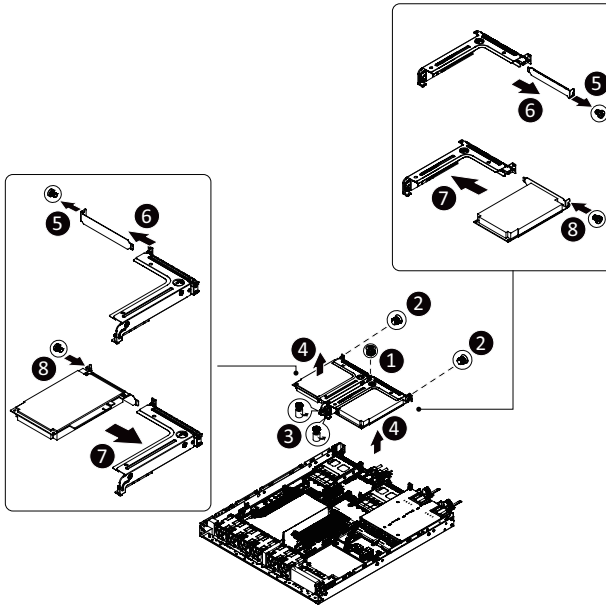

## 3-8 Installing the Mezzanine Card

### 3-8-1 Installing the OCP 3.0 Mezzanine Card



Use of the following type of OCP 3.0 NIC is recommended:

- OCP 3.0 SFF with pull tab
- OCP 3.0 SFF with ejector latch

#### Follow these instructions to install an OCP 3.0 Mezzanine card:

1. Remove the two screws securing the OCP 3.0 card slot cover.
2. Remove the slot cover from the system.
3. Insert the OCP 3.0 card into the card slot ensuring that the card is firmly connected to the connector on the motherboard.
4. Tighten the thumbnail screw to secure the OCP 3.0 card in place.
5. Reverse steps 3-4 to replace the OCP 3.0 card.

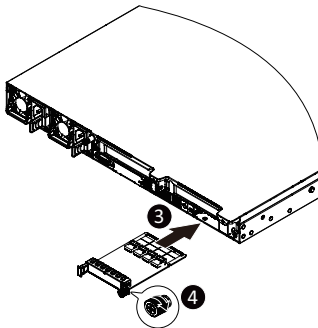
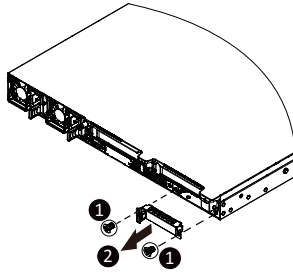

## 3-9 Replacing the Fan Assembly



- Voltages can be present within the server whenever an AC power source is connected. This voltage is present even when the main power switch is in the off position. Ensure that the system is powered-down and all power sources have been disconnected from the server prior to replacing a system fan.

Failure to observe these warnings could result in personal injury or damage to equipment.

### Follow these instructions to replace a fan assembly:

1. Lift up the fan assembly from the chassis.
2. Reverse the previous steps to install the replacement fan assembly

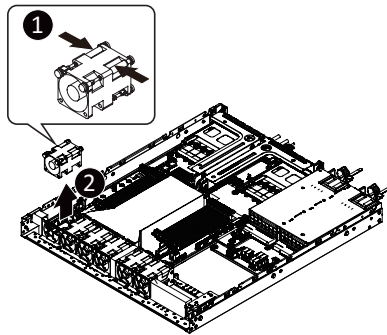

## 3-10 Removing and Installing the Power Supply

Follow these instructions to replace the power supply:

1. Flip up and then grasp the power supply handle.
2. Press the retaining clip on the right side of the power supply unit in the direction indicated.
3. Pull out the power supply unit using the handle.
4. Insert the replacement power supply unit firmly into the chassis. Connect the AC power cord to the replacement power supply.
5. Repeat steps 1-4 for replacement of the second power supply.

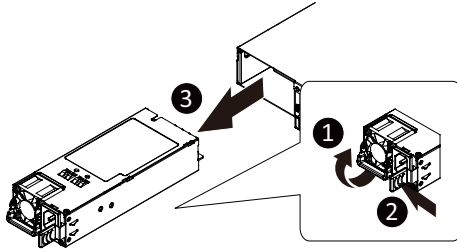

### 3-11 Cable Routing

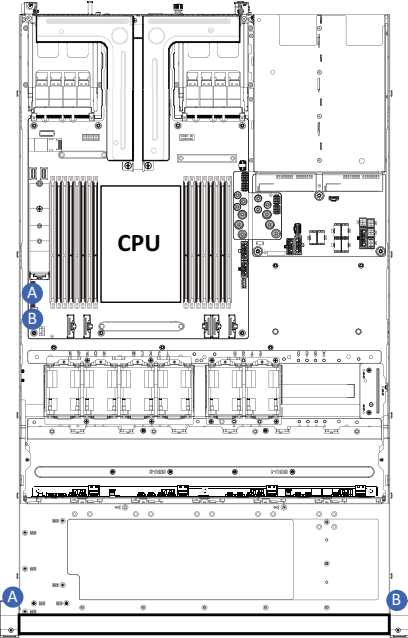

A	Front Panel LEDs and Buttons Cable	Motherboard: FP_1 Front IO Board: FP_1
		Front IO Board: FP_1
B	Front Panel USB 3 Ports Cable	Motherboard: FUSB_1
		--

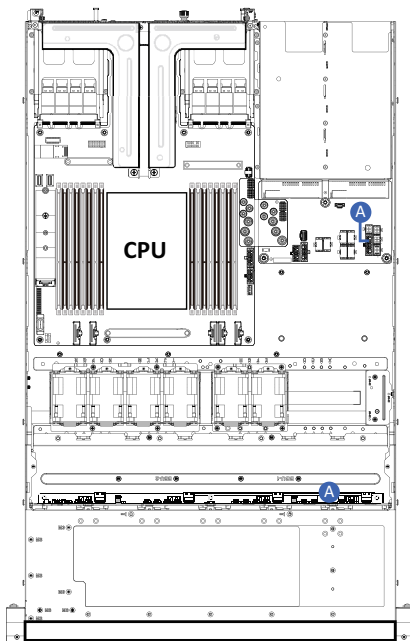

<b>A</b>	HDD Backplane Board Power Cable	Power Board: BP_ATX1
		Front HDD Board: ATX1

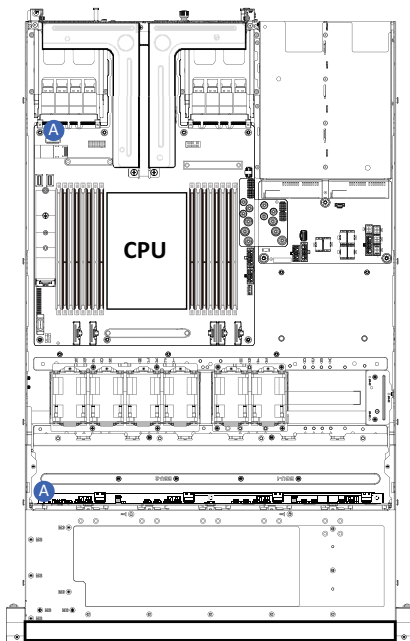

<b>A</b>	HDD Backplane Board Signal Cable	Front HDD Board: BP_1
		Motherboard: BP_1

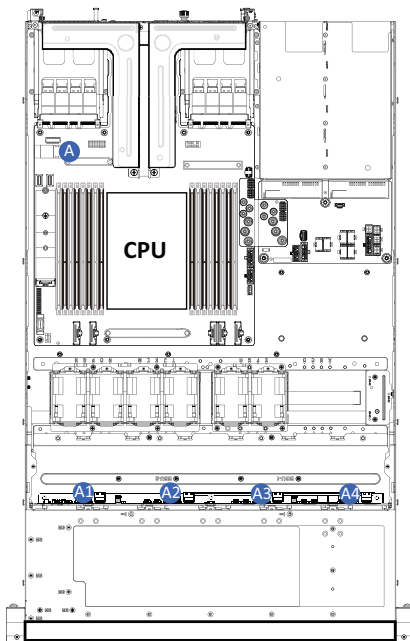

A	SATA Cable	Motherboard: SL_SATA1
		Front HDD Board: A1: SATA0 A2: SATA1 A3: SATA2 A4: SATA3



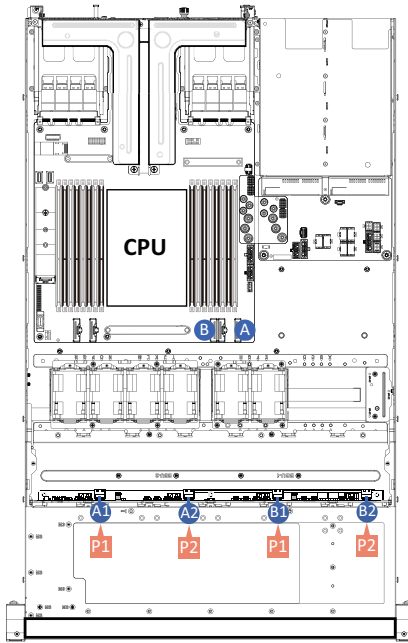

A	NVMe 0-1 Cable	Motherboard: MCIOP0_3AB	B	NVMe 2-3 Cable	Motherboard: MCIOP0_3CD
		Front HDD Board: A1: U.2_0 A2: U.2_1			Front HDD Board: B1: U.2_2 B2: U.2_3

# Chapter 4 Motherboard Components

## 4-1 Motherboard Components

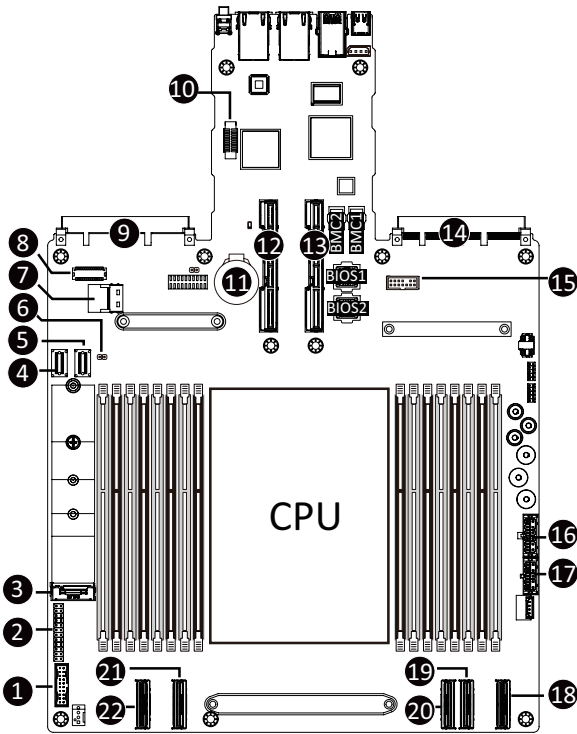

Item	Description
1	Front Panel USB 3.2 Gen1 Connector
2	Front Panel Connector
3	M.2 Slot (PCIe Gen5 x4, support NGFF-2280 or NGFF-22110)
4	SlimLine Connector (SL_SATA3)
5	SlimLine Connector (SL_SATA2)
6	Case Intrusion Alert Connector (Option)
7	SlimLine Connector (SL_SATA1)
8	HDD Back Plane Board Connector
9	OCP 3.0 Connector (PCIe Gen5 x16/OCP1)
10	NCSI Connector for add-on LAN Card (CN_NSCI)
11	System Battery
12	Riser Connector #1 (PCIe Gen5 /x16 Slot)

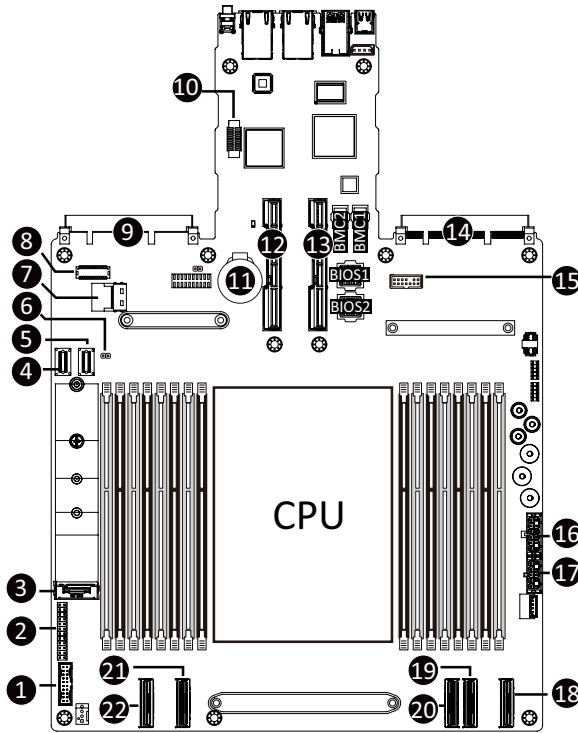

Item	Description
13	Riser Connector #2 (PCIe Gen5 /x16 Slot)
14	OCP 3.0 Connector (PCIe Gen5 x16/OCP2)
15	TPM Module Connector (SPI Interface)
16	2 x 6 Pin ATX Power Connector
17	2 x 5 Pin ATX Power Connector
18	MCI0 Connector (MCIOP0_3AB/PCIe Gen5)
19	MCI0 Connector (MCIOP0_3CD/PCIe Gen5)
20	MCI0 Connector (MCIOP0_5AB/PCIe Gen5)
21	MCI0 Connector (MCIOP0_4CD/PCIe Gen5)
22	MCI0 Connector (MCIOP0_4AB/PCIe Gen5)

# 4-2 Jumper Settings

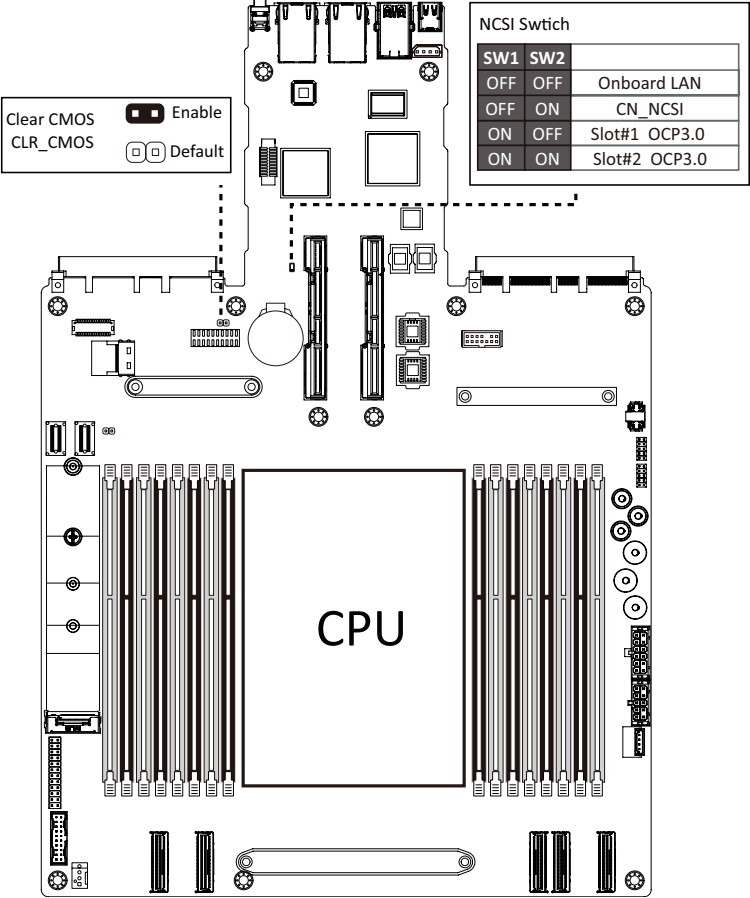

## 4-3 Backplane Board Storage Connector

### 4-3-1 CBP1048

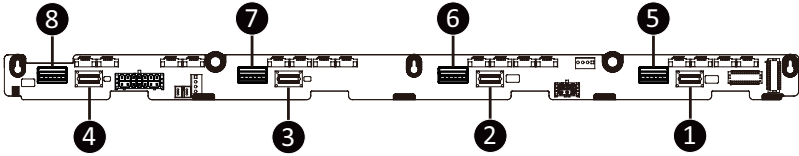

Item	Description
1.	SlimSAS 4i Connector (SFF-8654 / SATA0)
2.	SlimSAS 4i Connector (SFF-8654 / SATA1)
3.	SlimSAS 4i Connector (SFF-8654 / SATA2)
4.	SlimSAS 4i Connector (SFF-8654 / SATA3)
5.	MCIO 4i (SFF-TA-1016 / U.2 0)
6.	MCIO 4i (SFF-TA-1016 / U.2 1)
7.	MCIO 4i (SFF-TA-1016 / U.2 2)
8.	MCIO 4i (SFF-TA-1016 / U.2 3)

## Chapter 5 BIOS Setup

BIOS (Basic Input and Output System) records hardware parameters of the system in the EFI on the motherboard. Its major functions include conducting the Power-On Self-Test (POST) during system startup, saving system parameters, loading the operating system etc. The BIOS includes a BIOS Setup program that allows the user to modify basic system configuration settings or to activate certain system features. When the power is turned off, the battery on the motherboard supplies the necessary power to the CMOS to keep the configuration values in the CMOS.

To access the BIOS Setup program, press the <DEL> key during the POST when the power is turned on.



- BIOS flashing is potentially risky, if you do not encounter any problems when using the current BIOS version, it is recommended that you don't flash the BIOS. To flash the BIOS, do it with caution. Inadequate BIOS flashing may result in system malfunction.
- It is recommended that you not alter the default settings (unless you need to) to prevent system instability or other unexpected results. Inadequately altering the settings may result in system's failure to boot. If this occurs, try to clear the CMOS values and reset the board to default values. (Refer to the **Exit** section in this chapter or introductions of the battery/clearing CMOS jumper in Chapter 4 for how to clear the CMOS values.)

### BIOS Setup Program Function Keys

<<-><->>	Move the selection bar to select the screen
<↑><↓>	Move the selection bar to select an item
<+>	Increase the numeric value or make changes
<->	Decrease the numeric value or make changes
<Enter>	Execute command or enter the submenu
<Esc>	Main Menu: Exit the BIOS Setup program Submenus: Exit current submenu
<F1>	Show descriptions of general help
<F3>	Restore the previous BIOS settings for the current submenus
<F9>	Load the Optimized BIOS default settings for the current submenus
<F10>	Save all the changes and exit the BIOS Setup program

■ **Main**

This setup page includes all the items in standard compatible BIOS.

■ **Advanced**

This setup page includes all the items of AMI BIOS special enhanced features.

(ex: Auto detect fan and temperature status, automatically configure hard disk parameters.)

■ **Chipset**

This setup page includes all the submenu options for configuring the function of processor, network, North Bridge, South Bridge, and System event logs.

■ **Server Management**

Server additional features enabled/disabled setup menus.

■ **Security**

Change, set, or disable supervisor and user password. Configuration supervisor password allows you to restrict access to the system and BIOS Setup.

A supervisor password allows you to make changes in BIOS Setup.

A user password only allows you to view the BIOS settings but not to make changes.

■ **Boot**

This setup page provides items for configuration of boot sequence.

■ **Save & Exit**

Save all the changes made in the BIOS Setup program to the CMOS and exit BIOS Setup. (Pressing <F10> can also carry out this task.)

Abandon all changes and the previous settings remain in effect. Pressing <Y> to the confirmation message will exit BIOS Setup. (Pressing <Esc> can also carry out this task.)

# 5-1 The Main Menu

Once you enter the BIOS Setup program, the Main Menu (as shown below) appears on the screen. Use arrow keys to move among the items and press <Enter> to accept or enter other sub-menu.

## Main Menu Help

The on-screen description of a highlighted setup option is displayed on the bottom line of the Main Menu.

## Submenu Help

While in a submenu, press <F1> to display a help screen (General Help) of function keys available for the menu. Press <Esc> to exit the help screen. Help for each item is in the Item Help block on the right side of the submenu.



- When the system is not stable as usual, select the **Restore Defaults** item to set your system to its defaults.
- The BIOS Setup menus described in this chapter are for reference only and may differ by BIOS version.

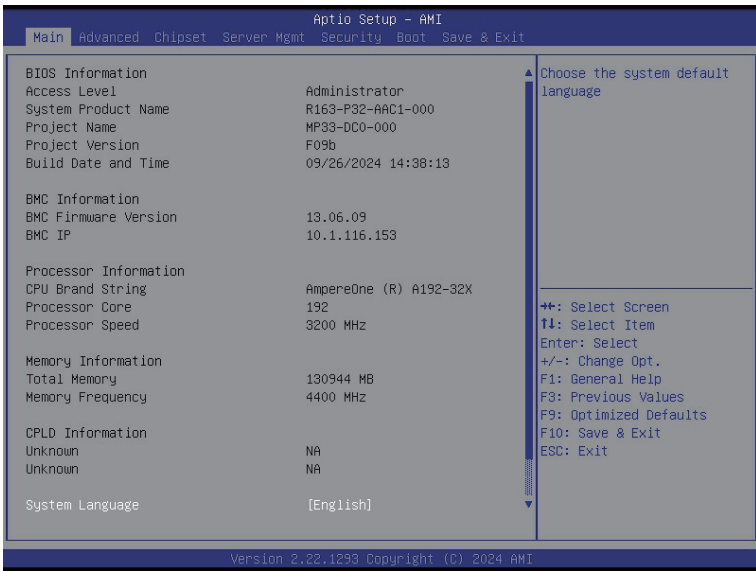



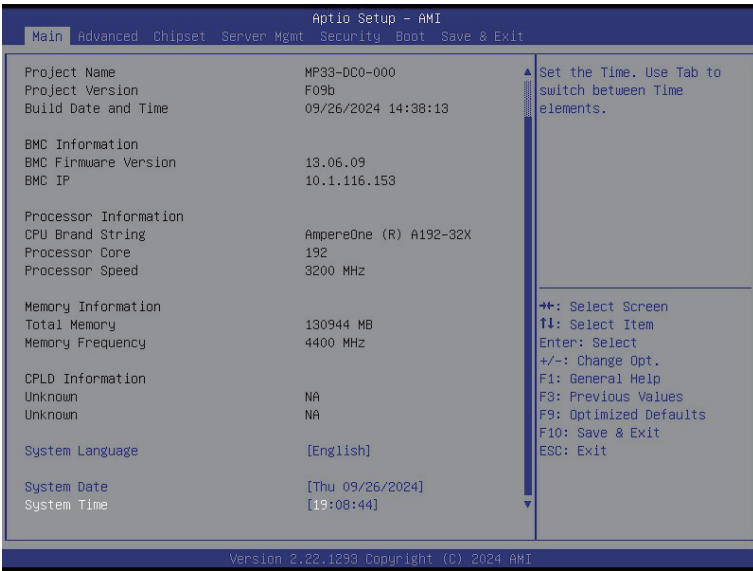

Parameter	Description
<b>BIOS Information</b>	
Access Level	Display the privileges level information.
System Project Name <sup>(Note1)</sup>	Displays the system project name information.
Project Name	Displays the motherboard project name information.
Project Version	Displays version number of the BIOS setup utility.
Build Date and Time	Displays the date and time when the BIOS setup utility was created.
<b>BMC Information</b>	
BMC Firmware Version	Displays version number of the BMC setup utility.
BMC IP	Display the BMC IP information.
<b>Processor Information</b>	
CPU Brand String	
Processor Core	Displays the technical specifications for the installed processor.
Processor Speed	
<b>Memory Information<sup>(Note2)</sup></b>	
Total Memory	
Memory Frequency	Displays the technical specifications for the installed memory.

(Note1) This parameters may vary depends on the product you purchased.

(Note2) This section will display capacity and frequency information of the memory that the customer has installed.

<b>Parameter</b>	<b>Description</b>
CPLD Information	Displays the CPLD information.
System Language	Option: English
System Date	Sets the date following the weekday-month-day-year format.
System Time	Sets the system time following the hour-minute-second format.

## 5-2 Advanced Menu

The Advanced Menu displays submenu options for configuring the function of various hardware components. Select a submenu item, then press <Enter> to access the related submenu screen.

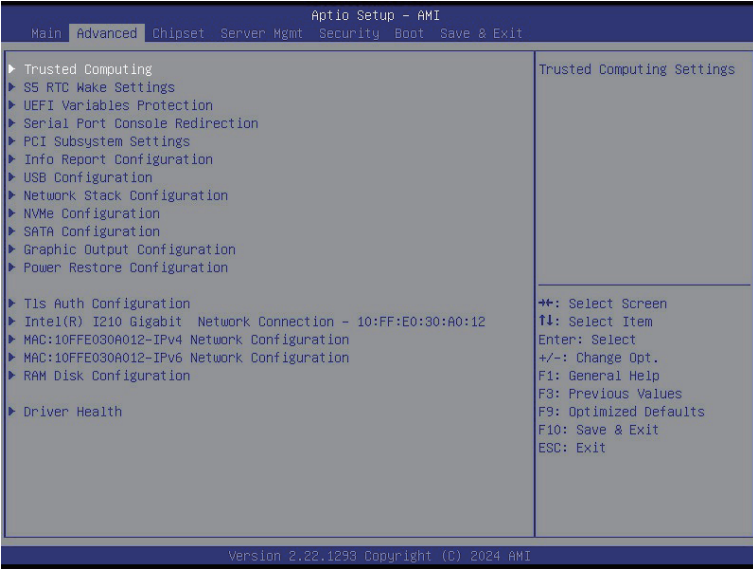

## 5-2-1 Trusted Computing



Parameter	Description
Configuration	
TPM v1.2 Support	<p>Enable/Disable BIOS support for security device. OS will not show security device. TCG EFI protocol and INT1A interface will not be available.</p> <p>Options available: Disable, Enable. Default setting is <b>Enable</b>.</p>

## 5-2-2 S5 RTC Wake Settings



Parameter	Description
Wake System from S5	<p>Enable/Disable system wake on alarm event.</p> <p>Options available: Disabled, Fixed Time, Dynamic Time. When Fixed Time is selected, system will wake on the hr::min::sec specified. Default setting is <b>Disabled</b>.</p>

### 5-2-3 UEFI Variables Protection



Parameter	Description
Password protection of Runtime Variables	Control the NVRAM Runtime Variable protection through system Administrator password. Options available: Enabled, Disabled. Default setting is <b>Enabled</b> .

## 5-2-4 Serial Port Console Redirection

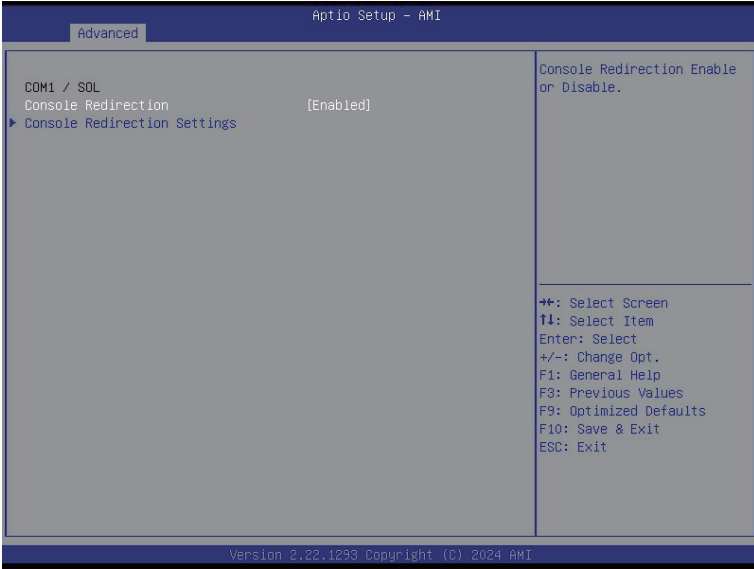

Parameter	Description
COM/SOL	
COM1 Console Redirection <sup>(Note)</sup>	<p>Console redirection enables the users to manage the system from a remote location.</p> <p>Options available: Enabled, Disabled. Default setting is <b>Disabled</b>.</p>
COM1 Console Redirection Settings	<p>Press [Enter] to configure advanced items.</p> <p><b>Please note that this item is configurable when COM1 Console Redirection is set to Enabled.</b></p> <ul style="list-style-type: none"> <li>◆ Terminal Type <ul style="list-style-type: none"> <li>– Selects a terminal type to be used for console redirection.</li> <li>– Options available: VT100, VT100PLUS, VT-UTF8, ANSI. Default setting is <b>VT100PLUS</b>.</li> </ul> </li> <li>◆ Bits per second <ul style="list-style-type: none"> <li>– Selects the transfer rate for console redirection.</li> <li>– Options available: 9600, 19200, 38400, 57600, 115200. Default setting is <b>115200</b>.</li> </ul> </li> <li>◆ Data Bits <ul style="list-style-type: none"> <li>– Selects the number of data bits used for console redirection.</li> <li>– Options available: 7, 8. Default setting is <b>8</b>.</li> </ul> </li> </ul>

(Note) Advanced items prompt when this item is defined.

Parameter	Description
COM1 Console Redirection Settings (continued)	<ul style="list-style-type: none"> <li>◆ Parity <ul style="list-style-type: none"> <li>– A parity bit can be sent with the data bits to detect some transmission errors.</li> <li>– Even: parity bit is 0 if the num of 1's in the data bits is even.</li> <li>– Odd: parity bit is 0 if num of 1's in the data bits is odd.</li> <li>– Mark: parity bit is always 1. Space: Parity bit is always 0.</li> <li>– Mark and Space Parity do not allow for error detection.</li> <li>– Options available: None, Even, Odd, Mark, Space. Default setting is <b>None</b>.</li> </ul> </li> <li>◆ Stop Bits <ul style="list-style-type: none"> <li>– Stop bits indicate the end of a serial data packet. (A start bit indicates the beginning). The standard setting is 1 stop bit. Communication with slow devices may require more than 1 stop bit.</li> <li>– Options available: 1, 2. Default setting is <b>1</b>.</li> </ul> </li> <li>◆ Flow Control <ul style="list-style-type: none"> <li>– Flow control can prevent data loss from buffer overflow. When sending data, if the receiving buffers are full, a 'stop' signal can be sent to stop the data flow. Once the buffers are empty, a 'start' signal can be sent to re-start the flow. Hardware flow control uses two wires to send start/stop signals.</li> <li>– Options available: None, Hardware RTS/CTS. Default setting is <b>None</b>.</li> </ul> </li> <li>◆ VT-UTF8 Combo Key Support <ul style="list-style-type: none"> <li>– Enable/Disable the VT-UTF8 Combo Key Support.</li> <li>– Options available: Enabled, Disabled. Default setting is <b>Enabled</b>.</li> </ul> </li> <li>◆ Recorder Mode <ul style="list-style-type: none"> <li>– When this mode enabled, only texts will be send. This is to capture Terminal data.</li> <li>– Options available: Enabled, Disabled. Default setting is <b>Disabled</b>.</li> </ul> </li> <li>◆ Resolution 100x31 <ul style="list-style-type: none"> <li>– Enable/Disable extended terminal resolution.</li> <li>– Options available: Enabled, Disabled. Default setting is <b>Enabled</b>.</li> </ul> </li> <li>◆ Putty Keypad <ul style="list-style-type: none"> <li>– Selects Function Key and Keypad on Putty.</li> <li>– Options available: VT100, LINUX, XTERMR6, SC0, ESCN, VT400. Default setting is <b>VT100</b>.</li> </ul> </li> </ul>



## 5-2-5 PCI Subsystem Settings

Aptio Setup - AMI

Advanced

PCI Bus Driver Version	A5.01.31	Enable/Disable GEN2_1 I/O ROM.
GEN2_1 I/O ROM	[Enabled]	
GEN2_2 I/O ROM	[Enabled]	
DCP1 I/O ROM	[Enabled]	
DCP2 I/O ROM	[Enabled]	
MCIOPO_3AB I/O ROM	[Enabled]	
MCIOPO_3CD I/O ROM	[Enabled]	
MCIOPO_4AB I/O ROM	[Enabled]	
MCIOPO_4CD I/O ROM	[Enabled]	
MCIOPO_5AB I/O ROM	[Enabled]	
Onboard LAN Controller	[Enabled]	
Onboard LAN1 I/O ROM	[Enabled]	
USB Controller	[Enabled]	
SATA Controller 1	[Enabled]	
SATA Controller 2	[Enabled]	
PCI Devices Common Settings:		
PCI Latency Timer	[32 PCI Bus Clocks]	
VGA Palette Snoop	[Disabled]	
PERR# Generation	[Disabled]	

++: Select Screen  
 ↑↓: Select Item  
 Enter: Select  
 +/-: Change Opt.  
 F1: General Help  
 F8: Previous Values  
 F9: Optimized Defaults  
 F10: Save & Exit  
 ESC: Exit

Version 2.22.1293 Copyright (C) 2024 AMI

Aptio Setup - AMI

Advanced

DCP1 I/O ROM	[Enabled]	If system has SR-IOV capable PCIe Devices, this option Enables or Disables Single Root IO Virtualization Support.
DCP2 I/O ROM	[Enabled]	
MCIOPO_3AB I/O ROM	[Enabled]	
MCIOPO_3CD I/O ROM	[Enabled]	
MCIOPO_4AB I/O ROM	[Enabled]	
MCIOPO_4CD I/O ROM	[Enabled]	
MCIOPO_5AB I/O ROM	[Enabled]	
Onboard LAN Controller	[Enabled]	
Onboard LAN1 I/O ROM	[Enabled]	
USB Controller	[Enabled]	
SATA Controller 1	[Enabled]	
SATA Controller 2	[Enabled]	
PCI Devices Common Settings:		
PCI Latency Timer	[32 PCI Bus Clocks]	
VGA Palette Snoop	[Disabled]	
PERR# Generation	[Disabled]	
SERR# Generation	[Disabled]	
SR-IOV Support	[Enabled]	

++: Select Screen  
 ↑↓: Select Item  
 Enter: Select  
 +/-: Change Opt.  
 F1: General Help  
 F8: Previous Values  
 F9: Optimized Defaults  
 F10: Save & Exit  
 ESC: Exit

Version 2.22.1293 Copyright (C) 2024 AMI

Parameter	Description
PCI Bus Driver Version	Displays the PCI Bus Driver version information.
GENZ_# I/O ROM <sup>(Note1)</sup>	When enabled, this setting will initialize the device expansion ROM for the related PCI-E slot. Options available: Enabled, Disabled. Default setting is <b>Enabled</b> .
OCP_# I/O ROM <sup>(Note2)</sup>	Enable/Disable OCP I/O ROM. Options available: Enabled, Disabled. Default setting is <b>Enabled</b> .
MCIO_# I/O ROM <sup>(Note3)</sup>	Enable/Disable MCIO I/O ROM. Options available: Enabled, Disabled. Default setting is <b>Enabled</b> .
Onboard LAN Controller <sup>(Note4)</sup>	Enable/Disable the LAN devices. Options available: Enabled, Disabled. Default setting is <b>Enabled</b> .
Onboard LAN1 I/O ROM <sup>(Note4)</sup>	Enable/Disable the LAN devices, and initializes device expansion ROM. Options available: Enabled, Disabled. Default setting is <b>Enabled</b> .
Onboard USB Controller	Enable/Disable the USB devices. Options available: Enabled, Disabled. Default setting is <b>Enabled</b> .
Onboard SATA1/2 Controller	Enable/Disable the SATA devices. Options available: Enabled, Disabled. Default setting is <b>Enabled</b> .
PCI Devices Common Settings	
PCI Latency Timer	Value to be programmed onto PCI Latency Timer Register. Options available: 32/64/96/128/160/192/224/248 PCI Bus Clocks. Default setting is <b>32 PCI Bus Clocks</b> .
VGA Palette Snoop	Enable or disable VGA Palette Registers Snooping. Options available: Enabled/Disabled. Default setting is <b>Disabled</b> .
PERR# Generation	Enable or disable PCI device to generate PERR. Options available: Enabled/Disabled. Default setting is <b>Disabled</b> .
SERR# Generation	Enable or disable PCI device to generate SERR. Options available: Enabled/Disabled. Default setting is <b>Disabled</b> .
Re-Size BAR Support	If system has Resizable BAR capable PCIe Devices, this option Enables or Disables Resizable BAR Support. Options available: Enabled, Disabled. Default setting is <b>Disabled</b> .
SR-IOV Support	If the system has SR-IOV capable PCIe devices, this item Enable/Disable Single Root IO Virtualization Support. Options available: Enabled, Disabled. Default setting is <b>Enabled</b> .

(Note1) This section is dependent on the available PCIe Slot.

(Note2) This section is dependent on the available OCP Slot.

(Note3) This section is dependent on the available MCIO connector.

(Note4) This section is dependent on the available LAN controller.

## 5-2-6 Info Report Configuration

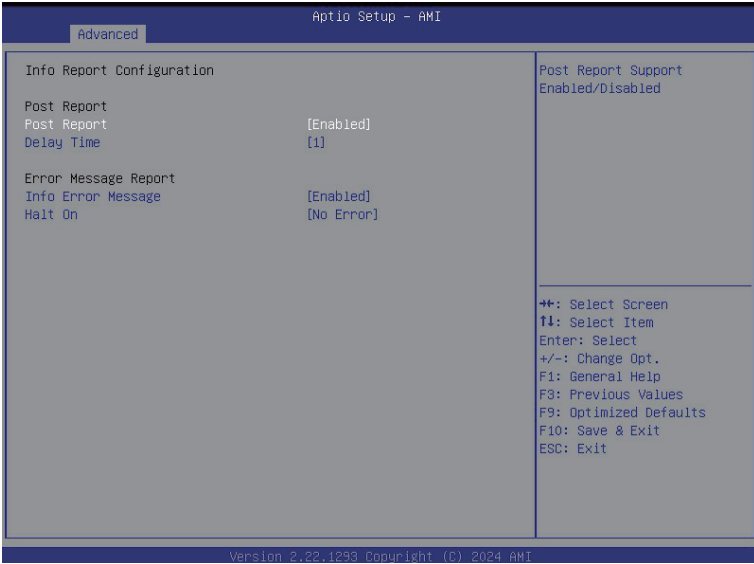

Parameter	Description
Info Report Configuration	
Post Report	
Post Report	Enable/Disable Post Report support. Options available: Enabled/Disabled. Default setting is Enabled.
Delay Time	Options available: 0/1/2/3/4/5/6/7/8/9/10/Util Press ESC. Default setting is 1.
Error Message Report	
Info Error Message	Enable/Disable Info Error Message support. Options available: Enabled/Disabled. Default setting is <b>Enabled</b> .
Halt On	Options available: No Error, All Error. Default setting is <b>No Error</b> .

## 5-2-7 USB Configuration

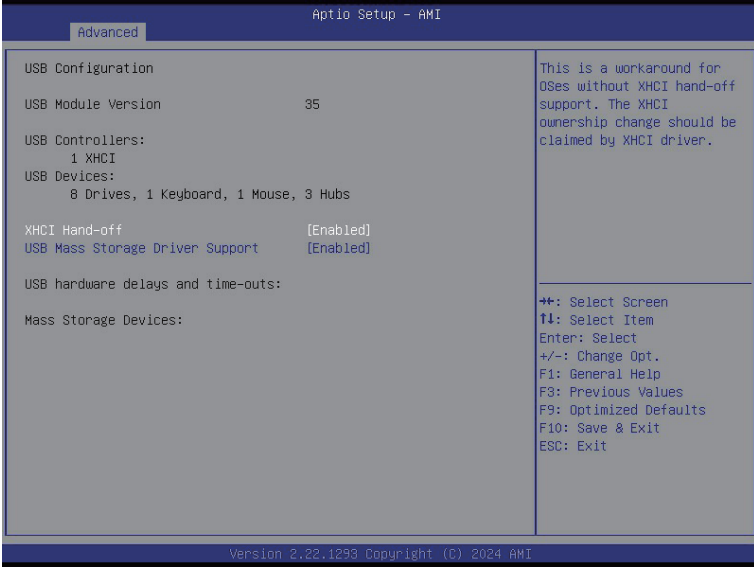

Parameter	Description
USB Configuration	
USB Module Version	Displays USB module version information.
USB Controller	Displays the supported USB controllers.
USB Devices:	Displays the USB devices connected to the system.
XHCI Hand-off	Enable/Disable the XHCI (USB 3.0) Hand-off support. Options available: Enabled/Disabled. Default setting is <b>Enabled</b> .
USB Mass Storage Driver Support <sup>(Note)</sup>	Enable/Disable the USB Mass Storage Driver Support. Options available: Enabled/Disabled. Default setting is <b>Enabled</b> .

(Note) This item is present only if you attach USB devices.

## 5-2-8 Network Stack Configuration



Parameter	Description
Network Stack	Enable/Disable the UEFI network stack. Options available: Enabled, Disabled. Default setting is <b>Enabled</b> .
Ipv4 PXE Support	Enable/Disable the Ipv4 PXE feature. Options available: Enabled, Disabled. Default setting is <b>Enabled</b> .
Ipv4 HTTP Support	Enable/Disable the Ipv4 HTTP feature. Options available: Enabled, Disabled. Default setting is <b>Disabled</b> .
Ipv6 PXE Support	Enable/Disable the Ipv6 PXE feature. Options available: Enabled, Disabled. Default setting is <b>Disabled</b> .
Ipv6 HTTP Support	Enable/Disable the Ipv6 HTTP feature. Options available: Enabled, Disabled. Default setting is <b>Disabled</b> .
PXE boot wait time	Wait time in seconds to press ESC key to abort the PXE boot. Press the <+> / <-> keys to increase or decrease the desired values.
Media detect count	Number of times the presence of media will be checked. Press the <+> / <-> keys to increase or decrease the desired values.

## 5-2-9 NVMe Configuration

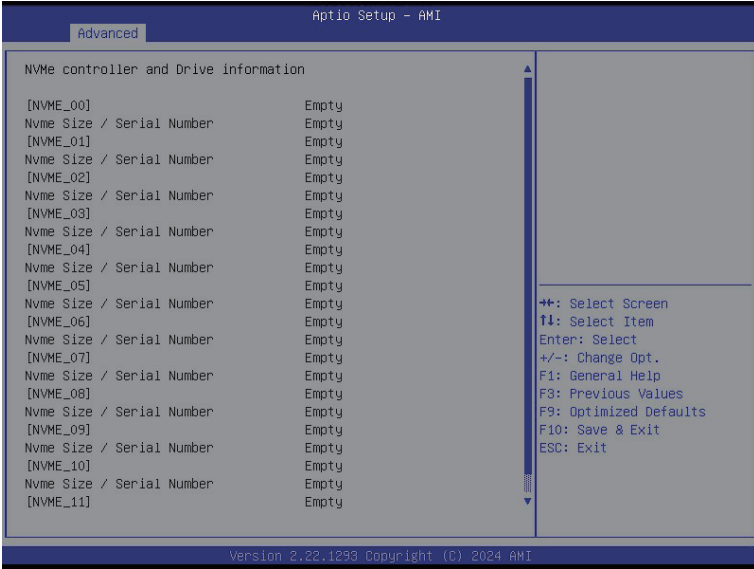

Parameter	Description
NVMe Configuration	Displays the NVMe devices connected to the system.

## 5-2-10 SATA Configuration

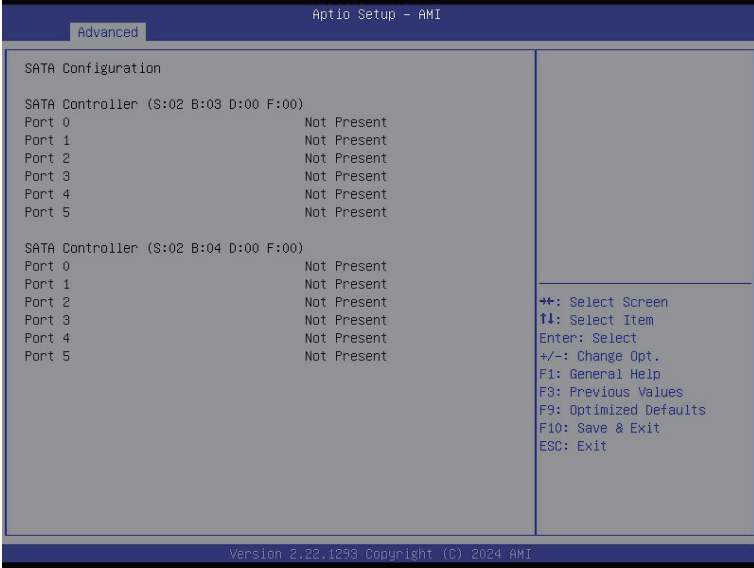

Parameter	Description
SATA Configuration	Displays the installed HDD devices information. System will automatically detect HDD type.

## 5-2-11 Graphic Output Configuration

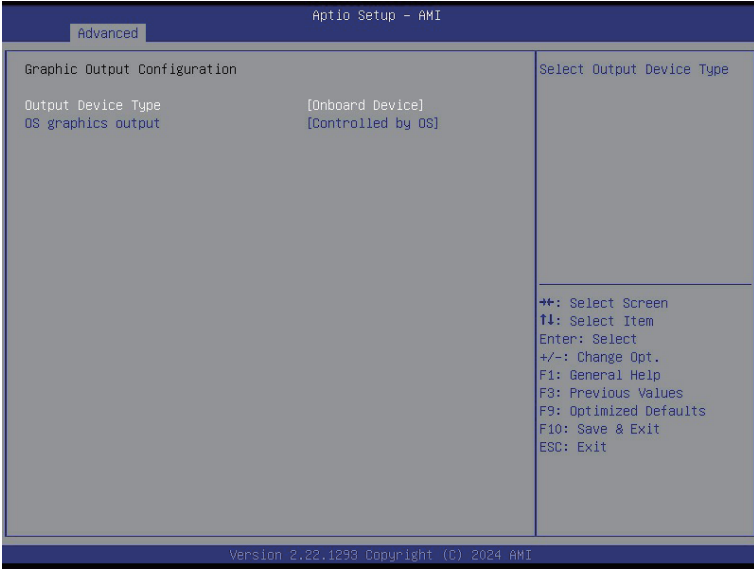

Parameter	Description
Output Device Type	Selects output device type. Options available: First loaded Device, Onboard Device, External Device, Specific Device. Default setting is <b>Onboard Device</b> .
OS graphic output	Default setting is <b>Control by OS</b> .



## 5-2-12 Power Restore Configuration

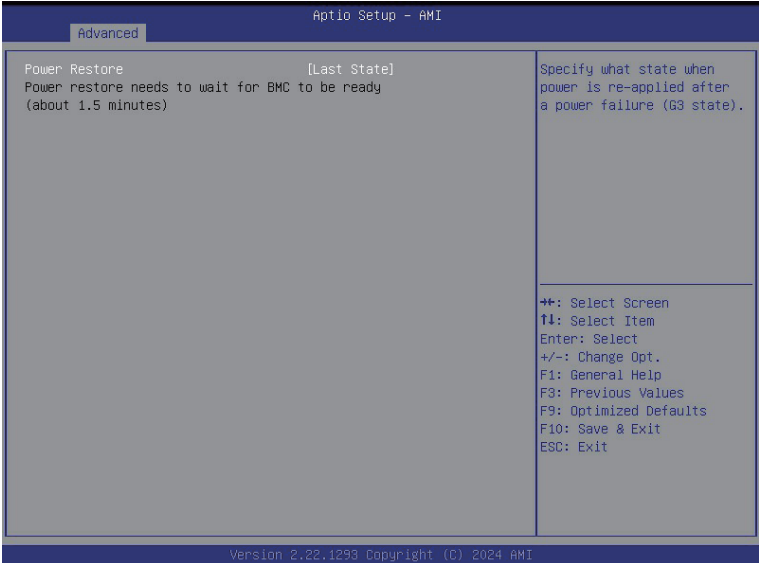

Parameter	Description
Power Restore	Specify what state when power is re-applied after a power failure (G3 state). Options available: Last State/Power On/Power Off. Default setting is <b>Last State</b> .

## 5-2-13 Tls Auth Configuration

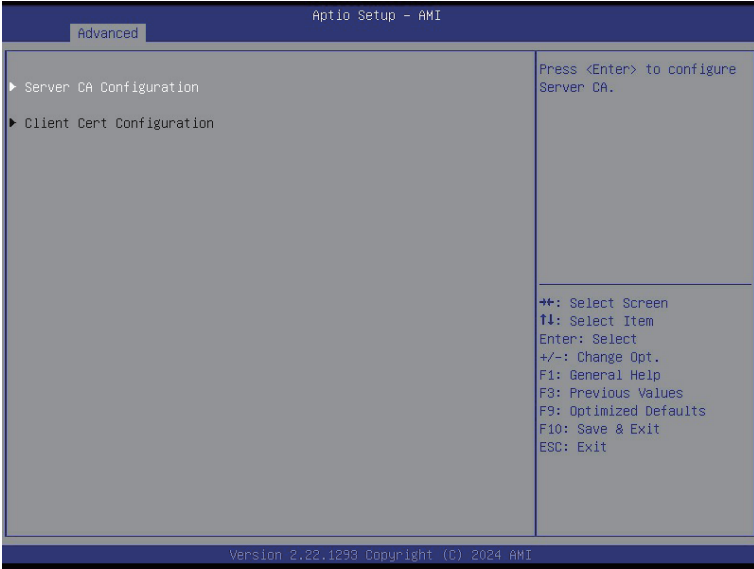

Parameter	Description
Server CA Configuration	<p>Press [Enter] for configuration of advanced items.</p> <ul style="list-style-type: none"> <li>◆ Enroll Cert                             <ul style="list-style-type: none"> <li>– Press [Enter] to enroll a certificate                                     <ul style="list-style-type: none"> <li>• Enroll Cert Using File</li> <li>• Cert GUID   <ul style="list-style-type: none"> <li>Input digit character in 1111111-2222-3333-4444-1234567890ab format.</li> </ul> </li> </ul> </li> <li>– Commit Changes and Exit</li> <li>– Discard Changes and Exit</li> </ul> </li> <li>◆ Delete Cert</li> </ul>
Client Cert Configuration	Press [Enter] for configuration of advanced items.

## 5-2-14 Intel(R) i210 Gigabit Network Connection

Advanced		Aptio Setup - AMI	
<p>▶ NIC Configuration</p> <p>Blink LEDs 0</p> <p>UEFI Driver Intel(R) PRO/1000 Open Source 9.2.06 PCI-E</p> <p>Adapter PBA 000300-000</p> <p>Device Name Intel(R) I210 Gigabit Network Connection</p> <p>Chip Type Intel i210</p> <p>PCI Device ID 1533</p> <p>PCI Address 01:00:00</p> <p>Link Status [Disconnected]</p> <p>MAC Address 10:FF:E0:30:A0:12</p> <p>Virtual MAC Address 00:00:00:00:00:00</p>		<p>Click to configure the network device port.</p>	
		<p>←+: Select Screen</p> <p>↑↓: Select Item</p> <p>Enter: Select</p> <p>+/-: Change Opt.</p> <p>F1: General Help</p> <p>F8: Previous Values</p> <p>F9: Optimized Defaults</p> <p>F10: Save &amp; Exit</p> <p>ESC: Exit</p>	
Version 2.22.1293 Copyright (C) 2024 AMI			

Advanced		Aptio Setup - AMI	
<p>Link Speed [Auto Negotiated]</p> <p>Wake On LAN [Enabled]</p>		<p>Specifies the port speed used for the selected boot protocol.</p>	
		<p>←+: Select Screen</p> <p>↑↓: Select Item</p> <p>Enter: Select</p> <p>+/-: Change Opt.</p> <p>F1: General Help</p> <p>F8: Previous Values</p> <p>F9: Optimized Defaults</p> <p>F10: Save &amp; Exit</p> <p>ESC: Exit</p>	
Version 2.22.1293 Copyright (C) 2024 AMI			

Parameter	Description
NIC Configuration	<p>Press [Enter] to configure advanced items.</p> <ul style="list-style-type: none"> <li>◆ Link Speed <ul style="list-style-type: none"> <li>– Allows for automatic link speed adjustment.</li> <li>– Options available: Auto Negotiated, 10 Mbps Half, 10 Mbps Full, 100 Mbps Half, 100 Mbps Full. Default setting is <b>Auto Negotiated</b>.</li> </ul> </li> <li>◆ Wake On LAN <ul style="list-style-type: none"> <li>– Enables power on of the system via LAN. Note that configuring Wake on LAN in the operating system does not change the value of this setting, but does override the behavior of Wake on LAN in OS controlled power states.</li> <li>– Options available: Enabled, Disabled. Default setting is <b>Enabled</b>.</li> </ul> </li> </ul>
Blink LEDs	<p>Identifies the physical network port by blinking the associated LED. Press the numeric keys to adjust desired values (up to 15 seconds).</p>
UEFI Driver	Displays the technical specifications for the Network Interface Controller.
Adapter PBA	Displays the technical specifications for the Network Interface Controller.
Device Name	Displays the technical specifications for the Network Interface Controller.
Chip Type	Displays the technical specifications for the Network Interface Controller.
PCI Device ID	Displays the technical specifications for the Network Interface Controller.
PCI Address	Displays the technical specifications for the Network Interface Controller.
Link Status	Displays the technical specifications for the Network Interface Controller.
MAC Address	Displays the technical specifications for the Network Interface Controller.
Virtual MAC Address	Displays the technical specifications for the Network Interface Controller.

## 5-2-15 MAC IPv4 Network Configuration

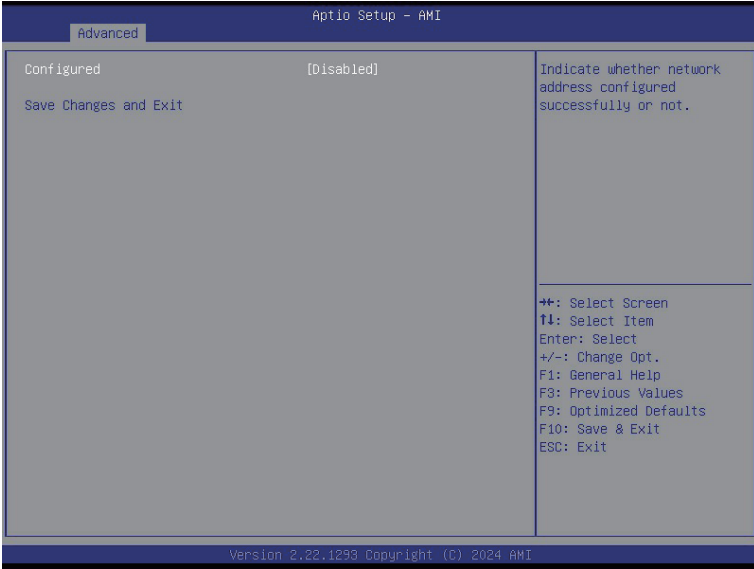

Parameter	Description
Configured	Indicates whether network address is configured successfully or not. Options available: Enabled, Disabled. Default setting is <b>Disabled</b> .
Enable DHCP	Options available: Enabled, Disabled. Default setting is <b>Disabled</b> .
Local IP Address	Press [Enter] to configure local IP address.
Local NetMask	Press [Enter] to configure local NetMask.
Local Gateway	Press [Enter] to configure local Gateway
Local DNS Servers	Press [Enter] to configure local DNS servers
Save Changes and Exit	Press [Enter] to save all configurations.

(Note) This item appears when **Configured** is set to **Enabled**.

## 5-2-16 MAC IPv6 Network Configuration

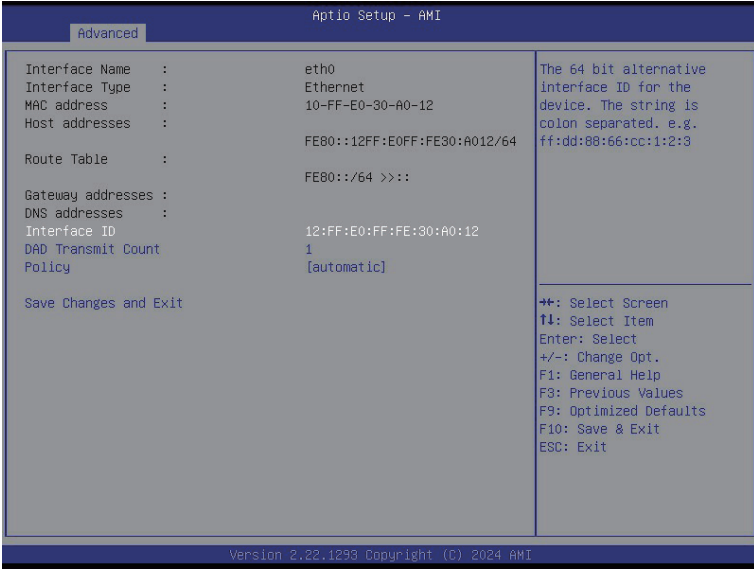

Parameter	Description
Enter Configuration Menu	<p>Press [Enter] to configure advanced items.</p> <ul style="list-style-type: none"> <li>◆ Displays the MAC Address information.</li> <li>◆ Interface ID                             <ul style="list-style-type: none"> <li>– The 64 bit alternative interface ID for the device. The string is colon separated. e.g. ff:dd:88:66:cc:1:2:3.</li> </ul> </li> <li>◆ DAD Transmit Count                             <ul style="list-style-type: none"> <li>– The number of consecutive Neighbor solicitation messages sent while performing Duplicate Address Detection on a tentative address. A value of zero indicates that Duplicate Address Detection is not performed.</li> </ul> </li> <li>◆ Policy                             <ul style="list-style-type: none"> <li>– Options available: automatic, manual. Default setting is <b>automatic</b>.</li> </ul> </li> <li>◆ Save Changes and Exit                             <ul style="list-style-type: none"> <li>– Press [Enter] to save all configurations.</li> </ul> </li> </ul>

(Note) This item appears when **Configured** is set to **Enabled**.

## 5-2-17 RAM Disk Configuration



Parameter	Description
Disk Memory Type	Specifies the type of memory to use from available memory pool in system to create a disk. Options available: Boot Service Data, Reserved. Default setting is <b>Boot Service Data</b> .
Create Raw	Creates a raw RAM disk. <ul style="list-style-type: none"> <li>◆ Size (Hex) <ul style="list-style-type: none"> <li>– Input a valid RAM disk size that should be multiple of the RAM disk block size.</li> </ul> </li> <li>◆ Create &amp; Exit</li> <li>◆ Discard &amp; Exit</li> </ul>
Create from file	Creates a RAM disk from a given file.
Created RAM disk list	
Remove selected RAM disk(s)	Selects the RAM disk(s) to remove.

## 5-2-18 Driver Health

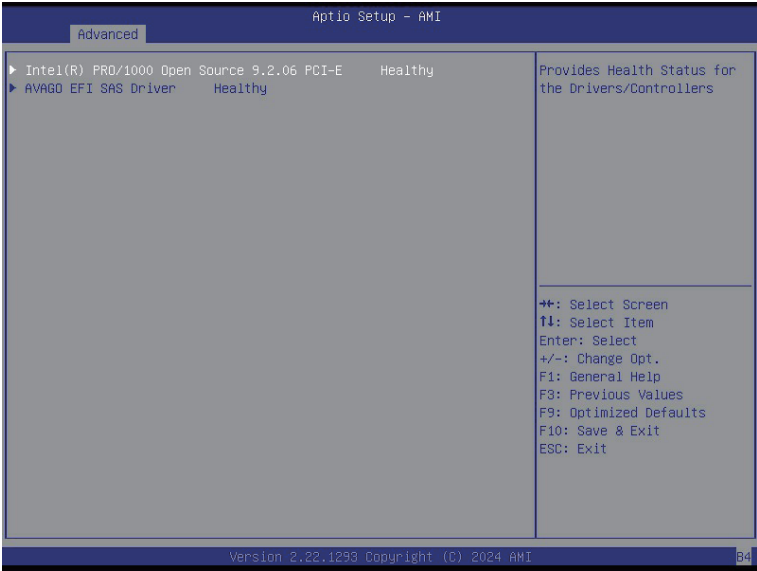

Parameter	Description
Driver Health	Displays driver health status of the devices/controllers if installed



## 5-3 Chipset Menu

The Chipset Setup menu displays submenu options for configuring the chipset functions. Select a submenu item, then press <Enter> to access the related submenu screen.



Parameter	Description
Memory Configuration	Press [Enter] to configure advanced items.
CPU Configuration	Press [Enter] to configure advanced items.
ACPI Configuration	Press [Enter] to configure advanced items.
PCIE Device Configuration	Press [Enter] to configure advanced items.
PCIE Root Complex Configuration	Press [Enter] to configure advanced items.
Power Policy	Press [Enter] to configure advanced items.
Power Button 1s shutdown	Option available: Enabled, Disabled. Default setting is <b>Enabled</b> .

### 5-3-1 Memory Configuration

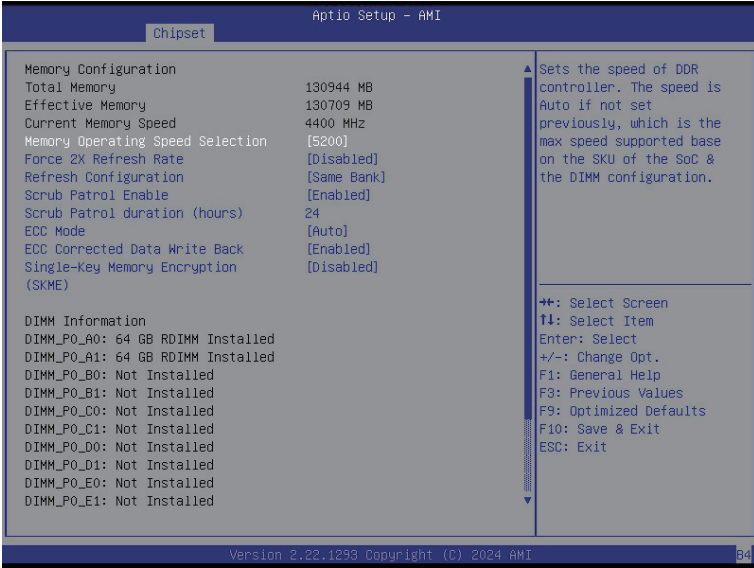

Parameter	Description
Memory Configuration	
Total Memory	
Effective Memory	
Current Memory Speed	
Memory Operating Speed Selection	Sets the speed of DDR controller . The speed is Auto if not set previously, which is the max speed supported base on the SKU of the SocC & the DIMM configuration. Option available: Auto/3200/3600/4000/4400/4800/ <b>5200</b> /5600/
Force 2X Refresh Rate	This option doubles DDR5 refresh rate as if always in high-temp condition. Option available: Enabled, Disabled. Default setting is <b>Disabled</b> .
Refresh Configuration	Select DDR Refresh mode: Normal, Fine Granularity or Same Bank. Option available: Normal, Fine Granularity, Same Back . Default setting is <b>Same Bank</b> .
Scrub Patrol Enable	Option available: Enabled, Disabled. Default setting is <b>Enabled</b> .

Parameter	Description
Scrub Patrol Duration (hours)	Select duration (hours) for scrub Patrol.
ECC Mode	Option available: Auto, Dsiabled, SECEDED 64+8, SECEDED 128+4+9, symbol 64+16, Symbol 64+14+2, Symbol 256+8+24. Default setting is <b>Auto</b> .
ECC Corrected Data Write Back	Option available: Enabled, Disabled. Default setting is <b>Enabled</b> .
Singlee-Key Memory Encryption (SKME)	Option available: Enabled, Disabled. Default setting is <b>Disabled</b> .
DIMM Information	Displays the installed memory technical information.

### 5-3-2 CPU Configuration

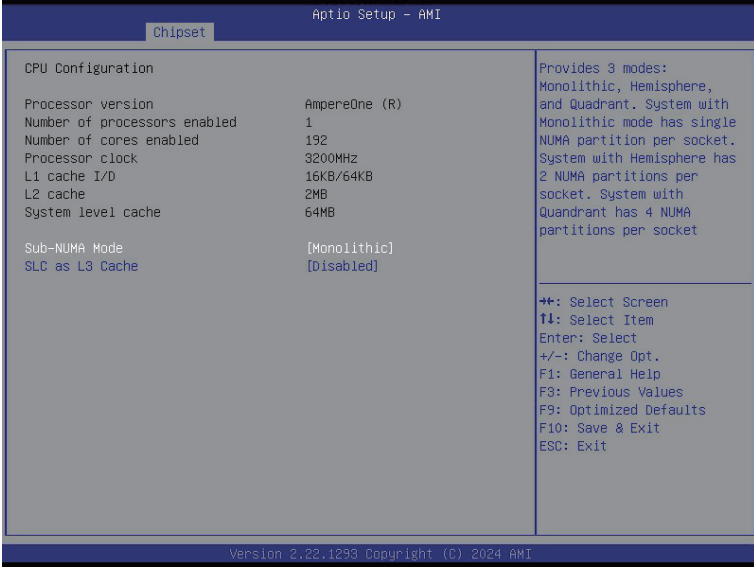

Parameter	Description
CPU Configuration	
Processor Version/Number of processor enabled/ number of cores enabled/ Processor clock/ L1 cache I/D/ L2 cache/ System level cache	Displays the technical specifications for the installed processor(s).
Sub-NUMA Mode	Option available: Monolithic, Hemisphere, Quadrant. Default setting is <b>Monolithic</b> .
SLC as L3 Cache	Option available: Enabled, Disabled. Default setting is <b>Disabled</b> .

### 5-3-3 ACPI Configuration

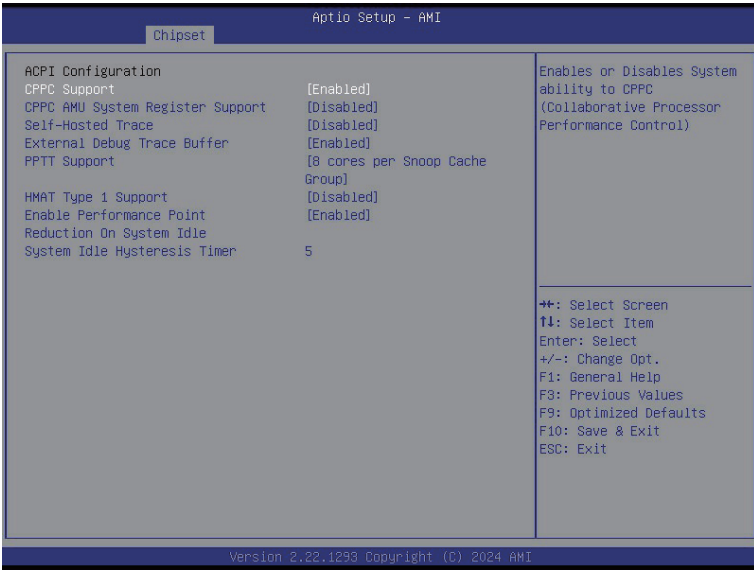

Parameter	Description
ACPI Configuration	
CPPC Support	Option available: Enabled, Disabled. Default setting is <b>Enabled</b> .
CPPC AMU System Register Support	Option available: Enabled, Disabled. Default setting is <b>Disabled</b> .
Self-Hosted Trace	Option available: Enabled, Disabled. Default setting is <b>Disabled</b> .
External Debug trace Buffer	Option available: Enabled, Disabled. Default setting is <b>Enabled</b> .
PPTT Support	Option available: Flat, CM-based, 8 coresper Snoop Cache Group, Anti Snoop Cache Group. Default setting is <b>8 coresper Snoop Cache Group</b> .
HMAT Type 1 Support	Option available: Enabled, Disabled. Default setting is <b>Disabled</b> .
Enable Performance PointReduction on System Table	Option available: Enabled, Disabled. Default setting is <b>Enabled</b> .
System Idle Hysteresis Timer	Values of system mldle Hysteresis Timer.

### 5-3-4 PCIe Device Configuration

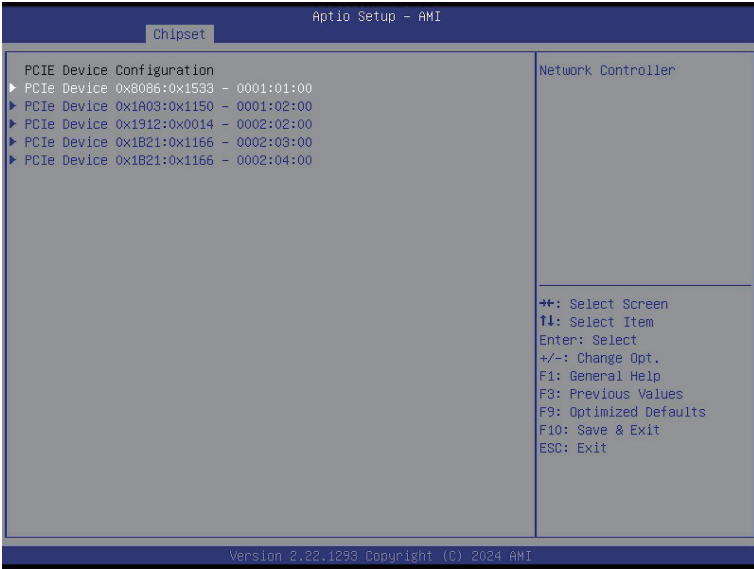

Parameter	Description
PCIe Device Configuration	Press [Enter] to configure advanced items.
PCIe Device Configuration	<ul style="list-style-type: none"> <li>◆ Max_Payload_Size/Max_Read_Request_Size_Mode               <ul style="list-style-type: none"> <li>– Options available: Auto, Manual. Default setting is <b>Auto</b>.</li> </ul> </li> <li>◆ Max Payload Size.               <ul style="list-style-type: none"> <li>– Options available: 512 bytes, 256 bytes, 128 bytes., Disabled. Default setting is <b>512 bytes</b>.</li> </ul> </li> <li>◆ Max Read Request Size               <ul style="list-style-type: none"> <li>– Options available: 4096 bytes, 2048 bytes, 1024 bytes, 512 bytes, 256 bytes, 128 bytes., Disabled. Default setting is <b>512 bytes</b>.</li> </ul> </li> <li>◆ Enabled SERR#               <ul style="list-style-type: none"> <li>– Option available: Enabled, Disabled. Default setting is <b>Enabled</b>.</li> </ul> </li> </ul>

### 5-3-5 PCIe Root Complex Configuration

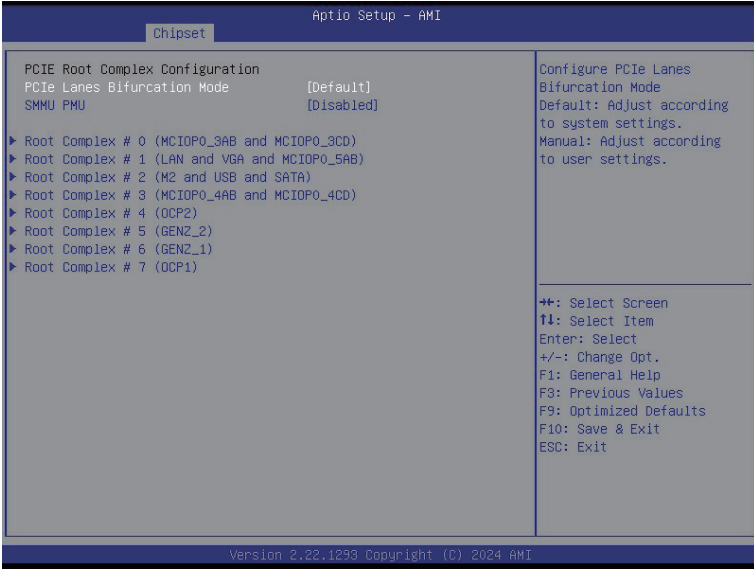

Parameter	Description
PCIe Root Complex Configuration	
PCIe Lanes Bifurcation	Option available: Manual/Default. Default setting: <b>Default</b> .
SMMU Pmu	Enable/Disable PMU feature for SMMU. Option available: Enabled/Disabled. Default setting: <b>Disabled</b> .
Root Complex_# <sup>(Note)</sup>	Press [Enter] to view advanced items.

(Note) Advance items can be configurable when PCIe Lanes Bifurcation is set to **Manual**.

### 5-3-6 Power Policy

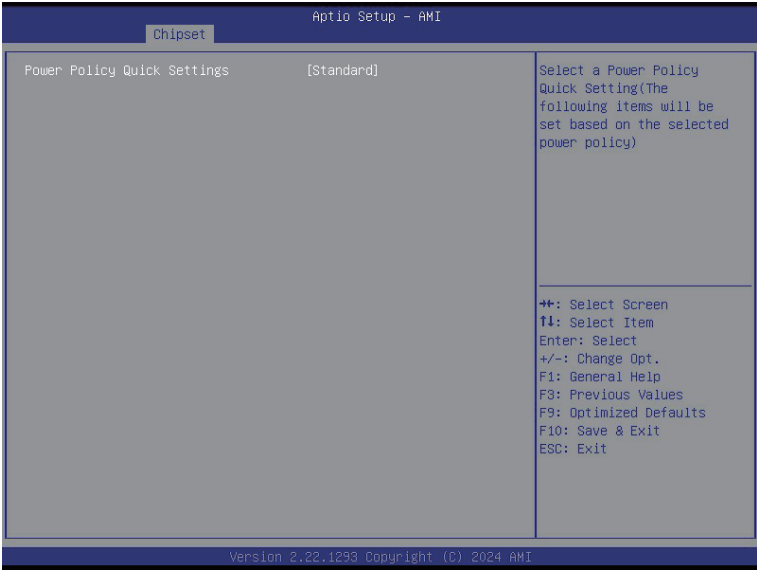

Parameter	Description
Power Policy	
Power Policy Quick Settings	Option available: Standard, Best Performance, Energy Efficient. Default setting: <b>Standard</b> .



## 5-4 Server Management Menu



Parameter	Description
BMC Self Test	
BMC Device ID	Displays BMC related information .
BMC Device revision	
IPMI Version	
IPMI BMC Interface	Displays IPMI related information .
BMC Support	Enable/Disable interfaces to communicate with BMC. Options available: Enabled/Disabled. Default setting is <b>Enabled</b> .

(Note1) This item is configurable when **FRB-2 Timer** is set to **Enabled**.

(Note2) This item is configurable when **OS Watchdog Timer** is set to **Enabled**.

Parameter	Description
FRB-2 Timer	Enable/Disable FRB-2 timer (POST timer). Options available: Enabled, Disabled. Default setting is <b>Enabled</b> .
FRB-2 Timer <sup>(Note1)</sup> timeout	Configures the FRB2 Timer timeout. The value is between 1 to 30 minutes. Default setting is <b>6 minutes</b> .
FRB-2 Timer Policy <sup>(Note1)</sup>	Configures the FRB2 Timer policy. Options available: Do Nothing, Reset, Power Down, Power Cycle. Default setting is <b>Do Nothing</b> .
OS Watchdog Timer	Enable/Disable OS Watchdog Timer function. Options available: Enabled, Disabled. Default setting is <b>Disabled</b> .
OS Wtd Timer Timeout <sup>(Note2)</sup>	Configures OS Watchdog Timer. The value is between 1 to 30 minutes. Default setting is <b>10 minutes</b> .
OS Wtd Timer Policy <sup>(Note2)</sup>	Configure OS Watchdog Timer Policy. Options available: Reset, Do Nothing, Power Down, Power Cycle. Default setting is <b>Reset</b> .
Wait BMC Ready	POST wait BMC ready and reboot system. Options available: Disabled, 2 minutes, 4 minutes, 6 minutes. Default setting is <b>2 minutes</b> .
System Event Log	Press [Enter] to configure advanced items.
View FRU Information	Press [Enter] to view the FRU information.
BMC self test log	Press [Enter] to configure advanced items.
BMC VLAN Configuration	Press [Enter] to configure advanced items.
BMC network Configuration	Press [Enter] to configure advanced items.
IPv6 BMC Network Configuration	Press [Enter] to configure advanced items.

## 5-4-1 System Event Log

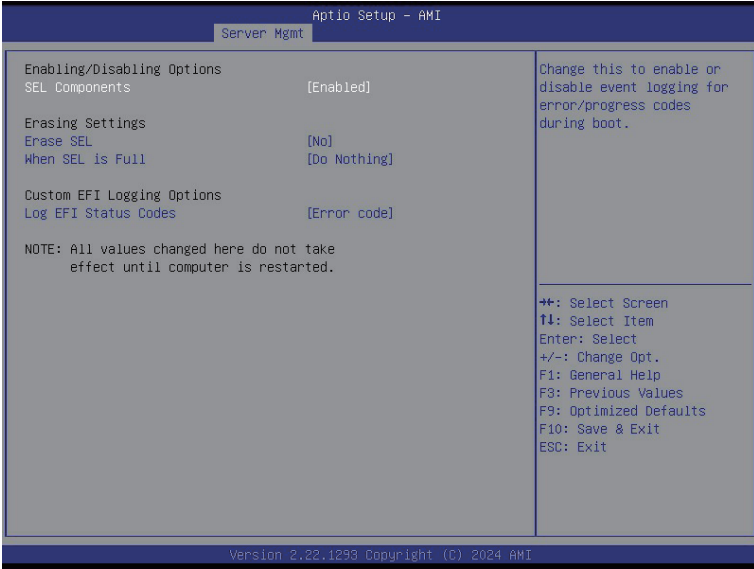

Parameter	Description
Enabling / Disabling Options	
SEL Components	Change this item to enable or disable all features of System Event Logging during boot. Options available: Enabled, Disabled. Default setting is <b>Enabled</b> .
Erasing Settings	
Erase SEL	Choose options for erasing SEL. Options available: No, Yes, On next reset, Yes, On every reset. Default setting is <b>No</b> .
When SEL is Full	Choose options for reactions to a full SEL. Options available: Do Nothing, Erase Immediately, Delete Oldest Record. Default setting is <b>Do Nothing</b> .
Custom EFI Logging Options	
Log EFI Status Codes	Enable/Disable the logging of EFI Status Codes (if not already converted to legacy). Options available: Disabled, Both, Error code, Progress code. Default setting is <b>Error code</b> .

## 5-4-2 View FRU Information

The FRU page is a simple display page for basic system ID information, as well as System product information. Items on this window are non-configurable.

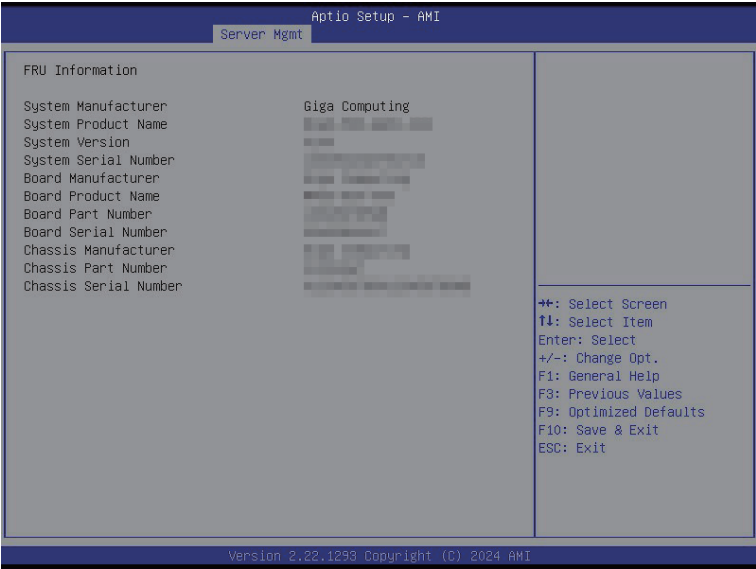

(Note) The model name will vary depends on the product you purchased

### 5-4-3 BMC self test log

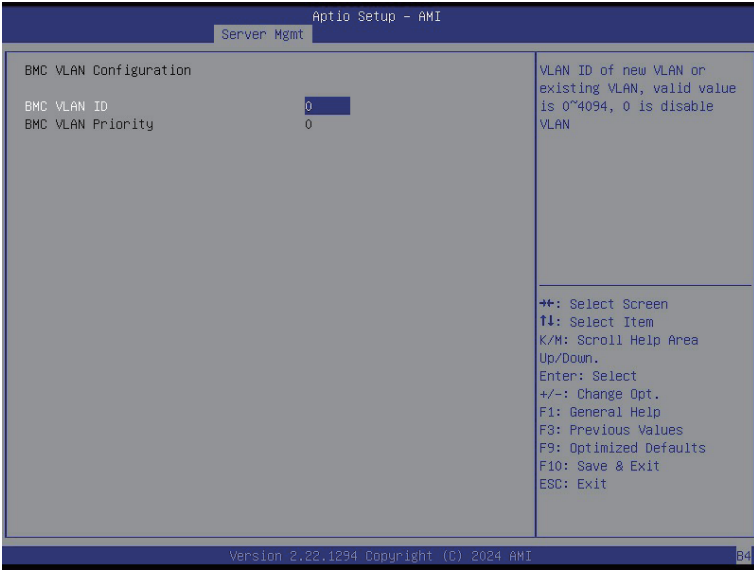

Parameter	Description
log area usage =00 out of 20 logs	
Erase Log	Options available: No/Yes, On next reset/Yes, On every reset. Default setting is <b>No</b> .
When Log is full	Configuration for reactions to a full log. Option available: Do not log any more/Clear Log. Default setting is <b>Do not log any more</b> .

### 5-4-4 BMC VLAN Configuration

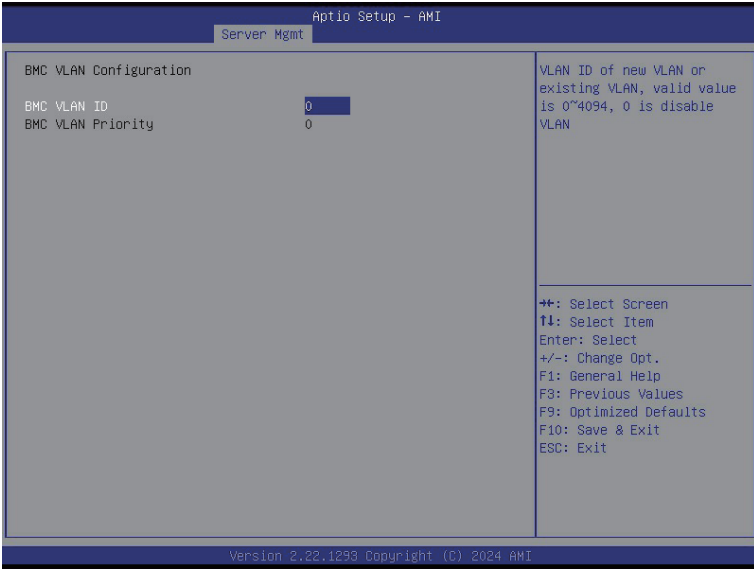

Parameter	Description
BMC VLAN Configuration	
BMC VLAN ID	Select to configure BMC VLAN ID. The valid range is from 0 to 4094. When set to 0, BMC VLAN ID will be disabled.
BMC VLAN Priority	Select to configure BMC VLAN Priority. The valid range is from 0 to 7. When BMC VLAN ID is set to 0, BMC VLAN Priority will not be selected.

## 5-4-5 BMC Network Configuration

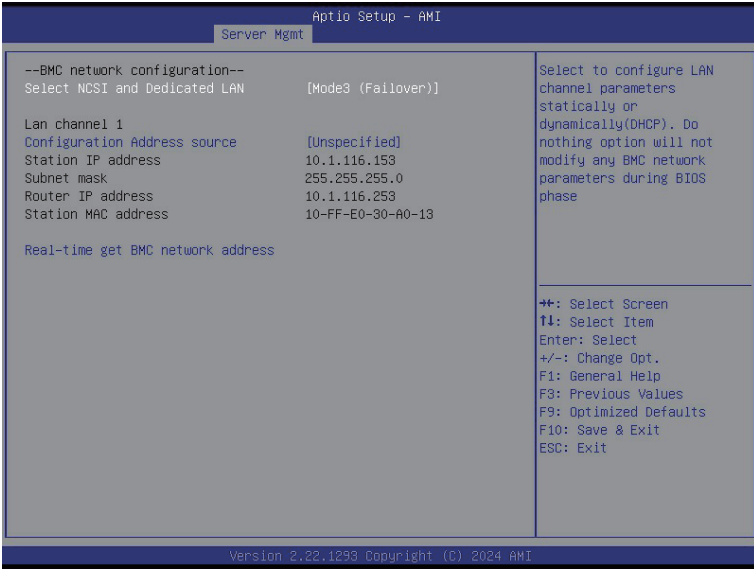

Parameter	Description
BMC network configuration	
Select NCSI and Dedicated LAN	Options available: Do Nothing, Model1(Dedicated), Model2(NCSI), Mode3(Failover). Default setting is <b>Do Nothing</b> .
Lan Channel 1	
Configuration Address source	Selects to configure LAN channel parameters statically or dynamically (DHCP). Options available: Unspecified, Static, DynamicBmcDhcp. Default setting is <b>DynamicBmcDhcp</b> .
Station IP address	Displays IP Address information.
Subnet mask	Displays Subnet Mask information. Please note that the IP address must be in three digitals, for example, 192.168.000.001.
Router IP address	Displays the Router IP Address information.
Station MAC address	Displays the MAC Address information.
Real-time get BMC network address	Press [Enter] will set LAN mode and Address source and then get IP, Subnet, Gateway and MAC address.

## 5-4-6 IPv6 BMC Network Configuration

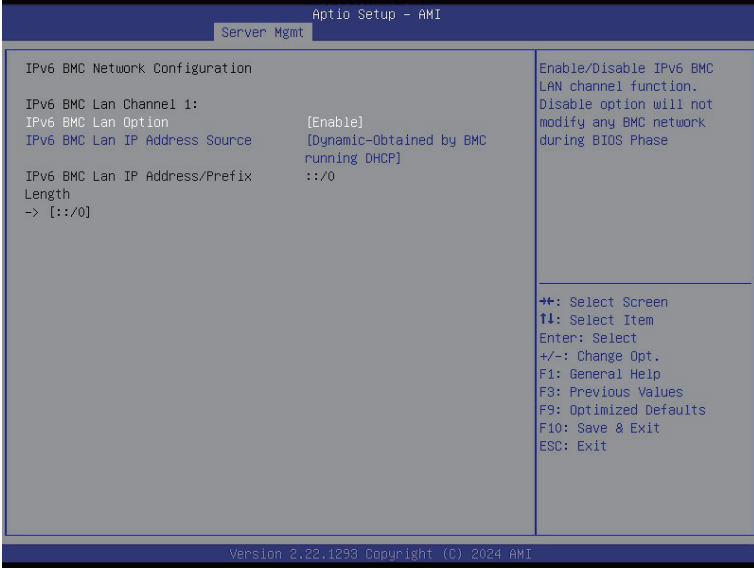

Parameter	Description
IPv6 BMC network configuration	
IPv6 BMC Lan Channel 1	
IPv6 BMC Lan Option	Enable/Disable IPv6 BMC LAN channel function. When this item is disabled, the system will not modify any BMC network during BIOS phase. Options available: Unspecified, Disable, Enable. Default setting is <b>Enable</b> .
IPv6 BMC Lan IP Address Source	Selects to configure LAN channel parameters statically or dynamically (by BIOS or BMC). Options available: Unspecified, Static, Dynamic-Obtained by BMC running DHCP. Default setting is <b>Dynamic-Obtained by BMC running DHCP</b> .
IPv6 BMC Lan IP Address/Prefix Length	Check if the IPv6 BMC LAN IP address matches those displayed on the screen.



## 5-5 Security Menu

The Security menu allows you to safeguard and protect the system from unauthorized use by setting up access passwords.

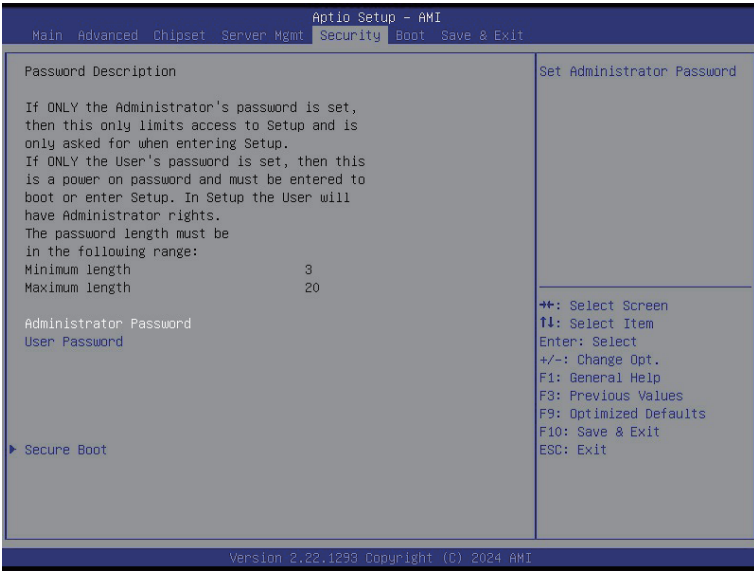

There are two types of passwords that you can set:

- **Administrator Password**  
Entering this password will allow the user to access and change all settings in the Setup Utility.
- **User Password**  
Entering this password will restrict a user's access to the Setup menus. To enable or disable this field, a Administrator Password must first be set. A user can only access and modify the System Time, System Date, and Set User Password fields.

Parameter	Description
Administrator Password	Press [Enter] to configure the administrator password.
User Password	Press [Enter] to configure the user password.
Secure Boot	Press [Enter] to configure advanced items.

## 5-5-1 Secure Boot

The Secure Boot feature is applicable if supported by your Operating System.

If your Operating System is not supporting Secure Boot, the system will hang when starting the Operating System.



Parameter	Description
System Mode	Displays if the system is in User mode or Setup mode.
Secure Boot	Enable/ Disable the Secure Boot function. Options available: Enabled, Disabled. Default setting is <b>Disabled</b> .
Secure Boot Mode <sup>(Note)</sup>	Secure Boot requires all the applications that are running during the booting process to be pre-signed with valid digital certificates. This way, the system knows all files being loaded before the Operating System loads to the login screen have not been tampered with. When set to Standard, it will automatically load the Secure Boot keys form the BIOS databases. When set to Custom, you can customize the Secure Boot settings and manually load its keys from the BIOS database. Options available: Standard, Custom. Default setting is <b>Standard</b> .
Restore Factory Keys	Forces the system to user mode and installs factory default Secure Boot key database.
Reset To Setup Mode	Reset the system to Setup Mode.

(Note) Advanced items prompt when this item is set to **Custom**.

Parameter	Description
Key Management	<p data-bbox="335 156 665 180">Press [Enter] to configure advanced items.</p> <p data-bbox="335 185 941 235"><b>Please note that this item is configurable when Secure Boot Mode is set to Custom.</b></p> <ul style="list-style-type: none"> <li data-bbox="335 243 946 352">◆ Factory Key Provision <ul style="list-style-type: none"> <li data-bbox="367 266 946 321">– Allows to provision factory default Secure Boot keys when system is in Setup Mode.</li> <li data-bbox="367 326 909 352">– Options available: Enabled, Disabled. Default setting is <b>Disabled</b>.</li> </ul> </li> <li data-bbox="335 357 931 431">◆ Restore Factory Keys <ul style="list-style-type: none"> <li data-bbox="367 381 931 404">– Installs all factory default keys. It will force the system in User Mode.</li> <li data-bbox="367 409 606 431">– Options available: Yes, No.</li> </ul> </li> <li data-bbox="335 435 654 517">◆ Reset To Setup Mode <ul style="list-style-type: none"> <li data-bbox="367 459 654 482">– Reset the system to Setup Mode.</li> <li data-bbox="367 487 606 517">– Options available: Yes, No.</li> </ul> </li> <li data-bbox="335 522 904 603">◆ Enroll Efi Image <ul style="list-style-type: none"> <li data-bbox="367 545 904 603">– Press [Enter] to enroll SHA256 hash of the binary into Authorized Signature Database (db).</li> </ul> </li> <li data-bbox="335 608 941 682">◆ Export Secure Boot variables <ul style="list-style-type: none"> <li data-bbox="367 631 941 682">– Copy NVRAM content of Secure Boot variables to files in a root folder on a file system device.</li> </ul> </li> <li data-bbox="335 686 899 744">◆ Secure Boot variable <ul style="list-style-type: none"> <li data-bbox="367 710 899 744">– Displays the current status of the variables used for secure boot.</li> </ul> </li> <li data-bbox="335 749 803 854">◆ Platform Key (PK) <ul style="list-style-type: none"> <li data-bbox="367 773 803 796">– Displays the current status of the Platform Key (PK).</li> <li data-bbox="367 801 680 824">– Press [Enter] to configure a new PK.</li> <li data-bbox="367 829 601 854">– Options available: Update.</li> </ul> </li> <li data-bbox="335 859 941 995">◆ Key Exchange Keys (KEK) <ul style="list-style-type: none"> <li data-bbox="367 882 941 906">– Displays the current status of the Key Exchange Key Database (KEK).</li> <li data-bbox="367 911 909 964">– Press [Enter] to configure a new KEK or load additional KEK from storage devices.</li> <li data-bbox="367 969 670 995">– Options available: Update, Append.</li> </ul> </li> <li data-bbox="335 1000 941 1136">◆ Authorized Signatures (DB) <ul style="list-style-type: none"> <li data-bbox="367 1023 909 1047">– Displays the current status of the Authorized Signature Database.</li> <li data-bbox="367 1052 941 1105">– Press [Enter] to configure a new DB or load additional DB from storage devices.</li> <li data-bbox="367 1110 670 1136">– Options available: Update, Append.</li> </ul> </li> <li data-bbox="335 1141 904 1277">◆ Forbidden Signatures (DBX) <ul style="list-style-type: none"> <li data-bbox="367 1165 904 1188">– Displays the current status of the Forbidden Signature Database.</li> <li data-bbox="367 1193 893 1246">– Press [Enter] to configure a new dbx or load additional dbx from storage devices.</li> <li data-bbox="367 1251 670 1277">– Options available: Update, Append.</li> </ul> </li> </ul>

Parameter	Description
Key Management (continued)	<ul style="list-style-type: none"> <li>◆ Authorized TimeStamps (DBT) <ul style="list-style-type: none"> <li>– Displays the current status of the Authorized TimeStamps Database.</li> <li>– Press [Enter] to configure a new DBT or load additional DBT from storage devices.</li> <li>– Options available: Update, Append.</li> </ul> </li> <li>◆ OsRecovery Signatures <ul style="list-style-type: none"> <li>– Displays the current status of the OsRecovery Signature Database.</li> <li>– Press [Enter] to configure a new OsRecovery Signature or load additional OsRecovery Signature from storage devices.</li> <li>– Options available: Update, Append.</li> </ul> </li> </ul>

## 5-6 Boot Menu

The Boot menu allows you to set the drive priority during system boot-up. BIOS setup will display an error message if the legacy drive(s) specified is not bootable.

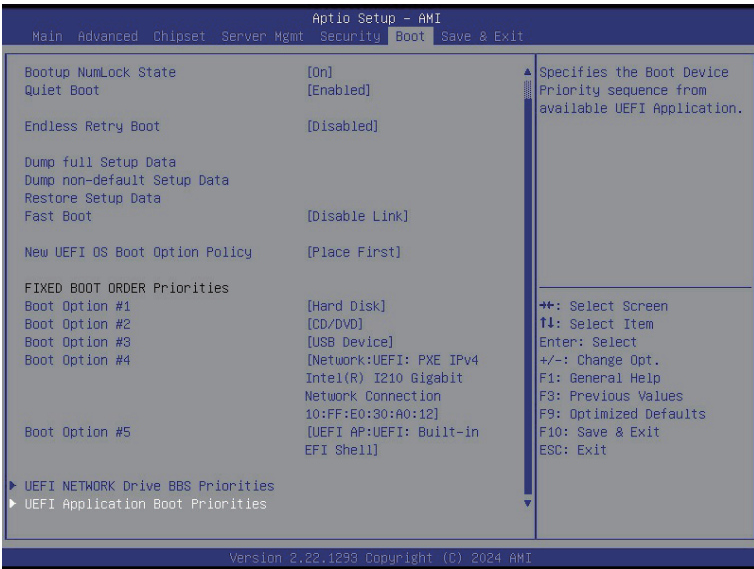
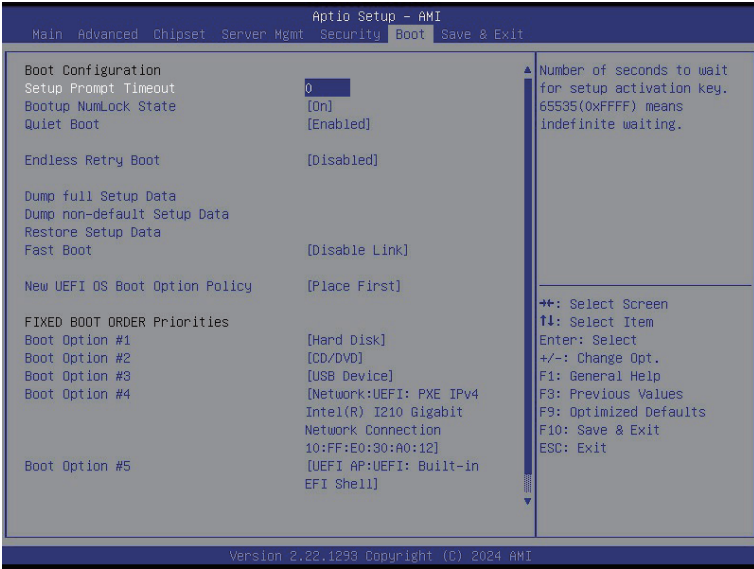

Parameter	Description
Boot Configuration	
Setup Prompt Timeout	Number of seconds to wait for setup activation key. 65535 (0xFFFF) means indefinite waiting. Press the numeric keys to input the desired values.
Bootup NumLock State	Enable/Disable the Bootup NumLock function. Options available: On, Off. Default setting is <b>On</b> .
Quiet Boot	Enable/Disable showing the logo during POST. Options available: Enabled, Disabled. Default setting is <b>Enabled</b> .
Endless Retry Boot	Options available: Disable, Enable. Default setting is <b>Disable</b> .
Setup Flash	Press [Enter] to run setup flash.
Dump full Setup Data	Press [Enter] to dump full setup data to file.
Dump non-default Setup Data	Press [Enter] to dump non-default setup data to file.
Restore Setup Data	Press [Enter] to restore setup data from file.
FIXED BOOT ORDER	
Priorities	
Boot Option #1 / #2 / #3 / #4 / #5	Press [Enter] to configure the boot order priority. By default, the server searches for boot devices in the following sequence: <ol style="list-style-type: none"> <li>1. Hard drive.</li> <li>2. CD-COM/DVD drive.</li> <li>3. USB device.</li> <li>4. Network.</li> <li>5. UEFI.</li> </ol>
UEFI Network Drive BBS Priorities	Press [Enter] to configure the boot priority.
UEFI Application Boot Priorities	Press [Enter] to configure the boot priority.

## 5-7 Save & Exit Menu

The Save & Exit menu displays the various options to quit from the BIOS setup. Highlight any of the exit options then press <Enter>.

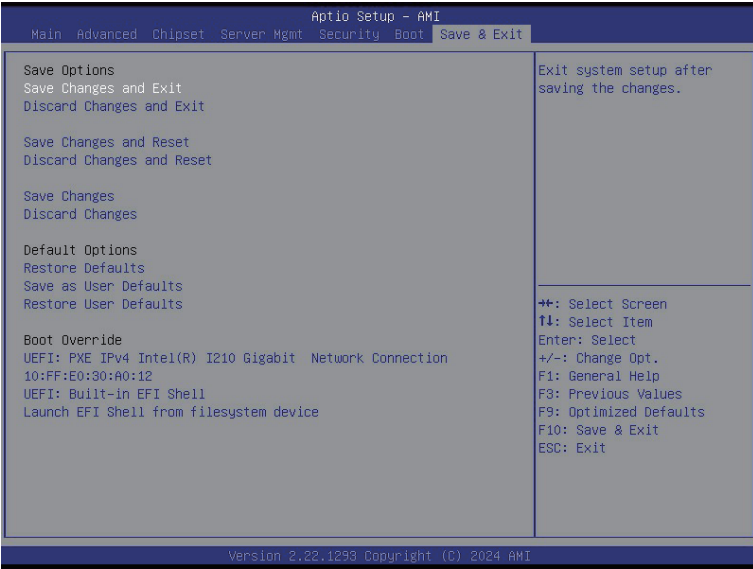

Parameter	Description
Save Options	
Save and Exit	Saves changes made and closes the BIOS setup. Options available: Yes, No.
Discard changes and exit	Discards changes made and exits the BIOS setup. Options available: Yes, No.
Save Changes and Reset	Restarts the system after saving the changes made. Options available: Yes, No.
Discard Changes and Reset	Restarts the system without saving any changes. Options available: Yes, No.
Save Changes	Saves changes done so far to any of the setup options. Options available: Yes, No.
Discard Changes	Discards changes made and closes the BIOS setup. Options available: Yes, No.
Default Options	

<b>Parameter</b>	<b>Description</b>
Restore Defaults	Loads the default settings for all BIOS setup parameters. Setup Defaults are quite demanding in terms of resources consumption. If you are using low-speed memory chips or other kinds of low-performance components and you choose to load these settings, the system might not function properly. Options available: Yes, No.
Save the User Default Values	Saves the changes made as the user default settings. Options available: Yes, No.
Restore the User Default Values	Loads the user default settings for all BIOS setup parameters. Options available: Yes, No.
Boot Device Priority	Press [Enter] to configure the device as the boot-up drive.
Launch EFI Shell	Attempts to Launch EFI Shell application (Shell.efi) from one of the available file system devices.



# 5-8 BIOS Recovery

The system has an embedded recovery technique. In the event that the BIOS becomes corrupt the boot block can be used to restore the BIOS to a working state. To restore your BIOS, please follow the instructions listed below:

Recovery Instruction:

1. Copy the XXX.rom to USB diskette.
2. Setting BIOS Recovery jump to enabled status.
3. Boot into BIOS recovery.
4. Run Proceed with flash update.
5. BIOS updated.

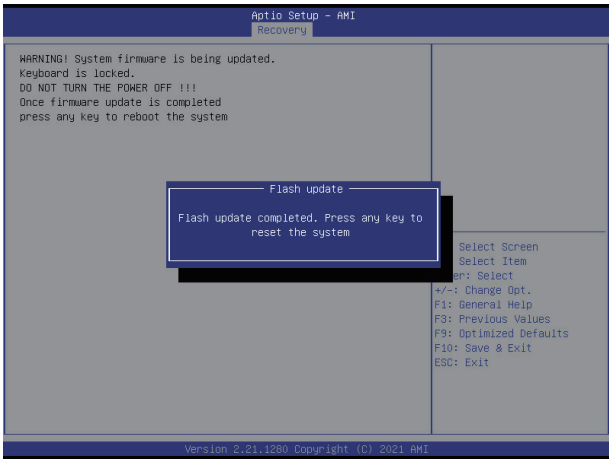

## 5-9 BIOS POST Beep code (AMI standard)

### 5-9-1 PEI Beep Codes

# of Beeps	Description
1	Memory not Installed.
1	Memory was installed twice (InstallPeiMemory routine in PEI Core called twice)
2	Recovery started
3	DXE IPL was not found
3	DXE Core Firmware Volume was not found
4	Recovery failed
4	S3 Resume failed
7	Reset PPI is not available

### 5-9-2 DXE Beep Codes

# of Beeps	Description
1	Invalid password
4	Some of the Architectural Protocols are not available
5	No Console Output Devices are found
5	No Console Input Devices are found
6	Flash update is failed
7	Reset protocol is not available
8	Platform PCI resource requirements cannot be met