

GIGABYTE™

R133-C11-AAB1

R133-C11-AAG1

AMD Ryzen™ 7000 Server System - 1U UP 8-Bay SATA

Dual 550W (240V) 80 PLUS Platinum redundant power supply (AAB1)

Dual 800W (240V) 80 PLUS Titanium redundant power supply (AAG1)

User Manual

Rev. 1.0

Copyright

© 2023 Giga Computing Technology CO., LTD. All rights reserved.

The trademarks mentioned in this manual are legally registered to their respective owners.

Disclaimer

Information in this manual is protected by copyright laws and is the property of Giga Computing. Changes to the specifications and features in this manual may be made by Giga Computing without prior notice. No part of this manual may be reproduced, copied, translated, transmitted, or published in any form or by any means without Giga Computing's prior written permission.

Documentation Classifications

In order to assist in the use of this product, Giga Computing provides the following types of documentation:

- User Manual: detailed information & steps about the installation, configuration and use of this product (e.g. motherboard, server barebones), covering hardware and BIOS.
- User Guide: detailed information about the installation & use of an add-on hardware or software component (e.g. BMC firmware, rail-kit) compatible with this product.
- Quick Installation Guide: a short guide with visual diagrams that you can reference easily for installation purposes of this product (e.g. motherboard, server barebones).

Please see the support section of the online product page to check the current availability of these documents.

For More Information

For related product specifications, the latest firmware and software, and other information please visit our website at <http://www.gigabyte.com/Enterprise>

For GIGABYTE distributors and resellers, additional sales & marketing materials are available from our reseller portal: <http://reseller.b2b.gigabyte.com>

For further technical assistance, please contact your GIGABYTE representative or visit <https://support.gigabyte.com/> to create a new support ticket

For any general sales or marketing enquiries, you may also message GIGABYTE server directly by email: server.grp@gigabyte.com

Conventions

The following conventions are used in this user's guide:

	NOTE! Pieces of additional information related to the current topic.
	CAUTION! Precautionary measures to avoid possible hardware or software problems.
	WARNING! Alerts to any damage that might result from doing or not doing specific actions.

Server Warnings and Cautions

Before installing a server, be sure that you understand the following warnings and cautions.



WARNING!

To reduce the risk of electric shock or damage to the equipment:

- Do not disable the power cord grounding plug. The grounding plug is an important safety feature.
- Plug the power cord into a grounded (earthed) electrical outlet that is easily accessible at all times.
- Unplug the power cord from the power supply to disconnect power to the equipment.
- Do not route the power cord where it can be walked on or pinched by items placed against it. Pay particular attention to the plug, electrical outlet, and the point where the cord extends from the server.



WARNING!

To reduce the risk of personal injury from hot surfaces, allow the drives and the internal system components to cool before touching them.



WARNING!

This server is equipped with high speed fans. Keep away from hazardous moving fan blades during servicing.



CAUTION!

- Do not operate the server for long periods with the access panel open or removed. Operating the server in this manner results in improper airflow and improper cooling that can lead to thermal damage.
- Danger of explosion if battery is incorrectly replaced.
- Replace battery with the same or equivalent type recommended by the manufacturer.
- Dispose of used batteries according to the manufacturer's instructions.



CAUTION!

Risk of explosion if battery is replaced incorrectly or with an incorrect type. Replace the battery only with the same or equivalent type recommended by the manufacturer. Dispose of used batteries according to the manufacturer's instructions.



Electrostatic Discharge (ESD)

CAUTION!

ESD CAN DAMAGE DRIVES, BOARDS, AND OTHER PARTS. WE RECOMMEND THAT YOU PERFORM ALL PROCEDURES AT AN ESD WORKSTATION. IF ONE IS NOT AVAILABLE, PROVIDE SOME ESD PROTECTION BY WEARING AN ANTI-STATIC WRIST STRAP ATTACHED TO CHASSIS GROUND -- ANY UNPAINTED METAL SURFACE -- ON YOUR SERVER WHEN HANDLING PARTS.

Always handle boards carefully, they can be extremely sensitive to ESD. Hold boards only by their edges without touching any components or connectors. After removing a board from its protective ESD bag or from the system, place the board component side up on a grounded, static free surface. Use a conductive foam pad if available but not the ESD bag. Do not slide the board over any surface.

System power on/off: To service components within the server, please ensure the power has been disconnected.

e.g. Remove the node from the server chassis (to disconnect power) or disconnect the power from the server chassis.

Make sure the system is removed from the rack before opening the chassis, adding, or removing any non hot-plug components.

Hazardous conditions, devices and cables: Hazardous electrical conditions may be present on power, telephone, and communication cables. Turn off the system chassis and disconnect the cables attached to the system before servicing the chassis. Otherwise, personal injury or equipment damage can result.

Electrostatic discharge (ESD) and ESD protection: ESD can damage drives, boards, and other parts. We recommend that you perform all procedures in this chapter only at an ESD workstation. If one is not available, provide some ESD protection by wearing an antistatic wrist strap attached to chassis ground (any unpainted metal surface on the server) when handling parts.

ESD and handling boards: Always handle boards carefully. They can be extremely sensitive to electrostatic discharge (ESD). Hold boards only by their edges. After removing a board from its protective wrapper or from the system, place the board component side up on a grounded, static free surface. Use a conductive foam pad if available but not the board wrapper. Do not slide board over any surface.

Installing or removing jumpers: A jumper is a small plastic encased conductor that slips over two jumper pins. Some jumpers have a small tab on top that can be gripped with fingertips or with a pair of fine needle nosed pliers. If the jumpers do not have such a tab, take care when using needle nosed pliers to remove or install a jumper; grip the narrow sides of the jumper with the pliers, never the wide sides. Gripping the wide sides can damage the contacts inside the jumper, causing intermittent problems with the function controlled by that jumper. Take care to grip with, but not squeeze, the pliers or other tool used to remove a jumper, or the pins on the board may bend or break.

Table of Contents

Chapter 1	Hardware Installation	11
1-1	Installation Precautions	11
1-2	Product Specifications	12
1-3	System Block Diagram	16
Chapter 2	System Appearance	17
2-1	Front View	17
2-2	Rear View	18
2-3	Front Panel LED and Buttons	19
2-4	Rear System LAN LEDs	20
2-5	Power Supply Unit LED	21
2-6	Hard Disk Drive LEDs	22
Chapter 3	System Hardware Installation	23
3-1	Removing and Installing the Chassis Cover	24
3-2	Removing and Installing the Hard Disk Drive	25
3-3	Removing and Installing the Fan Duct	28
3-4	Removing and Installing the Heat Sink	29
3-5	Removing and Installing the CPU and Heat sink	30
3-6	Removing and Installing Memory	32
3-6-1	Dual Channel Memory Configuration	32
3-6-2	Removing and Installing a Memory Module	33
3-6-3	Memory Module Population Table	33
3-7	Removing and Installing the PCIe Card	34
3-8	Installing the GPU Card (Optional)	35
3-9	Installing the M.2 Device and Heat Sink	36
3-10	Removing and Installing the Power Supply	37
3-11	Cable Routing	38
Chapter 4	Motherboard Components	44
4-1	Motherboard Components	44
4-2	Jumper Settings	46
4-3	Backplane Board Storage Connector	47
4-3-1	CBP1047	47
4-3-2	CBP1045	47

Chapter 5 BIOS Setup	48
5-1 The Main Menu	50
5-2 Advanced Menu	52
5-2-1 Trusted Computing	53
5-2-2 AMD fTPM Configuration.....	55
5-2-3 AST2600 Super IO Configuration	56
5-2-4 S5 RTC Wake Settings.....	58
5-2-5 Serial Port Console Redirection	59
5-2-6 CPU Configuration.....	63
5-2-7 PCI Subsystem Settings.....	64
5-2-8 USB Configuration.....	66
5-2-9 Network Stack Configuration	68
5-2-10 CSM Configuration	69
5-2-11 Post Report Configuration	70
5-2-12 NVMe Configuration	71
5-2-13 SATA Configuration.....	72
5-2-14 Chipset Configuration.....	73
5-2-15 RAM Disk Configuration	74
5-2-16 Tls Auth Configuration	75
5-2-17 iSCSI Configuration	76
5-2-18 Broadcom BCM7416 NetXtreme-E 10GBASE-T Network Connection	77
5-2-19 VLAN Configuration.....	80
5-2-20 MAC IPv4 Network Configuration.....	81
5-2-21 MAC IPv6 Network Configuration.....	82
5-2-22 Broadcom NetXtreme Gigabit Ethernet Network Connection	83
5-2-23 VLAN Configuration.....	85
5-2-24 MAC IPv4 Network Configuration.....	86
5-2-25 MAC IPv6 Network Configuration.....	87
5-2-26 Driver Health.....	88
5-3 Chipset Setup Menu.....	89
5-3-1 North Bridge	90
5-4 Server Management Menu.....	91
5-4-1 System Event Log	93
5-4-2 View FRU Information	94
5-4-3 BMC VLAN Configuration.....	95
5-4-4 BMC Network Configuration.....	96
5-4-5 IPv6 BMC Network Configuration.....	97
5-5 Security Menu	98
5-5-1 Secure Boot	99
5-6 Boot Menu.....	101
5-7 Save & Exit Menu.....	102

5-8 BIOS Recovery 104

5-9 BIOS POST Beep code (AMI standard)..... 105

5-9-1 PEI Beep Codes105

5-9-2 DXE Beep Codes105

This page intentionally left blank

Chapter 1 Hardware Installation

1-1 Installation Precautions

The motherboard/system contain numerous delicate electronic circuits and components which can become damaged as a result of electrostatic discharge (ESD). Prior to installation, carefully read the service guide and follow these procedures:









- Prior to installation, do not remove or break motherboard S/N (Serial Number) sticker or warranty sticker provided by your dealer. These stickers are required for warranty validation.
- Always remove the AC power by unplugging the power cord from the power outlet before installing or removing the motherboard or other hardware components.
- When connecting hardware components to the internal connectors on the motherboard, make sure they are connected tightly and securely.
- When handling the motherboard, avoid touching any metal leads or connectors.
- It is best to wear an electrostatic discharge (ESD) wrist strap when handling electronic components such as a motherboard, CPU or memory. If you do not have an ESD wrist strap, keep your hands dry and first touch a metal object to eliminate static electricity.
- Prior to installing the motherboard, please have it on top of an antistatic pad or within an electrostatic shielding container.
- Before unplugging the power supply cable from the motherboard, make sure the power supply has been turned off.
- Before turning on the power, make sure the power supply voltage has been set according to the local voltage standard.
- Before using the product, please verify that all cables and power connectors of your hardware components are connected.
- To prevent damage to the motherboard, do not allow screws to come in contact with the motherboard circuit or its components.
- Make sure there are no leftover screws or metal components placed on the motherboard or within the computer casing.
- Do not place the computer system on an uneven surface.
- Do not place the computer system in a high-temperature environment.
- Turning on the computer power during the installation process can lead to damage to system components as well as physical harm to the user.
- If you are uncertain about any installation steps or have a problem related to the use of the product, please consult a certified computer technician.

1-2 Product Specifications



NOTE:

We reserve the right to make any changes to the product specifications and product-related information without prior notice.

 System Dimension	<ul style="list-style-type: none">◆ 1U◆ 438 (W) x 43.5 (H) x 710 (D) mm
 CPU	<ul style="list-style-type: none">◆ AMD® Ryzen™ 7000 Series Processors◆ Single processor, 5nm technology◆ TDP up to 170W
 Socket	<ul style="list-style-type: none">◆ AM5
 Chipset	<ul style="list-style-type: none">◆ AMD® B650E
 Memory	<ul style="list-style-type: none">◆ 4 x DIMM slots◆ DDR5 memory supported only◆ Dual Channel memory architecture◆ DIMM modules up to 32GB supported◆ ECC Unbuffered DIMM 1Rx8/2Rx8 modules supported◆ Non-ECC Unbuffered DIMM 1Rx8/2Rx8/1Rx16 modules supported◆ Memory speed: up to 5200 MHz
 LAN	<ul style="list-style-type: none">◆ 2 x 10Gb/s LAN ports (1 x Broadcom® BCM57416)◆ 2 x 1Gb/s LAN ports (1 x Broadcom® BCM5720)◆ NCSI function supported on Broadcom® BCM5720 and BCM57416 (by switch)◆ 1 x 10/100/1000 management LAN
 Video	<ul style="list-style-type: none">◆ Integrated in Aspeed® AST2600◆ 2D Video Graphic Adapter with PCIe bus interface◆ 1920x1200@60Hz 32bpp, DDR4 SDRAM
 Storage	<p>Front side:</p> <ul style="list-style-type: none">◆ 4 x 3.5"/2.5" SATA hot-swappable bays◆ 4 x 2.5" 7mm SATA hot-swappable bays <p>SATA supported only</p>

**Expansion Slot****PCIe Cable:**

- ◆ 1 x PCIe x16 (Gen5 x16) FHFL slot, from CPU, for GPUs*
- ◆ *Max 300W for GPUs

Riser Card CRSE016:

- ◆ 1 x PCIe x4 (Gen4 x4) FHHL slot, from CPU

1 x M.2 slot:

- ◆ M-key
- ◆ PCIe Gen4 x4, from FCH
- ◆ Supports 2280/22110 cards

**Internal I/O**

- ◆ 2 x USB 3.2 Gen1
- ◆ 2 x USB 2.0
- ◆ 1 x Front panel header
- ◆ 1 x Back panel header
- ◆ 2 x Fan headers (4 pin)
- ◆ 1 x M.2 slot
- ◆ 1 x TPM header
- ◆ 1 x PMBus header

**Front I/O**

- ◆ 1 x USB 3.2 Gen1
- ◆ 1 x Power button with LED
- ◆ 1 x ID button with LED
- ◆ 1 x NMI button
- ◆ 1 x Reset button
- ◆ 2 x LAN activity LEDs
- ◆ 1 x HDD activity LED
- ◆ 1 x System status LED

**Rear Panel I/O**

- ◆ 2 x USB 3.2 Gen1
- ◆ 1 x Mini-DP
- ◆ 4 x RJ45
- ◆ 1 x MLAN
- ◆ 1 x ID button with LED

**Backplane I/O**

- ◆ Speed and bandwidth:
- ◆ SATA 6Gb/s

**TPM**

- ◆ 1 x TPM header with SPI interface
- ◆ Optional TPM2.0 kit: CTM010



Power Supply
(AAB1)

- ◆ Dual 800W (240V) 80 PLUS Platinum redundant PSU

AC Input:

- ◆ 100-240V~/ 10-5A, 50-60Hz

DC Input:

- ◆ 240Vdc/ 4A

DC Output:

- ◆ Max 800W/ 100-240V~ or 240Vdc Input
- ◆ + 12V/ 65A
- ◆ + 12Vsb/ 2.1A



Power Supply
(AAG1)

- ◆ Dual 800W (240V) 80 PLUS Titanium redundant PSU

AC Input:

- ◆ 100-127V~/ 10A, 50-60Hz
- ◆ 200-240V~/ 5A, 50-60Hz

DC Input:

- ◆ 240Vdc/ 5A

DC Output:

- ◆ Max 800W
- ◆ + 12.2V/ 65A
- ◆ + 12Vsb/ 3A



System Management

- ◆ Aspeed® AST2600 management controller
- ◆ GIGABYTE Management Console (AMI MegaRAC SP-X) web interface

- ◆ Dashboard
- ◆ HTML5 KVM
- ◆ Sensor Monitor (Voltage, RPM, Temperature, CPU Status ...etc.)
- ◆ Sensor Reading History Data
- ◆ FRU Information
- ◆ SEL Log in Linear Storage / Circular Storage Policy
- ◆ Hardware Inventory
- ◆ Fan Profile
- ◆ System Firewall
- ◆ Power Consumption
- ◆ Power Control
- ◆ LDAP / AD / RADIUS Support
- ◆ Backup & Restore Configuration
- ◆ Remote BIOS/BMC/CPLD Update
- ◆ Event Log Filter
- ◆ User Management
- ◆ Media Redirection Settings
- ◆ PAM Order Settings
- ◆ SSL Settings
- ◆ SMTP Settings



Operating Properties

- ◆ Operating temperature: 10°C to 30°C
- ◆ Operating humidity: 8%-80% (non-condensing)
- ◆ Non-operating temperature: -40°C to 60°C
- ◆ Non-operating humidity: 20%-95% (non-condensing)

1-3 System Block Diagram

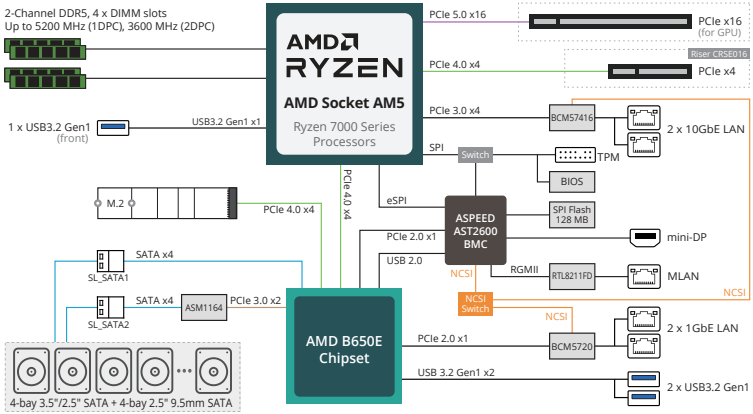

Chapter 2 System Appearance

2-1 Front View

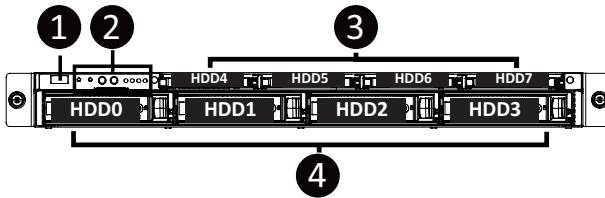

No.	Description
1.	Front USB 3.2 Gen1 Port x 2
2.	Front Panel LEDs and Buttons
3.	2.5" 9.5mm Drive Bays
4.	3.5"/2.5" Drive Bays



- Refer to section **2-3 Front Panel LEDs and Buttons** for a detailed description of the function of the LEDs.

2-2 Rear View

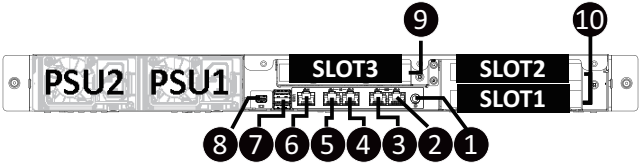

No.	Description
1.	ID Button with LED
2.	10 GbE LAN Port x 2
3.	1 GbE LAN Port x 2
4.	Server Management LAN Port
5.	USB 3.2 Gen1 Port x 2
6.	Mini DP Port
7.	PCIe Card Slot
8.	GPU Card Slot

2-3 Front Panel LED and Buttons

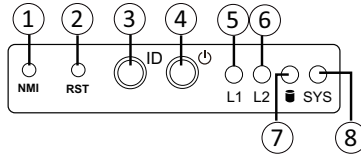

No.	Name	Color	Status	Description
1.	NMI button			Press the button server generates a NMI to the processor if the multiple-bit ECC errors occur, which effectively halt the server.
2.	Reset Button			Press the button to reset the system.
3.	ID Button			Press the button to activate system identification
4.	Power button with LED	Green	On	System is powered on
		Green	Blink	System is in ACPI S1 state (sleep mode)
		N/A	Off	<ul style="list-style-type: none"> System is not powered on or in ACPI S5 state (power off) System is in ACPI S4 state (hibernate mode)
4.	ID Button			Press the button to activate system identification
5/6	LAN 1/2 Active/Link LEDs	Green	Solid On	Link between system and network or no access.
		Green	Blink	Data trasmission or receiving is occuring
		N/A	Off	No data transmission or receiving is occuring
7.	HDD Status LED	Green	On	HDD locate
			Blink	HDD access
		Amber	On	HDD fault
			Blink	HDD rebuilding
		N/A	Off	No HDD access or no HDD fault.
8.	System Status LED	Green	Solid On	System is operating normally.
			Solid On	Critical condition, may indicate: System fan failure System temperature
		Amber	Blink	Non-critical condition, may indicate: Redundant power module failure Temperature and voltage issue Chassis intrusion
			N/A	Off

2-4 Rear System LAN LEDs

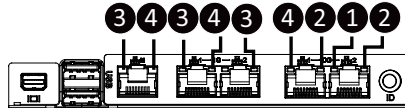

No.	Name	Color	Status	Description
1.	10GbE Speed LED	Green	On	10 Gbps data rate
		Yellow	On	1Gbps data rate
		N/A	Off	100 Mbps data rate
2.	10GbE Link / Activity LED	Green	On	Link between system and network or no access
			Blink	Data transmission or reception is occurring.
		N/A	Off	No data transmission or reception is occurring.
3.	1GbE Speed LED	Yellow	On	1 Gbps data rate
		Green	On	100 Mbps data rate
		N/A	Off	10 Mbps data rate
4.	1GbE Link / Activity LED	Green	On	Link between system and network or no access
			Blink	Data transmission or reception is occurring.
		N/A	Off	No data transmission or reception is occurring.

2-5 Power Supply Unit LED

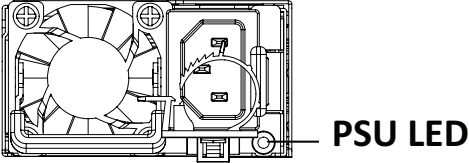

State	Description
OFF	No AC power to all power supplies
1Hz Green Blinking	AC present / only standby on / Cold redundant mode
2Hz Green Blinking	Power supply firmware updateing mode
Amber	AC cord unplugged or AC power lost; with a second power supply in parallel still with AC input power
	Power supply critical event causing shut down: failure, OCP, OVP, fan failure and UVP
1Hz Amber Blinking	Power supply warning events where the power supply continues to operate: high temp, high power, high current and slow fan

2-6 Hard Disk Drive LEDs

3.5" Hard Disk Drive

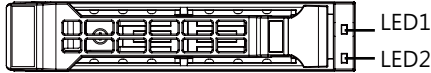

2.5" 9.5mm Hard Disk Drive

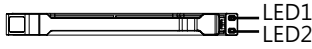

RAID SKU		LED #1	Locate	HDD Fault	Rebuilding	HDD Access	HDD Present (No Access)
No RAID configuration (via HBA)	Disk LED (LED on Back Panel)	Green	ON(*1)	OFF		BLINK (*2)	OFF
		Amber	OFF	OFF		OFF	OFF
	Removed HDD Slot (LED on Back Panel)	Green	ON(*1)	OFF		--	--
		Amber	OFF	OFF		--	--
RAID configuration (via HW RAID Card or SW RAID Card)	Disk LED	Green	ON	OFF		BLINK (*2)	OFF
		Amber	OFF	ON	(Low Speed: 2 Hz)	OFF	OFF
	Removed HDD Slot	Green	ON(*1)	OFF	(*3)	--	--
		Amber	OFF	ON	(*3)	--	--

LED #2	HDD Present	No HDD
Green	ON	OFF

NOTE:

*1: Depends on HBA/Utility Spec.

*2: Blink cycle depends on HDD's activity signal.

*3: If HDD is pulled out during rebuilding, the disk status of this HDD is regarded as faulty.

Chapter 3 System Hardware Installation



Pre-installation Instructions

Computer components and electronic circuit boards can be damaged by discharges of static electricity. Working on computers that are still connected to a power supply can be extremely dangerous. Follow the simple guidelines below to avoid damage to your computer or injury to yourself.

- Always disconnect the computer from the power outlet whenever you are working inside the computer case.
- If possible, wear a grounded wrist strap when you are working inside the computer case. Alternatively, discharge any static electricity by touching the bare metal system of the computer case, or the bare metal body of any other grounded appliance.
- Hold electronic circuit boards by the edges only. Do not touch the components on the board unless it is necessary to do so. Do not flex or stress the circuit board.
- Leave all components inside the static-proof packaging until you are ready to use the component for the installation.

3-1 Removing and Installing the Chassis Cover



Before you remove or install the system cover

- Make sure the system is not turned on or connected to AC power.

Follow these instructions to remove the chassis cover:

1. Remove the screws on both sides of the back chassis cover. (**Note: For safe shipping, installation screws are added and should be removed before deployment/putting it in the server cabinet.**)
2. Remove the screw securing the back chassis cover.
3. Push button to unlock the handle.
4. Pull the grip handle to open the panel cover.
5. Slide the back chassis cover towards the rear and remove the chassis cover in the direction indicated.
6. Remove the screws securing the front chassis cover.
7. Slide the front chassis cover towards the rear and remove the chassis cover in the direction indicated.
8. To reinstall the chassis cover reverse steps 2-7.

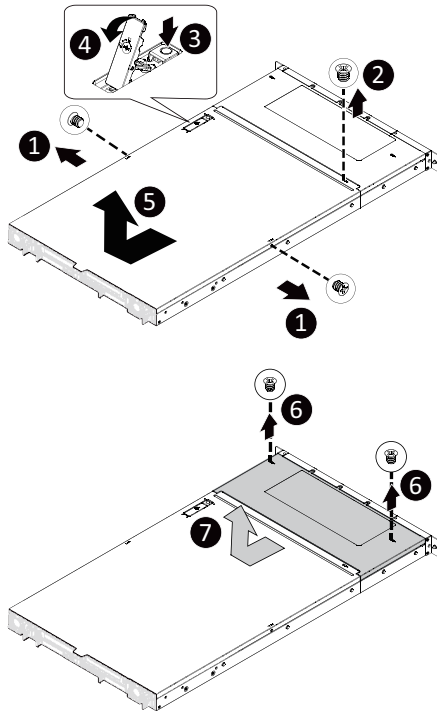

3-2 Removing and Installing the Hard Disk Drive



Read the following guidelines before you begin to install the hard disk drive:

- Take note of the HDD tray orientation before sliding it out.
- The tray will not fit back into the bay if it is inserted incorrectly.
- Make sure that the hard disk drive is connected to the connector on the backplane.

Follow these instructions to install a 3.5" hard disk drive:

1. Press the release button.
2. Extend the locking lever.
3. Pull the locking lever in the direction indicated to remove the 3.5" HDD tray.
4. Pull the sides of the HDD tray in the direction indicated.
5. Slide the hard disk drive into the HDD tray.
6. Push the sides of the HDD tray back in the direction indicated to secure the hard disk drive in place.
7. Reinsert the HDD tray into the slot and close the locking lever.

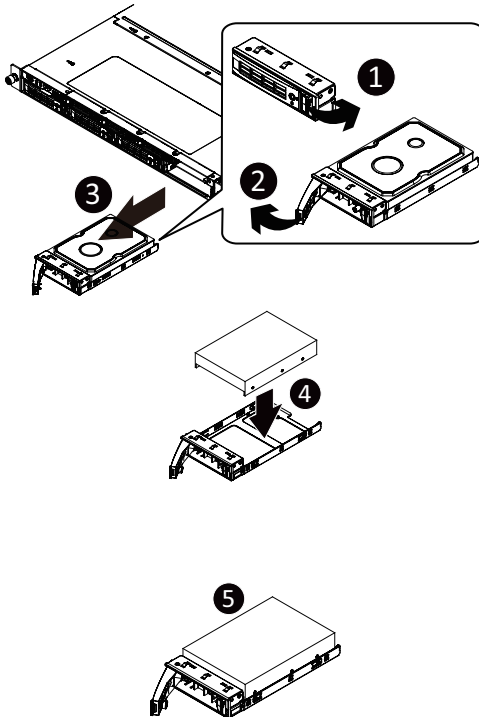

Follow these instructions to install a 2.5" hard disk drive into 3.5" HDD Tray:

1. Press the release button.
2. Extend the locking lever.
3. Pull the locking lever in the direction indicated to remove the HDD tray.
4. Align the hard disk drive with the positioning screw on the HDD tray.
5. Secure the hard disk drive with five screws.
6. Reinsert the HDD tray into the slot and close the locking lever

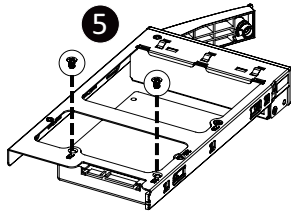
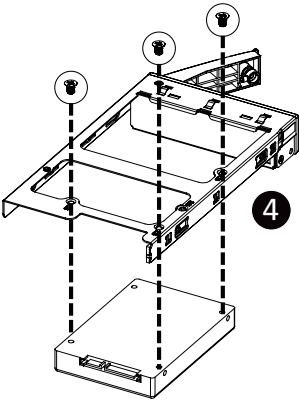
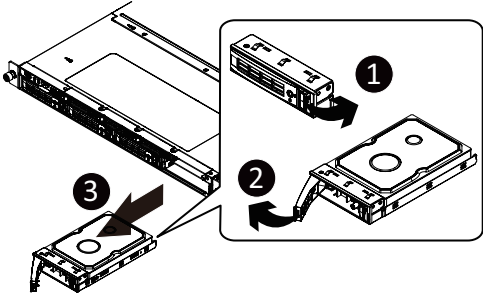

Follow these instructions to install a 2.5" HDD:

1. Press the release button.
2. Extend the locking lever.
3. Pull the locking lever in the direction indicated to remove the HDD tray.
4. Align the hard disk drive with the positioning stud on the HDD tray.
5. Slide the hard disk drive into the HDD tray.
6. Reinsert the HDD tray into the slot and close the locking lever

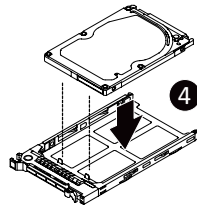
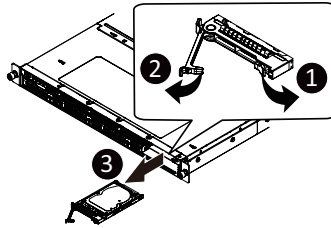

3-3 Removing and Installing the Fan Duct

Follow these instructions to remove the fan duct:

1. Lift up to remove the fan duct.
2. To reinstall the fan duct, align the fan duct with the guiding groove. Push down the fan duct until it is firmly seated on the system.

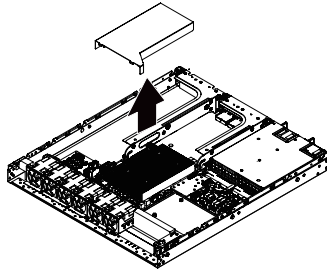

3-4 Removing and Installing the Heat Sink



Read the following guidelines before you begin to install the heat sink:

- Always turn off the computer and unplug the power cord from the power outlet before installing the heat sink to prevent hardware damage.
- Unplug all cables from the power outlets.
- Disconnect all telecommunication cables from their ports.
- Place the system unit on a flat and stable surface.
- Open the system according to the instructions.



WARNING!

Failure to turn off the server before you start installing components may cause serious damage. Do not attempt the procedures described in the following sections unless you are a qualified service technician.

Follow these instructions to install the heat sink:

1. Loosen the screws securing the heat sink in place in reverse order (4→3→2→1).
2. Lift and remove the heat sink from the system.
3. To install the heat sink, reverse steps 1-2 while ensuring that you tighten the captive screws in sequential order (1→2→3→4) as seen in the image below.

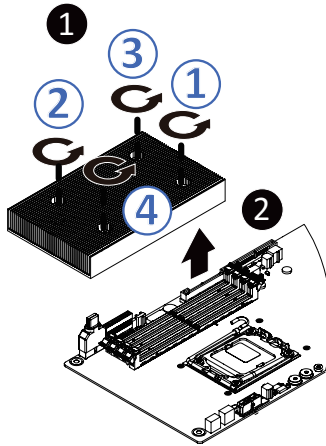

3-5 Removing and Installing the CPU and Heat sink



Read the following guidelines before you begin to install the CPU:

- Make sure that the motherboard supports the CPU.
- Always turn off the computer and unplug the power cord from the power outlet before installing the CPU to prevent hardware damage.
- Unplug all cables from the power outlets.
- Disconnect all telecommunication cables from their ports.
- Place the system unit on a flat and stable surface.
- Open the system according to the instructions.



WARNING!

Failure to properly turn off the server before you start installing components may cause serious damage. Do not attempt the procedures described in the following sections unless you are a qualified service technician.

Follow these instructions to install the CPU:

1. Gently press the CPU socket lever handle down and away from the socket. Lift up the CPU socket locking lever and then open the CPU cover.
2. Align the CPU pin one (triangle marking) with the pin one corner of the CPU socket. Install the CPU onto the socket.
3. Ensure the CPU is positioned into its socket and then close the CPU cover. Secure the CPU socket lever under its retention tab. The plastic protective cover will pop off by itself and can be removed
NOTE: Always replace the plastic protective cover when the CPU is not installed to protect the CPU socket.
4. Align and place the heatsink onto the top of the CPU socket.
5. To secure the heatsink, tighten the four screws to the CPU socket.
6. To remove the heatsinks and CPUs, follow steps 1-5 in reverse order.

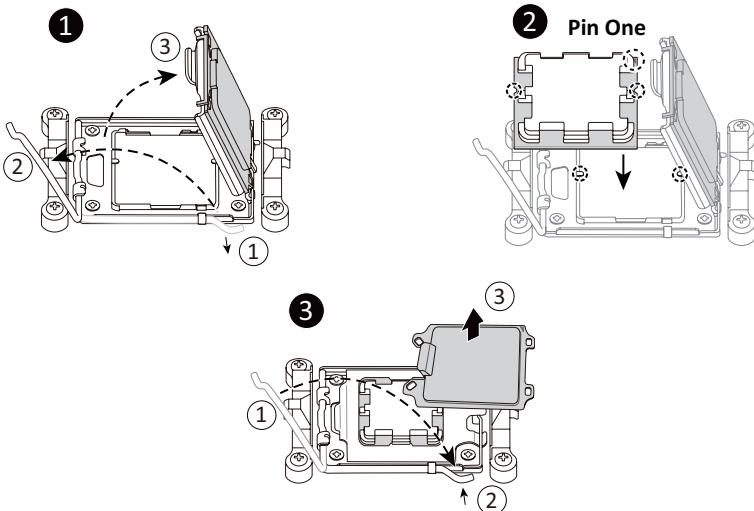

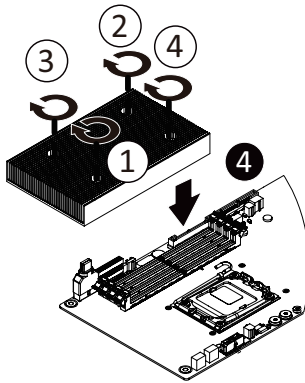

- Lock the CPU by using a Torx T20 screwdriver to tighten screw.
- When installing the heatsink to CPU, use a Torx T20 screwdriver to tighten 4 captive nuts in sequence as 1-4.
- The screw tightening torque: 13.5 ± 0.5 kgf-cm.
- To ensure the system operates properly, make sure the heatsink is seated on the processor firmly.

3-6 Removing and Installing Memory



Read the following guidelines before you begin to install the memory:

- Make sure that the motherboard supports the memory. It is recommended that memory of the same capacity, brand, speed, and chips be used.
- Always turn off the computer and unplug the power cord from the power outlet before installing the memory to prevent hardware damage.
- Memory modules have a foolproof design. A memory module can be installed in only one direction. If you are unable to insert the memory, switch the direction.

3-6-1 Dual Channel Memory Configuration

This motherboard provides 4 DDR5 memory sockets and supports Dual Channel Technology. After the memory is installed, the BIOS will automatically detect the specifications and capacity of the memory.

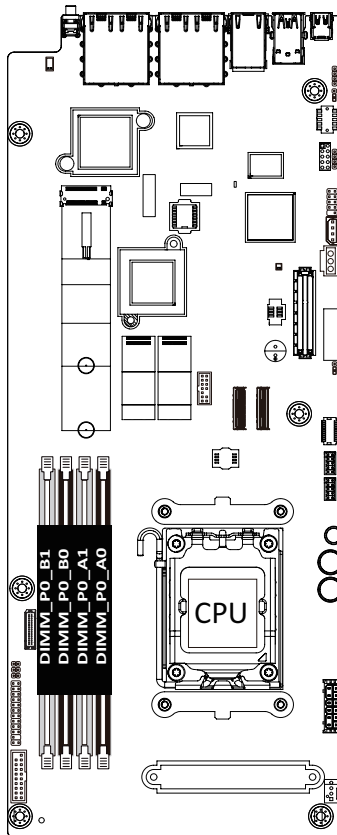

3-6-2 Removing and Installing a Memory Module



Before installing a memory module, make sure to turn off the computer and unplug the power cord from the power outlet to prevent damage to the memory module. Be sure to install DDR5 DIMMs on to this motherboard.

Follow these instructions to install a DIMM module:

1. Insert the DIMM memory module vertically into the DIMM slot and push it down.
2. Close the plastic clip at both edges of the DIMM slots to lock the DIMM module.
3. Reverse the installation steps when you want to remove the DIMM module.

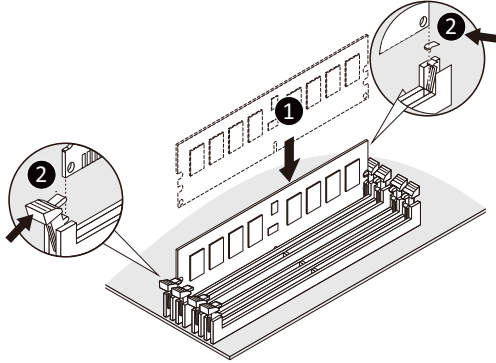

3-6-3 Memory Module Population Table

Memory Type	DDR5	
Voltage (V)	5V	
Connector	UDIMM ECC/Non-ECC	
Speed (MT/s)	5200	3600
Channels	1,2	
DIMM Per Channel	1,2	
DIMM Capacity (GB)	2,4,8,16,32	



Note:

- When only one DIMM is used, it must be populated in memory slot A1.

3-7 Removing and Installing the PCIe Card



- Voltages can be present within the server whenever an AC power source is connected. This voltage is present even when the main power switch is in the off position. Ensure that the system is powered off and all power sources have been disconnected from the server prior to installing a PCIe card.
- Failure to observe these warnings could result in personal injury or damage to equipment.



- The PCIe riser assembly does not include a riser card or any cabling as standard. To install a PCIe card, a riser card must be installed.

Follow these instructions to install a PCIe card:

1. Loosen the thumbnail screw securing the riser bracket inside the system. Remove the two bracket screws securing the riser bracket .
 2. Lift up the riser bracket out of system.
 3. Remove the screw securing the slot cover from riser bracket.
 4. Orient the PCIe card with the riser guide slot and push in the direction of the arrow until the PCIe card sits in the PCIe card connector.
- NOTE:** Some riser brackets allow for single or multiple PCIe cards.
Repeat steps 3-4 as necessary.
5. Secure the PCIe card with the screw.
 6. Repeat steps 1-2 to install the PCIe card into the system.

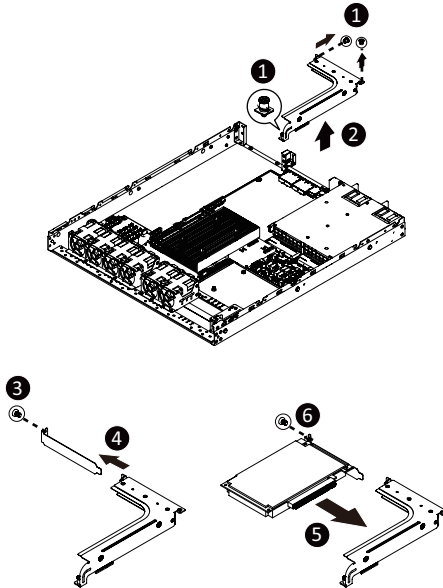

3-8 Installing the GPU Card (Optional)



Before you install the GPU card:

- Voltages can be present within the server whenever an AC power source is connected. This voltage is present even when the main power switch is in the off position. Ensure that the system is powered down and all power sources have been disconnected from the server prior to installing a GPU card. Make sure the system is not turned on or connected to AC power.
- Failure to observe these warnings could result in personal injury or damage to the equipment.

Follow these instructions to install the GPU card:

1. Loosen the thumbnail screw securing the riser bracket inside the system. Remove the two screws securing the GPU card bracket in place.
2. Lift the GPU card bracket up in the direction indicated as shown in the image below.
3. Remove the two screws securing the GPU card slot covers and remove the GPU slot covers.
4. Insert the GPU card into the selected slot. Make sure the GPU card is properly seated.
5. Install the two screws to secure the GPU card in place.
6. Install the three screws to secure the GPU card bracket in place.

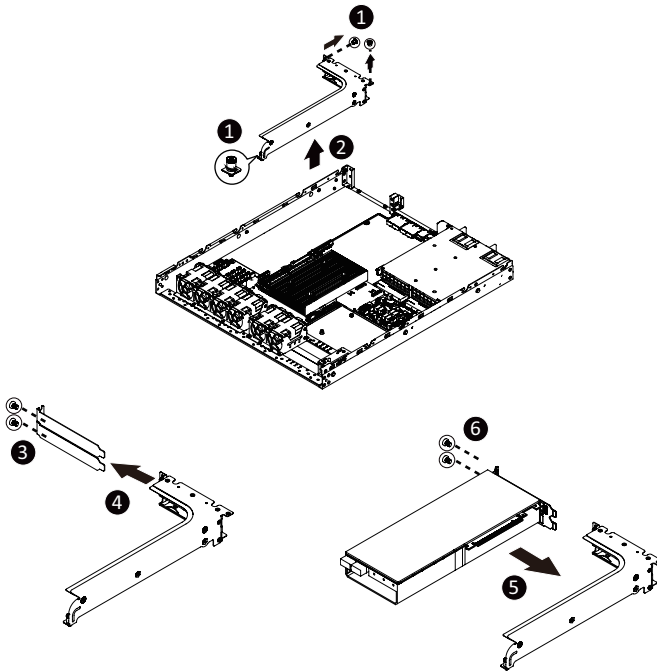

3-9 Installing the M.2 Device and Heat Sink



CAUTION

The position of the stand-off screw will depend on the size of the M.2 device. The stand-off screw is pre-installed for 22110 cards as standard. Refer to the size of the M.2 device and change the position of the stand-off screw accordingly.

Follow these instructions to install the M.2 device:

1. Insert the M.2 SSD module into the slot.
2. Secure it with the screw, tightening as necessary to fasten the M.2 SSD module in place.

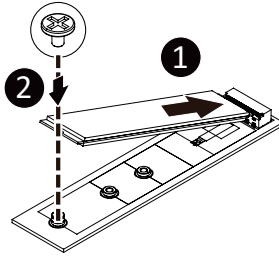

3-10 Removing and Installing the Power Supply

Follow these instructions to replace the power supply:

1. Flip up and then grasp the power supply handle.
2. Press the retaining clip on the right side of the power supply unit in the direction indicated.
3. Pull out the power supply unit using the handle.
4. Insert the replacement power supply unit firmly into the chassis. Connect the AC power cord to the replacement power supply.
5. Repeat steps 1-4 for replacement of the second power supply.

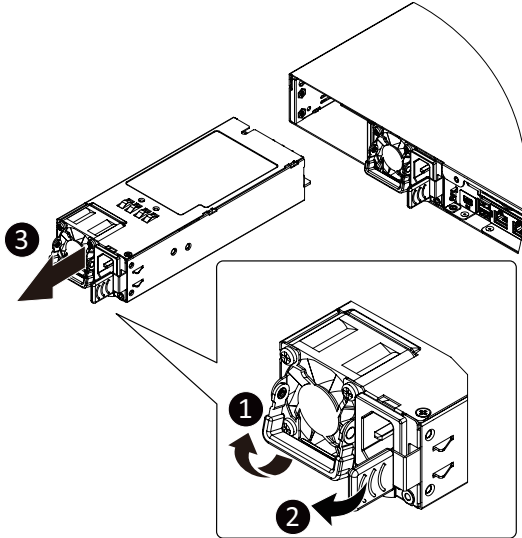

3-11 Cable Routing

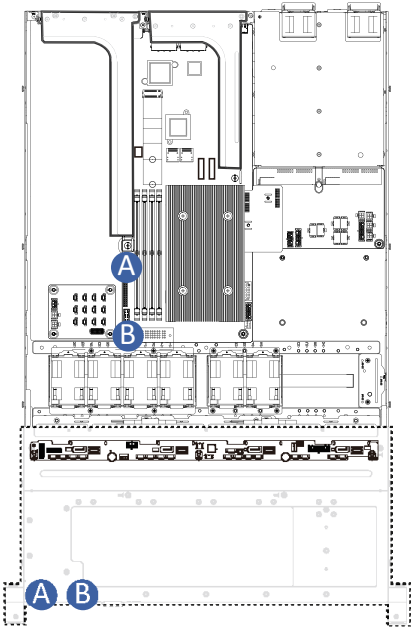

A	Front Panel LEDs and Buttons Cable	Motherboard: FP_1
		Front IO Board: FP_1
B	Front Panel USB 3 Ports Cable	Motherboard: FUSB_1
		--

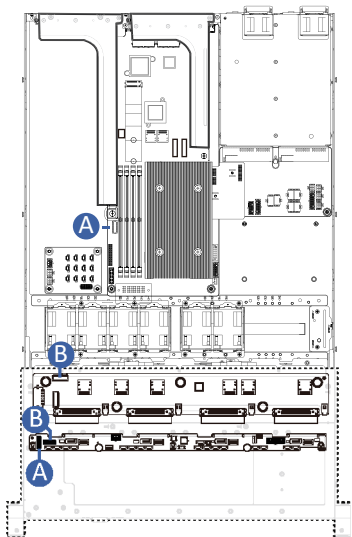

A	HDD Backplane Board Signal Cable (CBP1047)	Motherbord: BP_1
		F/ HDD Board: BP_1
B	HDD Backplane Board Signal Cable (CBP1045)	F/ HDD Board (CBP1047): BP_Series
		F/ HDD Board (CBP1045): BP_1

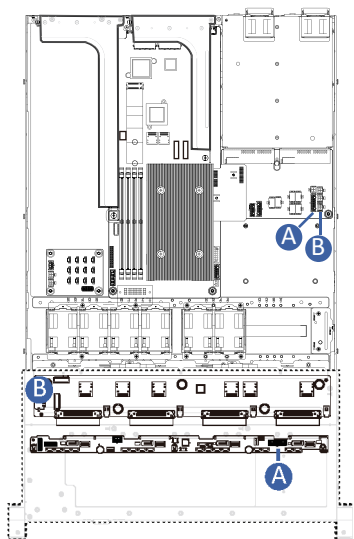

A	HDD Backplane Board Power Cable (CBP1047)	Power Board: BP_ATX1
		F/ HDD Board: BP_2X7
B	HDD Backplane Board Power Cable (CBP1045)	Power Board: BP_ATX2
		F/ HDD Board: BP_2X7

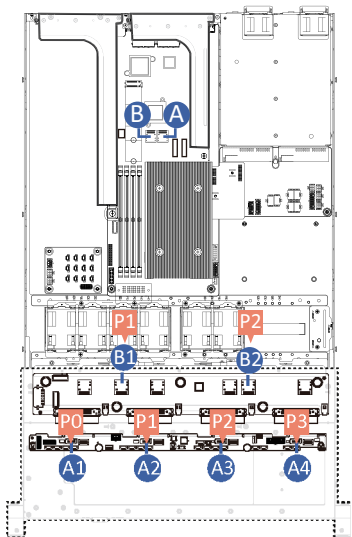

A	SATA Cable	Motherboard: SATA/SL_SATA1
		F/ HDD Board (CBP1047): A1: SATA0 A2: SATA1 A3: SATA2 A4: SATA3
B	SATA Cable	Motherboard: SATA/SL_SATA2
		F/ HDD Board (CBP1045): B1: SATA0_1 B2: SATA2_3

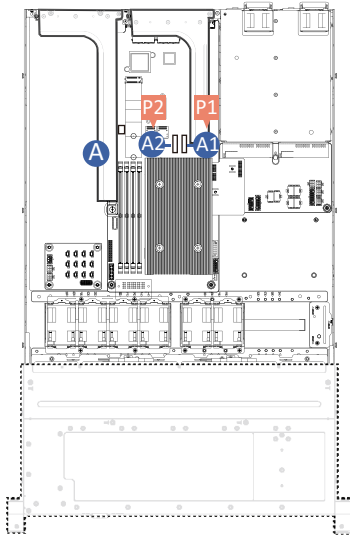

A	GPU Cable	Riser Side
		Motherboard A1: U2_P0_P0A A2: U2_P0_P0B

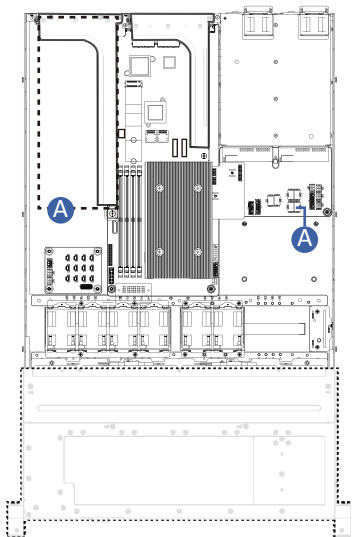

A	GPU Power Cable	GPU Card Power Connector
		Power Board: P12V_GPU5

Chapter 4 Motherboard Components

4-1 Motherboard Components

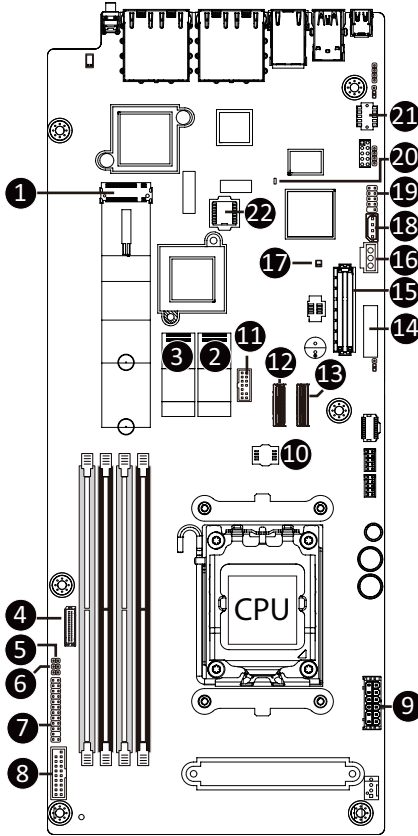

Item	Description
1	M.2 Slot (PCIe Gen4 x4, Support NGFF-22210/2280)
2	SlimLine Connector (SATA/SL_SATA1)
3	SlimLine Connector (SATA/SL_SATA2)
4	HDD Backplane Board Connector
5	10G LAN Active LED Header (10GACT1)
6	10G LAN Active LED Header (10GACT2)
7	Front Panel Connector
8	Front Panel USB 3.2 Gen1 Connector
9	2 x 6 Pin Main Power Connector

Item	Description
10	BIOS Flash ROM
11	TPM Module Connector
12	MCIO Connector (U2_P0_P0B)
13	MCIO Connector (U2_P0_P0A)
14	System Battery Socket
15	PCIe x4 Slot (Gen4 x4)
16	BMC USB2B
17	USB Select Switch
18	IPMB Connector
19	Front USB 2.0 Cable Connector
20	BMC Firmware Readiness LED
21	Serial Port Cable Connector
22	BMC Flash ROM

4-2 Jumper Settings

NCSI Switch



SW1	SW2	Mode
OFF	OFF	BCM5720
OFF	ON	BCM57416
ON	OFF	CN_NCSI
ON	ON	CN_NCSI

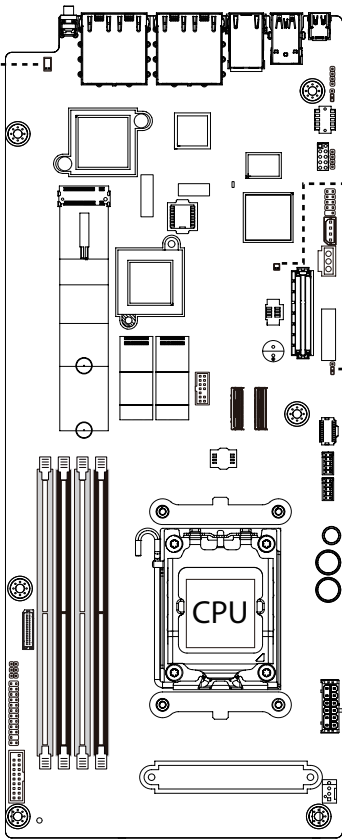

USB Select Switch



USB_SEL	Mode
ON	ASPEED
OFF	PCH

**Clear CMOS
CLR_CMOS**



1 } Default
2 } Enable
3 }

4-3 Backplane Board Storage Connector

4-3-1 CBP1047

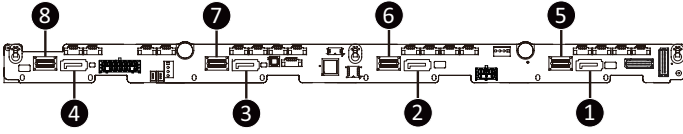

Item	Description
1	SATA Connector (SATA0)
2	2 SATA Connector (SATA1)
3	3 SATA Connector (SATA2)
4	4 SATA Connector (SATA3)
5	5 SlimLine Connector (SFF-8654 4i/U.2_0)
6	6 SlimLine Connector (SFF-8654 4i/U.2_1)
7	7 SlimLine Connector (SFF-8654 4i/U.2_2)
8	8 SlimLine Connector (SFF-8654 4i/U.2_3)

4-3-2 CBP1045

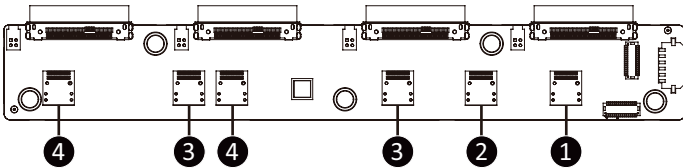

Item	Description
1	SlimLine Connector (SFF-8654 4i/U.2_0)
2	2 SlimLine Connector (SFF-8654 4i/SATA0_1)
3	3 SlimLine Connector (SFF-8654 4i/U.2_1)
4	4 SlimLine Connector (SFF-8654 4i/U.2_2)
5	5 SlimLine Connector (SFF-8654 4i/SATA2_3)
6	6 SlimLine Connector (SFF-8654 4i/U.2_3)

Chapter 5 BIOS Setup

BIOS (Basic Input and Output System) records hardware parameters of the system in the EFI on the motherboard. Its major functions include conducting the Power-On Self-Test (POST) during system startup, saving system parameters, loading the operating system etc. The BIOS includes a BIOS Setup program that allows the user to modify basic system configuration settings or to activate certain system features. When the power is turned off, the battery on the motherboard supplies the necessary power to the CMOS to keep the configuration values in the CMOS.

To access the BIOS Setup program, press the key during the POST when the power is turned on.



- BIOS flashing is potentially risky, if you do not encounter any problems when using the current BIOS version, it is recommended that you don't flash the BIOS. To flash the BIOS, do it with caution. Inadequate BIOS flashing may result in system malfunction.
- It is recommended that you not alter the default settings (unless you need to) to prevent system instability or other unexpected results. Inadequately altering the settings may result in system's failure to boot. If this occurs, try to clear the CMOS values and reset the board to default values. (Refer to the **Exit** section in this chapter or introductions of the battery/clearing CMOS jumper in Chapter 4 for how to clear the CMOS values.)

BIOS Setup Program Function Keys

<<-><->>	Move the selection bar to select the screen
<↑><↓>	Move the selection bar to select an item
<+>	Increase the numeric value or make changes
<->	Decrease the numeric value or make changes
<Enter>	Execute command or enter the submenu
<Esc>	Main Menu: Exit the BIOS Setup program Submenus: Exit current submenu
<F1>	Show descriptions of general help
<F3>	Restore the previous BIOS settings for the current submenus
<F9>	Load the Optimized BIOS default settings for the current submenus
<F10>	Save all the changes and exit the BIOS Setup program

■ **Main**

This setup page includes all the items of the standard compatible BIOS.

■ **Advanced**

This setup page includes all the items of AMI BIOS special enhanced features.

(ex: Auto detect fan and temperature status, automatically configure hard disk parameters.)

■ **Chipset**

This setup page includes all the submenu options for configuring the functions of the North Bridge.

■ **Server Management**

Server additional features enabled/disabled setup menus.

■ **Security**

Change, set, or disable supervisor and user password. Configuration supervisor password allows you to restrict access to the system and BIOS Setup.

A supervisor password allows you to make changes in BIOS Setup.

A user password only allows you to view the BIOS settings but not to make changes.

■ **Boot**

This setup page provides items for configuration of the boot sequence.

■ **Save & Exit**

Save all the changes made in the BIOS Setup program to the CMOS and exit BIOS Setup. (Pressing <F10> can also carry out this task.)

Abandon all changes and the previous settings remain in effect. Pressing <Y> to the confirmation message will exit BIOS Setup. (Pressing <Esc> can also carry out this task.)

5-1 The Main Menu

Once you enter the BIOS Setup program, the Main Menu (as shown below) appears on the screen. Use arrow keys to move among the items and press <Enter> to accept or enter other sub-menu.

Main Menu Help

The on-screen description of a highlighted setup option is displayed on the bottom line of the Main Menu.

Submenu Help

While in a submenu, press <F1> to display a help screen (General Help) of function keys available for the menu. Press <Esc> to exit the help screen. Help for each item is in the Item Help block on the right side of the submenu.



- When the system is not stable as usual, select the **Restore Defaults** item to set your system to its defaults.
- The BIOS Setup menus described in this chapter are for reference only and may differ by BIOS version.

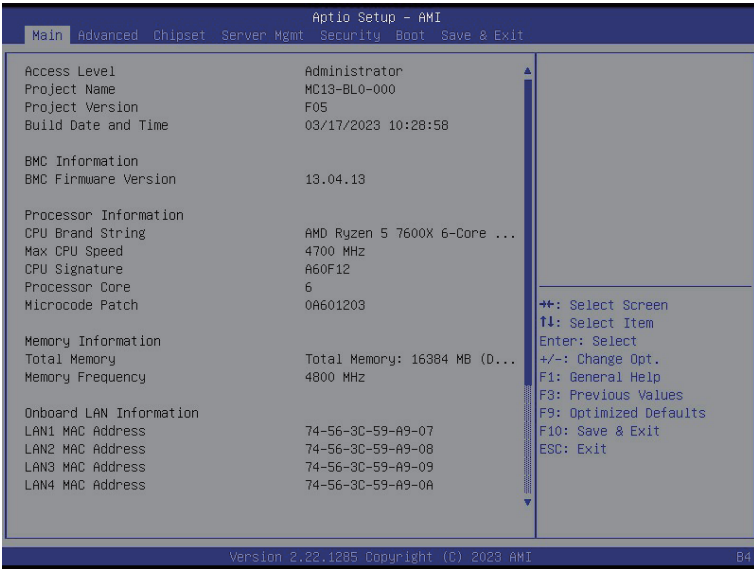

(Note) The model name will vary depends on the product you purchased

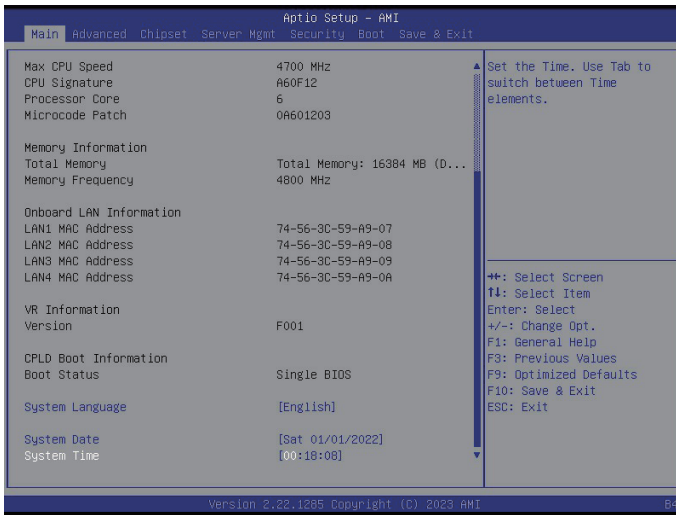

Parameter	Description
Access Level	Displays the privileges level information.
Project Name	Displays the project name information.
Project Version	Displays version number of the BIOS setup utility.
Build Date and Time	Displays the date and time when the BIOS setup utility was created.
BMC Information	
BMC Firmware Version	Displays BMC firmware version information.
Memory Information	
Total Memory ^(Note1)	Displays the total memory size of the installed memory.
Memory Frequency ^(Note1)	Displays the frequency information of the installed memory.
Onboard LAN Information	
LAN# MAC Address ^(Note2)	Displays LAN MAC address information.
VR Information Version	Displays VR version information.
CPLD Boot Information	
Boot Status	Displays CPLD boot information.
System Language	Default setting is English.
System Date	Sets the date following the weekday-month-day-year format.
System Time	Sets the system time following the hour-minute-second format.

(Note1) This section will display capacity and frequency information of the memory that the customer has installed.

(Note2) The number of LAN ports listed will depend on the motherboard / system model.

5-2 Advanced Menu

The Advanced Menu displays submenu options for configuring the function of various hardware components. Select a submenu item, then press <Enter> to access the related submenu screen.

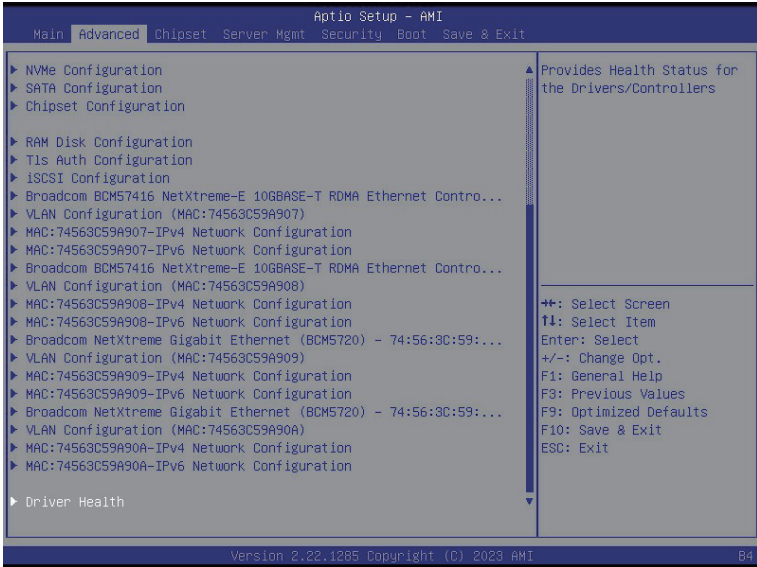
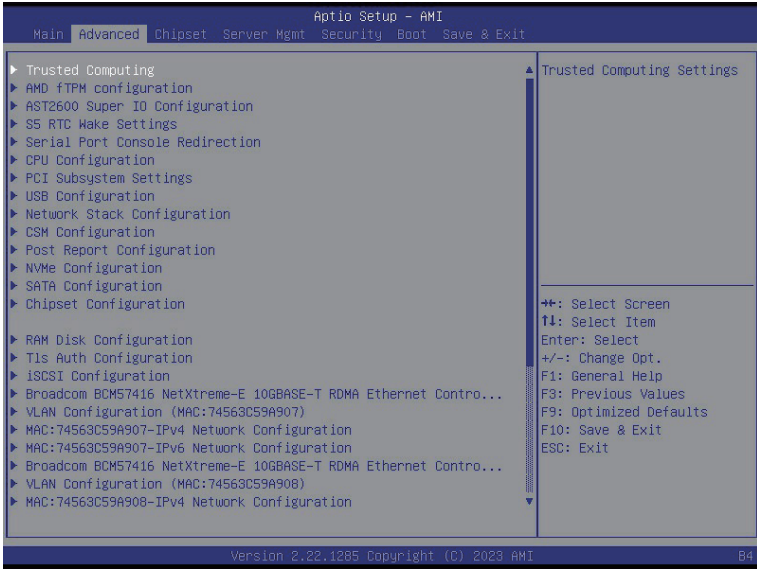

5-2-1 Trusted Computing

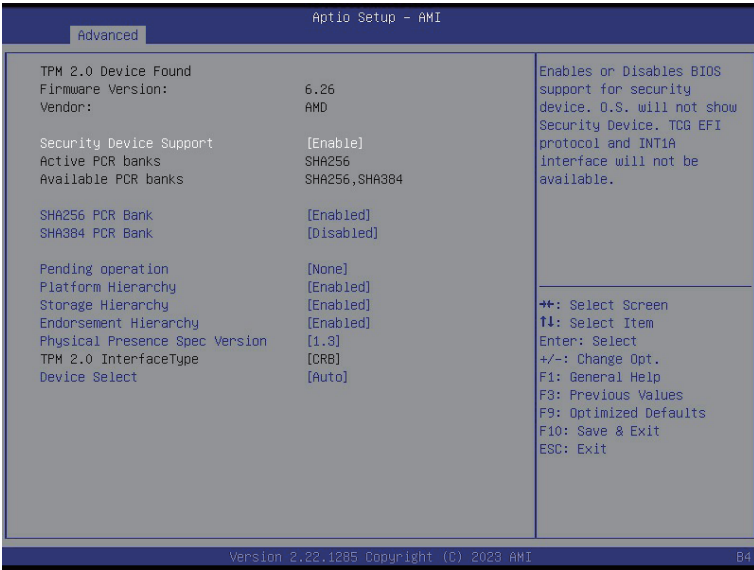

Parameter	Description
TPM20 Device Found	
Firmware Version	Displays the firmware version information.
Vendor	Displays the vendor information.
Security Device Support	Enable/Disable BIOS support for security device. OS will not show security device. TCG EFI protocol and INT1A interface will not be available. Options available: Disable, Enable. Default setting is Enable .
Active PCR banks	Displays active Platform Configuration Register (PCR) banks.
Available PCR banks	Displays available PCR banks.
SHA256 PCR Bank	Enable/Disable SHA256 PCR bank. Options available: Disabled, Enabled. Default setting is Enabled .
SHA-384 PCR Bank	Enable/Disable SHA-384 PCR bank. Options available: Disabled, Enabled. Default setting is Disabled .
Pending operation	Schedule an operation for the security device. NOTE: Your computer will reboot during restart in order to change the state of a security device. Options available: None, TPM Clear. Default setting is None .

Parameter	Description
Platform Hierarchy	Enable/Disable platform hierarchy. Options available: Disabled, Enabled. Default setting is Enabled .
Storage Hierarchy	Enable/Disable storage hierarchy. Options available: Disabled, Enabled. Default setting is Enabled .
Endorsement Hierarchy	Enable/Disable endorsement hierarchy. Options available: Disabled, Enabled. Default setting is Enabled .
Physical Presence Spec Version	Selects the physical presence spec version. Options available: 1.2, 1.3. Default setting is 1.3 .
TPM 20 InterfaceType	Displays the TPM 2.0 interface type.
Device Select	Options available: TPM 1.2, TPM 2.0, Auto. Default setting is Auto .

5-2-2 AMD fTPM Configuration



Parameter	Description
AMD fTPM switch	Options available: AMD CPU fTPM, AMD CPU HSP, Route to SPI TPM. Default setting is AMD CPU fTPM .
Erase fTPM NV for factory reset	Options available: Disabled, Enabled. Default setting is Enabled .

5-2-3 AST2600 Super IO Configuration

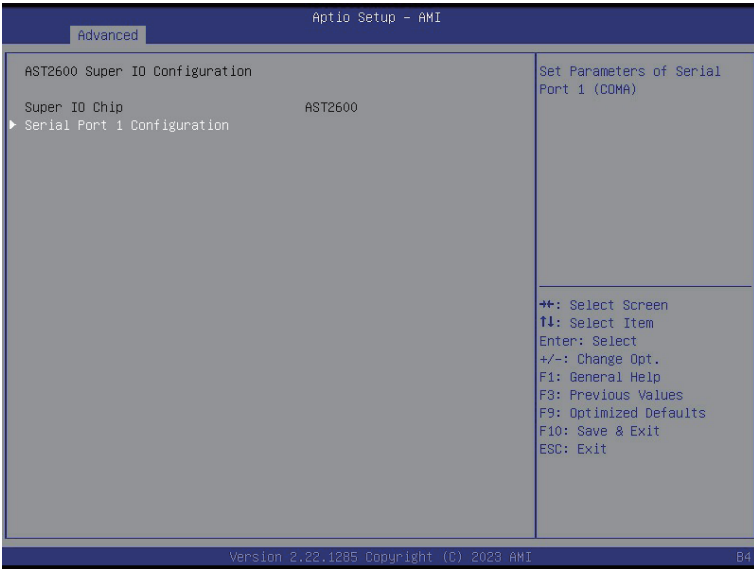

Parameter	Description
AST2600 Super IO Configuration	
Super IO Chip	Displays the super IO chip information
Serial Port 1 Configuration	Press [Enter] for configuration of advanced items.

5-2-3-1 Serial Port 1 Configuration

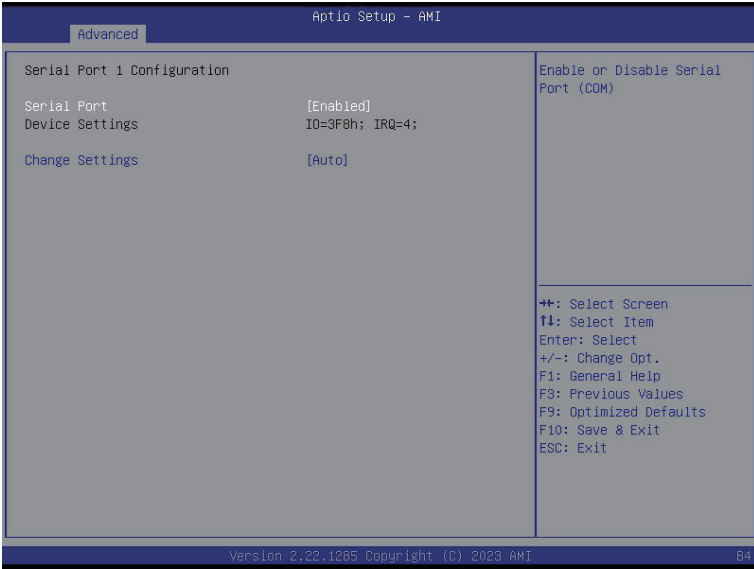

Parameter	Description
Serial Port 1 Configuration	
Serial Port ^(Note)	Enable/Disable the Serial Port (COM). When set to Enabled allows you to configure the Serial port 1 settings. When set to Disabled, displays no configuration for the serial port. Options available: Disabled, Enabled. Default setting is Enabled .
Devices Settings	Displays the Serial Port 1 device settings.
Change Settings	Select an optimal settings for Super IO Device. Options available for Serial Port 1: Auto IO=3F8h; IRQ=4; IO=3F8h; IRQ=3, 4, 5, 6, 7, 9, 10, 11, 12; IO=2F8h; IRQ=3, 4, 5, 6, 7, 9, 10, 11, 12; IO=3E8h; IRQ=3, 4, 5, 6, 7, 9, 10, 11, 12; IO=2E8h; IRQ=3, 4, 5, 6, 7, 9, 10, 11, 12; Default setting is Auto .

(Note) Advanced items prompt when this item is defined.

5-2-4 S5 RTC Wake Settings



Parameter	Description
Wake System from S5	<p>Enable/Disable system wake on alarm event.</p> <p>Options available: Disabled, Fixed Time. When Fixed Time is selected, system will wake on the hr::min::sec specified.</p> <p>Default setting is Disabled.</p>

5-2-5 Serial Port Console Redirection

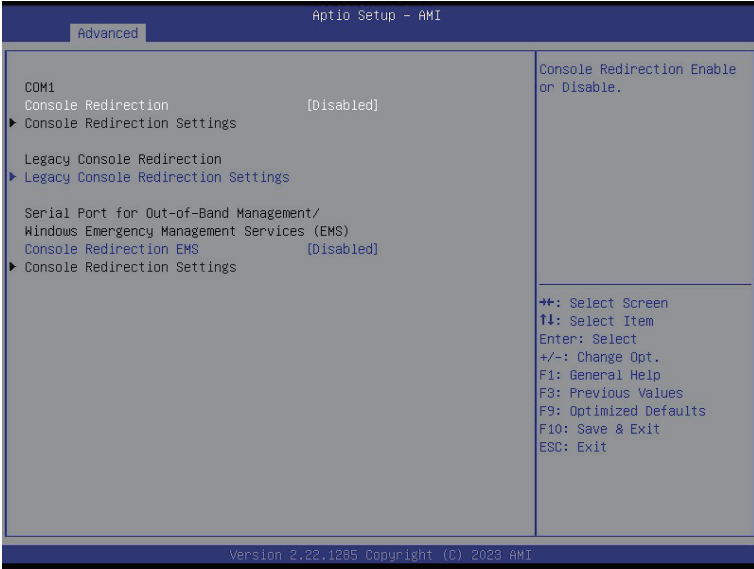

Parameter	Description
COM Console Redirection ^(Note)	<p>Select whether to enable console redirection for specified device. Console redirection enables the users to manage the system from a remote location.</p> <p>Options available: Disabled, Enabled. Default setting is Disabled.</p>
COM Console Redirection Settings	<p>Press [Enter] to configure advanced items.</p> <p>Please note that this item is configurable when COM Console Redirection is set to Enabled.</p> <ul style="list-style-type: none"> ◆ Terminal Type <ul style="list-style-type: none"> – Selects a terminal type to be used for console redirection. – Options available: VT100, VT100Plus, VT-UTF8, ANSI. Default setting is ANSI. ◆ Bits per second <ul style="list-style-type: none"> – Selects the transfer rate for console redirection. – Options available: 9600, 19200, 38400, 57600, 115200. Default setting is 115200. ◆ Data Bits <ul style="list-style-type: none"> – Selects the number of data bits used for console redirection. – Options available: 7, 8. Default setting is 8.

(Note) Advanced items prompt when this item is defined.

Parameter	Description
COM Console Redirection Settings (continued)	<ul style="list-style-type: none"> ◆ Parity <ul style="list-style-type: none"> – A parity bit can be sent with the data bits to detect some transmission errors. – Even: parity bit is 0 if the num of 1's in the data bits is even. – Odd: parity bit is 0 if num of 1's in the data bits is odd. – Mark: parity bit is always 1. Space: Parity bit is always 0. – Mark and Space Parity do not allow for error detection. – Options available: None, Even, Odd, Mark, Space. Default setting is None. ◆ Stop Bits <ul style="list-style-type: none"> – Stop bits indicate the end of a serial data packet. (A start bit indicates the beginning). The standard setting is 1 stop bit. Communication with slow devices may require more than 1 stop bit. – Options available: 1, 2. Default setting is 1. ◆ Flow Control <ul style="list-style-type: none"> – Flow control can prevent data loss from buffer overflow. When sending data, if the receiving buffers are full, a 'stop' signal can be sent to stop the data flow. Once the buffers are empty, a 'start' signal can be sent to re-start the flow. Hardware flow control uses two wires to send start/stop signals. – Options available: None, Hardware RTS/CTS. Default setting is None. ◆ VT-UTF8 Combo Key Support <ul style="list-style-type: none"> – Enable/Disable the VT-UTF8 Combo Key Support. – Options available: Disabled, Enabled. Default setting is Enabled. ◆ Recorder Mode <ul style="list-style-type: none"> – When this mode enabled, only texts will be send. This is to capture Terminal data. – Options available: Disabled, Enabled. Default setting is Disabled. ◆ Resolution 100x31 <ul style="list-style-type: none"> – Enable/Disable extended terminal resolution. – Options available: Disabled, Enabled. Default setting is Disabled. ◆ Putty Keypad <ul style="list-style-type: none"> – Selects FunctionKey and Keypad on Putty. – Options available: VT100, LINUX, XTERMR6, SC0, ESCN, VT400. Default setting is VT100.

Parameter	Description
Legacy Console Redirection	
Legacy Console Redirection Settings	<p>Press [Enter] to configure advanced items.</p> <ul style="list-style-type: none"> ◆ Redirection COM Port <ul style="list-style-type: none"> – Selects a COM port for Legacy serial redirection. – Default setting is COM1. ◆ Resolution <ul style="list-style-type: none"> – Selects the number of rows and columns used in Console Redirection for legacy OS support. – Options available: 80x24, 80x25. Default setting is 80x24. ◆ Redirect After POST <ul style="list-style-type: none"> – When Bootloader is selected, then Legacy Console Redirection is disabled before booting to legacy OS. When Always Enable is selected, then Legacy Console Redirection is enabled for legacy OS. – Options available: Always Enable, BootLoader. Default setting is Always Enable.
Serial Port for Out-of-Band Management / Windows Emergency Management Services (EMS) Console Redirection ^(Note)	<p>EMS console redirection allows the user to configure Console Redirection Settings to support Out-of-Band Serial Port management.</p> <p>Options available: Disabled, Enabled. Default setting is Disabled.</p>
Serial Port for Out-of-Band EMS Console Redirection Settings	<p>Press [Enter] to configure advanced items.</p> <p>Please note that this item is configurable when Serial Port for Out-of-Band Management EMS Console Redirection is set to Enabled.</p> <ul style="list-style-type: none"> ◆ Out-of-Band Mgmt Port <ul style="list-style-type: none"> – Microsoft Windows Emergency Management Service (EMS) allows for remote management of a Windows Server OS through a serial port. – Default setting is COM1. ◆ Terminal Type EMS <ul style="list-style-type: none"> – Selects a terminal type to be used for console redirection. – Options available: VT100, VT100Plus, VT-UTF8, ANSI. Default setting is ANSI. ◆ Bits per second EMS <ul style="list-style-type: none"> – Selects the transfer rate for console redirection. – Options available: 9600, 19200, 38400, 57600, 115200. Default setting is 115200.

(Note) Advanced items prompt when this item is defined.

Parameter	Description
Serial Port for Out-of-Band EMS Console Redirection Settings(continued)	<ul style="list-style-type: none">◆ Flow Control EMS<ul style="list-style-type: none">– Flow control can prevent data loss from buffer overflow. When sending data, if the receiving buffers are full, a 'stop' signal can be sent to stop the data flow. Once the buffers are empty, a 'start' signal can be sent to re-start the flow. Hardware flow control uses two wires to send start/stop signals.– Options available: None, Hardware RTS/CTS, Software Xon/Xoff. Default setting is None.

5-2-6 CPU Configuration

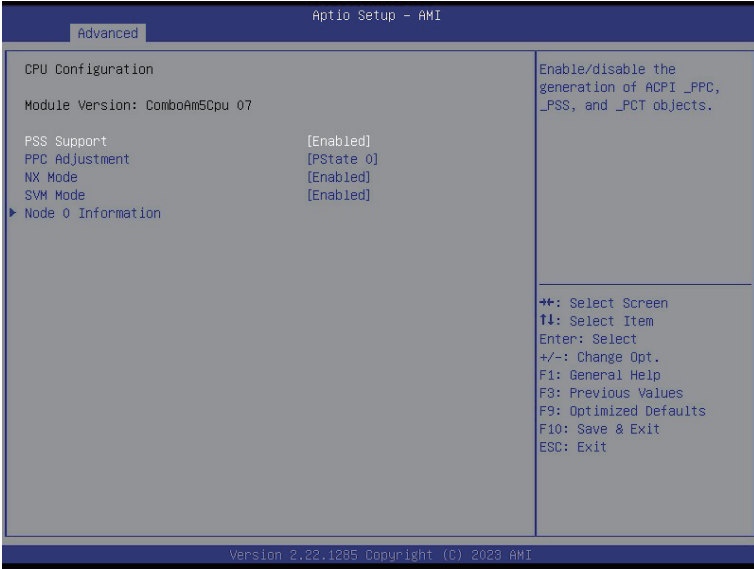

Parameter	Description
CPU Configuration	
Module Version	Displays the module version information.
PSS Support	Enable/Disable the generation of ACPI_PPC, _PSS, and _PCT objects. Options available: Disabled, Enabled. Default setting is Enabled .
PPC Adjustment	Options available: PState 0, PState 1, PState 2, PState 3. Default setting is PState 0 .
NX Mode	Enable/Disable No-execute page protection Function. Options available: Disabled, Enabled. Default setting is Enabled .
SVM Mode	Enable/Disable the CPU Virtualization. Options available: Disabled, Enabled. Default setting is Enabled .
Node 0 Information	Press [Enter] to view the information related to Node 0.

5-2-7 PCI Subsystem Settings



Parameter	Description
PCI BUS Driver Version	Displays PCI BUS driver version information.
PCIE_1 I/O ROM	When enabled, this setting will initialize the device expansion ROM for the related PCI-E slot. Options available: Disabled, Enabled. Default setting is Enabled .
PCIE_1 Lanes	Change the PCIe lanes. Options available: Auto, x16, x8x8, x8x4x4, x4x4x8, x4x4x4x4. Default setting is Auto .
PCIE_1 Max Link Speed	Change the PCIe max link speed. Options available: Auto, Gen1, Gen2, Gen3, Gen4, Gen5. Default setting is Auto .
Onboard LAN# Controller ^(Note)	Enable/Disable the onboard LAN controller. Options available: Disabled, Enabled. Default setting is Enabled .
Onboard LAN# I/O ROM ^(Note)	Enable/Disable the onboard LAN devices, and initializes device expansion ROM. Options available: Disabled, Enabled. Default setting is Enabled .

(Note) This section is dependent on the available LAN controller.

Parameter	Description
Above 4G Decoding	Enable/Disable memory mapped I/O to 4GB or greater address space (Above 4G Decoding). Options available: Disabled, Enabled. Default setting is Enabled .
Re-Size BAR Support	Options available: Disabled, Enabled. Default setting is Enabled .
SR-IOV Support	If the system has SR-IOV capable PCIe devices, this item Enable/Disable Single Root IO Virtualization Support. Options available: Disabled, Enabled. Default setting is Disabled .

5-2-8 USB Configuration

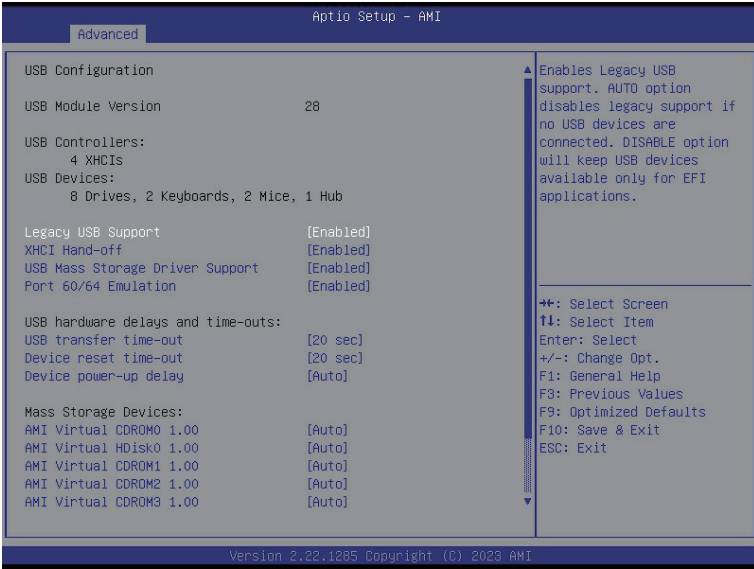

Parameter	Description
USB Configuration	
USB Module Version	Displays the USB module version information.
USB Controllers	Displays the supported USB controllers.
USB Devices:	Displays the USB devices connected to the system.
Legacy USB Support	Enable/Disable the Legacy USB support function. AUTO option disables legacy support if no USB devices are connected. DISABLE option will keep USB devices available only for EFI applications. Options available: Enabled, Disabled, Auto. Default setting is Enabled .
XHCI Hand-off	Enable/Disable the XHCI Hand-off support. Options available: Enabled, Disabled. Default setting is Enabled .
USB Mass Storage Driver Support ^(Note)	Enable/Disable the USB Mass Storage Driver Support. Options available: Disabled, Enabled. Default setting is Enabled .

(Note) This item is present only if you attach USB devices.

Parameter	Description
Port 60/64 Emulation	Enables the I/O port 60h/64h emulation support. This should be enabled for the complete USB Keyboard Legacy support for non-USB aware OS. Options available: Disabled, Enabled. Default setting is Enabled .
USB hardware delays and time-outs	
USB transfer time-out	Selects the time-out value for USB Control/Bulk/Interrupt transfers. Options available: 1 sec, 5 sec, 10 sec, 20 sec. Default setting is 20 sec .
Device reset time-out	Selects the time-out value during a USB mass storage device reset. Options available: 10 sec, 20 sec, 30 sec, 40 sec. Default setting is 20 sec .
Device power-up delay	Maximum time the device will take before it properly reports itself to the Host Controller. "Auto" uses default value: for a Root port it is 100 ms, for a Hub port the delay is taken from Hub descriptor. Options available: Auto, Manual. Default setting is Auto .
Mass Storage Devices	Displays the mass storage devices available on the system.

5-2-9 Network Stack Configuration

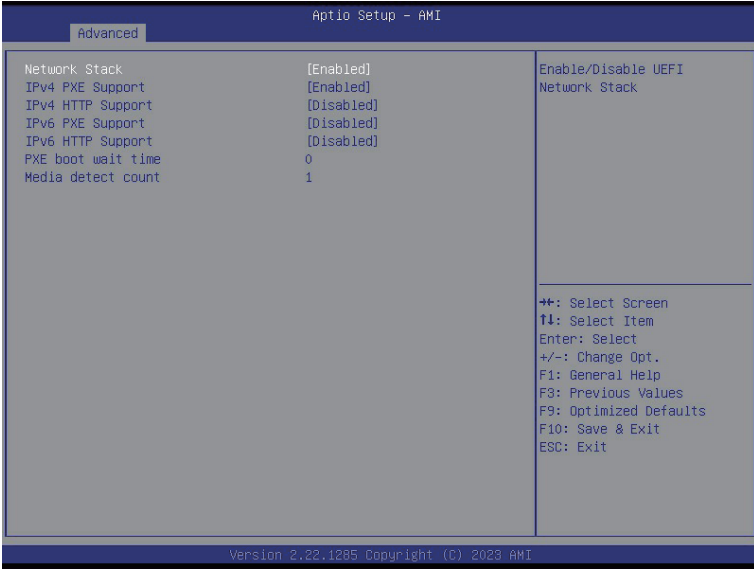

Parameter	Description
Network Stack	Enable/Disable the UEFI network stack. Options available: Disabled, Enabled. Default setting is Enabled .
Ipv4 PXE Support ^(Note)	Enable/Disable the Ipv4 PXE feature. Options available: Disabled, Enabled. Default setting is Enabled .
Ipv4 HTTP Support ^(Note)	Enable/Disable the Ipv4 HTTP feature. Options available: Disabled, Enabled. Default setting is Disabled .
Ipv6 PXE Support ^(Note)	Enable/Disable the Ipv6 PXE feature. Options available: Disabled, Enabled. Default setting is Disabled .
Ipv6 HTTP Support ^(Note)	Enable/Disable the Ipv6 HTTP feature. Options available: Disabled, Enabled. Default setting is Disabled .
PXE boot wait time ^(Note)	Wait time in seconds to press ESC key to abort the PXE boot. Press the <+> / <-> keys to increase or decrease the desired values.
Media detect count ^(Note)	Number of times the presence of media will be checked. Press the <+> / <-> keys to increase or decrease the desired values.

5-2-10 CSM Configuration



Parameter	Description
Compatibility Support Module Configuration	
CSM Support ^(Note)	Enable/Disable CSM support. Options available: Disabled, Enabled. Default setting is Disabled .
CSM16 Module Version	Displays the CSM module version information.
GateA20 Active	Options available: Upon Request, Always. Default setting is Upon Request .
INT19 Trap Response	Options available: Immediate, Postponed. Default setting is Immediate .
HDD Connection Order	Options available: Adjust, Keep. Default setting is Adjust .
Boot option filter	Options available: UEFI and Legacy, Legacy only, UEFI only. Default setting is UEFI and Legacy .
Option ROM execution	
Network/Storage/Video/ Other PCI devices	Options available: UEFI, Legacy. Default setting is UEFI .

(Note) Advanced items prompt when this item is defined.

5-2-11 Post Report Configuration

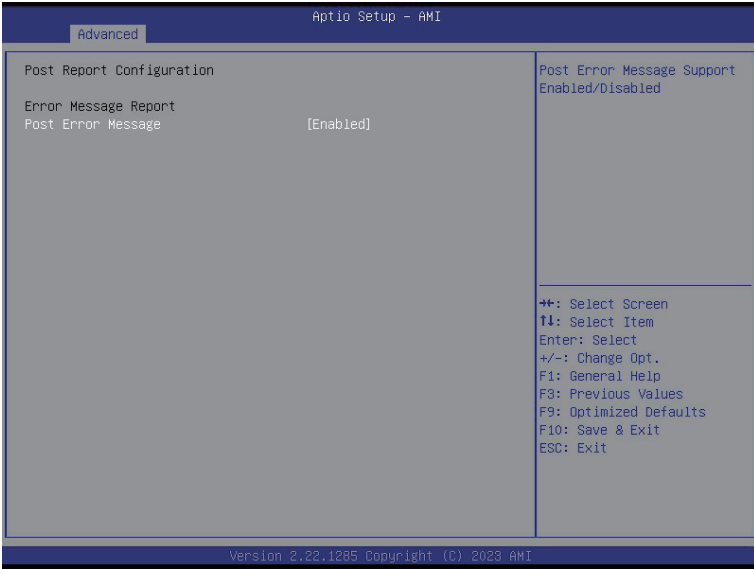

Parameter	Description
Post Report Configuration	
Error Message Report	
Post Error Message	Enable/Disable Post Error Message support. Options available: Disabled, Enabled. Default setting is Enabled .

5-2-12 NVMe Configuration



Parameter	Description
NVMe Configuration	Displays the NVMe devices connected to the system.
NVMe OPROM Select	Options available: BIOS Build-In, NVMe Device. Default setting is BIOS Build-In .

5-2-13 SATA Configuration

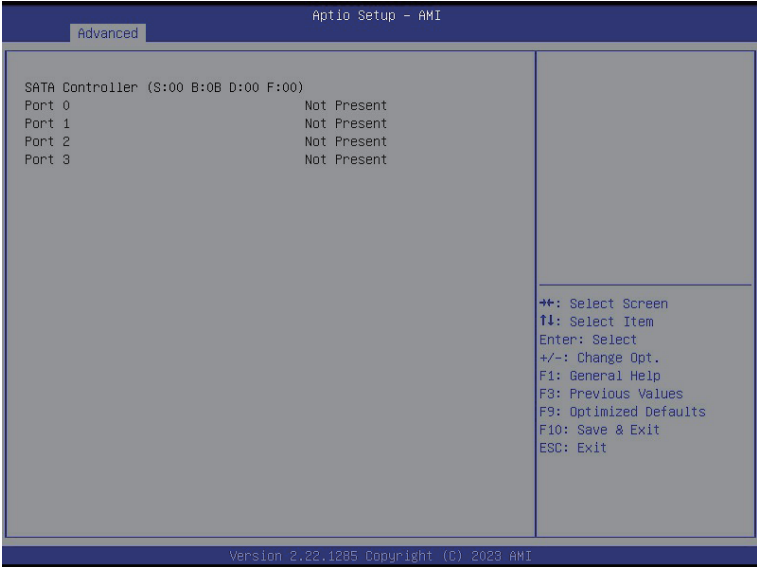

Parameter	Description
SATA Configuration	Displays the installed HDD devices information. System will automatically detect HDD type.

5-2-14 Chipset Configuration

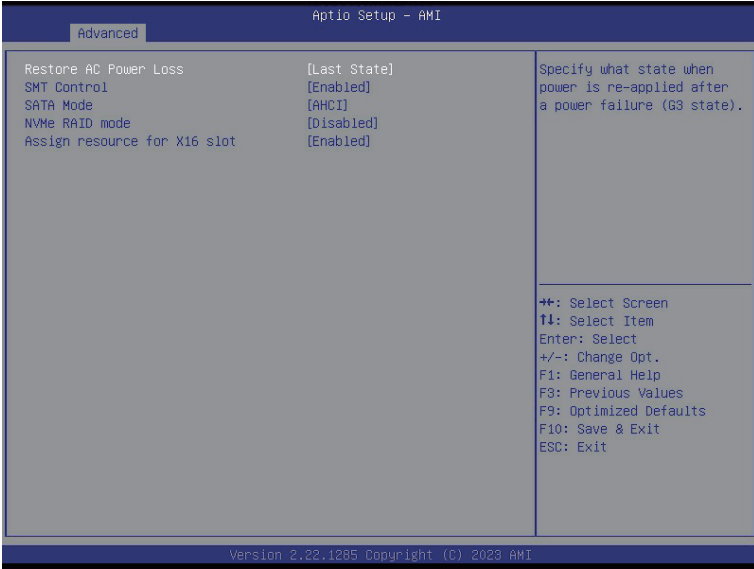

Parameter	Description
Restore AC Power Loss	This option provides user to set the mode of operation if an AC / power loss occurs. Options available: Power Off, Power On, Last State, Unspecified. Default setting is Last State .
SMT Control	SMT Control. Options available: Enabled., Disabled. Default setting is Enabled .
SATA Mode	Select SATA mode. Options available: AHCI, RAID. Default setting is AHCI .
NVMe RAID mode	Enable or disable NVMe RAID mode. Please setting the 'PCIe/GFX Lanes Configuration' item according to the RAID configuration. Options available: Enabled., Disabled. Default setting is Enabled .
Assign resource for X16 slot	Assign resource for X16 slot. Options available: Enabled., Disabled. Default setting is Enabled .

5-2-15 RAM Disk Configuration



Parameter	Description
Disk Memory Type	Specifies the type of memory to use from available memory pool in system to create a disk. Options available: Boot Service Data, Reserved. Default setting is Boot Service Data .
Create Raw	Creates a raw RAM disk. <ul style="list-style-type: none"> ◆ Size (Hex) <ul style="list-style-type: none"> – Input a valid RAM disk size that should be multiple of the RAM disk block size. ◆ Create & Exit ◆ Discard & Exit
Create from file	Creates a RAM disk from a given file.
Created RAM disk list	
Remove selected RAM disk(s)	Selects the RAM disk(s) to remove.

5-2-16 Tls Auth Configuration

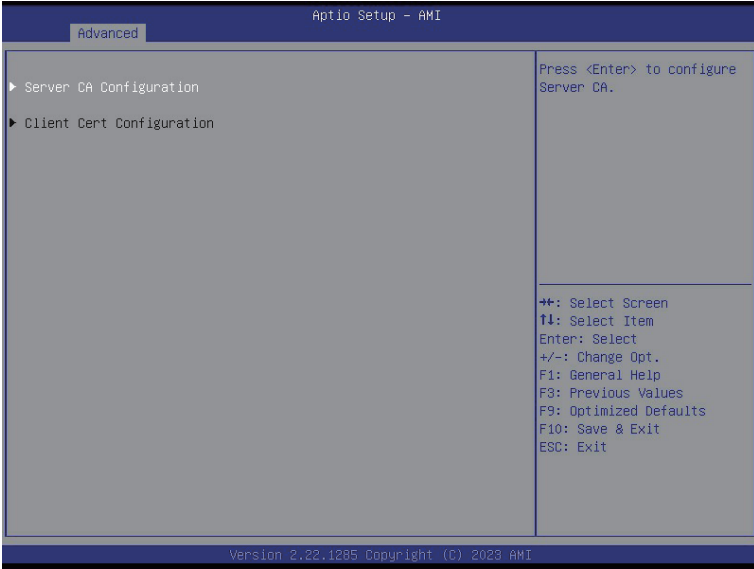

Parameter	Description
Server CA Configuration	<p>Press [Enter] for configuration of advanced items.</p> <ul style="list-style-type: none"> ◆ Enroll Cert <ul style="list-style-type: none"> – Press [Enter] to enroll a certificate <ul style="list-style-type: none"> • Enroll Cert Using File • Cert GUID <p>Input digit character in 1111111-2222-3333-4444-1234567890ab format.</p> <ul style="list-style-type: none"> – Commit Changes and Exit – Discard Changes and Exit ◆ Delete Cert
Client Cert Configuration	Press [Enter] for configuration of advanced items.

5-2-17 iSCSI Configuration

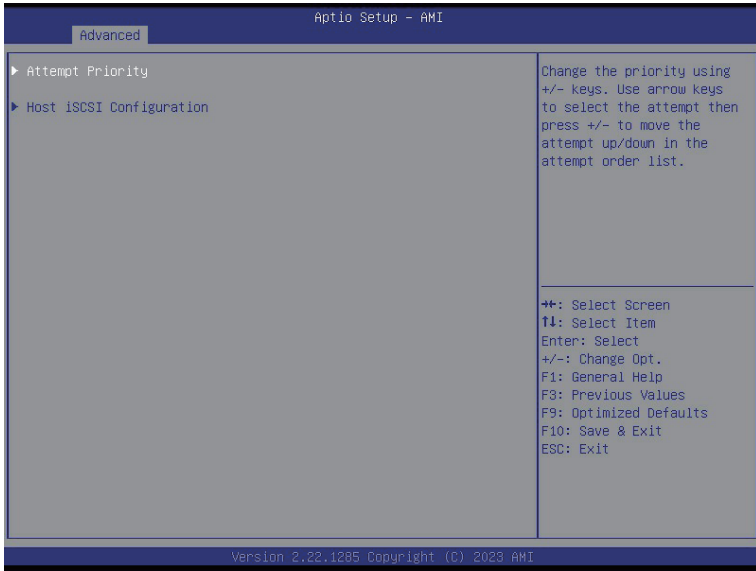

Parameter	Description
Attempt Priority	<ul style="list-style-type: none"> ◆ Attempt Priority <ul style="list-style-type: none"> – Change the attempt priority. – Options available: Host Attempt, Redfish Attempt. Default setting is Host Attempt. ◆ Commit Change and Exit
Host iSCSI Configuration	<ul style="list-style-type: none"> ◆ iSCSI Initiator Name <ul style="list-style-type: none"> – Press [Enter] and name iSCSI Initiator. Only IQN format is accepted. Range: from 4 to 223. ◆ Add an Attempt ◆ Delete Attempts ◆ Change Attempt Order

5-2-18 Broadcom BCM7416 NetXtreme-E 10GBASE-T Network Connection

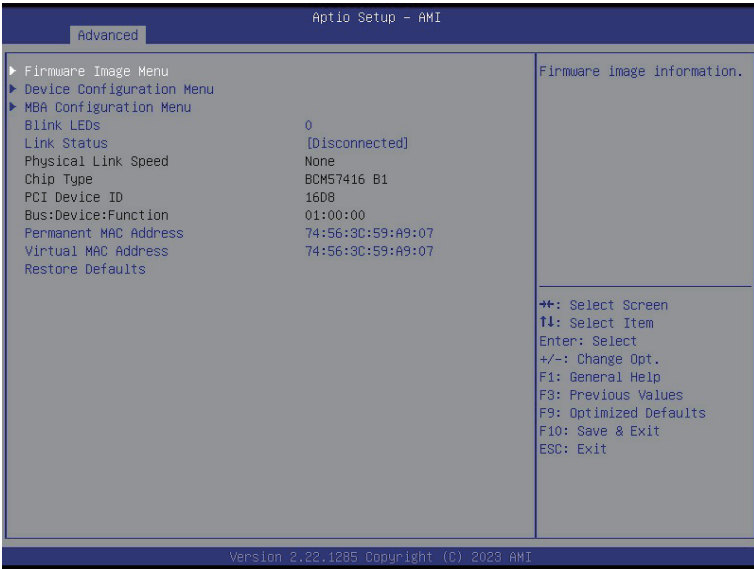

Parameter	Description
Firmware Image Menu	Press [Enter] to view firmware image information.
Device Configuration Menu	<p>Press [Enter] to configure advanced items.</p> <ul style="list-style-type: none"> ◆ Multi-Function Mode <ul style="list-style-type: none"> – Configures the NIC Hardware Mode. – Options available: SF, NPAR 1.0. Default setting is SF. ◆ SR-IOV <ul style="list-style-type: none"> – Enable/Disable Single Root I/O Virtualization. – Options available: Disabled, Enabled. Default setting is Disabled. ◆ Number of MSI-X Vectors per VF <ul style="list-style-type: none"> – Configures the number of MSI-X Vectors per VF (0-128). – Default setting is 16. ◆ Maximum Number of PF MSI-X Vectors <ul style="list-style-type: none"> – Configures the maximum number of PF MSI-X Vectors (0-512 per controller). – Default setting is 74. ◆ Energy Efficient Ethernet <ul style="list-style-type: none"> – Enable/Disable Energy Efficient Ethernet operation. – Options available: Disabled, Enabled. Default setting is Disabled. ◆ Operational Link Speed <ul style="list-style-type: none"> – Configures the link speed setting to be used as the default link speed for the selected port. – Options available: AutoNeg. Default setting is AutoNeg.

Parameter	Description
Device Configuration Menu (continued)	<ul style="list-style-type: none"> ◆ Support RDMA <ul style="list-style-type: none"> – Enable/Disable RDMA support for this port. – Options available: Disabled, Enabled. Default setting is Disabled. ◆ DCB Protocol <ul style="list-style-type: none"> – Enable/Disable DCB protocol. – Options available: Disabled, Enabled (IEEE only), CEE (only), Both (IEEE preferred with fallback to CEE). Default setting is Disabled. ◆ LLDP nearest bridge <ul style="list-style-type: none"> – Enable/Disable LLDP nearest bridge state. – Options available: Disabled, Enabled. Default setting is Enabled. ◆ Default EVB Mode <ul style="list-style-type: none"> – Configures the default Edge Virtual Bridging mode. – Options available: VEB, VEPA, None. Default setting is VEB. ◆ Enable PME Capability <ul style="list-style-type: none"> – Enable/Disable PME Capability support. – Options available: Disabled, Enabled. Default setting is Enabled. ◆ Flow Offload <ul style="list-style-type: none"> – Options available: Enabled, Disabled. Default setting is Disabled. ◆ Live Firmware Upgrade <ul style="list-style-type: none"> – Options available: Enabled, Disabled. Default setting is Disabled. ◆ Adapter Error Recovery <ul style="list-style-type: none"> – Options available: Enabled, Disabled. Default setting is Disabled.
MBA Configuration Menu	<p data-bbox="354 796 689 820">Press [Enter] to configure advanced items.</p> <ul style="list-style-type: none"> ◆ Option ROM <ul style="list-style-type: none"> – Enable/Disable Boot Option ROM. – Options available: Disabled, Enabled. Default setting is Enabled. ◆ Legacy Boot Protocol <ul style="list-style-type: none"> – Selects non-UEFI Boot Protocol: Preboot Execution Environment (PXE)/iSCSI. – Options available: PXE, iSCSI, NONE. Default setting is PXE. ◆ Boot Strap Type <ul style="list-style-type: none"> – Selects the boot strap type. Options available: Auto Detect, BBS, Int 18h, Int 19h. Default setting is Auto Detect. ◆ Hide Setup Prompt <ul style="list-style-type: none"> – Configures whether the Setup Prompt is displayed during ROM initialization. – Options available: Disabled, Enabled. Default setting is Disabled. ◆ Setup Key Stroke <ul style="list-style-type: none"> – Configures key strokes to invoke the configuration menu. – Options available: Ctrl-S, Ctrl-B. Default setting is Ctrl-S. ◆ Banner Message Timeout <ul style="list-style-type: none"> – Selects the timeout value. (0 defaults to 4 seconds, 15 is no delay, 1-14 is timeout value in seconds) – Default setting is 5.

Parameter	Description
MBA Configuration Menu (continued)	<ul style="list-style-type: none"> ◆ Pre-boot Wake On LAN <ul style="list-style-type: none"> – Configures Pre-boot Wake on LAN (WOL). – Options available: Disabled, Enabled. Default setting is Enabled. ◆ VLAN Mode <ul style="list-style-type: none"> – Configures the virtual LAN (VLAN) mode. – Options available: Disabled, Enabled. Default setting is Disabled. ◆ VLAN ID <ul style="list-style-type: none"> – Configures the VLAN ID (1...4094). – This item is available only when VLAN Mode is Enabled. ◆ Boot Retry Count <ul style="list-style-type: none"> – Selects the number of boot retries. – Options available: No Retry, 1 Retry, 2 Retries, 3 Retries, 4 Retries, 5 Retries, 6 Retries, Indefinite Retries. Default setting is No Retry.
Blink LEDs	Identifies the physical network port by blinking the associated LED. Press the numeric keys to adjust desired values.
Link Status	Specifies the link status of the port.
Physical Link Speed	Displays the technical specifications for the Network Interface Controller.
Chip Type	Displays the technical specifications for the Network Interface Controller.
PCI Device ID	Displays the technical specifications for the Network Interface Controller.
Bus:Device:Function	Displays the technical specifications for the Network Interface Controller.
Permanent MAC Address	Displays the MAC address of the Ethernet controller.
Virtual MAC Address	Displays the virtual MAC address of the Ethernet controller.
Restore Defaults	Resets the adapter to factory defaults.

5-2-19 VLAN Configuration

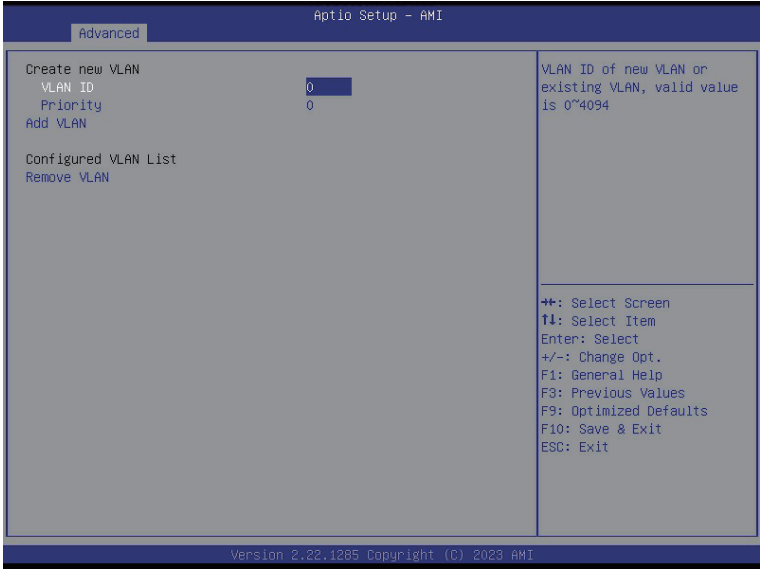

Parameter	Description
Enter Configuration Menu	<p>Press [Enter] to configure advanced items.</p> <ul style="list-style-type: none"> ◆ Create new VLAN ◆ VLAN ID <ul style="list-style-type: none"> – Sets VLAN ID for a new VLAN or an existing VLAN. – Press the <+> / <-> keys to increase or decrease the desired values. – The valid range is from 0 to 4094. ◆ Priority <ul style="list-style-type: none"> – Sets 802.1Q Priority for a new VLAN or an existing VLAN. – Press the <+> / <-> keys to increase or decrease the desired values. – The valid range is from 0 to 7. ◆ Add VLAN <ul style="list-style-type: none"> – Press [Enter] to create a new VLAN or update an existing VLAN. ◆ Configured VLAN List ◆ Remove VLAN <ul style="list-style-type: none"> – Press [Enter] to remove an existing VLAN.

5-2-20 MAC IPv4 Network Configuration



Parameter	Description
Configured	Indicates whether network address is configured successfully or not. Options available: Enabled, Disabled. Default setting is Disabled .
Enable DHCP ^(Note)	Options available: Enabled, Disabled. Default setting is Enabled .
Local IP Address ^(Note)	Press [Enter] to configure local IP address.
Local NetMask ^(Note)	Press [Enter] to configure local NetMask.
Local Gateway ^(Note)	Press [Enter] to configure local Gateway
Local DNS Servers ^(Note)	Press [Enter] to configure local DNS servers
Save Changes and Exit	Press [Enter] to save all configurations.

(Note) This item appears when **Configured** is set to **Enabled**.

5-2-21 MAC IPv6 Network Configuration

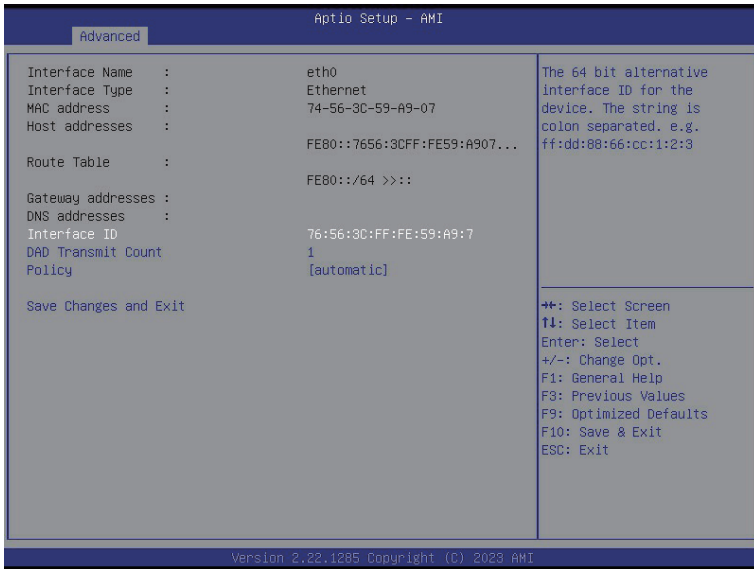

Parameter	Description
Enter Configuration Menu	<p>Press [Enter] to configure advanced items.</p> <ul style="list-style-type: none"> ◆ Displays the MAC Address information. ◆ Interface ID <ul style="list-style-type: none"> – The 64 bit alternative interface ID for the device. The string is colon separated. e.g. ff:dd:88:66:cc:1:2:3. ◆ DAD Transmit Count <ul style="list-style-type: none"> – The number of consecutive Neighbor solicitation messages sent while performing Duplicate Address Detection on a tentative address. A value of zero indicates that Duplicate Address Detection is not performed. ◆ Policy <ul style="list-style-type: none"> – Options available: automatic, manual. Default setting is automatic. ◆ Save Changes and Exit <ul style="list-style-type: none"> – Press [Enter] to save all configurations.

5-2-22 Broadcom NetXtreme Gigabit Ethernet Network Connection

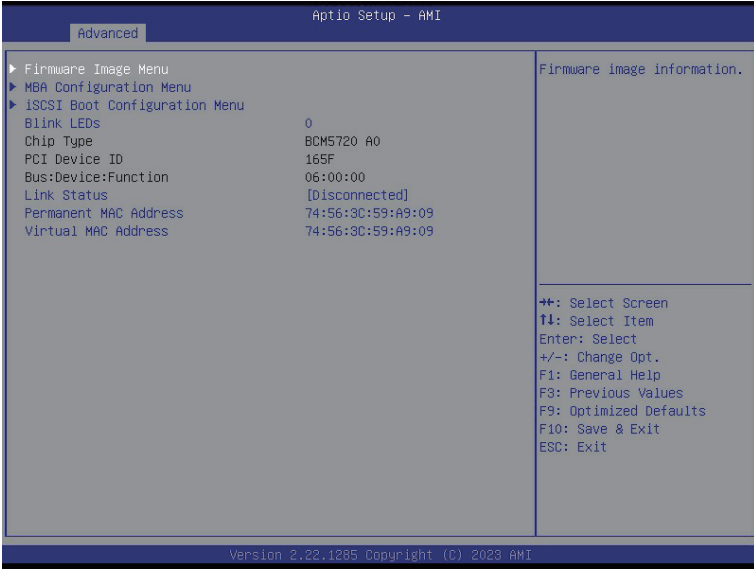

Parameter	Description
Firmware Image Menu	Press [Enter] to view firmware image information.

MBA Device Configuration Menu	<p>Press [Enter] to configure advanced items.</p> <ul style="list-style-type: none"> ◆ Legacy Boot Protocol <ul style="list-style-type: none"> – Select on-UEFI Boot protocol. – PXE, ISCSI, NONE. Default setting is NONE. ◆ BOOT Strap Type <ul style="list-style-type: none"> – Select boot strap type. – Options available: Auto Detect, BBS, Int 18h, Int 19h. Default setting is Auto Detect. ◆ Hide Setup Prompt <ul style="list-style-type: none"> – Configure whether Setup Prompt is displayed during ROM initialization. – Default setting is Disabled. ◆ Setup Key Stroke <ul style="list-style-type: none"> – Configures key strokes to invoke configuration menu. – Default setting is Ctrl-S. ◆ Banner Message Timeout <ul style="list-style-type: none"> – Select timeout value. ◆ Link Speed <ul style="list-style-type: none"> – Configures the link speed. – Options available: AutoNeg, 10Mbps Half, 10Mbps Full, 100Mbps Half, 100Mbps Full. Default setting is AutoNeg. ◆ Pre-boot Wake On LAN <ul style="list-style-type: none"> – Configures Pre-boot Wake On LAN (WOL). – Options available: Enabled, Disabled.. Default setting is Disabled. ◆ VLAN Mode <ul style="list-style-type: none"> – Configures virtual LAN mode. – Options available: Enabled, Disabled.. Default setting is Disabled. ◆ VLAN ID <ul style="list-style-type: none"> – Configures virtual LAN ID. – This item is configurable when VLAN mode is set to Enabled.
iSCSI Boot Configuration Menu	Press [Enter] to configure advanced items.
Blink LEDs	Identifies the physical network port by blinking the associated LED. Press the numeric keys to adjust desired values.
Chip Type	Displays the technical specifications for the Network Interface Controller.
PCI Device ID	Displays the technical specifications for the Network Interface Controller.
Bus:Device:Function	Displays the technical specifications for the Network Interface Controller.
Link Status	Displays the link status.
Permanent MAC Address	Displays the MAC address of the Ethernet controller.
Restore Defaults	Resets the adapter to factory defaults.

5-2-23 VLAN Configuration

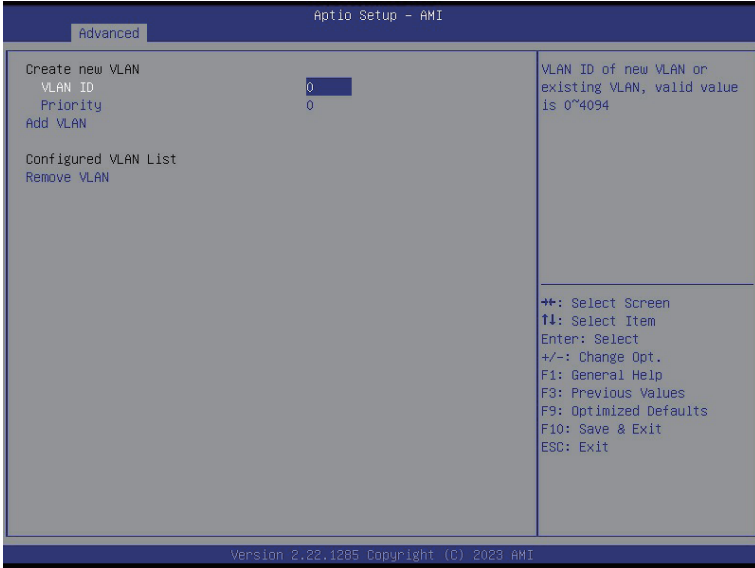

Parameter	Description
Enter Configuration Menu	<p>Press [Enter] to configure advanced items.</p> <ul style="list-style-type: none"> ◆ Create new VLAN ◆ VLAN ID <ul style="list-style-type: none"> – Sets VLAN ID for a new VLAN or an existing VLAN. – Press the <+> / <-> keys to increase or decrease the desired values. – The valid range is from 0 to 4094. ◆ Priority <ul style="list-style-type: none"> – Sets 802.1Q Priority for a new VLAN or an existing VLAN. – Press the <+> / <-> keys to increase or decrease the desired values. – The valid range is from 0 to 7. ◆ Add VLAN <ul style="list-style-type: none"> – Press [Enter] to create a new VLAN or update an existing VLAN. ◆ Configured VLAN List ◆ Remove VLAN <ul style="list-style-type: none"> – Press [Enter] to remove an existing VLAN.

5-2-24 MAC IPv4 Network Configuration

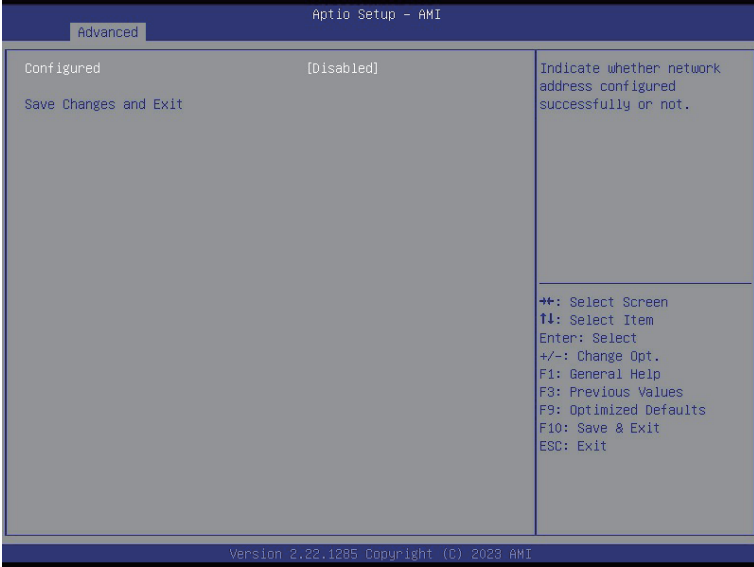

Parameter	Description
Configured	Indicates whether network address is configured successfully or not. Options available: Enabled, Disabled. Default setting is Disabled .
Enable DHCP ^(Note)	Options available: Enabled, Disabled. Default setting is Enabled .
Local IP Address ^(Note)	Press [Enter] to configure local IP address.
Local NetMask ^(Note)	Press [Enter] to configure local NetMask.
Local Gateway ^(Note)	Press [Enter] to configure local Gateway
Local DNS Servers ^(Note)	Press [Enter] to configure local DNS servers
Save Changes and Exit	Press [Enter] to save all configurations.

5-2-25 MAC IPv6 Network Configuration

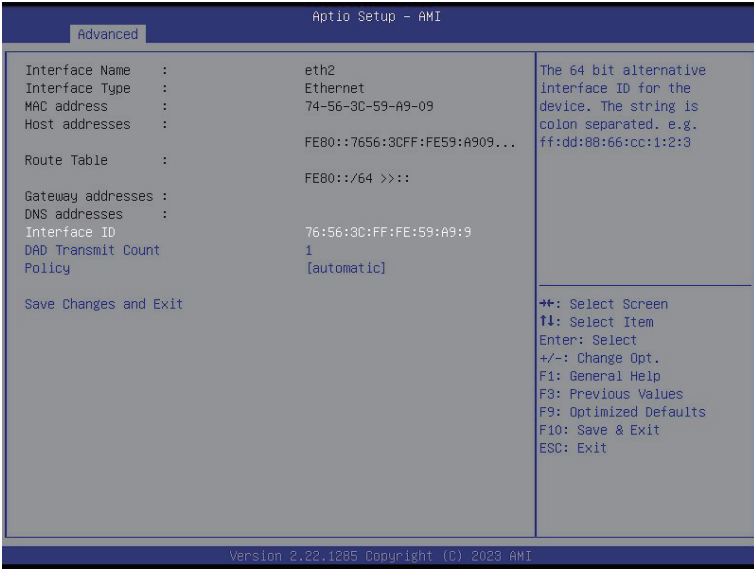

Parameter	Description
Enter Configuration Menu	<p>Press [Enter] to configure advanced items.</p> <ul style="list-style-type: none"> ◆ Displays the MAC Address information. ◆ Interface ID <ul style="list-style-type: none"> – The 64 bit alternative interface ID for the device. The string is colon separated. e.g. ff:dd:88:66:cc:1:2:3. ◆ DAD Transmit Count <ul style="list-style-type: none"> – The number of consecutive Neighbor solicitation messages sent while performing Duplicate Address Detection on a tentative address. A value of zero indicates that Duplicate Address Detection is not performed. ◆ Policy <ul style="list-style-type: none"> – Options available: automatic, manual. Default setting is automatic. ◆ Save Changes and Exit <ul style="list-style-type: none"> – Press [Enter] to save all configurations.

5-2-26 Driver Health



Parameter	Description
Driver Health	Displays driver health status of the devices/controllers if installed.

5-3 Chipset Setup Menu

Chipset Setup menu displays submenu options for configuring the function of the North Bridge. Select a submenu item, then press <Enter> to access the related submenu screen.



Parameter	Description
North Bridge	Press [Enter] for configuration of advanced items.

5-3-1 North Bridge

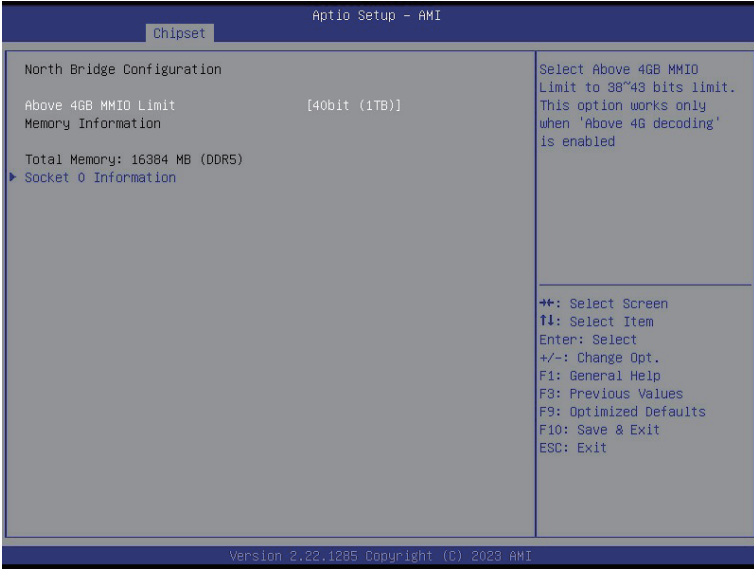

Parameter	Description
North Bridge Configuration	
Above 4GB MMIO Limit	Selects Above 4GB MMIO Limit to 38–43 bits limit. This option works only when "Above 4G decoding" is enabled. Options available: 40bit (1TB), 41bit (2TB), 42bit (4TB), 43bit (8TB). Default setting is 40bit (1TB) .
Memory Information	
Total Memory	Displays the total memory information.
Socket 0 Information	Press [Enter] to view information related to socket 0.

5-4 Server Management Menu

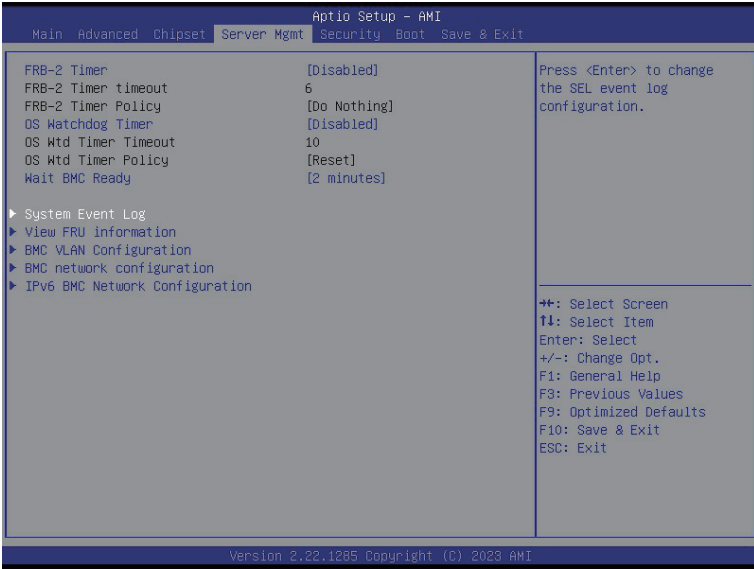

Parameter	Description
FRB-2 Timer	Enable/Disable FRB-2 timer (POST timer). Options available: Enabled, Disabled. Default setting is Disabled .
FRB-2 Timer ^(Note1) timeout	Configures the FRB2 Timer timeout. Options available: 3 minutes, 4 minutes, 5 minutes, 6 minutes. Default setting is 6 minutes .
FRB-2 Timer Policy ^(Note1)	Configures the FRB2 Timer policy. Options available: Do Nothing, Reset, Power Down. Default setting is Do Nothing .
OS Watchdog Timer	Enable/Disable OS Watchdog Timer function. Options available: Enabled, Disabled. Default setting is Disabled .
OS Wtd Timer Timeout ^(Note2)	Configures OS Watchdog Timer. Options available: 5 minutes, 10 minutes, 15 minutes, 20 minutes. Default setting is 10 minutes .
OS Wtd Timer Policy ^(Note2)	Configure OS Watchdog Timer Policy. Options available: Reset, Do Nothing, Power Down. Default setting is Reset .
Serial Mux	Enable/Disable Serial Mux configuration. Options available: Enabled, Disabled. Default setting is Disabled .

(Note1) This item is configurable when **FRB-2 Timer** is set to **Enabled**.

(Note2) This item is configurable when **OS Watchdog Timer** is set to **Enabled**.

Parameter	Description
Wait BMC Ready	Post wait BMC ready and reboot system. Options available: Disabled, 2 minutes, 4 minutes, 6 minutes. Default setting is 2 minutes .
System Event Log	Press [Enter] to configure advanced items.
View FRU Information	Press [Enter] to view the FRU information.
Bmc self test log	Press [Enter] to configure advanced items.
BMC VLAN Configuration	Press [Enter] to configure advanced items.
BMC network configuration	Press [Enter] to configure advanced items.
View System Event Log	Press [Enter] to view the system event log records.
BMC User Settings	Press [Enter] to add, delete and set privilege level for users.
IPv6 BMC Network Configuration	Press [Enter] to configure advanced items.
BMC Warm Reset	Press [Enter] to do warm reset BMC.

5-4-1 System Event Log

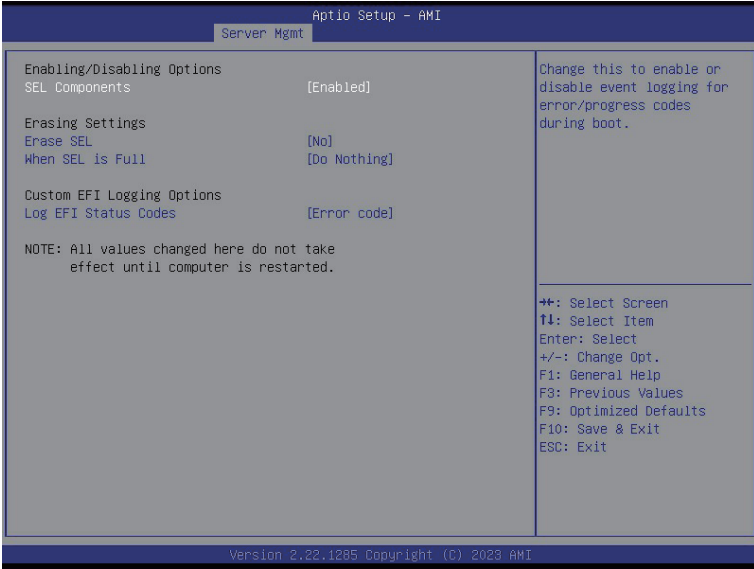

Parameter	Description
Enabling / Disabling Options	
SEL Components	Change this item to enable or disable all features of System Event Logging during boot. Options available: Disabled, Enabled. Default setting is Enabled .
Erasing Settings	
Erase SEL	Choose options for erasing SEL. Options available: No/Yes, On next reset/Yes, On every reset. Default setting is No .
When SEL is Full	Choose options for reactions to a full SEL. Options available: Do Nothing, Erase Immediately, Delete Oldest Record. Default setting is Do Nothing .
Custom EFI Logging Options	
Log EFI Status Codes	Enable/Disable the logging of EFI Status Codes (if not already converted to legacy). Options available: Disabled, Both, Error code, Progress code. Default setting is Error code .

5-4-2 View FRU Information

The FRU page is a simple display page for basic system ID information, as well as System product information. Items on this window are non-configurable.

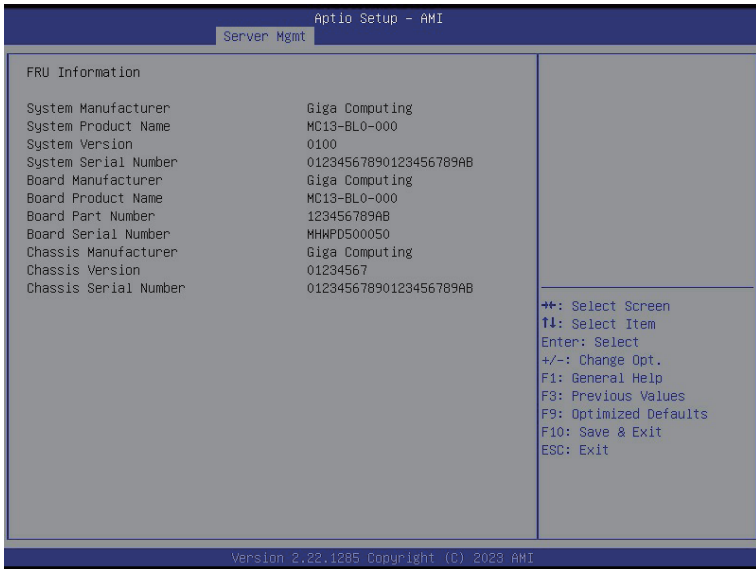

(Note) The model name will vary depends on the product you purchased

5-4-3 BMC VLAN Configuration

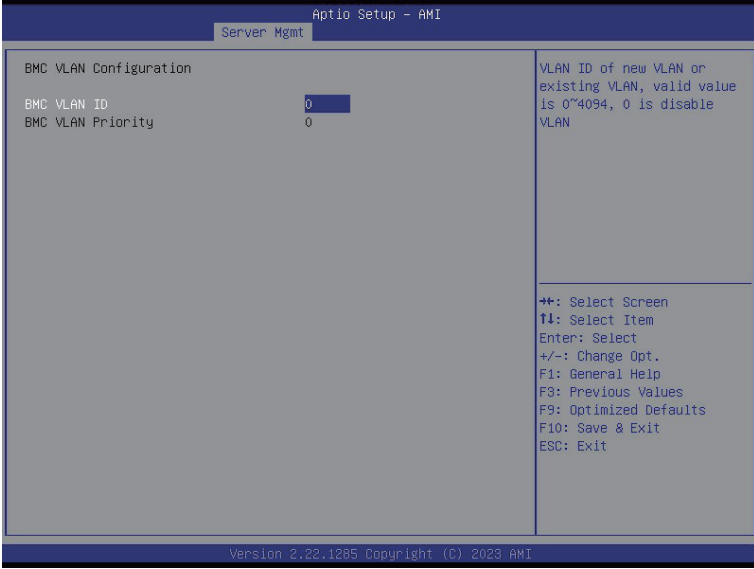

Parameter	Description
BMC VLAN Configuration	
BMC VLAN ID	Sets VLAN ID for a new VLAN or an existing VLAN. Press the <+> / <-> keys to increase or decrease the desired values. The valid range is from 0 to 4094.
BMC VLAN Priority	Sets 802.1Q Priority for a new VLAN or an existing VLAN. Press the <+> / <-> keys to increase or decrease the desired values. The valid range is from 0 to 7.

5-4-4 BMC Network Configuration

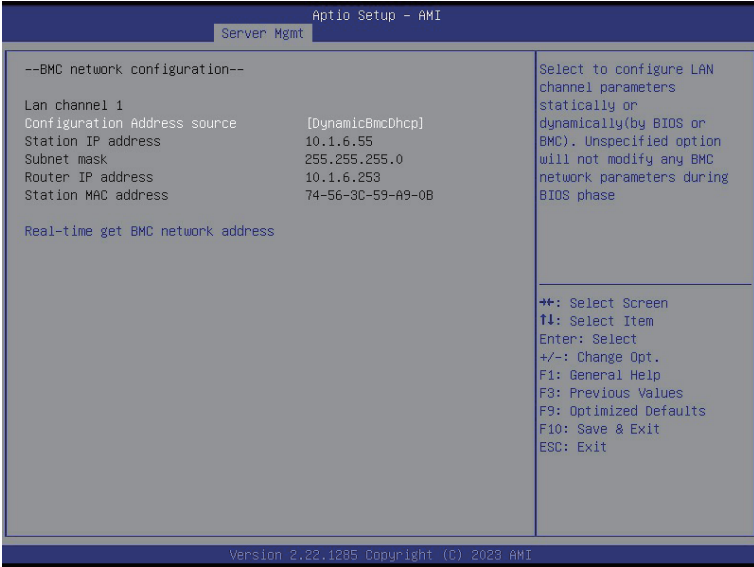

Parameter	Description
BMC network configuration	
Lan Channel 1	
Configuration Address source	Selects to configure LAN channel parameters statically or dynamically (DHCP). Do nothing option will not modify any BMC network parameters during BIOS phase. Options available: Unspecified, Static, DynamicBmcDhcp. Default setting is DynamicBmcDhcp .
Station IP address	Displays IP Address information.
Subnet mask	Displays Subnet Mask information. Please note that the IP address must be in three digitals, for example, 192.168.000.001.
Router IP address	Displays the Router IP Address information.
Station MAC address	Displays the MAC Address information.
Real-time get BMC network address	Press [Enter] will set LAN mode and Address source and then get IP, Subnet, Gateway and MAC address.

5-4-5 IPv6 BMC Network Configuration



Parameter	Description
IPv6 BMC network configuration	
IPv6 BMC Lan Channel 1	
IPv6 BMC Lan Option	Enable/Disable IPv6 BMC LAN channel function. When this item is disabled, the system will not modify any BMC network during BIOS phase. Options available: Unspecified, Disable, Enable. Default setting is Enable .
IPv6 BMC Lan IP Address Source	Selects to configure LAN channel parameters statically or dynamically (by BIOS or BMC). Options available: Unspecified, Static, Dynamic-Obtained by BMC running DHCP. Default setting is Enable Dynamic-Obtained by BMC running DHCP .
IPv6 BMC Lan IP Address/Prefix Length	Check if the IPv6 BMC LAN IP address matches those displayed on the screen.

5-5 Security Menu

The Security menu allows you to safeguard and protect the system from unauthorized use by setting up access passwords.

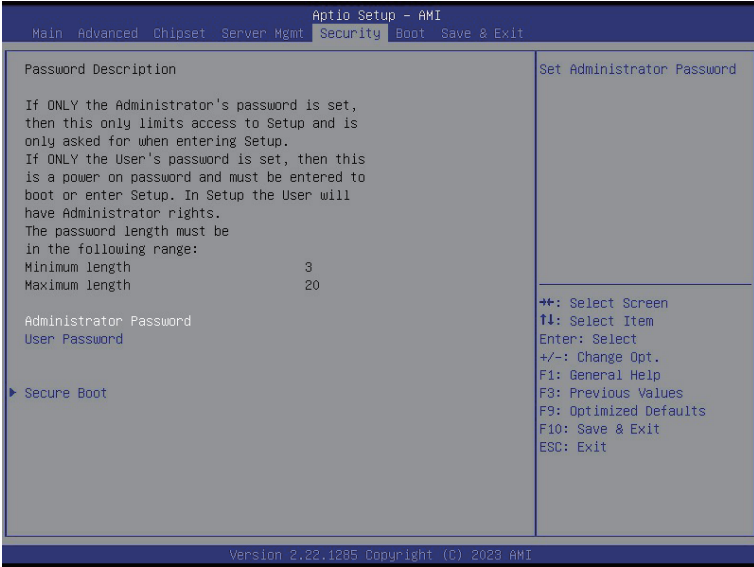

There are two types of passwords that you can set:

- Administrator Password
Entering this password will allow the user to access and change all settings in the Setup Utility.
- User Password
Entering this password will restrict a user's access to the Setup menus. To enable or disable this field, a Administrator Password must first be set. A user can only access and modify the System Time, System Date, and Set User Password fields.

Parameter	Description
Administrator Password	Press [Enter] to configure the administrator password.
User Password	Press [Enter] to configure the user password.
Secure Boot	Press [Enter] to configure advanced items.

5-5-1 Secure Boot

The Secure Boot submenu is applicable when your device is installed the Windows® 8 (or above) operating system.

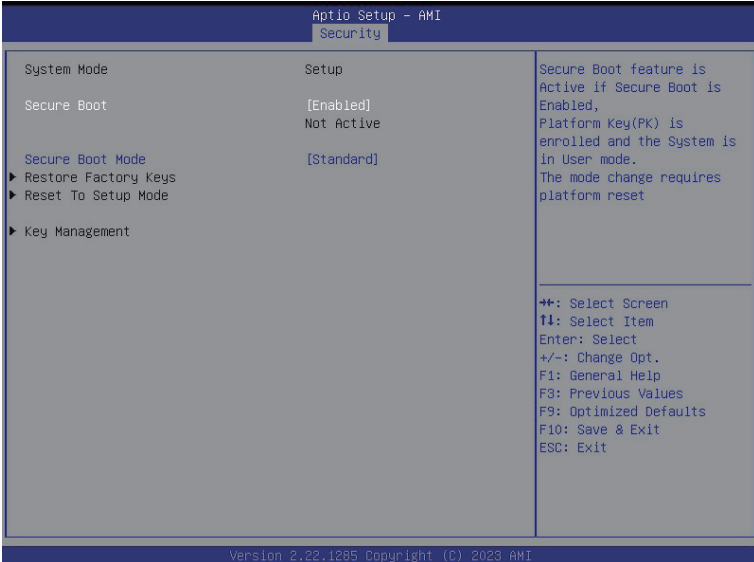

Parameter	Description
System Mode	Displays if the system is in User mode or Setup mode.
Secure Boot	Enable/ Disable the Secure Boot function. Options available: Enabled, Disabled. Default setting is Disabled .
Secure Boot Mode ^(Note)	Secure Boot requires all the applications that are running during the booting process to be pre-signed with valid digital certificates. This way, the system knows all files being loaded before Windows loads to the login screen have not been tampered with. When set to Standard, it will automatically load the Secure Boot keys form the BIOS databases. When set to Custom, you can customize the Secure Boot settings and manually load its keys from the BIOS database. Options available: Standard, Custom. Default setting is Standard .
Restore Factory Keys	Forces the system to user mode and installs factory default Secure Boot key database.
Reset to Setup Mode	Press [Enter] to reset the system to Setup mode.

(Note) Advanced items prompt when this item is set to **Custom**.

Parameter	Description
Key Management	<p data-bbox="334 158 666 181">Press [Enter] to configure advanced items.</p> <p data-bbox="334 186 937 236">Please note that this item is configurable when Secure Boot Mode is set to Custom.</p> <ul style="list-style-type: none"> <li data-bbox="334 241 944 349">◆ Factory Key Provision <ul style="list-style-type: none"> <li data-bbox="370 271 944 321">– Allows to provision factory default Secure Boot keys when system is in Setup Mode. <li data-bbox="370 326 905 349">– Options available: Enabled, Disabled. Default setting is Disabled. <li data-bbox="334 354 926 432">◆ Restore Factory Keys <ul style="list-style-type: none"> <li data-bbox="370 384 926 407">– Installs all factory default keys. It will force the system in User Mode. <li data-bbox="370 412 604 432">– Options available: Yes, No. <li data-bbox="334 437 902 517">◆ Enroll Efi Image <ul style="list-style-type: none"> <li data-bbox="370 467 902 517">– Press [Enter] to enroll SHA256 hash of the binary into Authorized Signature Database (db). <li data-bbox="334 522 898 572">◆ Secure Boot variable <ul style="list-style-type: none"> <li data-bbox="370 551 898 572">– Displays the current status of the variables used for secure boot. <li data-bbox="334 577 802 685">◆ Platform Key (PK) <ul style="list-style-type: none"> <li data-bbox="370 606 802 630">– Displays the current status of the Platform Key (PK). <li data-bbox="370 635 678 658">– Press [Enter] to configure a new PK. <li data-bbox="370 663 602 685">– Options available: Update. <li data-bbox="334 689 942 824">◆ Key Exchange Keys (KEK) <ul style="list-style-type: none"> <li data-bbox="370 719 942 743">– Displays the current status of the Key Exchange Key Database (KEK). <li data-bbox="370 747 905 798">– Press [Enter] to configure a new KEK or load additional KEK from storage devices. <li data-bbox="370 802 671 824">– Options available: Update, Append. <li data-bbox="334 829 944 964">◆ Authorized Signatures (DB) <ul style="list-style-type: none"> <li data-bbox="370 859 905 882">– Displays the current status of the Authorized Signature Database. <li data-bbox="370 887 944 937">– Press [Enter] to configure a new DB or load additional DB from storage devices. <li data-bbox="370 942 671 964">– Options available: Update, Append. <li data-bbox="334 969 902 1103">◆ Forbidden Signatures (DBX) <ul style="list-style-type: none"> <li data-bbox="370 998 902 1022">– Displays the current status of the Forbidden Signature Database. <li data-bbox="370 1027 891 1077">– Press [Enter] to configure a new dbx or load additional dbx from storage devices. <li data-bbox="370 1081 671 1103">– Options available: Update, Append. <li data-bbox="334 1108 929 1243">◆ Authorized TimeStamps (DBT) <ul style="list-style-type: none"> <li data-bbox="370 1138 929 1161">– Displays the current status of the Authorized TimeStamps Database. <li data-bbox="370 1166 905 1216">– Press [Enter] to configure a new DBT or load additional DBT from storage devices. <li data-bbox="370 1221 671 1243">– Options available: Update, Append. <li data-bbox="334 1248 919 1382">◆ OsRecovery Signatures <ul style="list-style-type: none"> <li data-bbox="370 1277 919 1301">– Displays the current status of the OsRecovery Signature Database. <li data-bbox="370 1306 887 1356">– Press [Enter] to configure a new OsRecovery Signature or load additional OsRecovery Signature from storage devices. <li data-bbox="370 1361 671 1382">– Options available: Update, Append.

5-6 Boot Menu

The Boot menu allows you to set the drive priority during system boot-up. BIOS setup will display an error message if the legacy drive(s) specified is not bootable.

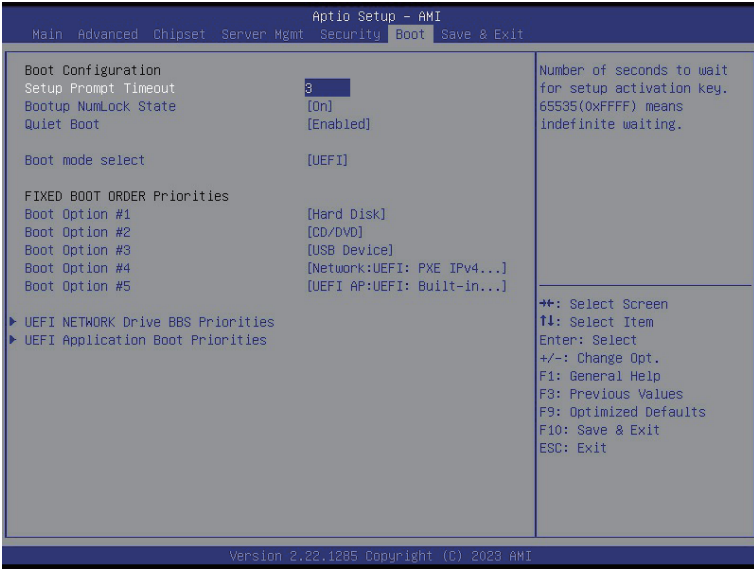

Parameter	Description
Boot Configuration	
Setup Prompt Timeout	Number of seconds to wait for setup activation key. 65535 (0xFFFF) means indefinite waiting. Press the numeric keys to input the desired values.
Bootup NumLock State	Enable/Disable the Bootup NumLock function. Options available: On, Off. Default setting is On .
Quiet Boot	Enable/Disable showing the logo during POST. Options available: Enabled, Disabled. Default setting is Enabled .
Boot mode select	Selects the boot mode. Options available: LEGACY, UEFI. Default setting is UEFI .
FIXED BOOT ORDER Priorities	
Boot Option #1 / #2 / #3 / #4 / #5	Press [Enter] to configure the boot order priority. By default, the server searches for boot devices in the following sequence: <ol style="list-style-type: none"> 1. Hard drive. 2. CD-COM/DVD drive. 3. USB device. 4. Network. 5. UEFI.

5-7 Save & Exit Menu

The Save & Exit menu displays the various options to quit from the BIOS setup. Highlight any of the exit options then press <Enter>.

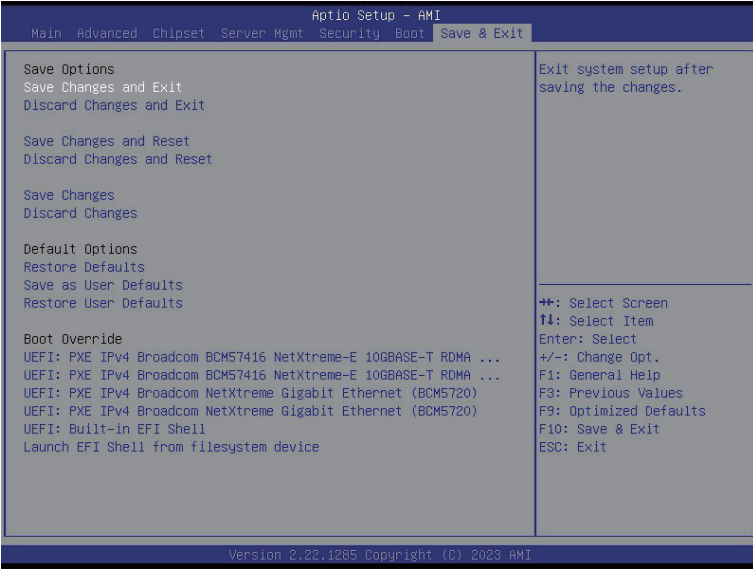

Parameter	Description
Save Options	
Save Changes and Exit	Saves changes made and closes the BIOS setup. Options available: Yes, No.
Discard Changes and Exit	Discards changes made and exits the BIOS setup. Options available: Yes, No.
Save Changes and Reset	Restarts the system after saving the changes made. Options available: Yes, No.
Discard Changes and Reset	Restarts the system without saving any changes. Options available: Yes, No.
Save Changes	Saves changes done so far to any of the setup options. Options available: Yes, No.
Discard Changes	Discards changes made and closes the BIOS setup. Options available: Yes, No.
Default Options	

Parameter	Description
Restore Defaults	Loads the default settings for all BIOS setup parameters. Setup Defaults are quite demanding in terms of resources consumption. If you are using low-speed memory chips or other kinds of low-performance components and you choose to load these settings, the system might not function properly. Options available: Yes, No.
Save as User Defaults	Saves the changes made as the user default settings. Options available: Yes, No.
Restore User Defaults	Loads the user default settings for all BIOS setup parameters. Options available: Yes, No.
Boot Override	Press [Enter] to configure the device as the boot-up drive.
Launch EFI Shell from filesystem device	Attempts to Launch EFI Shell application (Shell.efi) from one of the available file system devices.

5-8 BIOS Recovery

The system has an embedded recovery technique. In the event that the BIOS becomes corrupt the boot block can be used to restore the BIOS to a working state. To restore your BIOS, please follow the instructions listed below:

Recovery Instruction:

1. Copy the XXX.rom to USB diskette.
2. Setting BIOS Recovery jump to enabled status.
3. Boot into BIOS recovery.
4. Run Proceed with flash update.
5. BIOS updated.

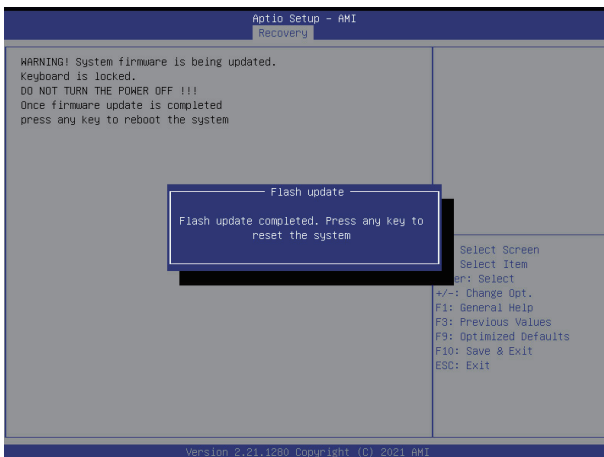
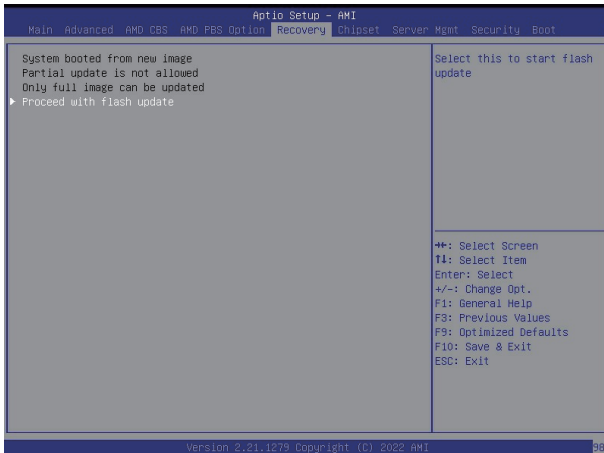

5-9 BIOS POST Beep code (AMI standard)

5-9-1 PEI Beep Codes

# of Beeps	Description
1	Memory not Installed.
1	Memory was installed twice (InstallPeiMemory routine in PEI Core called twice)
2	Recovery started
3	DXE IPL was not found
3	DXE Core Firmware Volume was not found
4	Recovery failed
4	S3 Resume failed
7	Reset PPI is not available

5-9-2 DXE Beep Codes

# of Beeps	Description
1	Invalid password
4	Some of the Architectural Protocols are not available
5	No Console Output Devices are found
5	No Console Input Devices are found
6	Flash update is failed
7	Reset protocol is not available
8	Platform PCI resource requirements cannot be met