

GIGABYTE™

H374-A81-LAW1

High Density Server - Intel® Xeon® 6 Processors
3U 4-Node DP 8-Bay Gen5 NVMe/SATA/SAS-4 DLC

User Manual

Rev. 1.0

Copyright

© 2025 Giga Computing Technology CO., LTD. All rights reserved.

The trademarks mentioned in this manual are legally registered to their respective owners.

Disclaimer

Information in this manual is protected by copyright laws and is the property of Giga Computing. Changes to the specifications and features in this manual may be made by Giga Computing without prior notice. No part of this manual may be reproduced, copied, translated, transmitted, or published in any form or by any means without Giga Computing's prior written permission.

Documentation Classifications

In order to assist in the use of this product, Giga Computing provides the following types of documentation:

- User Manual: detailed information & steps about the installation, configuration and use of this product (e.g. motherboard, server barebones), covering hardware and BIOS.
- User Guide: detailed information about the installation & use of an add-on hardware or software component (e.g. BMC firmware, rail-kit) compatible with this product.
- Quick Installation Guide: a short guide with visual diagrams that you can reference easily for installation purposes of this product (e.g. motherboard, server barebones).

Please see the support section of the online product page to check the current availability of these documents.

For More Information

For related product specifications, the latest firmware and software, and other information please visit our website at <http://www.gigabyte.com/Enterprise>

For GIGABYTE distributors and resellers, additional sales & marketing materials are available from our reseller portal: <http://reseller.b2b.gigabyte.com>

For further technical assistance, please contact your GIGABYTE representative or visit <https://support.gigabyte.com/> to create a new support ticket

For any general sales or marketing enquiries, you may also message GIGABYTE server directly by email: server.grp@gigabyte.com

Conventions

The following conventions are used in this user's guide:

	NOTE! Pieces of additional information related to the current topic.
	CAUTION! Precautionary measures to avoid possible hardware or software problems.
	WARNING! Alerts to any damage that might result from doing or not doing specific actions.

Server Warnings and Cautions

Before installing a server, be sure that you understand the following warnings and cautions.



WARNING!

To reduce the risk of electric shock or damage to the equipment:

- Do not disable the power cord grounding plug. The grounding plug is an important safety feature.
- Plug the power cord into a grounded (earthed) electrical outlet that is easily accessible at all times.
- Unplug the power cord from the power supply to disconnect power to the equipment.

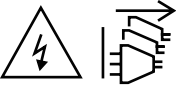

- Shock Hazard! Disconnect all power supply cords before servicing.
- Do not route the power cord where it can be walked on or pinched by items placed against it. Pay particular attention to the plug, electrical outlet, and the point where the cord extends from the server.
- Do not route the power cord where it can be walked on or pinched by items placed against it. Pay particular attention to the plug, electrical outlet, and the point where the cord extends from the server.



WARNING!

To reduce the risk of personal injury from hot surfaces, allow the drives and the internal system components to cool before touching them.



This server is equipped with high speed fans. Keep away from hazardous moving fan blades during servicing.



This equipment is intended to be used in Restrict Access Location. The access can only be gained by Skilled person. Only authorized by well trained professional person can access the restrict access location.

•



This equipment is not intended for use by children.

**CAUTION!**

- Do not operate the server for long periods with the access panel open or removed. Operating the server in this manner results in improper airflow and improper cooling that can lead to thermal damage.
- Danger of explosion if battery is incorrectly replaced.
- Replace only with the same or equivalent type recommended by the manufacturer.
- Dispose of used batteries according to the manufacturer's instructions.

**CAUTION!**

Risk of explosion if battery is replaced incorrectly or with an incorrect type. Replace the battery only with the same or equivalent type recommended by the manufacturer. Dispose of used batteries according to the manufacturer's instructions.

Warning Stability hazard

The slide-rail may tip over causing serious personal injury

- Before extending the rack to its installation position, read the installation instructions.
- Do not put any load on the slide-rail mounted equipment in the installation position.
- Do not leave the slide-rail mounted equipment in the installation position.



Electrostatic Discharge (ESD)

CAUTION!

ESD CAN DAMAGE DRIVES, BOARDS, AND OTHER PARTS. WE RECOMMEND THAT YOU PERFORM ALL PROCEDURES AT AN ESD WORKSTATION. IF ONE IS NOT AVAILABLE, PROVIDE SOME ESD PROTECTION BY WEARING AN ANTI-STATIC WRIST STRAP ATTACHED TO CHASSIS GROUND -- ANY UNPAINTED METAL SURFACE -- ON YOUR SERVER WHEN HANDLING PARTS.

Always handle boards carefully, they can be extremely sensitive to ESD. Hold boards only by their edges without touching any components or connectors. After removing a board from its protective ESD bag or from the system, place the board component side up on a grounded, static free surface. Use a conductive foam pad if available but not the ESD bag. Do not slide the board over any surface.

System power on/off: To service components within the server, please ensure the power has been disconnected.

e.g. Remove the node from the server chassis (to disconnect power) or disconnect the power from the server chassis.

Make sure the system is removed from the rack before opening the chassis, adding, or removing any non hot-plug components.

Hazardous conditions, devices and cables: Hazardous electrical conditions may be present on power, telephone, and communication cables. Turn off the system chassis and disconnect the cables attached to the system before servicing the chassis. Otherwise, personal injury or equipment damage can result.

Electrostatic discharge (ESD) and ESD protection: ESD can damage drives, boards, and other parts. We recommend that you perform all procedures in this chapter only at an ESD workstation. If one is not available, provide some ESD protection by wearing an antistatic wrist strap attached to chassis ground (any unpainted metal surface on the server) when handling parts.

ESD and handling boards: Always handle boards carefully. They can be extremely sensitive to electrostatic discharge (ESD). Hold boards only by their edges. After removing a board from its protective wrapper or from the system, place the board component side up on a grounded, static free surface. Use a conductive foam pad if available but not the board wrapper. Do not slide board over any surface.

Installing or removing jumpers: A jumper is a small plastic encased conductor that slips over two jumper pins. Some jumpers have a small tab on top that can be gripped with fingertips or with a pair of fine needle nosed pliers. If the jumpers do not have such a tab, take care when using needle nosed pliers to remove or install a jumper; grip the narrow sides of the jumper with the pliers, never the wide sides. Gripping the wide sides can damage the contacts inside the jumper, causing intermittent problems with the function controlled by that jumper. Take care to grip with, but not squeeze, the pliers or other tool used to remove a jumper, or the pins on the board may bend or break.

Table of Contents

Chapter 1 Hardware Installation	11
1-1 Installation Precautions	11
1-2 Product Specifications	12
1-3 System Block Diagram	15
1-4 CMC Hub Integrated Architecture	16
1-5 Multiplexing Management Topology	17
Chapter 2 System Appearance	19
2-1 Front View	19
2-2 Rear View	20
2-3 Front Panel LED and Buttons	21
2-4 RoT LEDs	22
2-5 Rear System LAN LEDs	24
2-6 Power Supply Unit LED	25
2-7 Hard Disk Drive LEDs	26
Chapter 3 System Hardware Installation	27
3-1 Installing the Hard Disk Drive	28
3-2 Removing the Node	29
3-3 How to Get the BMC Password	30
3-4 Removing Chassis Cover	31
3-5 Liquid Cooling Assembly Information	32
3-5-1 Liquid Cooling Specifications	33
3-6 Removing the Coolant Pipe Module	34
3-7 Installing the CPU and the Coolant Pipe Module	35
3-8 Installing Memory	37
3-8-1 Twelves Channel Memory Configuration	37
3-8-2 Installing the Memory	38
3-8-3 DIMM Population Table	39
3-8-4 Processor and Memory Module Matrix Table	41
3-9 Installing the PCI Expansion Card	42
3-10 Removing and Installing the Rear IO Card	44
3-11 Replacing the Fan Assembly	45
3-12 Replacing the Power Supply	46
3-13 Cable Routing	47

Chapter 4 Motherboard Components	53
4-1 Motherboard Components	53
4-2 Jumper Setting	54
4-3 Backplane Board Storage Connector.....	55
4-3-1 CBPH081.....	55
Chapter 5 BIOS Setup	56
5-1 The Main Menu	58
5-2 Advanced Menu	61
5-2-1 Trusted Computing.....	62
5-2-2 Serial Port Console Redirection	63
5-2-3 SIO Configuration	66
5-2-4 PCI Subsystem Settings.....	67
5-2-5 USB Configuration.....	69
5-2-6 Network Stack Configuration	70
5-2-7 Post Report Configuration	71
5-2-8 KMIP Server Configuration	72
5-2-9 NVMe Configuration	73
5-2-10 Chipset Configuration	74
5-2-11 Tls Auth Configuration	75
5-2-12 iSCSI Configuration	76
5-2-13 Intel(R) i350 Gigabit Network Connection	77
5-2-14 VLAN Configuration.....	79
5-2-15 MAC IPv6 Network Configuration	80
5-2-16 MAC IPv4 Network Configuration.....	81
5-2-17 Driver Health.....	82
5-3 Chipset Menu.....	83
5-3-1 Processor Configuration	84
5-3-2 Common RefCode Configuration	87
5-3-3 UPI Configuration	88
5-3-4 Memory Configuration	90
5-3-5 IIO Configuration	93
5-3-6 Advanced Power Management Configuration	94
5-3-7 Miscellaneous Configuration	97
5-3-8 Runtime Error Logging Settings	98
5-3-9 Power Policy.....	100
5-4 Server Management Menu.....	102
5-4-1 System Event Log	104
5-4-2 View FRU Information	105
5-4-3 BMC VLAN Configuration.....	106
5-4-4 BMC Network Configuration.....	107

5-4-5	IPv6 BMC Network Configuration	108
5-5	Security Menu	109
5-5-1	Secure Boot	110
5-6	Boot Menu	113
5-7	Save & Exit Menu.....	115
5-8	BIOS Recovery	117

Chapter 1 Hardware Installation

1-1 Installation Precautions

The motherboard/system contain numerous delicate electronic circuits and components which can become damaged as a result of electrostatic discharge (ESD). Prior to installation, carefully read the user manual and follow these procedures:









- Prior to installation, do not remove or break motherboard S/N (Serial Number) sticker or warranty sticker provided by your dealer. These stickers are required for warranty validation.
- Always remove the AC power by unplugging the power cord from the power outlet before installing or removing the motherboard or other hardware components.
- When connecting hardware components to the internal connectors on the motherboard, make sure they are connected tightly and securely.
- When handling the motherboard, avoid touching any metal leads or connectors.
- It is best to wear an electrostatic discharge (ESD) wrist strap when handling electronic components such as a motherboard, CPU or memory. If you do not have an ESD wrist strap, keep your hands dry and first touch a metal object to eliminate static electricity.
- Prior to installing the motherboard, please have it on top of an antistatic pad or within an electrostatic shielding container.
- Before unplugging the power supply cable from the motherboard, make sure the power supply has been turned off.
- Before turning on the power, make sure the power supply voltage has been set according to the local voltage standard.
- Before using the product, please verify that all cables and power connectors of your hardware components are connected.
- To prevent damage to the motherboard, do not allow screws to come in contact with the motherboard circuit or its components.
- Make sure there are no leftover screws or metal components placed on the motherboard or within the computer casing.
- Do not place the computer system on an uneven surface.
- Do not place the computer system in a high-temperature environment.
- Turning on the computer power during the installation process can lead to damage to system components as well as physical harm to the user.
- If you are uncertain about any installation steps or have a problem related to the use of the product, please consult a certified computer technician.





1-2 Product Specifications







NOTE:

We reserve the right to make any changes to the product specifications and product-related information without prior notice.

 	System Dimension	<ul style="list-style-type: none"> ◆ 3U 4-Node - Rear access ◆ 447 (W) x 130.8 (H) x 895 (D) mm
	CPU	<p>Intel® Xeon® 6 Processors</p> <ul style="list-style-type: none"> ◆ Intel® Xeon® 6900-Series Processors ◆ Dual processor per node, TDP up to 500W <p>[Note] If only 1 CPU is installed, some PCIe or memory functions might be unavailable.</p>
	Socket	<ul style="list-style-type: none"> ◆ 8 x LGA 7529 ◆ Socket BR
	Chipset	<ul style="list-style-type: none"> ◆ System on Chip
	Memory	<ul style="list-style-type: none"> ◆ 96 x DIMM slots ◆ DDR5 memory supported ◆ 12-Channel memory per processor ◆ MRDIMM supported [1] ◆ RDIMM: Up to 6400 MT/s ◆ MRDIMM: Up to 8800 MT/s ◆ <p>[1] MRDIMMs are only supported with Intel® Xeon® 6 Processors with P-cores.</p>
	LAN	<p>Rear (I/O board - CLNP319 x 4):</p> <ul style="list-style-type: none"> ◆ 8 x 1Gb/s LAN (4 x Intel® I350-AM2) ◆ Support NCSI function ◆ 4 x 10/100/1000 Mbps Management LAN [1] <p>[1] Spanning Tree Protocol (STP) must be enabled on LAN switches when using a ring topology.</p>
	Video	<ul style="list-style-type: none"> ◆ Integrated in Aspeed® AST2600 x 4 ◆ 4 x Mini-DP
	Storage	<p>Front hot-swap:</p> <ul style="list-style-type: none"> ◆ 8 x 2.5" Gen5 NVMe/SATA/SAS-4 [1] ◆ (NVMe from CPU_1) <p>[1] Storage card is required to support SATA and SAS drives.</p>

	SAS	<ul style="list-style-type: none"> ◆ Require SAS add-in cards
	RAID	<ul style="list-style-type: none"> ◆ Require RAID add-in cards ◆ Onboard VROC key header
	Expansion Slots	<p>PCIe Cable x 8:</p> <ul style="list-style-type: none"> ◆ 8 x LP x16 (Gen5 x16), from CPU_1 <p>Riser Card CRCH010 x 8:</p> <ul style="list-style-type: none"> ◆ 4 x LP x16 (Gen5 x16), from CPU_0 ◆ 4 x LP x16 (Gen5 x16), from CPU_0 [1] <ul style="list-style-type: none"> ◆ [1] Enabling the slots requires specific cold plate loops and tubes relocation. Please contact our sales representatives if the feature is needed.
	Front I/O	<ul style="list-style-type: none"> ◆ 4 x Power buttons with LED ◆ 4 x ID buttons with LED ◆ 4 x Reset buttons ◆ 4 x System status LEDs ◆ 1 x CMC status LED ◆ 1 x CMC reset button
	Rear I/O	<p>I/O board - CLNP319 x 4:</p> <ul style="list-style-type: none"> ◆ 8 x USB 3.2 Gen1 ports (Type-A) ◆ 4 x Mini-DP ◆ 8 x RJ45 ports ◆ 4 x MLAN ports ◆ 4 x ID buttons with LED ◆ 4 x System status LEDs

	Backplane Board <ul style="list-style-type: none"> ◆ Speed and bandwidth: ◆ PCIe Gen5 x4 or SATA 6Gb/s or SAS-4 24Gb/s
	Security Modules <ul style="list-style-type: none"> ◆ 4 x TPM headers with SPI interface ◆ Optional TPM2.0 kit: CTM012 ◆ 4 x PRoT connectors (only enabled on RoT SKU)
	Power Supply <ul style="list-style-type: none"> ◆ Triple 3000W 80 PLUS Titanium redundant power supply ^[1] <p>AC Input:</p> <ul style="list-style-type: none"> ◆ 100-240V <p>[1] The system power supply requires C19 power cord. [Note] Please refer to GIGABYTE Website for detail power supply specification.</p>
	System Management <ul style="list-style-type: none"> ◆ ASPEED® AST2600 Baseboard Management Controller ◆ ASPEED® AST2620 Chassis Management Controller ◆ GIGABYTE Management Console web interface <ul style="list-style-type: none"> ◆ Dashboard ◆ HTML5 KVM ◆ Sensor Monitor (Voltage, RPM, Temperature, CPU Status ...etc.) ◆ Sensor Reading History Data ◆ FRU Information ◆ SEL Log in Linear Storage / Circular Storage Policy ◆ Hardware Inventory ◆ Fan Profile ◆ System Firewall ◆ Power Consumption ◆ Power Control ◆ Advanced power capping ◆ LDAP / AD / RADIUS Support ◆ Backup & Restore Configuration ◆ Remote BIOS/BMC/CPLD Update ◆ Event Log Filter ◆ User Management ◆ Media Redirection Settings ◆ PAM Order Settings ◆ SSL Settings ◆ SMTP Settings
	Operating Properties <ul style="list-style-type: none"> ◆ Operating temperature: 10°C to 30°C ◆ Operating humidity: 8-80% (non-condensing) ◆ Non-operating temperature: -40°C to 60°C ◆ Non-operating humidity: 20%-95% (non-condensing) <p>NOTE!</p> <ul style="list-style-type: none"> ◆ To ensure system stability and prevent condensation, when the relative humidity exceeds 50%, the coolant inlet temperature must be higher than the dry-bulb temperature and it should not exceed 40°C.

1-4 CMC Hub Integrated Architecture

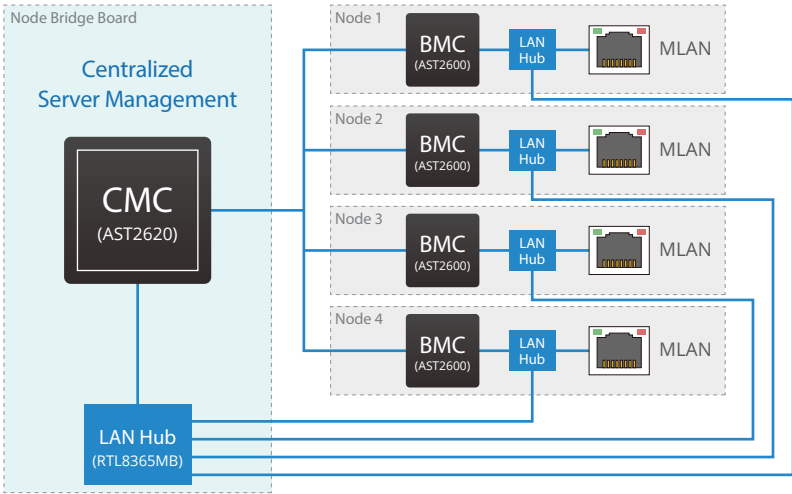

The CMC function can be accessed through any of the management LAN ports. Please set up the connection by using only one port on the server to connect to the switch. For examples of LAN configurations, please refer to Chapter 1-5.

1-5 Multiplexing Management Topology

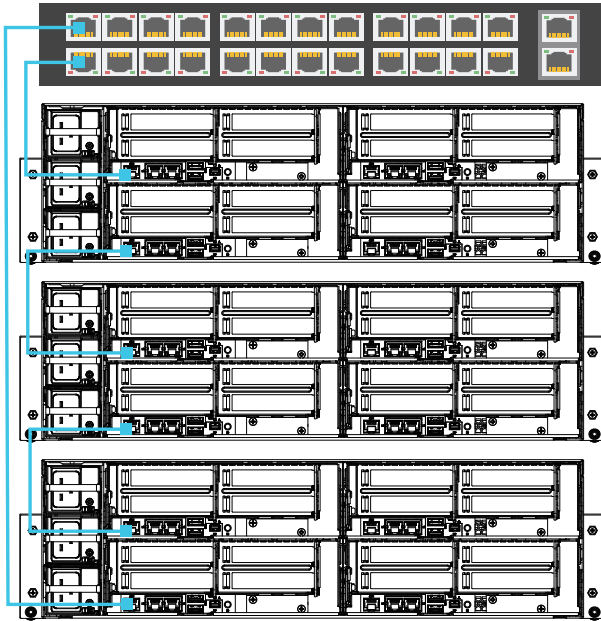

Spanning Tree Protocol (STP) must be enabled in LAN switch function if using ring topology.

LAN Switch and Compute Node Connection Example

Correct

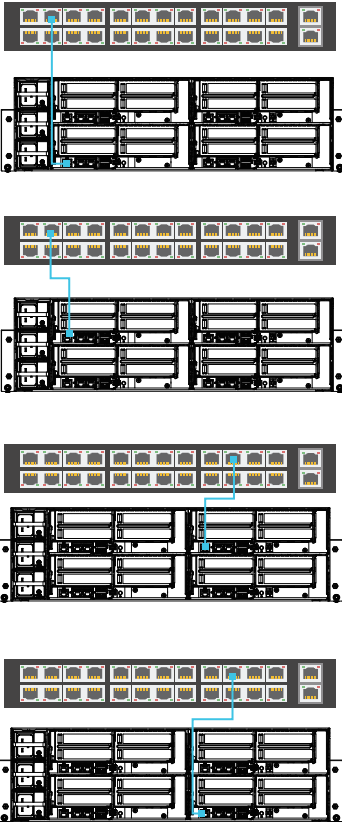

Incorrect

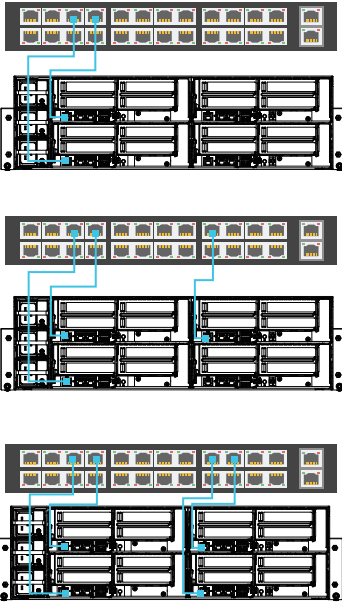

Chapter 2 System Appearance

2-1 Front View

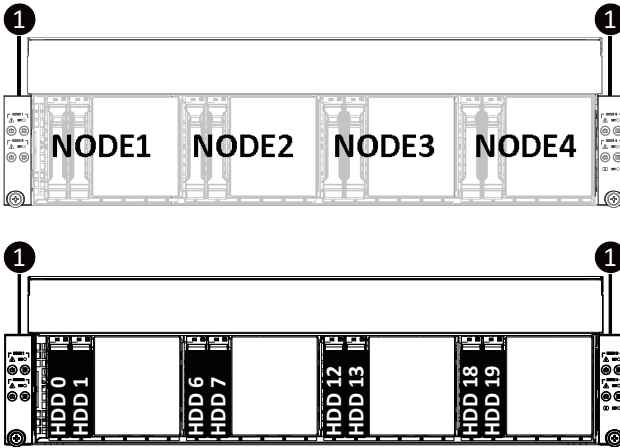



No.	Description
1.	Front Panel LEDs and buttons

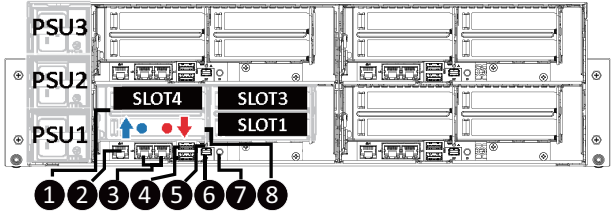

- Please Go to Chapter 2-3 Front Panel LED and Buttons for detail description of function LEDs.

2-2 Rear View



No.	Description		
1.	PCIe Card Slot		
2.	Management LAN Port		
3.	Data LAN Port x 2		
4.	USB 3.2 Gen1 x 2		
5.	Node System Status LED		
6.	Mini DisplayPort		
7.	ID Button with LED		
8.	Coolant Pipe slots		
	Coolant Supply		Coolant Return

2-3 Front Panel LED and Buttons

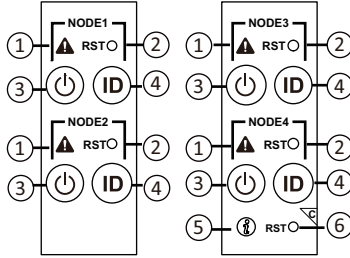

No.	Name	Color	Status	Description
1.	System Status LED ^(Note)			This LED represents the RoT function LED behavior. Please see the following section for detail LED behavior.
2.	Reset Button	--	--	Press this button to reset the system.
3.	Power button with LED	Green	On	System is powered on
		Green	Blink	System is in ACPI S1 state (sleep mode)
		N/A	Off	<ul style="list-style-type: none"> System is not powered on or in ACPI S5 state (power off) System is in ACPI S4 state (hibernate mode)
4.	ID Button with LED ^(Note)			This LED represents the RoT function LED behavior. Please see the following section for detail LED behavior.
5.	Enclosure	Green	On	System is operating normally.
		Amber	On	Critical condition, may indicates: Power module failure System fan failure Power supply voltage issue System temperature
			Blink	Non-critical condition, may indicates: Redundant power module failure Temperature and voltage issue
6.	CMC Reset Button	--	--	Press this button to reset the CMC.

(Note) If your server features RoT function, please see the following section for detail LED behavior.

2-4 RoT LEDs

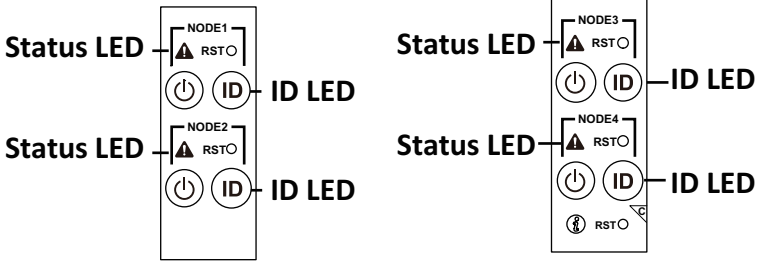

State	LED on Front Panel		LED on PRoT Module
	ID LED	Status LED	Live LED
AST1060 FW Active Authentication fail			
AST1060: Recovering active region	4Hz	Green and Amber Blink alternately at 4Hz [Green, Amber, Green, Amber, and so on]	4Hz
AST1060 FW Active and Recovery Authentication fail			
Endless attempts to boot from active or recovery.	On	Off	Off
Authenticating BMC/BIOS Images			
Authenticating Images	Off	Off	2Hz
BMC/BIOS Images Authentication Pass			
BMC : Authentication pass BIOS : Authentication pass	Off	Off	0.5Hz

State	LED on Front Panel		LED on PRoT Module
	ID LED	Status LED	Live LED
Recovering BMC/BIOS Images			
BMC : Recovering active region	4Hz	Green Blink at 4Hz	4Hz
BIOS : Recovering active region	4Hz	Amber Blink at 4Hz	4Hz
BMC : Recovering recovery region (If the staging region exists)	4Hz	Green On	4Hz
BIOS : Recovering recovery region (If the staging region exists)	4Hz	Amber On	4Hz
BMC/BIOS Images Active and Recovery region Authentication Fail			
BMC : Active and Recovery authentication fail	On	Green On	2Hz
BIOS : Active and Recovery authentication fail	On	Amber On	2Hz

NOTE!

1. When the BMC/BIOS starts, the LEDs will be controlled by the BMC/BIOS.

2-5 Rear System LAN LEDs

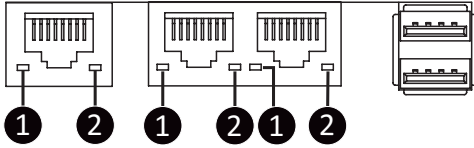

No.	Name	Color	Status	Description
1.	1GbE Speed LED	Yellow	On	1Gbps data rate
		Green	On	100 Mbps data rate
		N/A	Off	10 Mbps data rate
2.	1GbE Link/Activity LED	Green	On	Link between system and network or no access
			Blink	Data transmission or receiving is occurring
		N/A	Off	No data transmission or receiving is occurring

2-6 Power Supply Unit LED

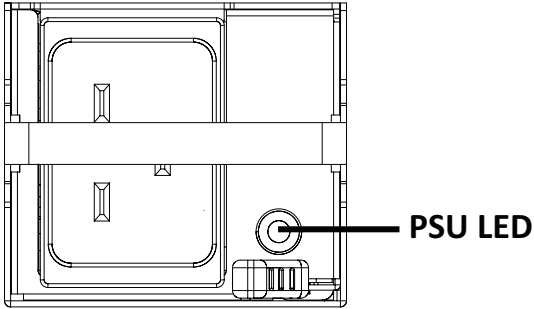

State	Description
OFF	No AC power to all power supplies
1Hz Green Blinking	AC present / only standby on / Cold redundant mode
2Hz Green Blinking	Power supply firmware update mode
Amber	AC cord unplugged or AC power lost; with a second power supply in parallel still with AC input power
	Power supply critical event causing shut down: failure, OCP, OVP, fan failure and UVP
1Hz Amber Blinking	Power supply warning events where the power supply continues to operate: high temp, high power, high current and slow fan

2-7 Hard Disk Drive LEDs

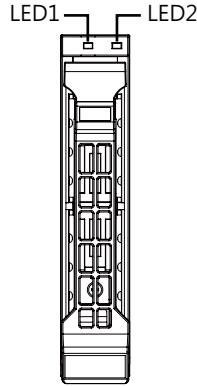

RAID SKU		LED1	Locate	HDD Fault	Rebuilding	HDD Access	HDD Present (No Access)
No RAID configuration (via HBA)	Disk LED (LED on Back Panel)	Green	ON(*1)	OFF		BLINK (*2)	OFF
		Amber	OFF	OFF		OFF	OFF
	Removed HDD Slot (LED on Back Panel)	Green	ON(*1)	OFF		--	--
		Amber	OFF	OFF		--	--
RAID configuration (via HW RAID Card or SW RAID Card)	Disk LED	Green	ON	OFF		BLINK (*2)	OFF
		Amber	OFF	ON	(Low Speed: 2 Hz)	OFF	OFF
	Removed HDD Slot	Green	ON(*1)	OFF	(*3)	--	--
		Amber	OFF	ON	(*3)	--	--

LED 2	HDD Present	No HDD
Green	ON	OFF

NOTE:

*1: Depends on HBA/Utility Spec.

*2: Blink cycle depends on HDD's activity signal.

*3: If HDD is pulled out during rebuilding, the disk status of this HDD is regarded as faulty.

Chapter 3 System Hardware Installation



Pre-installation Instructions

Computer components and electronic circuit boards can be damaged electrostatic discharge. Working on computers that are still connected to a power supply can be extremely dangerous. Follow the simple guidelines below to avoid damage to your computer or injury to yourself.

- Always disconnect the computer from the power outlet whenever you are working inside the computer case.
- If possible, wear a grounded wrist strap when you are working inside the computer case. Alternatively, discharge any static electricity by touching the bare metal system of the computer case, or the bare metal body of any other grounded appliance.
- Hold electronic circuit boards by the edges only. Do not touch the components on the board unless it is necessary to do so. Do not flex or stress the circuit board.
- Leave all components inside the static-proof packaging until you are ready to use the component for the installation.

3-1 Installing the Hard Disk Drive



Read the following guidelines before you begin to install the Hard disk drive:

- Take note of the drive tray orientation before sliding it out.
- The tray will not fit back into the bay if inserted incorrectly.
- Make sure that the HDD is connected to the HDD connector on the backplane.

Follow these instructions to install the Hard disk drive:

1. Press the release button.
2. Extend the locking lever.
3. Pull the locking lever to remove the HDD tray.
4. Align the hard disk drive with the positioning stud on the HDD tray.
5. Slide hard disk drive into the blank HDD tray.
6. Reinsert the HDD tray into the slot and close the locking lever.

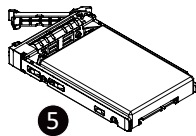
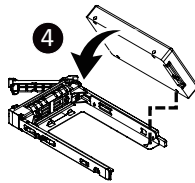
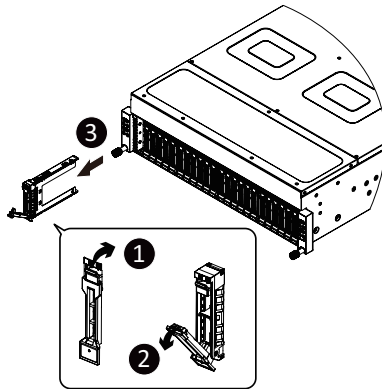

3-2 Removing the Node



Read the following guidelines before you begin to replace a node:

- To make sure the system operates normally, please power off only the node that will be replaced or reconfigured.

Follow these instructions to remove a node:

1. Press the release latch while simultaneously pushing down the tray handle for the node.
2. Pull the node out of the system.
3. To install the node, push the node back into the system.

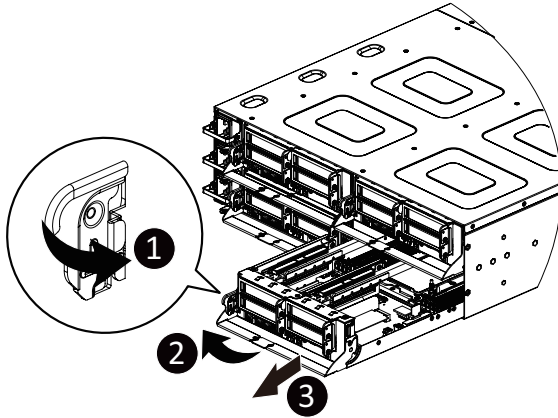

3-3 How to Get the BMC Password

Follow these instructions to get the BMC Password:

1. Pull out the tab and then you can find the password information on the tab.

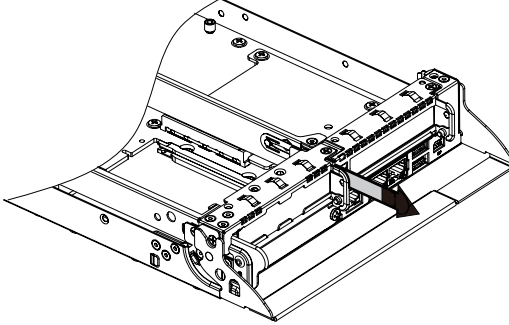

3-4 Removing Chassis Cover



Before you remove or install the system cover

- Make sure the system is not turned on or connected to AC power.

Follow these instructions to remove the system cover:

1. Loosen and remove the eight screws securing the back cover.
2. Slide the cover to the rear of the system and remove the cover in the direction of the arrow.

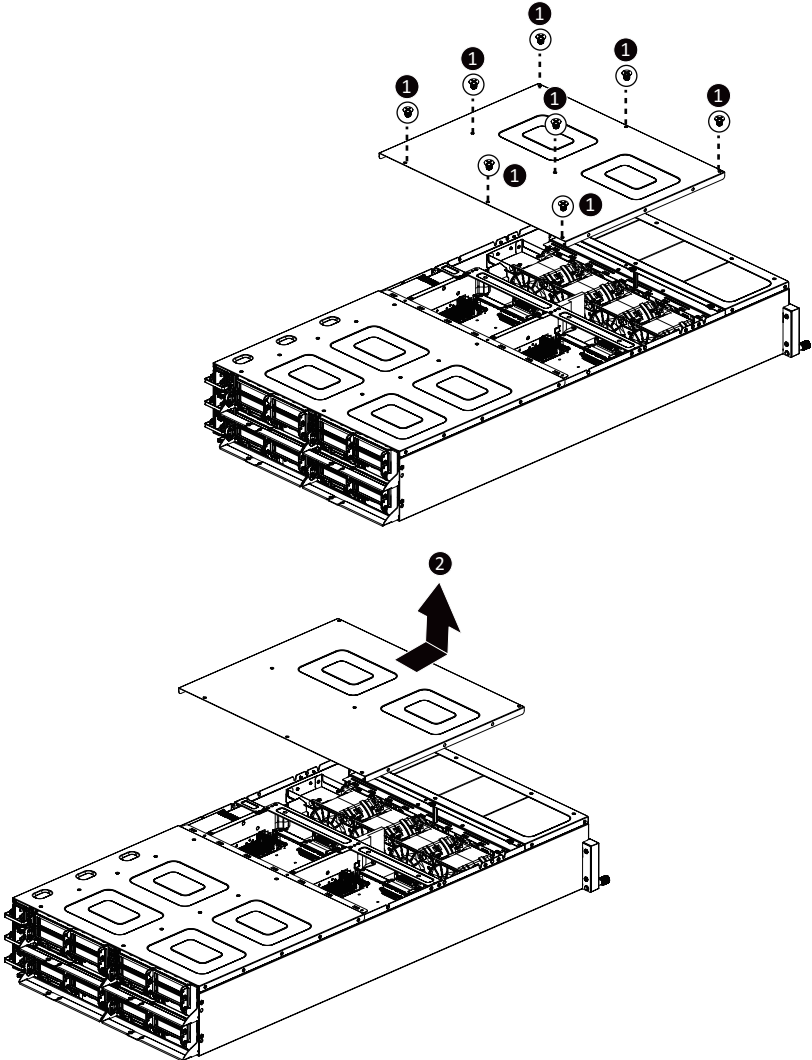

3-5 Liquid Cooling Assembly Information

The liquid cooling assembly is designed to capture heat from the processors in the node and cool the components. The coolant flow for the assembly is produced by the eight quick disconnects at the rear of the server chassis.

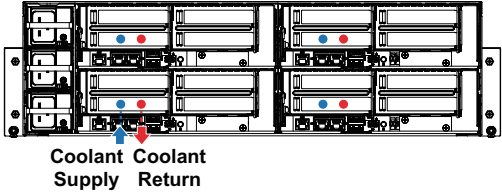

The flow of the coolant is shown below:

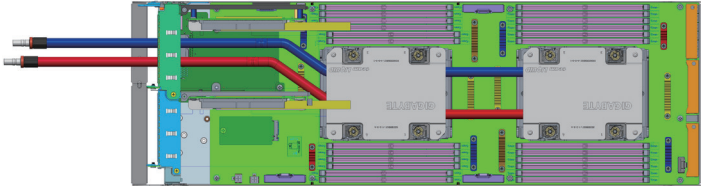

Flow Order	Component
First	Coolant into CPU
Third	CPU coolant return

3-5-1 Liquid Cooling Specifications

The cold plate assembly in the liquid cooling assembly mounts directly on top of the processors.

The retention mechanism for installation on top of the processors is integrated into the cold plate. The liquid coolant contained within the tubes, is a mixture of demineralized water and propylene glycol with the following beneficial features: Anti-Freeze, Anti-Corrosion and Anti Bacterial. The following table lists the features and specifications of the liquid cooling assembly.

Specification	Value
Cold plate material	Copper CDA110
Thermal Interface Material	Shin-Etsu X23-8079-2 (CPU)
Operating liquid temperature	Minimum: 5°C Maximum: 70°C
Operating Air temperature	40°C
Coolant Flow Rate	1.65 LPM Typical (CPU)
Operating Humidity	5 - 90%
Storage Temperature	-40°C to 70°C
Dimensions	
Height	23.4 mm
Weight	CPU 3.086 lbs (1400g)

NOTE:

- The ambient temperature and relative humidity of the environment depend on the inlet supply water temperature and the coolant flow rate.
- If the relative humidity surpasses 60%, maintain the inlet water temperature between 40°C and 45°C to prevent condensation and ensure optimal system performance.

3-6 Removing the Coolant Pipe Module



Read the following guidelines before you begin to install the module:

- Always turn off the computer and unplug the power cord from the power outlet before installing the module to prevent hardware damage.
- Unplug all cables from the power outlets.
- Disconnect all telecommunication cables from their ports.
- Place the system unit on a flat and stable surface.
- Open the system according to the instructions.

WARNING!

Failure to properly turn off the server before you start installing components may cause serious damage. Do not attempt the procedures described in the following sections unless you are a qualified service technician.

Follow these instructions to remove the coolant pipe module:

1. Remove the left PCIe riser before removing the CPU coolant module. To remove PCIe bracket, see page 43 3-10 Installing the PCI Expansion Card.
2. Loosen the four captive screws securing the coolant pipe module to the system.
3. Lift and remove the coldplate and the left PCIe riser.



- Lock the CPU coolant by using a T30-Lobe driver to tighten screw.*
- When installing the coolant to CPU, use T30-Lobe driver to tighten 4 captive nuts in sequence as 1-4.
- For cable connection, please go to Page 47 3-13 Cable Routing.

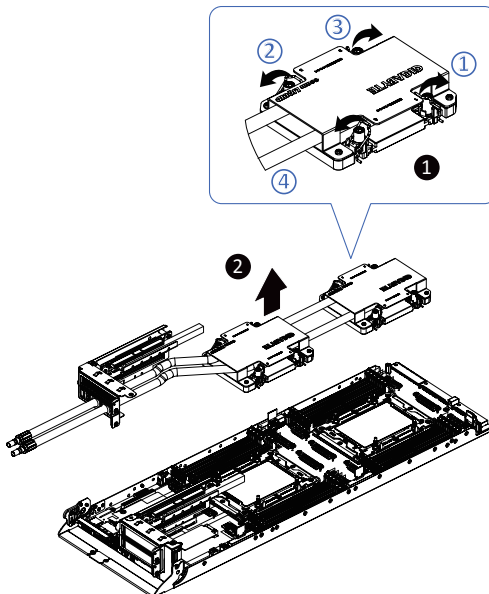

3-7 Installing the CPU and the Coolant Pipe Module



Read the following guidelines before you begin to install the CPU:

- Make sure that the motherboard supports the CPU.
- Always turn off the computer and unplug the power cord from the power outlet before installing the CPU to prevent hardware damage.
- Unplug all cables from the power outlets.
- Disconnect all telecommunication cables from their ports.
- Place the system unit on a flat and stable surface.
- Open the system according to the instructions.



WARNING!

Failure to properly turn off the server before you start installing components may cause serious damage. Do not attempt the procedures described in the following sections unless you are a qualified service technician.

Follow these instructions to install the CPU:

1. Align the processor to the carrier so that the gold triangle on the processor aligns with the triangle on the carrier, and then install the processor into the carrier.
NOTE: Apply thermal compound evenly on the top of the CPU.
2. Remove the CPU socket cover.
NOTE: Save and replace the CPU socket cover if the processor is removed from its socket.

NOTE!

- The carrier code is marked on each carrier and matches a code laser marked on to the IHS(Integrated Heat Spreader) to ensure the right parts are used together.
- When installing the coolant pipe module to CPU, use T30-Lobe driver to tighten 4 captive nuts in sequence as 1-4.
- The screw tightening torque: 8 ± 0.5 kgf-cm.

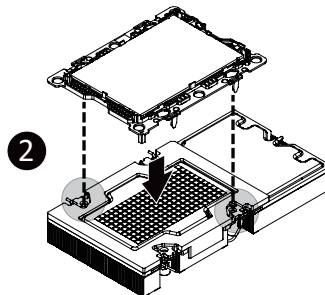
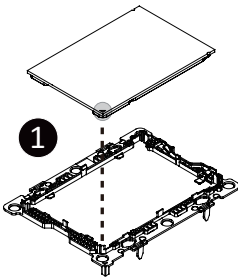

3. Loosen the four captive screws securing the carrier assembly to the system.
4. Put the Coolant pipe through the PCIe 1 bracket and put the PCIe bracket and coolant bracket together. Use the retained screw to lock the PCIe 1 bracket.
5. Attach the support bracket to the pipe slots.
6. Secure the bracket and the slots with one screw.
7. Align the carrier assembly to the CPU socket using the guide pins and make sure the gold triangle is in the correct orientation. Then place the carrier assembly onto the top of the CPU socket. Secure the carrier assembly by tightening the screws in sequential order (1→2→3→4).
8. For cable connection, please go to Page 48 3-13 Cable Routing.

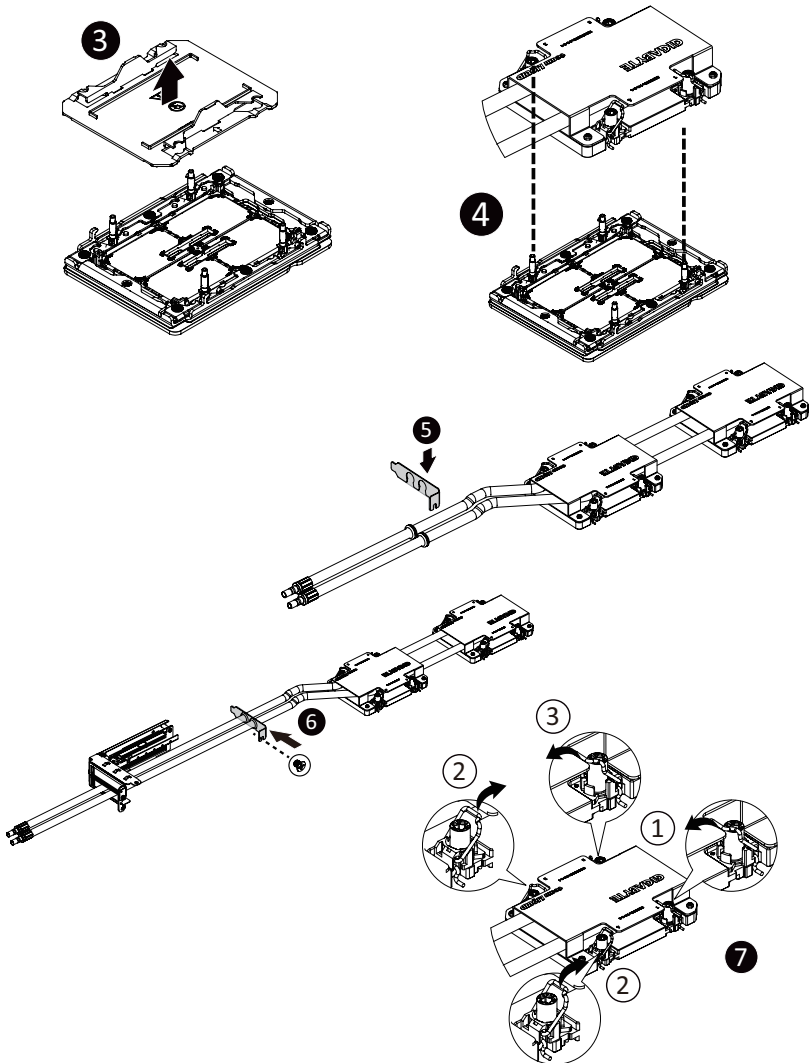

3-8 Installing Memory



Read the following guidelines before you begin to install the memory:

- Make sure that the motherboard supports the memory. It is recommended that memory of the same capacity, brand, speed, and chips be used.
- Always turn off the computer and unplug the power cord from the power outlet before installing the memory to prevent hardware damage.
- Memory modules have a foolproof design. A memory module can be installed in only one direction. If you are unable to insert the memory, switch the direction.

3-8-1 Twelves Channel Memory Configuration

This motherboard provides 24 DDR5 memory sockets and supports Twelves Channel Technology. After the memory is installed, the BIOS will automatically detect the specifications and capacity of the memory.

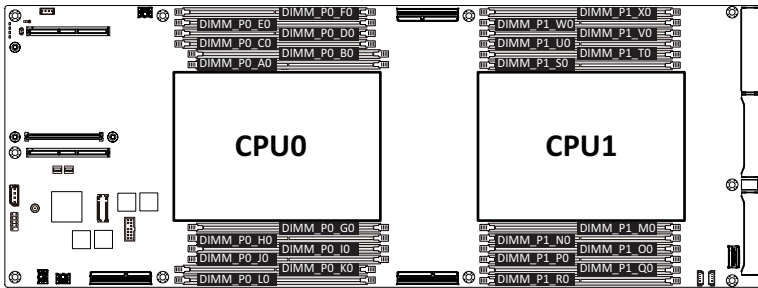

3-8-2 Installing the Memory



Before installing a memory module, make sure to turn off the computer and unplug the power cord from the power outlet to prevent damage to the memory module.

Be sure to install DDR5 DIMMs on this motherboard.

Follow these instructions to install the Memory:

1. Insert the DIMM memory module vertically into the DIMM slot, and push it down.
2. Close the plastic clip at both edges of the DIMM slots to lock the DIMM module.
3. Reverse the installation steps when you want to remove the DIMM module.

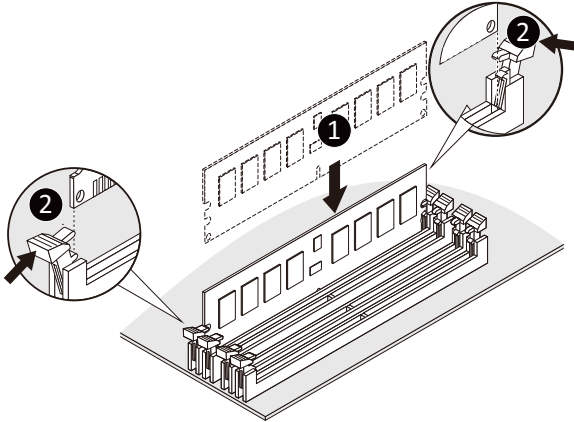

3-8-3 DIMM Population Table

Intel Xeon 6900E-Series Memory Support

Type	Ranks Per DIMM and Data Width	DIMM Capacity (GB)			Channel Speed (MT/s); Voltage (V); Slots per Channel (SPC) & DIMMs per Channel (DPC)
		DRAM Density			1DPC/2SPC
		16Gb	24Gb	32Gb	1.1V
RDIMM	1Rx4	32GB	48GB		6400, 6000, 5600, 5200, 4800 (DDR5-6400 rated RDIMMS only)
	2Rx4	64GB	96GB	128GB	
RDIMM 3DS	8Rx4	256GB			

Intel Xeon 6900E-Series CXL Memory Support

Native DDR5 Memory Per Socket				CXL Memory Per Socket				
Slot 0 DIMM Ranks	Slot 0 DIMM Capacity (GB)	DIMM Type	DRAM Density (Gb)	CXL Memory Channels	CXL Memory Type	CXL Capacity Per Device/ Module	CXL Interleave	CXL Mode
2Rx4	64	10x4	16	1+1	DDR5 x16	2ch 64 GB	Hetero x 16	Hetero
1Rx4	32	10x4	16	1+1+1	DDR5 x16	2ch 64 GB	1x3 (BIOS)	1LM+Intel® Flat Memory Mode

NOTE:

- Intel Xeon 6900E-series CXL memory configs are 1DPC only for native DDR5
- CXL Memory Channel notation: # of devices per root port, with root ports separated by "+". i.e. 2+2+2+2 = four root ports populated with two devices per root port
- CXL Interleave notation: sets x ways. i.e. 2x4 = two sets of four-way interleaves
- CXL Modes:
 - 1LM+Vol = DDR5 and CXL memory visible to SW as separate tiers, separately interleaved
 - Hetero = DDR5 and CXL memory interleaved together in one 16-way set
 - Flat2LM = HW manages data movement between DDR5 and CXL memory, total capacity visible to SW

Intel Xeon 6900P-Series Memory Support

Type	Ranks Per DIMM and Data Width	DIMM Capacity (GB)			Channel Speed (MT/s); Voltage (V); Slots per Channel (SPC) & DIMMs per Channel Density (DPC)
		DRAM Density			1DPC/1SPC
		16Gb	24Gb	32Gb	1.1V
RDIMM	1Rx4	32GB	48GB		6400, 6000, 5600, 5200, 4800 (DDR5-6400 rated RDIMMS only)
	2Rx8	32GB	48GB		
	2Rx4	64GB	96GB	128GB*	
RDIMM 3DS	8Rx4	256GB			
MCR DIMM	2Rx8	32GB			8800, 8000, 7200 (MRDIMM-8800 only)
	2Rx4	64GB	48GB		
	4Rx8	64GB	96GB	128GB	
	4Rx4 (2U)	128GB	96GB		
	4Rx4 (2U)			256GB	

Intel Xeon 6900P-Series CXL Memory Support

Native DDR5 Memory Per Socket				CXL Memory Per Socket				
Slot0 DIMM Ranks	Slot0 DIMM Capacity (GB)	DIMM Type	DRAM Density (Gb)	CXL Memory Channels	CXL Memory Type	CXL Capacity Per Device/ Module	CXL Interleave	CXL Mode
2Rx4	64	10x4	16	1+1	DDR5 x16	2ch 64 GB	hetero x16	Hetero
2Rx4	64	10x4	16	2+2+2+2	DDR5 x8	64 GB	1x8*, 2x4, 4x2	1LM+Vol
2Rx4	64	10x4	16	1+1+1	DDR4 x8	128 GB	1x3 (BIOS)	1LM+Intel® Flat Memory Mode

NOTE:

- Intel Xeon 6900P-series processors CXL memory configs are 1DPC only ('Slot 0') for native DDR5
- CXL Memory Channel notation: # of devices per root port, with root ports separated by "+". i.e. 2+2+2+2 = four root ports
- populated with two devices per root port
- CXL Interleave notation: sets x ways. i.e. 2x4 = Set of two modules, interleaved four-way
- CXL Modes:
 - 1LM+Vol = Native DDR5 ('1LM') and (volatile) CXL memory visible to SW as separate tiers, separately interleaved
 - Hetero x16 = DDR5 and (volatile) CXL memory interleaved together in one 16-way set (See graphic in next slide)
 - Flat Memory Mode = HW manages data movement between DDR5 and CXL memory, total capacity visible to SW

3-8-4 Processor and Memory Module Matrix Table

Memory Q'ty for each CPU	CPU0												CPU1																	
	L0	K0	J0	I0	H0	G0	E0	A0	B0	C0	D0	E0	F0	X0	W0	V0	U0	T0	S0	M0	N0	O0	P0	Q0	R0					
1 DIMM								v																		v				
8 DIMM	v	v	v	v						v	v	v	v	v	v	v	v										v	v	v	v
		v	v		v	v		v	v			v	v			v	v		v	v	v	v						v	v	
	v			v	v	v		v	v	v			v	v				v	v	v	v	v	v							v
12 DIMM	v	v	v	v	v	v	v	v	v	v	v	v	v	v	v	v	v	v	v	v	v	v	v	v	v	v	v	v	v	v

3-9 Installing the PCI Expansion Card



- The PCI riser assembly does not include a riser card or any cabling as standard. To install a PCI card, a riser card must be installed.

Follow these instructions to remove the left PCI Expansion bracket:

1. Remove the four screw on the riser bracket to the system.
2. Lift up the riser bracket out of system.
3. Remove the one screw securing the riser bracket to the system.
4. Lift up the riser bracket out of left riser.

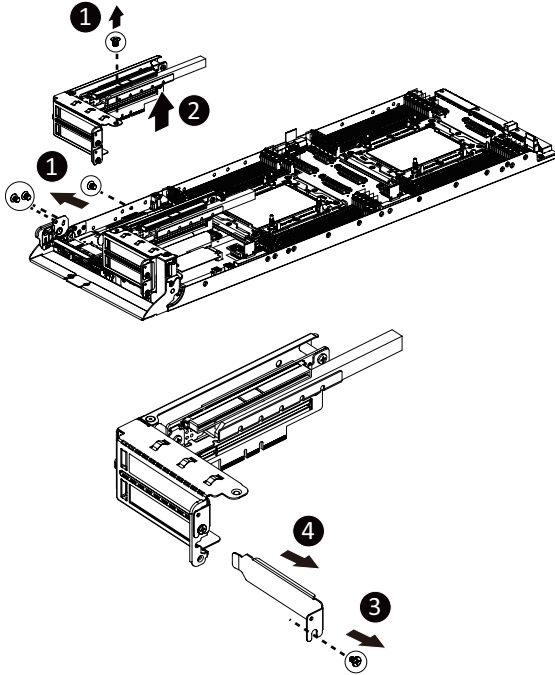

Follow these instructions to install the right PCI Expansion card:

1. Remove the three screws on the riser bracket to the system.
2. Lift up the riser bracket out of system.
3. Remove the screw securing the side bracket to the riser bracket.
4. Remove the side bracket
5. Align the PCIe card to the riser guide slot and push in the direction of the arrow until the PCI-E card sits in the PCI card connector.
6. Secure the PCIe card with a screw.
7. Install the side bracket to the riser bracket.
8. Secure the side bracket to the riser bracket with a screw.
9. Reverse steps 1 - 2 to install the riser bracket back into the system.

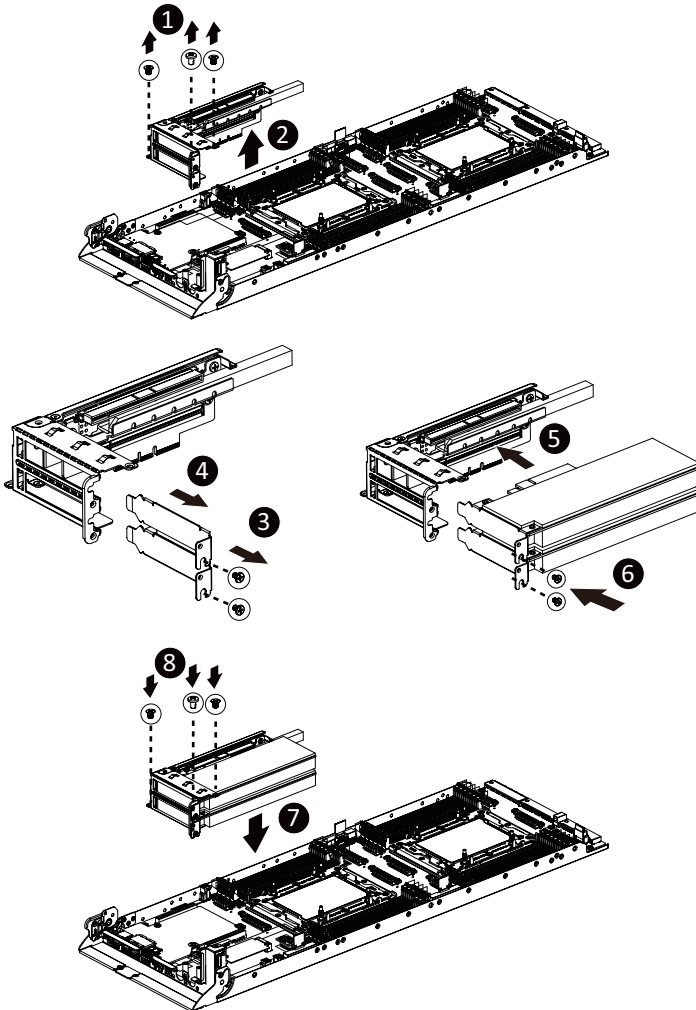

3-10 Removing and Installing the Rear IO Card

Follow these instructions to install the Rear IO card:

1. Remove the three screws securing the Rear IO card to the system.
2. Lift up the Rear IO card out of system.
3. Reverse steps 1 - 2 to install the Rear IO card back into the system.

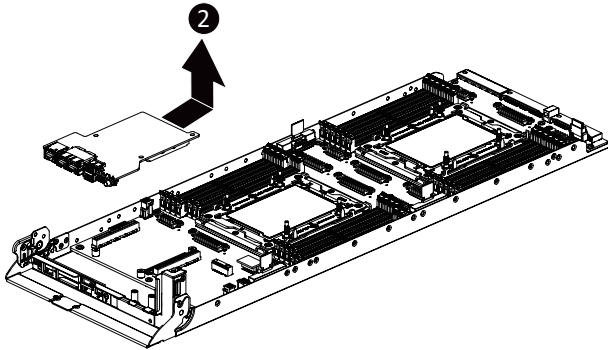
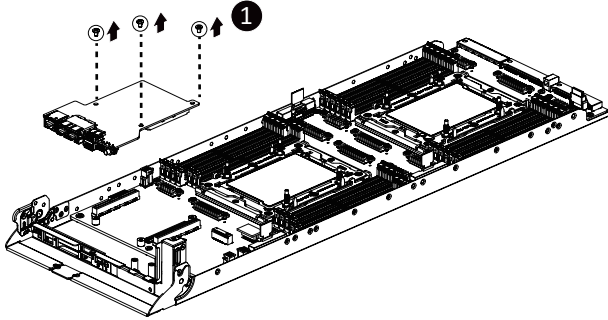

3-11 Replacing the Fan Assembly



- Voltages can be present within the server whenever an AC power source is connected. This voltage is present even when the main power switch is in the off position. Ensure that the system is powered-down and all power sources have been disconnected from the server prior to replacing a system fan.

Failure to observe these warnings could result in personal injury or damage to equipment.

Follow these instructions to replace the fan assembly:

1. Remove the three screws on the support bracket to the system.
2. Lift up the support bracket and remove it from the system.
3. Lift up the fan assembly from the chassis.
4. Reverse the previous steps to install the replacement fan assembly.

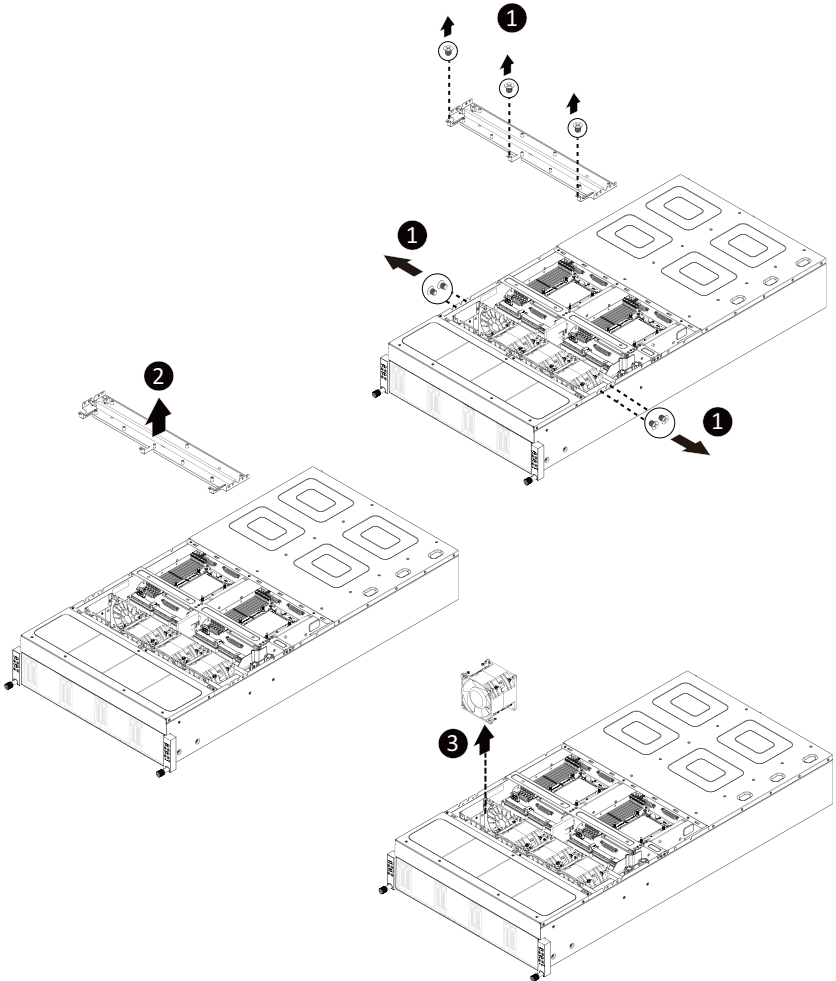

3-12 Replacing the Power Supply

Follow these instructions to replace the power supply:

1. Pull up the power supply handle and press the retaining clip on the right side of the power supply along the direction of the arrow. At the same time, pull out the power supply by using its handle.
2. Insert the replacement power supply firmly into the chassis. Connect the AC power cord to the replacement power supply.

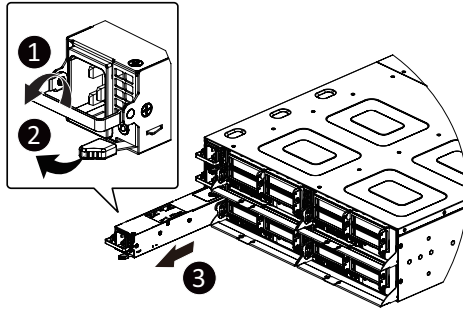

3-13 Cable Routing

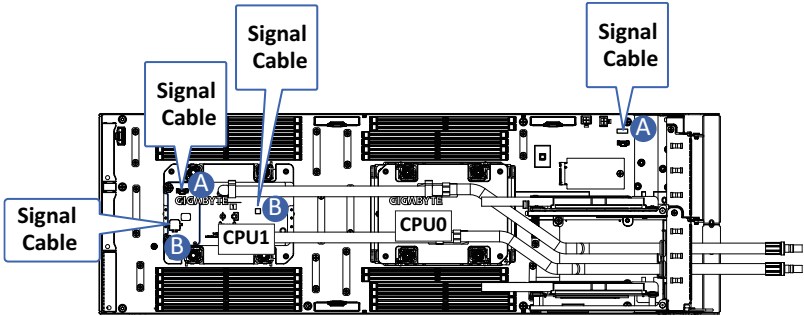

A	LEAK Sensor Cable	Motherboard: LEAK_CON
		Sensor Board: OUT1
B	LEAK Sensor Cable	Sensor Board: BH_1
		CPU1 Coldplate: --

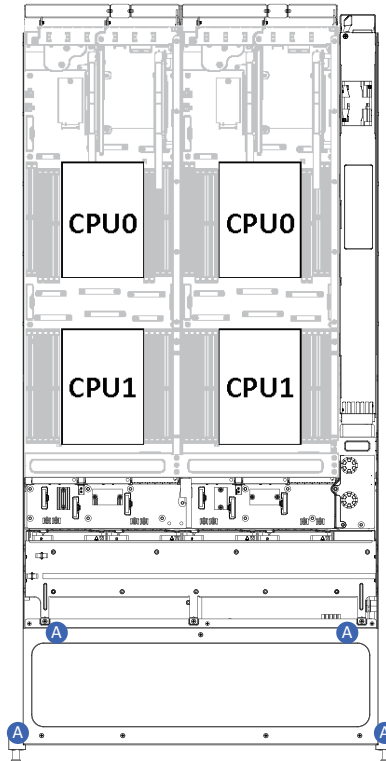

A	Front Panel LEDs and Buttons Cable	Motherboard: FP_1 Front IO Board: FP_1
		Front IO Board: FP_1

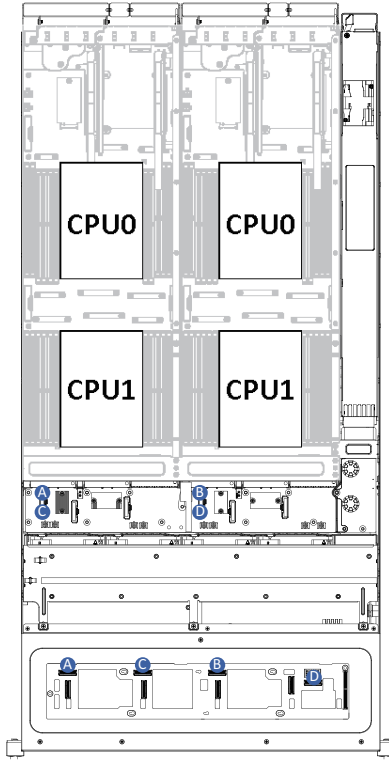

A	Top Middle Board to HDD Back Plane Board Cable (SATA1)	Middle Board: N1_SATA
		Front HDD Board: N1 SATA
B	Top Middle Board to HDD Back Plane Board Cable (SATA3)	Middle Board: N3_SATA
		Front HDD Board: N3 SATA
C	Bottom Middle Board to HDD Back Plane Board Cable (SATA2)	Middle Board: N2_SATA
		Front HDD Board: N2 SATA
D	Bottom Middle Board to HDD Back Plane Board Cable (SATA4)	Middle Board: N4_SATA
		Front HDD Board: N4 SATA

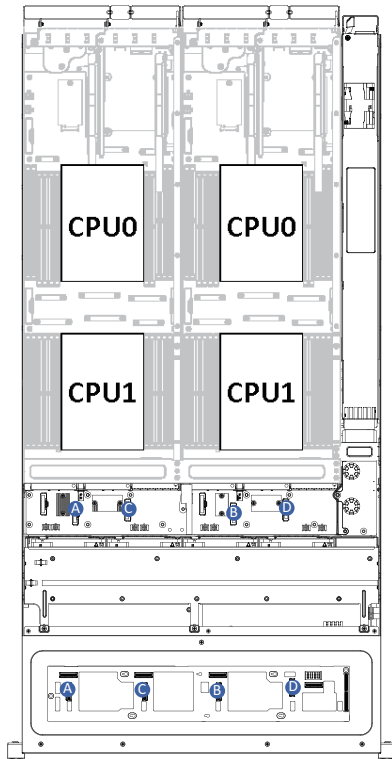

A	Top Middle Board to HDD Back Plane Board Cable (NVMe/Node1)	Middle Board: N1_U2_A
		Front HDD Board: N1 U.2 A
B	Top Middle Board to HDD Back Plane Board Cable (NVMe/Node3)	Middle Board: N3_U2_A
		Front HDD Board: N3 U.2 A
C	Bottom Middle Board to HDD Back Plane Board Cable (NVMe/Node2)	Middle Board: N2_U2_A
		Front HDD Board: N2 U.2 A
D	Bottom Middle Board to HDD Back Plane Board Cable (NVMe/Node4)	Middle Board: N4_U2_A
		Front HDD Board: N4 U.2 A

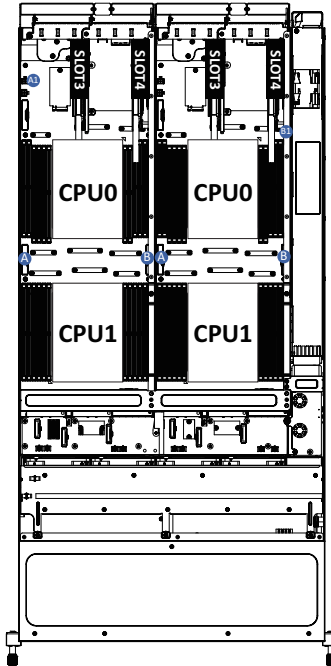
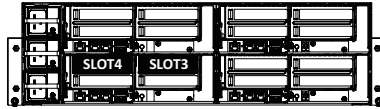

A	System PCIe Cable	PCIe Riser Bracket: Slot 3
		Motherboard: A: U2_P1_PE4 A1: SLOT4_PWR
B	System PCIe Cable	PCIe Riser Bracket: Slot 4
		Motherboard: B: U2_P1_PE5 B1: SLOT3_PWR

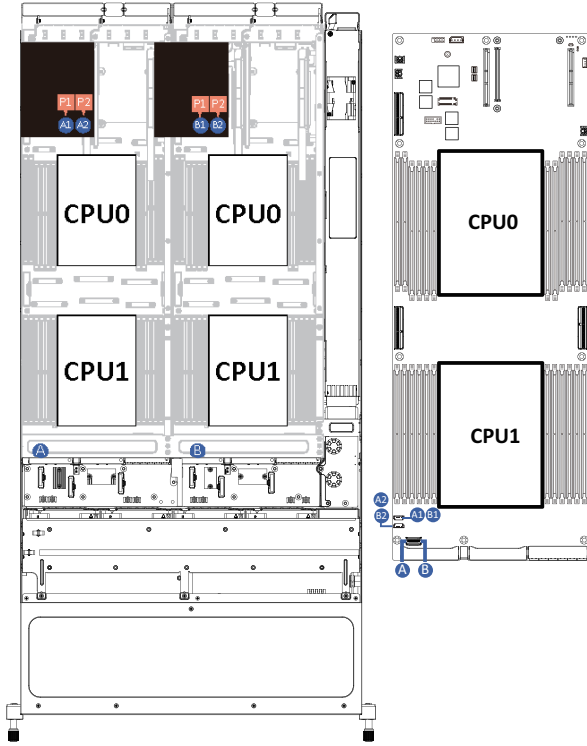

A	SAS RAID Card Cable (Optional)	Motherboard: MCIO_SATA A1: SGPA A2: SGPB
		RAID Card: A1: SAS 0-3 A2: SAS 4-7
B		Motherboard: MCIO_SATA B1: SGPA B2: SGPB
		RAID Card: A1: SAS 0-3 A2: SAS 4-7

Chapter 4 Motherboard Components

4-1 Motherboard Components

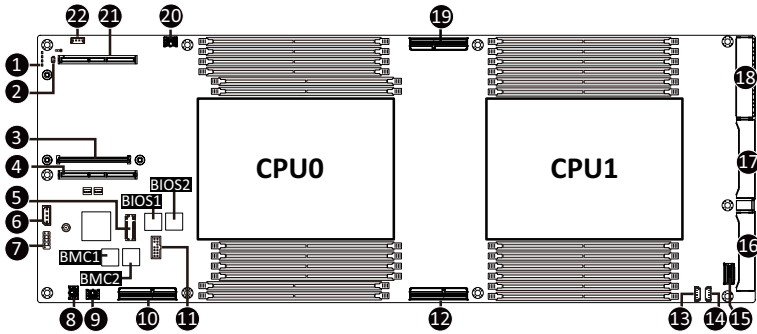

Item	Description
1	BMC Firmware Readiness LED
2	System Battery Cable Connector
3	IO Card Slot for IO Board
4	Proprietary PCIe Slot (Gen 5/ x16 slot/ GENZ_2)
5	PRoT Module Connector (M.2 M-Key/only enabled on RoT SKU)
6	IPMB Connector
7	Serial Port Cable Connector
8	PCIe Power Connector for U2_P1_PE4 (SLOT4_PWR)
9	PCIe Power Connector for U2_P0_PE1 (SLOT5_PWR/Reserved)
10	MCIO Connector (PCIe Gen5 x16 /U2_P0_PE1)
11	TPM Module Connector
12	MCIO Connector (U2_P1_PE4/PCIe Gen5)
13	SGPIO Connector (SGPA)
14	SGPIO Connector (SGPB)
15	MCIO Connector (SATA/SATA Signal)
16	PCIe/SATA Connector
17	PCIe Connector
18	Power Connector
19	MCIO Connector (U2_P1_PE5/PCIe Gen5)
20	PCIe Power Connector for U2_P1_PE5 (SLOT3_PWR)
21	Proprietary PCIe Slot (Gen 5/ x16 slot/ GENZ_1)
22	VROC Module Connector

4-2 Jumper Setting

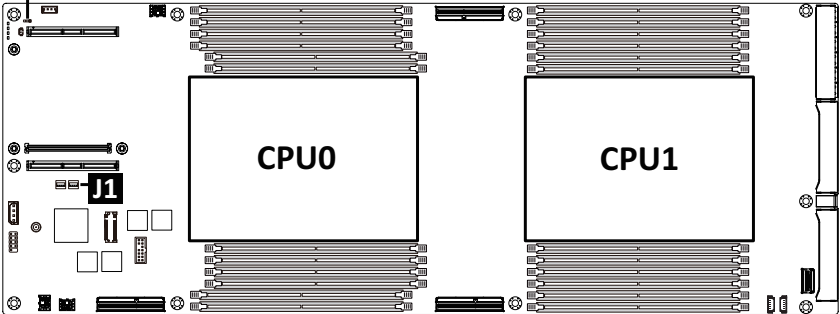
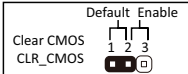

J1		ON	OFF
1	S3_MASK	Stop initial power on when BMC is not ready	Normal [Default]
2	BIOS_RCVR	BIOS recovery mode	Normal [Default]
3	BIOS_PWD	Clear supervisor password	Normal [Default]
4	RST BMC_EN	ID button to enable BMC reset	Normal [Default]

4-3 Backplane Board Storage Connector

4-3-1 CBPH081

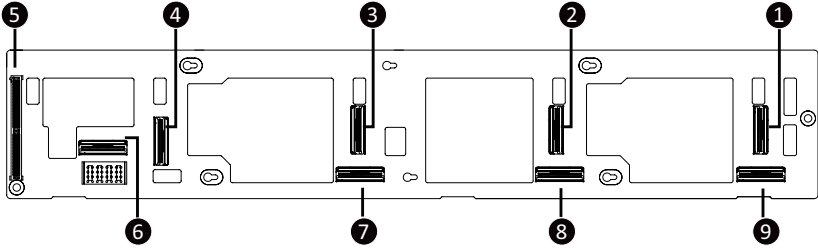

Item	Description
1	MCIO 8i (SFF-TA1016/N1 U.2 A)
2	MCIO 8i (SFF-TA1016/N2 U.2 A)
3	MCIO 8i (SFF-TA1016/N3 U.2 A)
4	MCIO 8i (SFF-TA1016/N4 U.2 A)
5	Proprietary PCIe Slot (x8 slot/ GF_HDD1)
6	MCIO 8i (SFF-TA1016/N4 SATA)
7	MCIO 8i (SFF-TA1016/N3 SATA)
8	MCIO 8i (SFF-TA1016/N2 SATA)
9	MCIO 8i (SFF-TA1016/N1 SATA)

Chapter 5 BIOS Setup

BIOS (Basic Input and Output System) records hardware parameters of the system in the EFI on the motherboard. Its major functions include conducting the Power-On Self-Test (POST) during system startup, saving system parameters, loading the operating system etc. The BIOS includes a BIOS Setup program that allows the user to modify basic system configuration settings or to activate certain system features. When the power is turned off, the battery on the motherboard supplies the necessary power to the CMOS to keep the configuration values in the CMOS.

To access the BIOS Setup program, press the key during the POST when the power is turned on.



- BIOS flashing is potentially risky, if you do not encounter any problems when using the current BIOS version, it is recommended that you don't flash the BIOS. To flash the BIOS, do it with caution. Inadequate BIOS flashing may result in system malfunction.
- It is recommended that you not alter the default settings (unless you need to) to prevent system instability or other unexpected results. Inadequately altering the settings may result in system's failure to boot. If this occurs, try to clear the CMOS values and reset the board to default values. (Refer to the **Exit** section in this chapter or introductions of the battery/clearing CMOS jumper in Chapter 4 for how to clear the CMOS values.)

BIOS Setup Program Function Keys

<<-><->>	Move the selection bar to select the screen
<↑><↓>	Move the selection bar to select an item
<+>	Increase the numeric value or make changes
<->	Decrease the numeric value or make changes
<Enter>	Execute command or enter the submenu
<Esc>	Main Menu: Exit the BIOS Setup program Submenus: Exit current submenu
<F1>	Show descriptions of general help
<F3>	Restore the previous BIOS settings for the current submenus
<F9>	Load the Optimized BIOS default settings for the current submenus
<F10>	Save all the changes and exit the BIOS Setup program

■ **Main**

This setup page includes all the items of the standard compatible BIOS.

■ **Advanced**

This setup page includes all the items of AMI BIOS special enhanced features.

(ex: Auto detect fan and temperature status, automatically configure hard disk parameters.)

■ **Chipset**

This setup page includes all the submenu options for configuring the functions of the Platform Controller Hub.

■ **Server Management**

Server additional features enabled/disabled setup menus.

■ **Security**

Change, set, or disable supervisor and user password. Configuration supervisor password allows you to restrict access to the system and BIOS Setup.

A supervisor password allows you to make changes in BIOS Setup.

A user password only allows you to view the BIOS settings but not to make changes.

■ **Boot**

This setup page provides items for configuration of the boot sequence.

■ **Save & Exit**

Save all the changes made in the BIOS Setup program to the CMOS and exit BIOS Setup. (Pressing <F10> can also carry out this task.)

Abandon all changes and the previous settings remain in effect. Pressing <Y> to the confirmation message will exit BIOS Setup. (Pressing <Esc> can also carry out this task.)

5-1 The Main Menu

Once you enter the BIOS Setup program, the Main Menu (as shown below) appears on the screen. Use arrow keys to move among the items and press <Enter> to accept or enter other sub-menu.

Main Menu Help

The on-screen description of a highlighted setup option is displayed on the bottom line of the Main Menu.

Submenu Help

While in a submenu, press <F1> to display a help screen (General Help) of function keys available for the menu. Press <Esc> to exit the help screen. Help for each item is in the Item Help block on the right side of the submenu.



- When the system is not stable as usual, select the **Restore Defaults** item to set your system to its defaults.
- The BIOS Setup menus described in this chapter are for reference only and may differ by BIOS version.

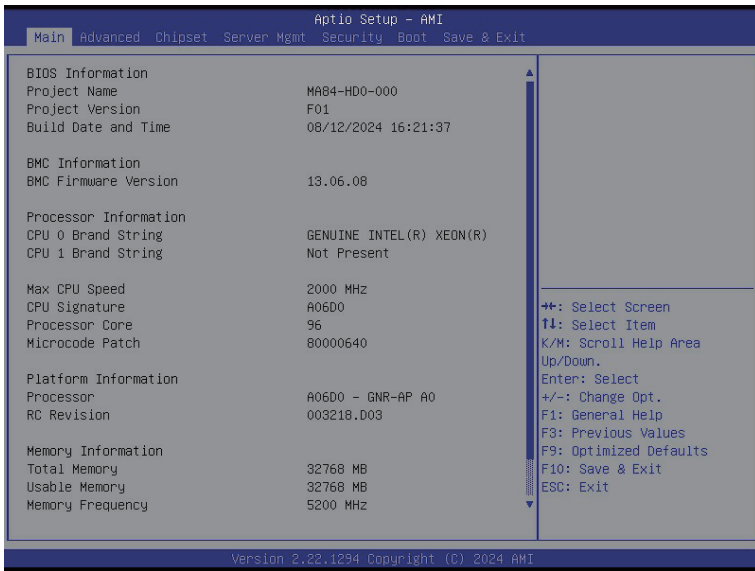

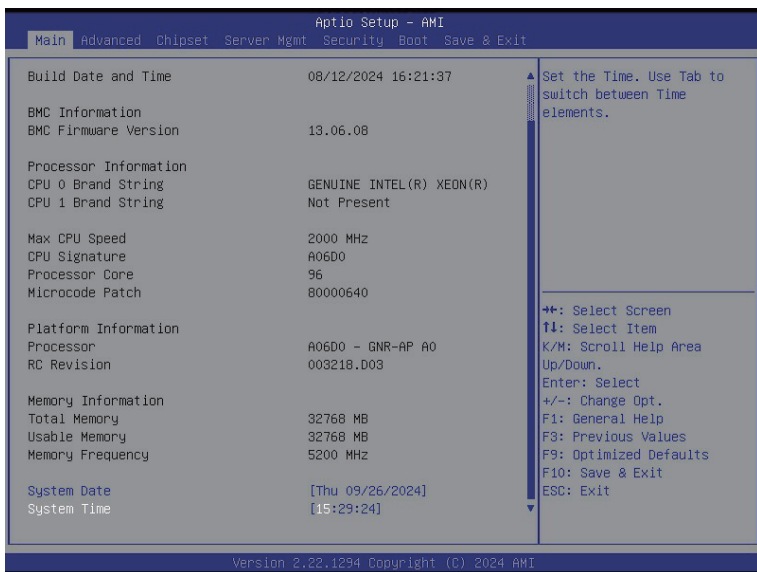

Parameter	Description
Project Name	Displays the project name information.
Project Version	Displays version number of the BIOS setup utility.
Build Date and Time	Displays the date and time when the BIOS setup utility was created.
BMC Information	
BMC Firmware Version	Displays BMC firmware version information.
Processor Information	
CPU Brand String/ Max CPU Speed / CPU Signature / Processor Core / Microcode Patch	Displays the technical information for the installed processor(s).
Platform Information	
Processor/RC Revision	Displays the information of the installed processor(s).
Memory Information ^(Note2)	
Total Memory	Displays the total memory size of the installed memory.
Usable Memory	Displays the usable memory size of the installed memory.
Memory Frequency	Displays the installed memory frequency information.

(Note1) Functions available on selected models.

(Note2) This section will display capacity and frequency information of the memory that the customer has installed.

Parameter	Description
System Date	Sets the date following the weekday-month-day-year format.
System Time	Sets the system time following the hour-minute-second format.

5-2 Advanced Menu

The Advanced Menu displays submenu options for configuring the function of various hardware components. Select a submenu item, then press <Enter> to access the related submenu screen.

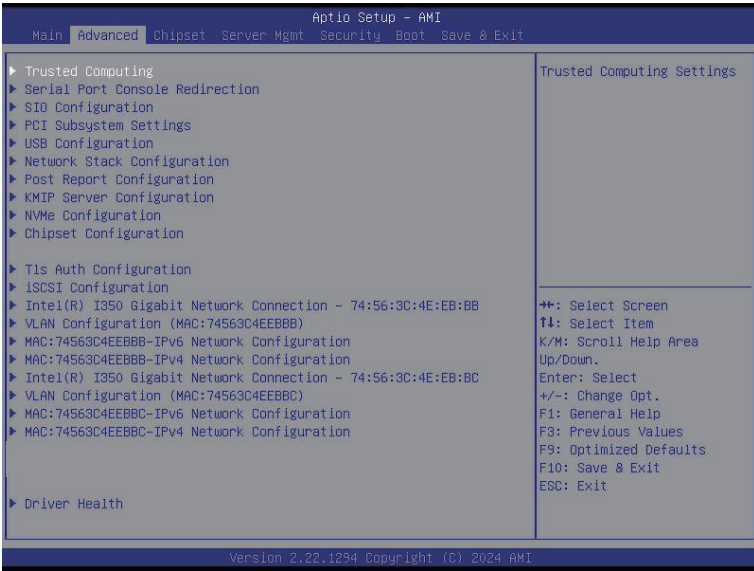

5-2-1 Trusted Computing

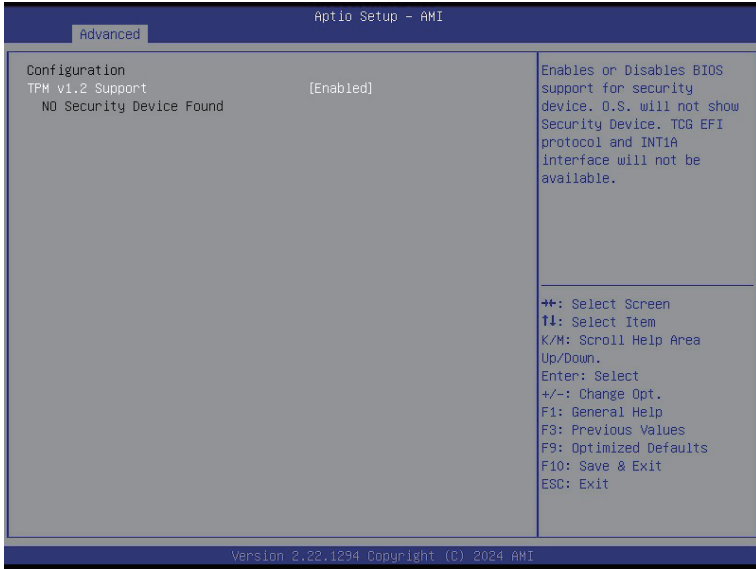

Parameter	Description
Configuration	
TPM v1.2 Support	<p>Enable/Disable BIOS support for security device. OS will not show security device. TCG EFI protocol and INT1A interface will not be available.</p> <p>Options available: Disable, Enable. Default setting is Enable.</p>

5-2-2 Serial Port Console Redirection

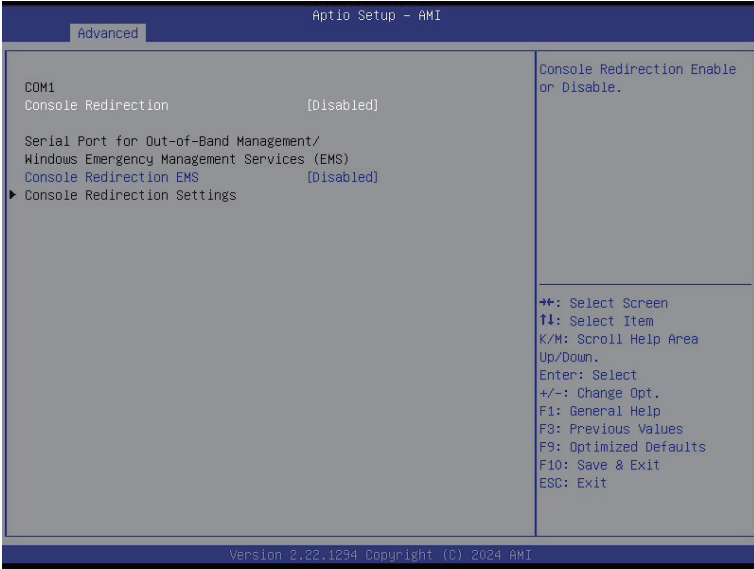

Parameter	Description
COM1 Console Redirection ^(Note)	<p>Console redirection enables the users to manage the system from a remote location.</p> <p>Options available: Enabled, Disabled. Default setting is Disabled.</p>
COM1 Console Redirection Settings	<p>Press [Enter] to configure advanced items.</p> <p>Please note that this item is configurable when COM1 Console Redirection is set to Enabled.</p> <ul style="list-style-type: none"> ◆ Terminal Type <ul style="list-style-type: none"> – Selects a terminal type to be used for console redirection. – Options available: VT100, VT100PLUS, VT-UTF8, ANSI. Default setting is VT100PLUS. ◆ Bits per second <ul style="list-style-type: none"> – Selects the transfer rate for console redirection. – Options available: 9600, 19200, 38400, 57600, 115200. Default setting is 115200. ◆ Data Bits <ul style="list-style-type: none"> – Selects the number of data bits used for console redirection. – Options available: 7, 8. Default setting is 8.

(Note) Advanced items prompt when this item is defined.

Parameter	Description
COM1 Console Redirection Settings (continued)	<ul style="list-style-type: none"> ◆ Parity <ul style="list-style-type: none"> – A parity bit can be sent with the data bits to detect some transmission errors. – Even: parity bit is 0 if the num of 1's in the data bits is even. – Odd: parity bit is 0 if num of 1's in the data bits is odd. – Mark: parity bit is always 1. Space: Parity bit is always 0. – Mark and Space Parity do not allow for error detection. – Options available: None, Even, Odd, Mark, Space. Default setting is None. ◆ Stop Bits <ul style="list-style-type: none"> – Stop bits indicate the end of a serial data packet. (A start bit indicates the beginning). The standard setting is 1 stop bit. Communication with slow devices may require more than 1 stop bit. – Options available: 1, 2. Default setting is 1. ◆ Flow Control <ul style="list-style-type: none"> – Flow control can prevent data loss from buffer overflow. When sending data, if the receiving buffers are full, a 'stop' signal can be sent to stop the data flow. Once the buffers are empty, a 'start' signal can be sent to re-start the flow. Hardware flow control uses two wires to send start/stop signals. – Options available: None, Hardware RTS/CTS. Default setting is None. ◆ VT-UTF8 Combo Key Support <ul style="list-style-type: none"> – Enable/Disable the VT-UTF8 Combo Key Support. – Options available: Enabled, Disabled. Default setting is Enabled. ◆ Recorder Mode <ul style="list-style-type: none"> – When this mode enabled, only texts will be send. This is to capture Terminal data. – Options available: Enabled, Disabled. Default setting is Disabled. ◆ Resolution 100x31 <ul style="list-style-type: none"> – Enable/Disable extended terminal resolution. – Options available: Enabled, Disabled. Default setting is Enabled. ◆ Putty Keypad <ul style="list-style-type: none"> – Selects Function Key and Keypad on Putty. – Options available: VT100, LINUX, XTERMR6, SC0, ESCN, VT400. Default setting is VT100.

Parameter	Description
Serial Port for Out-of-Band Management / Windows Emergency Management Services (EMS) Console Redirection ^(Note)	<p>EMS console redirection allows the user to configure Console Redirection Settings to support Out-of-Band Serial Port management.</p> <p>Options available: Enabled, Disabled. Default setting is Disabled.</p>
Serial Port for Out-of-Band EMS Console Redirection Settings	<p>Press [Enter] to configure advanced items.</p> <p>Please note that this item is configurable when Serial Port for Out-of-Band Management EMS Console Redirection is set to Enabled.</p> <ul style="list-style-type: none"> ◆ Out-of-Band Mgmt Port <ul style="list-style-type: none"> – Microsoft Windows Emergency Management Service (EMS) allows for remote management of a Windows Server OS through a serial port. – Default setting is COM1. ◆ Terminal Type EMS <ul style="list-style-type: none"> – Selects a terminal type to be used for console redirection. – Options available: VT100, VT100PLUS, VT-UTF8, ANSI. Default setting is VT100PLUS. ◆ Bits per second EMS <ul style="list-style-type: none"> – Selects the transfer rate for console redirection. – Options available: 9600, 19200, 57600, 115200. Default setting is 115200. ◆ Flow Control EMS <ul style="list-style-type: none"> – Flow control can prevent data loss from buffer overflow. When sending data, if the receiving buffers are full, a 'stop' signal can be sent to stop the data flow. Once the buffers are empty, a 'start' signal can be sent to re-start the flow. Hardware flow control uses two wires to send start/stop signals. – Options available: None, Hardware RTS/CTS, Software Xon/Xoff. Default setting is None.

5-2-3 SIO Configuration



Parameter	Description
AMI SIO Driver Version	Displays the AMI SIO driver version information.
Super IO Chip Logical Device(s) Configuration	
[*Active*] Serial Port	<p>Press [Enter] to configure advanced items.</p> <ul style="list-style-type: none"> ◆ Use This Device <ul style="list-style-type: none"> – When set to Enabled allows you to configure the serial port settings. When set to Disabled, displays no configuration for the serial port. – Options available: Enabled, Disabled. Default setting is Enabled. ◆ Logical Device Settings/Current: <ul style="list-style-type: none"> – Displays the serial port base I/O address and IRQ. ◆ Possible: <ul style="list-style-type: none"> – Configures the serial port base I/O address and IRQ. <ul style="list-style-type: none"> Use Automatic Settings IO=3F8h; IRQ=4; DMA; IO=3F8h; IRQ=4; DMA; IO=2F8h; IRQ=4; DMA; IO=3E8h; IRQ=4; DMA; IO=2E8h; IRQ=4; DMA; Default setting is Use Automatic Settings.

5-2-4 PCI Subsystem Settings



Parameter	Description
PCI Bus Driver Version	Displays the PCI Bus Driver version information.
SLOT_# I/O ROM ^(Note1)	When enabled, this setting will initialize the device expansion ROM for the related PCI-E slot. Options available: Enabled, Disabled. Default setting is Enabled .
SLOT_# Lanes ^(Note1)	Change the PCIe lanes. Default setting is Auto .
SLOT_#_Max Link Speed ^(Note1)	Configure PCIe max link speed. Options available: Auto, Gen1, Gen2, Gen3, Gen4, Gen5. Default setting is Auto .
U2_P0_# I/O ROM ^(Note2)	Enable/Disable M2A I/O ROM. Options available: Enabled, Disabled. Default setting is Enabled .
U2_P0_# Lanes ^(Note2)	Change the M2 PCIe lanes. Default setting is Auto .
U2_P0_#_Max Link Speed ^(Note2)	Configure M2 PCIe max link speed. Options available: Auto, Gen1, Gen2, Gen3, Gen4, Gen5. Default setting is Auto .
LAN I/O ROM ^(Note3)	Enable/Disable the LAN devices, and initializes device expansion ROM. Options available: Enabled, Disabled. Default setting is Enabled .

(Note1) This section is dependent on the available PCIe Slot.

(Note2) This section is dependent on the available U2 Slot.

Parameter	Description
PCI Devices Common Settings	
Re-Size BAR Support	If system has Resizable BAR capable PCIe Devices, this option Enables or Disables Resizable BAR Support. Options available: Enabled, Disabled. Default setting is Disabled .
SR-IOV Support	If the system has SR-IOV capable PCIe devices, this item Enable/Disable Single Root IO Virtualization Support. Options available: Enabled, Disabled. Default setting is Enabled .

5-2-5 USB Configuration

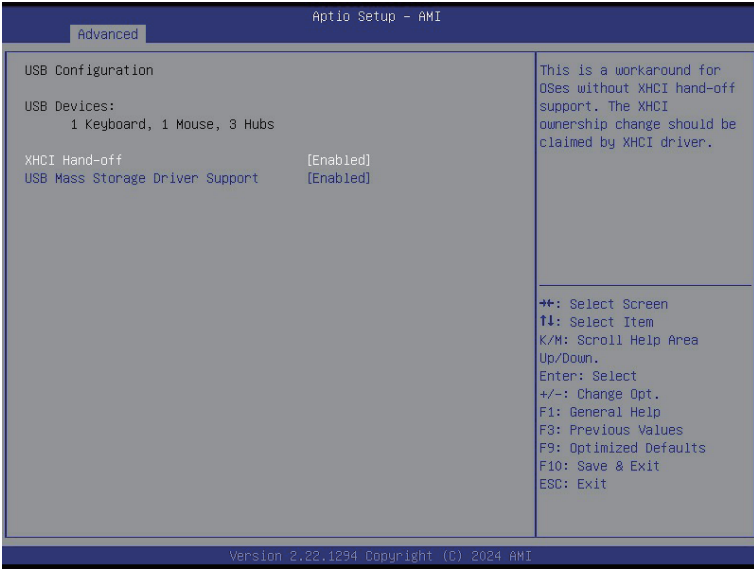

Parameter	Description
USB Configuration	
USB Devices:	Displays the USB devices connected to the system.
XHCI Hand-off	Enable/Disable the XHCI (USB 3.0) Hand-off support. Options available: Enabled, Disabled. Default setting is Enabled .
USB Mass Storage Driver Support ^(Note)	Enable/Disable the USB Mass Storage Driver Support. Options available: Enabled, Disabled. Default setting is Enabled .

(Note) This item is present only if you attach USB devices.

5-2-6 Network Stack Configuration

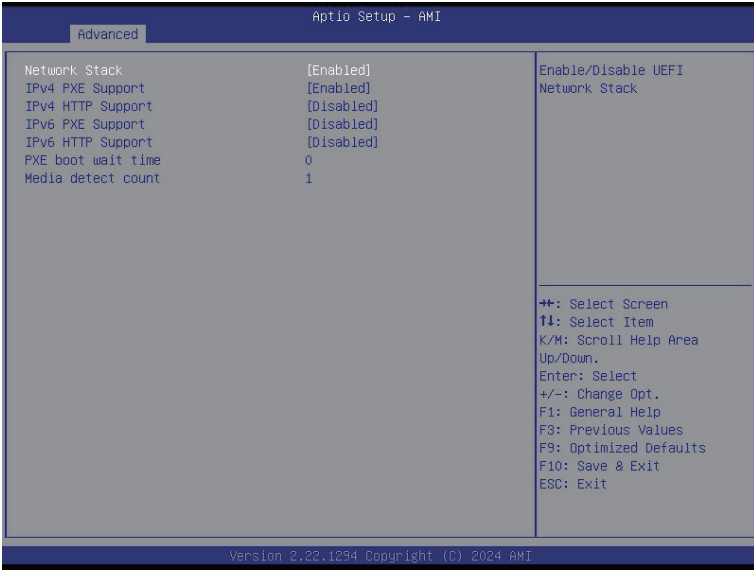

Parameter	Description
Network Stack	Enable/Disable the UEFI network stack. Options available: Enabled, Disabled. Default setting is Enabled .
Ipv4 PXE Support	Enable/Disable the Ipv4 PXE feature. Options available: Enabled, Disabled. Default setting is Enabled .
Ipv4 HTTP Support	Enable/Disable the Ipv4 HTTP feature. Options available: Enabled, Disabled. Default setting is Disabled .
Ipv6 PXE Support	Enable/Disable the Ipv6 PXE feature. Options available: Enabled, Disabled. Default setting is Disabled .
Ipv6 HTTP Support	Enable/Disable the Ipv6 HTTP feature. Options available: Enabled, Disabled. Default setting is Disabled .
PXE boot wait time	Wait time in seconds to press ESC key to abort the PXE boot. Press the <+> / <-> keys to increase or decrease the desired values.
Media detect count	Number of times the presence of media will be checked. Press the <+> / <-> keys to increase or decrease the desired values.

5-2-7 Post Report Configuration

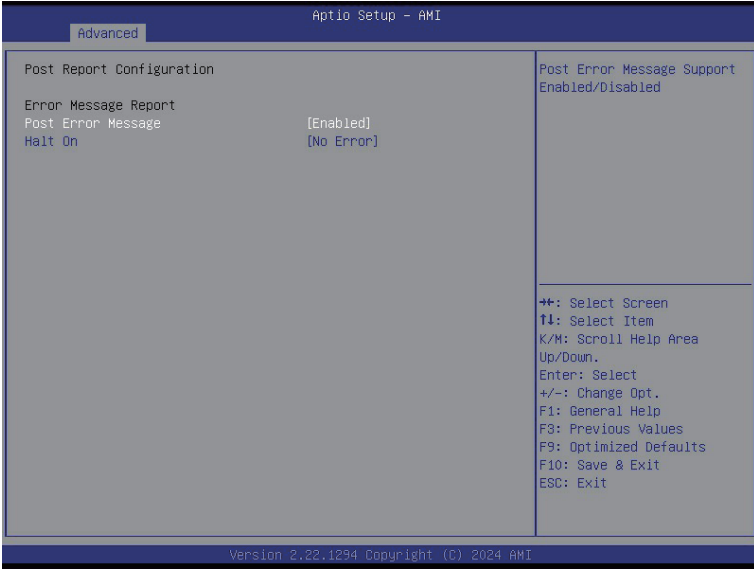

Parameter	Description
Post Report Configuration	
Error Message Report	
Post Error Message	Enable/Disable the POST Error Message support. Options available: Enabled, Disabled. Default setting is Enabled .
Halt On	Options available: No Error, All Error. Default setting is No Error .

5-2-8 KMIP Server Configuration

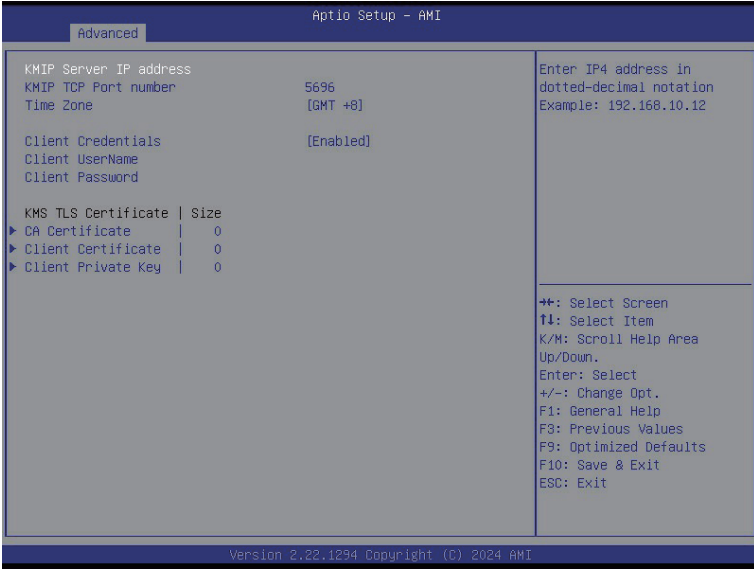

Parameter	Description
KMIP Server IP address	
KMIP TCP Port Number	
Time Zone	Enter the correct timem zone for this server. Default setting is GMT+8 .
Client Credentials	Use User and password credentials to authenticate the Client. Options available: Enabled, Disabled, Clear. Default setting is Enabled .
Client UserName	Enter Client identify: UserName. Name Length: 0-63 characters.
Client Password	Enter Client identify: Password. Password Length: 0-31 characters.
KMS TLS Certificate / Size	
CA Certificate	Enroll factory defaults or load the KMS TLS certificates from the file.
Client Certificate	Enroll factory defaults or load the KMS TLS certificates from the file.
Client Private Key	Enroll factory defaults or load the KMS TLS certificates from the file.

5-2-9 NVMe Configuration



Parameter	Description
NVMe Configuration	Displays the NVMe devices connected to the system.

5-2-10 Chipset Configuration



Parameter	Description
Restore on AC Power Loss ^(Note)	Defines the power state to resume to after a system shutdown that is due to an interruption in AC power. When set to Last State, the system will return to the active power state prior to shutdown. When set to Power Off, the system remains off after power shutdown. Options available: Last State, Power Off, Power On, Unspecified. The default setting depends on the BMC setting.
P2P Bridge IO Size	Specifies P2P Bridge IO aligned to the size. Options available: 0x100, 0x150, 0x1000. Default setting is 0x1000 .
SATA HDD Security Frozen	Enable/Disable this item to send freeze lock command to SATA HDD. Options available: Enabled, Disabled. Default setting is Enabled .
NVMe SSD Security Frozen	Attempt to send freeze lock command to NVMe SSDs during boot. Options available: Enabled, Disabled. Default setting is Enabled .
NVMe OPROM Select	BIOS Build-In is default setting. Select Device Itself, then this NVMe page will not display any device. Unless the device doesn't have OPROM. Options available: BIOS Build-In, NVMe Device, Disables. Default setting is BIOS Build-In .
NVMe LED Control	Enable/Disable allow user control NVMe LED. It only available the NVMe device direct connect to CPU. Default setting is Disable .

(Note) When the power policy is controlled by BMC, please wait for 15-20 seconds for BMC to save the last power state.

5-2-11 Tls Auth Configuration

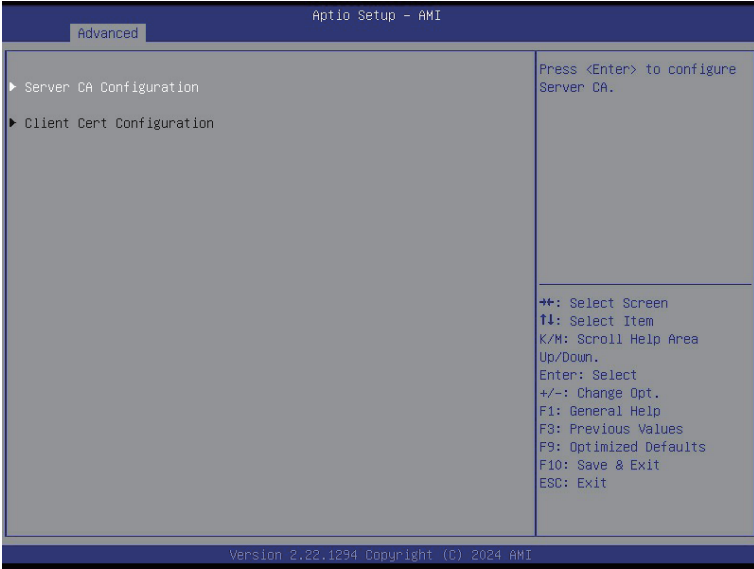

Parameter	Description
Server CA Configuration	<p>Press [Enter] for configuration of advanced items.</p> <ul style="list-style-type: none"> ◆ Enroll Cert <ul style="list-style-type: none"> - Press [Enter] to enroll a certificate <ul style="list-style-type: none"> • Enroll Cert Using File • Cert GUID <ul style="list-style-type: none"> Input digit character in 1111111-2222-3333-4444-1234567890ab format. - Commit Changes and Exit - Discard Changes and Exit ◆ Delete Cert
Client Cert Configuration	Press [Enter] for configuration of advanced items.

5-2-12 iSCSI Configuration

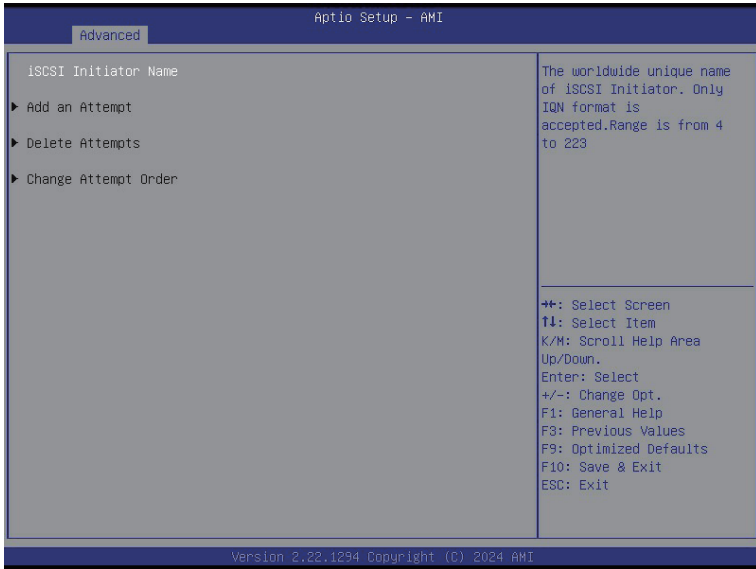

Parameter	Description
Host iSCSI Configuration	<p>Press [Enter] to configure advanced items.</p> <ul style="list-style-type: none"> ◆ iSCSI Initiator Name <ul style="list-style-type: none"> – Only IQN format is accepted. Range: from 4 to 223 ◆ Add an Attempt ◆ Delete Attempts ◆ Change Attempt Order

5-2-13 Intel(R) i350 Gigabit Network Connection

Aptio Setup - AMI		
Advanced		
<p>▶ NIC Configuration</p> <p>Blink LEDs 0</p> <p>UEFI Driver Intel(R) PRO/1000 8.5.21 PCI-E</p> <p>Adapter PBA 211015-010</p> <p>Device Name Intel(R) I350 Gigabit Network Connection</p> <p>Chip Type Intel i350</p> <p>PCI Device ID 1521</p> <p>PCI Address 15:00:00</p> <p>Link Status [Disconnected]</p> <p>MAC Address 74:56:3C:4E:EB:BB</p> <p>Virtual MAC Address 00:00:00:00:00:00</p>		<p>Click to configure the network device port.</p> <hr/> <p>←+: Select Screen ↑↓: Select Item K/M: Scroll Help Area Up/Down. Enter: Select +/-: Change Opt. F1: General Help F8: Previous Values F9: Optimized Defaults F10: Save & Exit ESC: Exit</p>
Version 2.22.1294 Copyright (C) 2024 AMI		

Aptio Setup - AMI		
Advanced		
<p>Link Speed [Auto Negotiated]</p> <p>Wake On LAN [Enabled]</p>		<p>Specifies the port speed used for the selected boot protocol.</p> <hr/> <p>←+: Select Screen ↑↓: Select Item K/M: Scroll Help Area Up/Down. Enter: Select +/-: Change Opt. F1: General Help F8: Previous Values F9: Optimized Defaults F10: Save & Exit ESC: Exit</p>
Version 2.22.1294 Copyright (C) 2024 AMI		

Parameter	Description
NIC Configuration	<p>Press [Enter] to configure advanced items.</p> <ul style="list-style-type: none"> ◆ Link Speed <ul style="list-style-type: none"> – Allows for automatic link speed adjustment. – Options available: Auto Negotiated, 10 Mbps Half, 10 Mbps Full, 100 Mbps Half, 100 Mbps Full. Default setting is Auto Negotiated. ◆ Wake On LAN <ul style="list-style-type: none"> – Enables power on of the system via LAN. Note that configuring Wake on LAN in the operating system does not change the value of this setting, but does override the behavior of Wake on LAN in OS controlled power states. – Options available: Enabled, Disabled. Default setting is Enabled.
Blink LEDs	<p>Identifies the physical network port by blinking the associated LED. Press the numeric keys to adjust desired values (up to 15 seconds).</p>
UEFI Driver	Displays the technical specifications for the Network Interface Controller.
Adapter PBA	Displays the technical specifications for the Network Interface Controller.
Device Name	Displays the technical specifications for the Network Interface Controller.
Chip Type	Displays the technical specifications for the Network Interface Controller.
PCI Device ID	Displays the technical specifications for the Network Interface Controller.
PCI Address	Displays the technical specifications for the Network Interface Controller.
Link Status	Displays the technical specifications for the Network Interface Controller.
MAC Address	Displays the technical specifications for the Network Interface Controller.
Virtual MAC Address	Displays the technical specifications for the Network Interface Controller.

5-2-14 VLAN Configuration



Parameter	Description
Enter Configuration Menu	<p>Press [Enter] to configure advanced items.</p> <ul style="list-style-type: none"> ◆ Create new VLAN ◆ VLAN ID <ul style="list-style-type: none"> – Sets VLAN ID for a new VLAN or an existing VLAN. – Press the <+> / <-> keys to increase or decrease the desired values. – The valid range is from 0 to 4094. ◆ Priority <ul style="list-style-type: none"> – Sets 802.1Q Priority for a new VLAN or an existing VLAN. – Press the <+> / <-> keys to increase or decrease the desired values. – The valid range is from 0 to 7. ◆ Add VLAN <ul style="list-style-type: none"> – Press [Enter] to create a new VLAN or update an existing VLAN. ◆ Configured VLAN List ◆ Remove VLAN <ul style="list-style-type: none"> – Press [Enter] to remove an existing VLAN.

5-2-15 MAC IPv6 Network Configuration

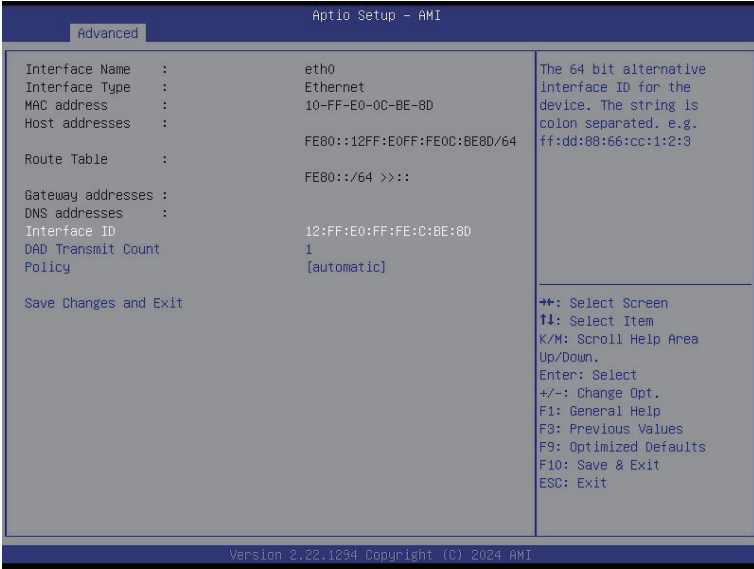

Parameter	Description
Enter Configuration Menu	<p>Press [Enter] to configure advanced items.</p> <ul style="list-style-type: none"> ◆ Displays the MAC Address information. ◆ Interface ID <ul style="list-style-type: none"> – The 64 bit alternative interface ID for the device. The string is colon separated. e.g. ff:dd:88:66:cc:1:2:3. ◆ DAD Transmit Count <ul style="list-style-type: none"> – The number of consecutive Neighbor solicitation messages sent while performing Duplicate Address Detection on a tentative address. A value of zero indicates that Duplicate Address Detection is not performed. ◆ Policy <ul style="list-style-type: none"> – Options available: automatic, manual. Default setting is automatic. ◆ Save Changes and Exit <ul style="list-style-type: none"> – Press [Enter] to save all configurations.

5-2-16 MAC IPv4 Network Configuration

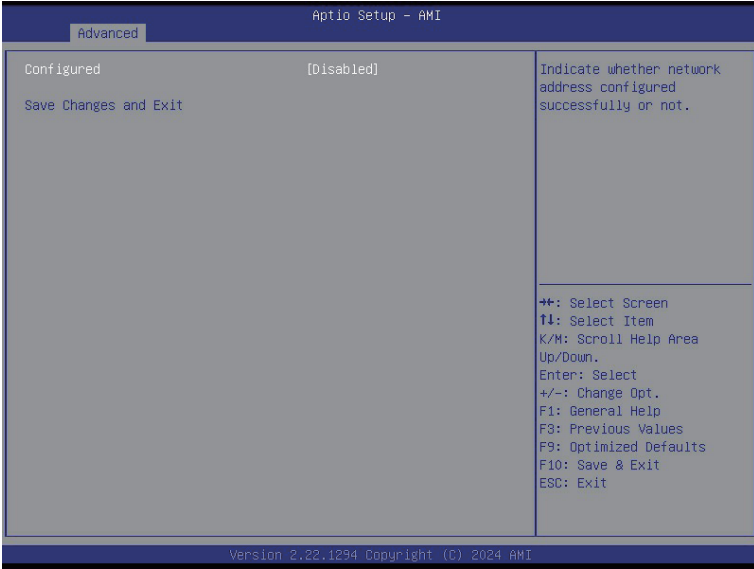

Parameter	Description
Configured ^(Note)	Indicates whether network address is configured successfully or not. Options available: Enabled, Disabled. Default setting is Disabled .
Enable DHCP	Options available: Enabled, Disabled. Default setting is Disabled .
Local IP Address	Press [Enter] to configure local IP address.
Local NetMask	Press [Enter] to configure local NetMask.
Local Gateway	Press [Enter] to configure local Gateway
Local DNS Servers	Press [Enter] to configure local DNS servers
Save Changes and Exit	Press [Enter] to save all configurations.

(Note) This item appears when **Configured** is set to **Enabled**.

5-2-17 Driver Health



Parameter	Description
Driver Health	Displays driver health status of the devices/controllers if installed

5-3 Chipset Menu

The Chipset Setup menu displays submenu options for configuring the chipset functions. Select a submenu item, then press <Enter> to access the related submenu screen.

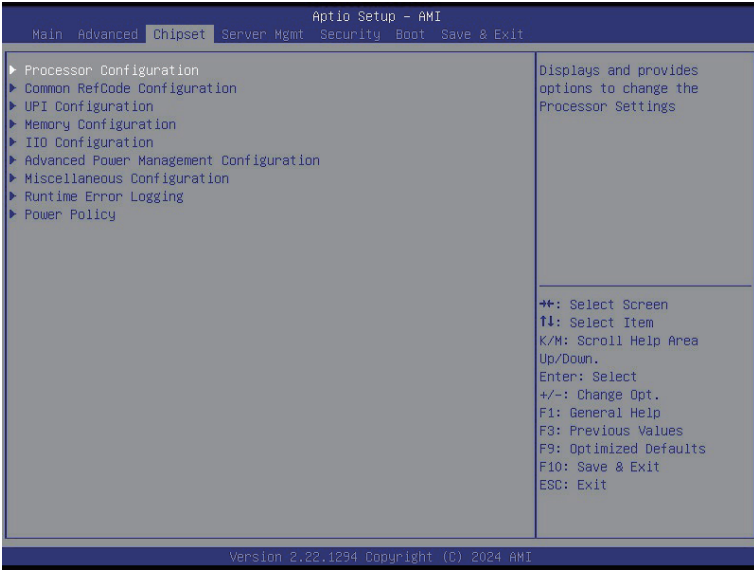

5-3-1 Processor Configuration

Aptio Setup - AMI

Chipset

Processor Configuration		Change Per-Socket Settings

▶ Per-Socket Configuration		
Processor Socket	Socket 0	
Processor ID	000A06D0*	N/A
Processor Frequency	2.000GHz	N/A
Processor Max Ratio	14H	N/A
Processor Min Ratio	08H	N/A
Microcode Revision	80000640	N/A
L1 Cache RAM(Per Core)	112KB	N/A
L2 Cache RAM(Per Core)	2048KB	N/A
L3 Cache RAM(Per Package)	516096KB	N/A
Processor 0 Version	GENUINE INTEL(R) XEON(R))	
Enable LP [Global]	[ALL LPs]	
Hardware Prefetcher	[Enable]	
Adjacent Cache Prefetch	[Enable]	
DCU Streamer Prefetcher	[Auto]	
DCU IP Prefetcher	[Enable]	
LLC Prefetch	[Disable]	
Homeless Prefetch	[Auto]	
FB Thread Slicing	[Disable]	
AMP Prefetch	[Enable]	
Enable Intel(R) TXT	[Disable]	

		++: Select Screen ↑↓: Select Item K/M: Scroll Help Area Up/Down. Enter: Select +/-: Change Opt. F1: General Help F8: Previous Values F9: Optimized Defaults F10: Save & Exit ESC: Exit
Version 2.22.1294 Copyright (C) 2024 AMI		

Aptio Setup - AMI

Chipset

Processor Reserved Memory [Outputs]		In Field Scan (IFS)

PMRMR Size per domain	16 MiB	
PRM Size per socket	16 MiB	
PRM Size per system	16 MiB	

Software Guard Extension (SGX) [Outputs]		

SGX activation state	Deactivated	
SGX memory population for SGX enabling is not POR. Please check your memory population.		
SGX error code [HEX]	16	

Software Guard Extension (SGX) [Inputs]		

SGX Factory Reset	[Disabled]	
SW Guard Extensions (SGX)	[Disabled]	
SGX Package Info In-Band Access	[Disabled]	
SGX PMRMR Size Requested	[Auto]	

In Field Scan (IFS)		

▶ In Field Scan (IFS)		

		++: Select Screen ↑↓: Select Item K/M: Scroll Help Area Up/Down. Enter: Select +/-: Change Opt. F1: General Help F8: Previous Values F9: Optimized Defaults F10: Save & Exit ESC: Exit
Version 2.22.1294 Copyright (C) 2024 AMI		

Parameter	Description
Processor Configuration	
Pre-Socket Configuration	<p>Press [Enter] to configure advanced items.</p> <ul style="list-style-type: none"> ◆ CPU Socket 0/1 Configuration <ul style="list-style-type: none"> – Core Disable Bitmap(Hex) <ul style="list-style-type: none"> • Number of Cores to enable. 0 means all cores. FFFFFFFF means to disable all cores. The maximum value depends on the number of CPUs available. Press the numeric keys to adjust desired values.
Processor Socket / Processor ID / Processor Frequency / Processor Max Ratio / Processor Min Ratio / Microcode Revision / L1 Cache RAM(Per Core) / L2 Cache RAM(Package) / L3 Cache RAM(Per Package) / Processor # Version	Displays the technical specifications for the installed processor(s).
Hardware Prefetcher	Select whether to enable the speculative prefetch unit of the processor. Options available: Enable, Disable. Default setting is Enable .
L2 RF0 Prefetch Disable	Options available: Enable, Disable. Default setting is Disable .
Adjacent Cache Prefetch	When enabled, cache lines are fetched in pairs. When disabled, only the required cache line is fetched. Options available: Enable, Disable. Default setting is Enable .
DCU Streamer Prefetcher	Enable/Disable DCU streamer prefetcher. Options available: Enable, Disable. Default setting is Enable .
DCU IP Prefetcher	Enable/Disable DCU IP Prefetcher. Options available: Enable, Disable. Default setting is Enable .
Enable Intel(R) TXT	Enable/Disable the Intel Trusted Execution Technology support function. Options available: Enable, Disable. Default setting is Disable .
VMX	Enable/Disable the Vanderpool Technology. This will take effect after rebooting the system. Options available: Enable, Disable. Default setting is Enable .
Enable SMX	Enable/Disable the Safer Mode Extensions (SMX) support function. Options available: Enable, Disable. Default setting is Disable .
AES-NI	Enable/Disable the AES-NI support. Options available: Enable, Disable. Default setting is Enable .
Debug Consent	Options available: Enable, Disable. Default setting is Disable .

Parameter	Description
Memory Encryption (TME) ^(Note)	Enable/Disable memory encryption (TME). Options available: Enabled, Disabled. Default setting is Disabled .
Total Memory Encryption Multi-Tenant (TME-MT)	Options available: Enabled, Disabled. Default setting is Disabled .
Memory integrity	Options available: Enabled, Disabled. Default setting is Disabled .
Trust Domain Extension (TDX)	Options available: Enabled, Disabled. Default setting is Disabled .
SGX error code [HEX]	Shows hexadecimal SGX internal error code.
SGXx Factory Reset	Perform SGX Factory Reset, on subsequent boot: delete all registration data, if SGX enabled will force Initial Platform Establishment flow. Options available: Enabled, Disabled. Default setting is Disabled .
SW Guard Extension (SGX)	Options available: Enabled, Disabled. Default setting is Disabled .
SGX Package Inf In-Band Access	Options available: Enabled, Disabled. Default setting is Disabled .
SGX PRMRR Size Requested	Options available: Enabled, Disabled. Default setting is Auto .
In-Field Scan (IFS)	Press [Enter] to configure advanced items. <ul style="list-style-type: none"> ◆ Enable SAF <ul style="list-style-type: none"> – Options available: Disabled, Enabled. – Default setting is Disabled. ◆ SAF PRMRR Size Requested <ul style="list-style-type: none"> – Default setting is 8M.

(Note) Advanced items prompt when this item is defined.

5-3-2 Common RefCode Configuration

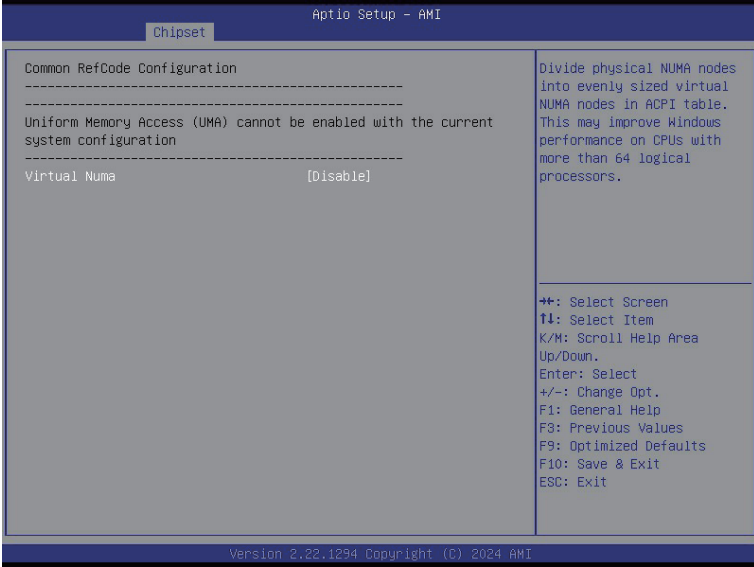

Parameter	Description
Common RefCode Configuration	
Virtual Numa ^(note)	Divide physical NUMA nodes into evenly sized virtual NUMA nodes in ACPI table. This may improve Windows performance on CPUs with more than 64 logical processors. Options available: Enable, Disable. Default setting is Disable .
Number of Virtual Numa Nodes	The number of virtual NUMA nodes per physical NUMA nodes. 0 means automatically set the number of virtual NUMA nodes baes on system configuration. 1 equals disabling virtual NUMA.

(Note) Advanced items prompt when this item is defined.

5-3-3 UPI Configuration

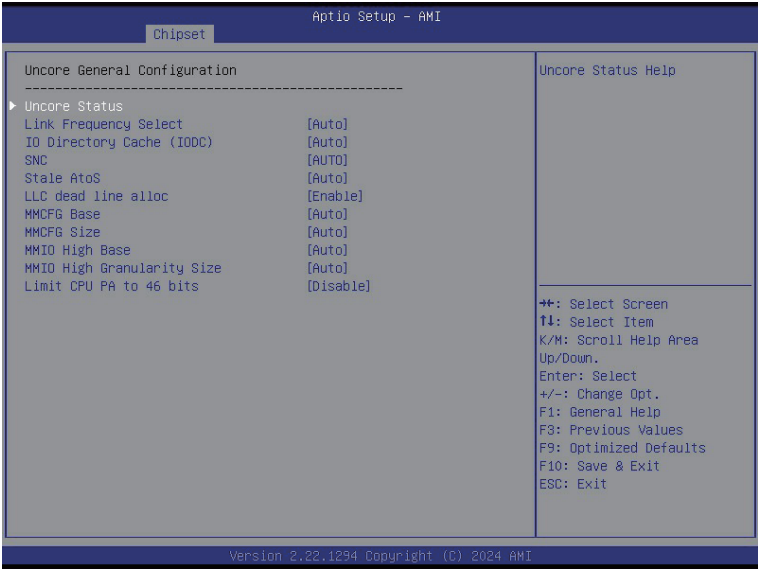

Parameter	Description
UPI General Configuration	<p data-bbox="348 142 682 166">Press [Enter] to configure advanced items.</p> <ul style="list-style-type: none"> <li data-bbox="348 170 719 224">◆ Uncore Status <ul style="list-style-type: none"> <li data-bbox="384 200 719 224">– Press [Enter] to view the Uncore status. <li data-bbox="348 228 650 341">◆ Link Frequency Select <ul style="list-style-type: none"> <li data-bbox="384 258 650 282">– Selects the UPI link frequency. <li data-bbox="384 286 956 341">– Options available: 12.8GT/s, 14.4GT/s, 16.0GT/s, Auto, Use Per Link Setting. Default setting is Auto. <li data-bbox="348 346 935 459">◆ SNC <ul style="list-style-type: none"> <li data-bbox="384 376 753 399">– Enable/Disable Sub NUMA Cluster function. <li data-bbox="384 404 935 459">– Options available: Auto, Disable, Enable SNC2 (2-clusters), Enable SNC4 (4-clusters). Default setting is Auto. <li data-bbox="348 464 913 548">◆ Stale AtoS <ul style="list-style-type: none"> <li data-bbox="384 493 801 517">– Enable/Disable Stale A to S directory optimization. <li data-bbox="384 522 913 548">– Options available: Disable, Enable, Auto. Default setting is Auto. <li data-bbox="348 553 932 638">◆ LLC dead line alloc <ul style="list-style-type: none"> <li data-bbox="384 583 695 606">– Enable/Disable fill dead lines in LLC. <li data-bbox="384 611 932 638">– Options available: Disable, Enable, Auto. Default setting is Enable. <li data-bbox="348 642 859 727">◆ MMCFG Base <ul style="list-style-type: none"> <li data-bbox="384 672 859 696">– Options available: 1G, 1.5G, 1.75G, 2G, 2.25G, 3G, Auto. <li data-bbox="384 700 591 727">– Default setting is Auto. <li data-bbox="348 732 873 816">◆ MMCFG Size <ul style="list-style-type: none"> <li data-bbox="384 762 873 785">– Options available: 64M, 128M, 256M, 512M, 1G, 2G, Auto . <li data-bbox="384 790 591 816">– Default setting is Auto. <li data-bbox="348 821 956 906">◆ MMIO High Base <ul style="list-style-type: none"> <li data-bbox="384 851 956 906">– Options available: 56T, 40T, 32T, 24T, 16T, 4T, 2T, 1T, 512G, 3584T. Default setting is Auto. <li data-bbox="348 911 876 1014">◆ MMIO High Granularity Size <ul style="list-style-type: none"> <li data-bbox="384 939 876 962">– Selects the allocation size used to assign mmioh resources. <li data-bbox="384 967 956 1014">– Options available: 1G, 4G, 16G, 64G, 256G, 1024G. Default setting is 64G. <li data-bbox="348 1019 937 1072">◆ Limit CPU PA to 46 bits <ul style="list-style-type: none"> <li data-bbox="384 1048 937 1072">– Options available: Disable, Enable, Auto. Default setting is Disable. <li data-bbox="348 1077 727 1161">◆ Reduce LLC Age-Bit Default <ul style="list-style-type: none"> <li data-bbox="384 1107 727 1130">– Options available: Disable, Enable, Auto. <li data-bbox="384 1135 701 1161">– Enable, Auto. Default setting is Auto.

5-3-4 Memory Configuration

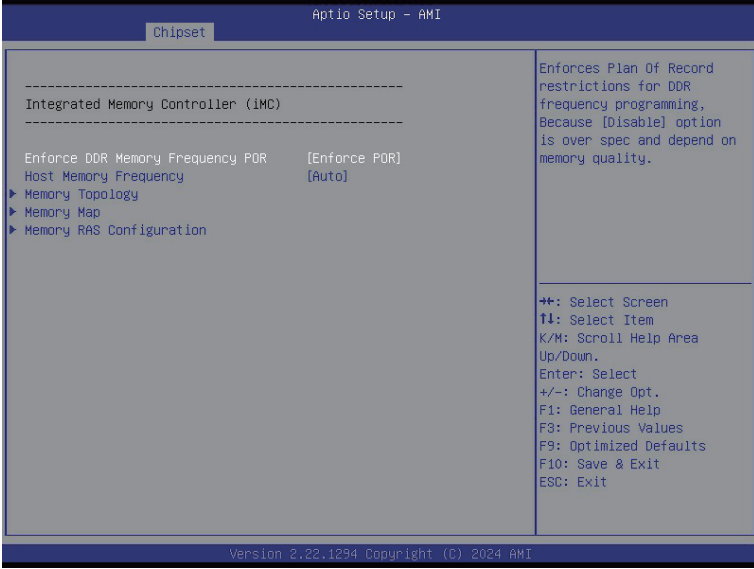

Parameter	Description
Integrated Memory Controller (iMC)	
Enforce DDR Memory Frequency POR	When set to Enable, the system enforces Plan Of Record restrictions for DDR frequency programming. Options available: POR, Disable. Default setting is POR .
Host Memory Frequency	Maximum Host DDR Memory Frequency Selections in MT/s. If the AUTO option has been selected, a frequency is chosen automatically based on the minimum tCK given by the SPD. Options available: Auto, 4800, 5200, 5600, 6000, 6400. Default setting is Auto .

Parameter	Description
Memory Topology	Press [Enter] to view memory topology with DIMM population information.
Memory Map	<p>Press [Enter] to configure advanced items.</p> <ul style="list-style-type: none"> ◆ Intel(R) Flat Memory Mode Support. <ul style="list-style-type: none"> – Options available: Enabled, Disabled. Default setting is Disabled. ◆ DDR CXL Heterogeneous Interleave support. <ul style="list-style-type: none"> – Options available: Enabled, Disabled. Default setting is Disabled.
Memory RAS Configuration	<p>Press [Enter] to configure advanced items.</p> <ul style="list-style-type: none"> ◆ Mirror Mode^(Note) <ul style="list-style-type: none"> – Mirror Mode will set entire 1LM memory in system to be mirrored, consequently reducing the memory capacity by half. Enables the Mirror Mode will disable the XPT Prefetch. – Options available: Disabled, Full Mirror Mode, Partial Mirror Mode. Default setting is Disabled. ◆ Correctable Error Threshold <ul style="list-style-type: none"> – Correctable Error Threshold (0x01-0x7fff) used for sparing, and leaky bucket. – Press the <+> / <-> keys to increase or decrease the desired values. ◆ Leaky bucket time window based interface <ul style="list-style-type: none"> – Enable/Disable leaky bucket time window based interface. – Options available: Disabled, Enabled. Default setting is Disabled. ◆ Leaky bucket low bit <ul style="list-style-type: none"> – Configures leaky bucket low bit (0x1 - 0x29). – Press the <+> / <-> keys to increase or decrease the desired values. ◆ Leaky bucket high bit <ul style="list-style-type: none"> – Configures leaky bucket high bit (0x1 - 0x29). – Press the <+> / <-> keys to increase or decrease the desired values.

(Note) Advanced items prompt when this item is defined.

Parameter	Description
Memory RAS Configuration (continued)	<ul style="list-style-type: none"> ◆ ADDDC Sparing^(Note) <ul style="list-style-type: none"> – Enable/Disable ADDDC Sparing. – Options available: Disabled, Enabled. Default setting is Disabled. ◆ Enable ADDDC Error Injection <ul style="list-style-type: none"> – Options available: Disabled, Enabled. Default setting is Enabled. ◆ Patrol Scrub <ul style="list-style-type: none"> – Options available: Disabled, Enable at End of POST. Default setting is Enable at End of POST. ◆ Patrol Scrub Interval <ul style="list-style-type: none"> – Selects the number of hours (1-24) required to complete full scrub. A value of zero means auto. ◆ DDR5 ECS <ul style="list-style-type: none"> – Options available: Disabled, Enabled, Enable ECS with Result Collection. Default setting is Enabled.

(Note) Advanced items prompt when this item is defined.

5-3-5 IIO Configuration

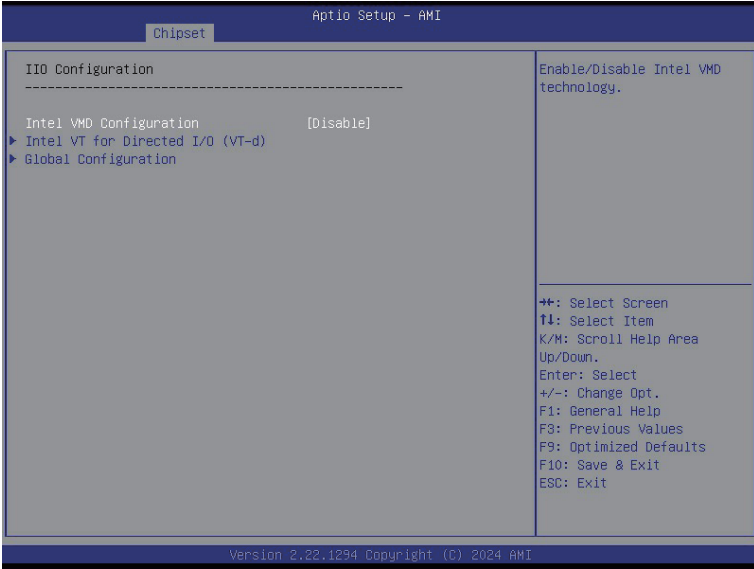

Parameter	Description
IIO Configuration	
Intel VMD Configuration	Enable/Disable Intel VMD technology. Options available: Enable, Disable. Default setting is Disable .
Intel VT for Directed I/O (VT-d)	Press [Enter] to configure advanced items. <ul style="list-style-type: none"> ◆ DMA Control Opt-In Flag <ul style="list-style-type: none"> – Enable/Disable DMA_CTRL_PLATFORM_OPT_IN_FLAG in DMAR table in ACPI. Not compatible with Direct Device Assignment (DDA). ◆ Pre-boot DMA Protection <ul style="list-style-type: none"> – Options available: Enable, Disable. Default setting is Disable. ◆ PCIe ACSCTL <ul style="list-style-type: none"> – Options available: Enable, Disable. Default setting is Disable. ◆ Cache Allocation <ul style="list-style-type: none"> – Options available: Enable, Disable. Default setting is Enable.
Global Configuration	Press [Enter] to configure advanced items. <ul style="list-style-type: none"> ◆ Max Read Request Size <ul style="list-style-type: none"> – Options available: Auto, 128B, 256B, 512B, 1024B, 2048B, 4096B. Default setting is Auto. ◆ Relaxed Ordering <ul style="list-style-type: none"> – Options available: Enable, Disable. Default setting is Enable.

5-3-6 Advanced Power Management Configuration

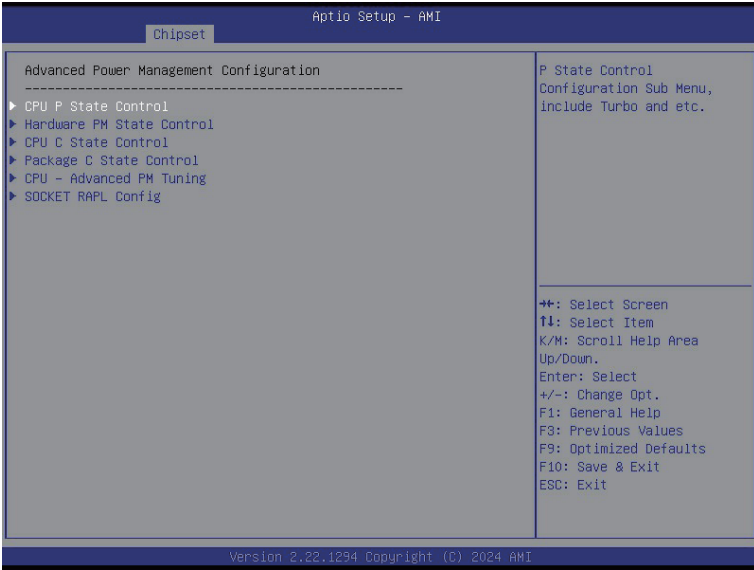

Parameter	Description
CPU P State Control	<p>Press [Enter] to configure advanced items.</p> <ul style="list-style-type: none"> ◆ Intel SST-PP <ul style="list-style-type: none"> – Intel SST-PP Select allows user to choose level. – Options available: Auto, Level 0, Level 1. Default setting is Auto. ◆ SpeedStep (Pstates) <ul style="list-style-type: none"> – Conventional Intel SpeedStep Technology switches both voltage and frequency in tandem between high and low levels in response to processor load. – Options available: Enable, Disable. Default setting is Enable. ◆ Turbo Mode <ul style="list-style-type: none"> – When this item is enabled, the processor will automatically ramp up the clock speed of 1-2 of its processing cores to improve its performance. When this item is disabled, the processor will not overclock any of its core. – Options available: Enable, Disable. Default setting is Enable.

Parameter	Description
Hardware PM State Control	<p>Press [Enter] to configure advanced items.</p> <ul style="list-style-type: none"> ◆ Hardware P-States <ul style="list-style-type: none"> – When this item is disabled, the processor hardware chooses a P-state based on OS Request (Legacy P-States). – In Native mode, the processor hardware chooses a P-state based on OS guidance. – In Out of Band mode, the processor hardware autonomously chooses a P-state (with no OS guidance). – Options available: Disable, Native Mode, Out of Band Mode, Native Mode with No Legacy Support. Default setting is Native Mode. ◆ Hardware PM Interrupt <ul style="list-style-type: none"> – Enable/Disable Hardware PM Interrupt. – Options available: Disable, Enable. Default setting is Disable. ◆ Native ASPM <ul style="list-style-type: none"> – Enable: OS controlled ASPM. – Disable: ASPM off. – Auto: BIOS controlled ASPM. – Options available: Auto, Disable, Enable. Default setting is Auto.
CPU C State Control	<p>Press [Enter] to configure advanced items.</p> <ul style="list-style-type: none"> ◆ Monitor MWAIT <ul style="list-style-type: none"> – Options available: Disable, Enable. Default setting is Enable. ◆ ACPI C1 Enumeration <ul style="list-style-type: none"> – Options available: C1, C1e . Default setting is C1e. ◆ ACPI C6x Enumeration <ul style="list-style-type: none"> – Options available: Dsiable, C6S as ACPI C2, C6S as ACPI C3, C6S-P as ACPI C2, C6S-P as ACPI C3, Auto . – Default setting is Auto.
Package C State Control	<p>Press [Enter] to configure advanced items.</p> <ul style="list-style-type: none"> ◆ Package C State <ul style="list-style-type: none"> – Configures the state for the C-State package limit. – Options available: C0/C1 state, C2 state, C6(non Retention) state, C6(Retention) state, No Limit, Auto. Default setting is Auto.
CPU - Advanced PM Tuning	<p>Press [Enter] to configure advanced items.</p> <ul style="list-style-type: none"> ◆ Energy Perf BIAS <ul style="list-style-type: none"> – Press [Enter] to configure advanced items. <ul style="list-style-type: none"> » Power Performance Tuning <ul style="list-style-type: none"> • Options available: OS Controls EPB, BIOS Controls EPB, PECl Controls EPB. Default setting is OS Controls EPB. » Energy_PERF_BIAS_CFG mode^(Note) <ul style="list-style-type: none"> • Options available: Performance, Balanced Performance, Balanced Power, Power. Default setting is Balanced Performance.

SOCKET RAPL Config

Press [Enter] to configure advanced items.

- ◆ PL1 Power Limit
 - Press the <+> / <-> keys to increase or decrease the desired values.
- ◆ PL1 Time Window
 - Default setting is 1.
- ◆ PL2 Power Limit
 - Press the <+> / <-> keys to increase or decrease the desired values.
- ◆ PL2 Time Window
 - Default setting is 1.

5-3-7 Miscellaneous Configuration

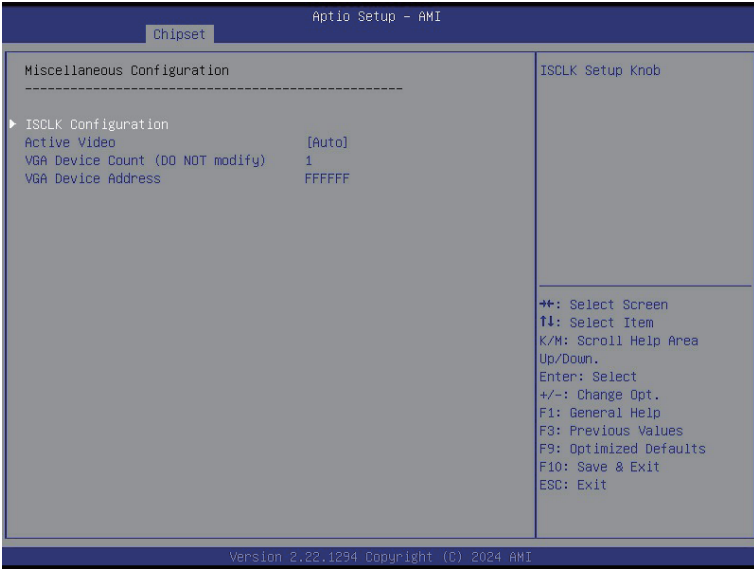

Parameter	Description
Miscellaneous Configuration	
ISCLK Configuration	Press [Enter] to configure advanced items. <ul style="list-style-type: none"> - SSC1 Enable - Options available: Enable, Disable. Default setting is Enable. - SSC2 Enable - Options available: Enable, Disable. Default setting is Enable.
Active Video	Selects the active video type. Options available: Auto, Onboard Device, PCIE Device, Specific PCIE Device. Default setting is Auto .
VGA Device Count (NOT modify)	
VGA Device Address	VGA Device Address

5-3-8 Runtime Error Logging Settings

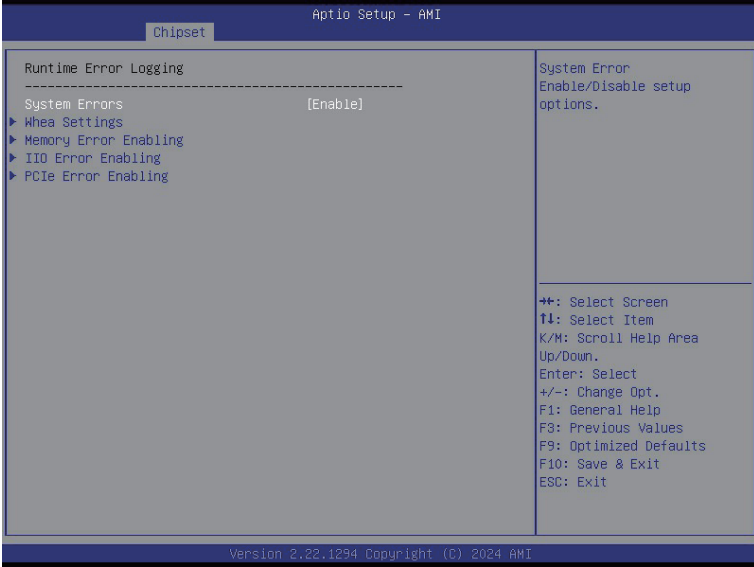

Parameter	Description
Runtime Error Logging	
System Errors	Enable/Disable system error logging function. Options available: Enable, Disable. Default setting is Enable .
Whea Settings	Press [Enter] to configure advanced items. <ul style="list-style-type: none"> ◆ WHEA (Windows Hardware Error Architecture) Support <ul style="list-style-type: none"> – Enable/Disable WHEA Support. – Options available: Enable, Disable. Default setting is Enable.
Memory Error Enabling	Press [Enter] to configure advanced items. <ul style="list-style-type: none"> ◆ Memory Corrected Error <ul style="list-style-type: none"> – Enable/Disable Memory Corrected Error. – Options available: Enable, Disable. Default setting is Enable. ◆ Uncorrected Error disable Memory <ul style="list-style-type: none"> – Enable/Disable the Memory that triggers Uncorrected Error. – Options available: Enable, Disable. Default setting is Disable.
IIO Error Enabling	Press [Enter] to configure advanced items. <ul style="list-style-type: none"> ◆ OS Native AER Support <ul style="list-style-type: none"> – Select FFM or OS native for AER error handling. If select OS native, BIOS also initialize FFM first until handshake, which depends on OS capability. – Options available: Enable, Disable. Default setting is Disable.

Parameter	Description
PCIe Error Enabling	<p data-bbox="309 142 642 166">Press [Enter] to configure advanced items.</p> <ul style="list-style-type: none"> <li data-bbox="309 174 852 252">◆ Corrected Error <ul style="list-style-type: none"> <li data-bbox="344 200 795 224">– Enables and escalates correctable Errors to error pins. <li data-bbox="344 232 852 252">– Options available: Enable, Disable. Default setting is Disable. <li data-bbox="309 260 923 338">◆ Uncorrected Error <ul style="list-style-type: none"> <li data-bbox="344 286 923 310">– Enables and escalates Uncorrectable/Recoverable Errors to error pins. <li data-bbox="344 318 846 338">– Options available: Enable, Disable. Default setting is Enable. <li data-bbox="309 346 846 424">◆ Fatal Error Enable <ul style="list-style-type: none"> <li data-bbox="344 373 749 396">– Enables and escalates Fatal Errors to error pins. <li data-bbox="344 404 846 424">– Options available: Enable, Disable. Default setting is Enable. <li data-bbox="309 432 940 542">◆ Assert NMI on SERR <ul style="list-style-type: none"> <li data-bbox="344 459 940 514">– Enable/Disable BIOS generates a non-maskable interrupt (NMI) and logs an error when a system error (SERR) occurs. <li data-bbox="344 522 876 542">– Options available: Enabled, Disabled. Default setting is Enabled. <li data-bbox="309 550 940 660">◆ Assert NMI on PERR <ul style="list-style-type: none"> <li data-bbox="344 577 940 631">– Enable/Disable BIOS generates a non-maskable interrupt (NMI) and logs an error when a processor bus parity error (PERR) occurs. <li data-bbox="344 639 876 660">– Options available: Enabled, Disabled. Default setting is Enabled.

5-3-9 Power Policy

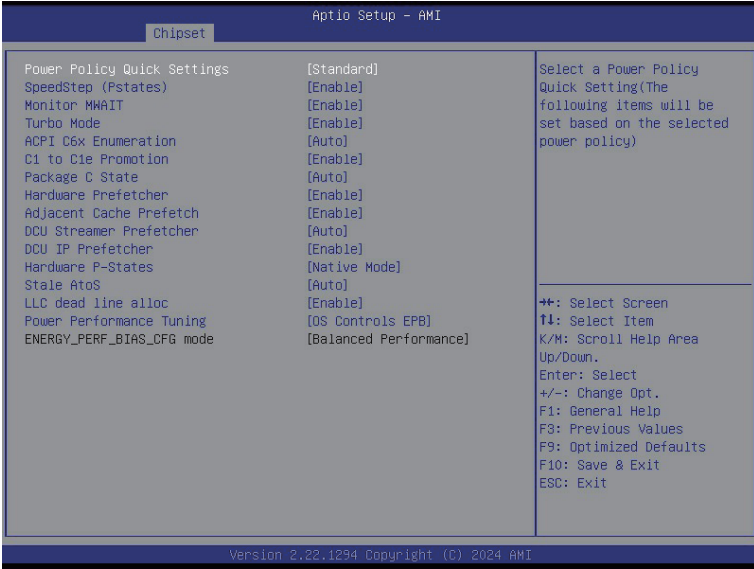

Parameter	Description
Power Policy Quick Settings	Selects a Power Policy Quick Setting. Options available: Standard, Best Performance, Energy Efficient. Default setting is Standard .
SpeedStep (Pstates)	Conventional Intel SpeedStep Technology switches both voltage and frequency in tandem between high and low levels in response to processor load. Options available: Enable, Disable. Default setting is Enable .
Monitor MWAIT	Allows Monitor and MWAIT instructions. Options available: Enable, Disable. Default setting is Enable .
Turbo Mode	When this item is enabled, the processor will automatically ramp up the clock speed of 1-2 of its processing cores to improve its performance. When this item is disabled, the processor will not overclock any of its core. Options available: Enable, Disable. Default setting is Enable .
ACPI C6x Enumeration	Options available: Disable, C6S as ACPI C2, C6S as ACPI C3, C6S-P as ACPI C2, C6S-P as ACPI C3, Auto. Default setting is Auto .
ACPI C1 Enumeration	Options available: C1, C1e. Default setting is C1e .
Package C State	Configures the C-State package limit. Options available: C0/C1 state, C2 state, C6(non Retention) state, C6(Retention) state, No Limit, Auto. Default setting is Auto .

Parameter	Description
Hardware Prefetcher	Options available: Enable, Disable. Default setting is Enable .
Adjacent Cache Prefetch	Options available: Enable, Disable. Default setting is Enable .
DCU Streamer Prefetcher	Options available: Enable, Disable. Default setting is Enable .
L1 Next page Prefetcher	Options available: Enable, Disable. Default setting is Enable .
Hardware P-States	Options available: Disable, Native mode, Out of Band mode, Native Mode with No Legacy Support. Default setting is Native Mode .
Stale AtoS	Options available: Auto, Enable, Disable. Default setting is Auto .
LLC dead line alloc	Options available: Auto, Enable, Disable. Default setting is Enable .
Power Performance Tuning	Options available: OS Controls EPB, BIOS Controls EPB, PECC Controls EPB. Default setting is BIOS Controls EPB .
ENERGY_PERF_BIAS_CFG mode	Performance, Balanced Performance, Balanced Power, Power. Default setting is Balanced Performance .

5-4 Server Management Menu

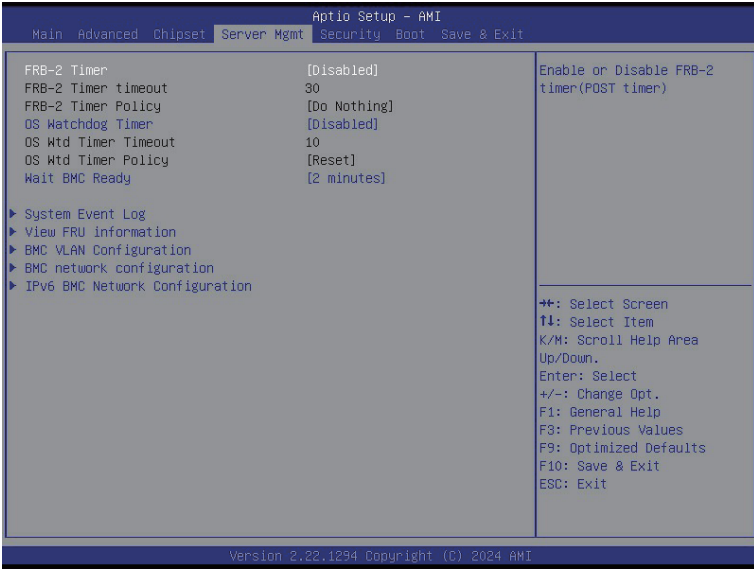

Parameter	Description
FRB-2 Timer	Enable/Disable FRB-2 timer (POST timer). Options available: Enabled, Disabled. Default setting is Enabled .
FRB-2 Timer ^(Note1) timeout	Configures the FRB2 Timer timeout. The value is between 1 to 30 minutes. Default setting is 6 minutes .
FRB-2 Timer Policy ^(Note1)	Configures the FRB2 Timer policy. Options available: Do Nothing, Reset, Power Down, Power Cycle. Default setting is Do Nothing .
OS Watchdog Timer	Enable/Disable OS Watchdog Timer function. Options available: Enabled, Disabled. Default setting is Disabled .
OS Wtd Timer Timeout ^(Note2)	Configures OS Watchdog Timer. The value is between 1 to 30 minutes. Default setting is 10 minutes .
OS Wtd Timer Policy ^(Note2)	Configure OS Watchdog Timer Policy. Options available: Reset, Do Nothing, Power Down, Power Cycle. Default setting is Reset .
Wait BMC Ready	POST wait BMC ready and reboot system. Options available: Disabled, 2 minutes, 4 minutes, 6 minutes. Default setting is 2 minutes .

(Note1) This item is configurable when **FRB-2 Timer** is set to **Enabled**.

(Note2) This item is configurable when **OS Watchdog Timer** is set to **Enabled**.

Parameter	Description
System Event Log	Press [Enter] to configure advanced items.
View FRU Information	Press [Enter] to view the FRU information.
BMC VLAN Configuration	Press [Enter] to configure advanced items.
BMC network Configuration	Press [Enter] to configure advanced items.
IPv6 BMC Network Configuration	Press [Enter] to configure advanced items.

5-4-1 System Event Log

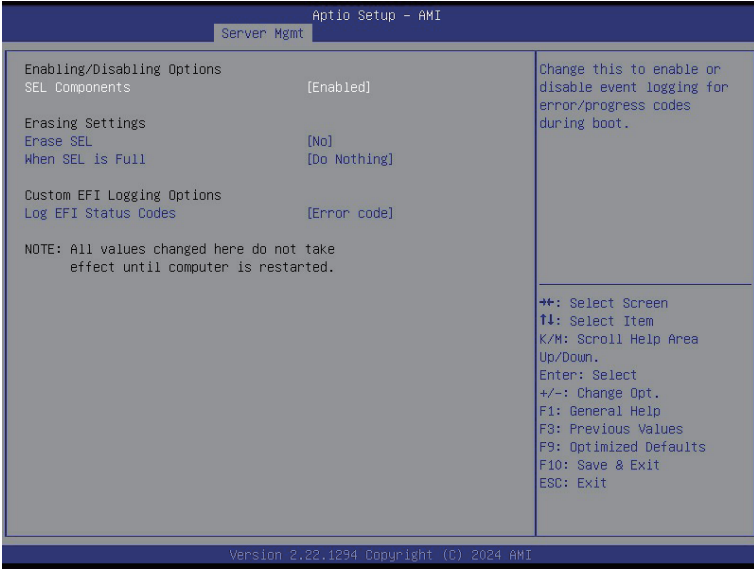

Parameter	Description
Enabling / Disabling Options	
SEL Components	Change this item to enable or disable all features of System Event Logging during boot. Options available: Enabled, Disabled. Default setting is Enabled .
Erasing Settings	
Erase SEL	Choose options for erasing SEL. Options available: No, Yes, On next reset, Yes, On every reset. Default setting is No .
When SEL is Full	Choose options for reactions to a full SEL. Options available: Do Nothing, Erase Immediately, Delete Oldest Record. Default setting is Do Nothing .
Custom EFI Logging Options	
Log EFI Status Codes	Enable/Disable the logging of EFI Status Codes (if not already converted to legacy). Options available: Disabled, Both, Error code, Progress code. Default setting is Error code .

5-4-2 View FRU Information

The FRU page is a simple display page for basic system ID information, as well as System product information. Items on this window are non-configurable.

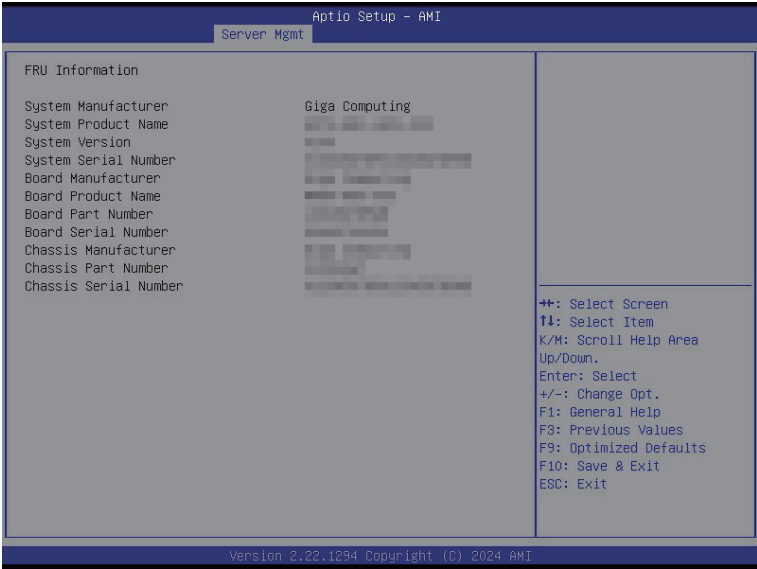

(Note) The model name will vary depends on the product you purchased

5-4-3 BMC VLAN Configuration

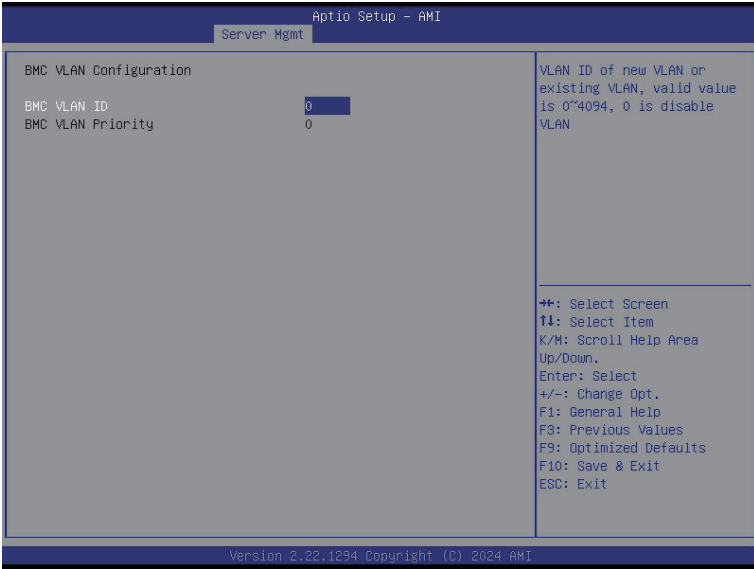

Parameter	Description
BMC VLAN Configuration	
BMC VLAN ID	Select to configure BMC VLAN ID. The valid range is from 0 to 4094. When set to 0, BMC VLAN ID will be disabled.
BMC VLAN Priority	Select to configure BMC VLAN Priority. The valid range is from 0 to 7. When BMC VLAN ID is set to 0, BMC VLAN Priority will not be selected.

5-4-4 BMC Network Configuration

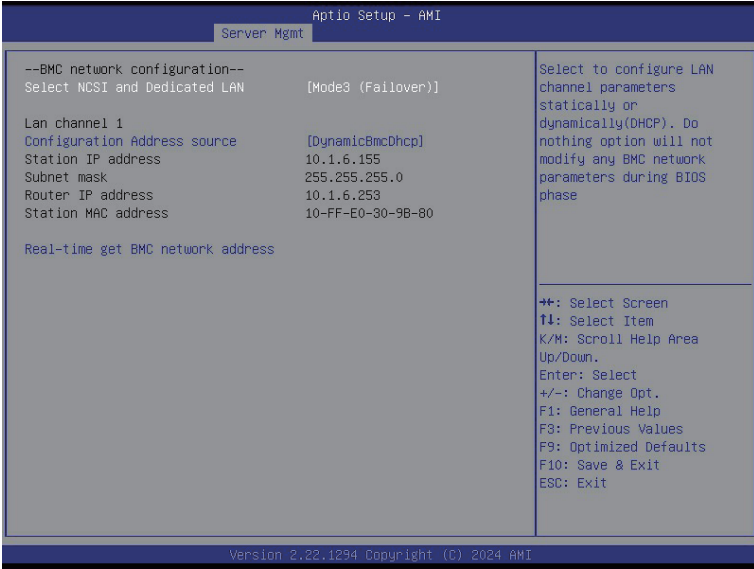

Parameter	Description
BMC network configuration	
Select NCSI and Dedicated LAN	Options available: Do Nothing, Model1(Dedicated), Model2(NCSI), Mode3(Failover). Default setting is Do Nothing .
Lan Channel 1	
Configuration Address source	Selects to configure LAN channel parameters statically or dynamically (DHCP). Options available: Unspecified, Static, DynamicBmcDhcp. Default setting is DynamicBmcDhcp .
Station IP address	Displays IP Address information.
Subnet mask	Displays Subnet Mask information. Please note that the IP address must be in three digitals, for example, 192.168.000.001.
Router IP address	Displays the Router IP Address information.
Station MAC address	Displays the MAC Address information.
Real-time get BMC network address	Press [Enter] will set LAN mode and Address source and then get IP, Subnet, Gateway and MAC address.

5-4-5 IPv6 BMC Network Configuration

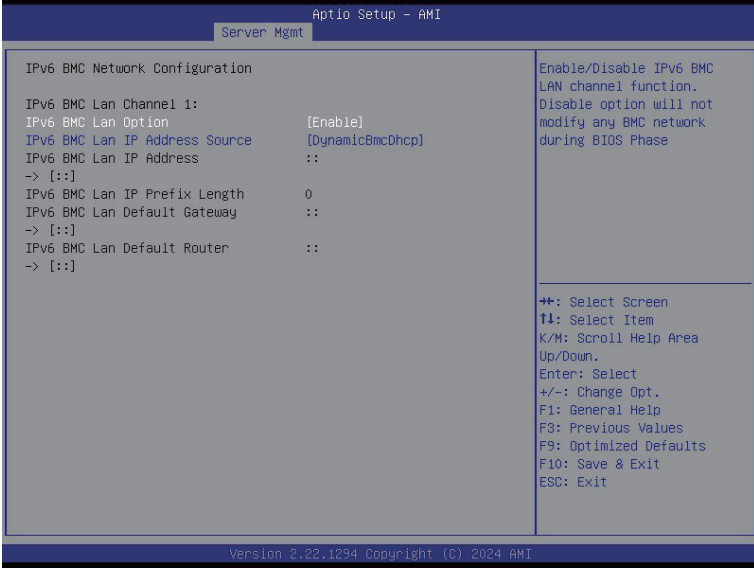

Parameter	Description
IPv6 BMC network configuration	
IPv6 BMC Lan Channel 1	
IPv6 BMC Lan Option	Enable/Disable IPv6 BMC LAN channel function. When this item is disabled, the system will not modify any BMC network during BIOS phase. Options available: Unspecified, Disable, Enable. Default setting is Enable .
IPv6 BMC Lan IP Address Source	Selects to configure LAN channel parameters statically or dynamically (by BIOS or BMC). Options available: Unspecified, Static, Dynamic-Obtained by BMC running DHCP. Default setting is Dynamic-Obtained by BMC running DHCP .
IPv6 BMC Lan IP Address/Prefix Length	Check if the IPv6 BMC LAN IP address matches those displayed on the screen.

5-5 Security Menu

The Security menu allows you to safeguard and protect the system from unauthorized use by setting up access passwords.

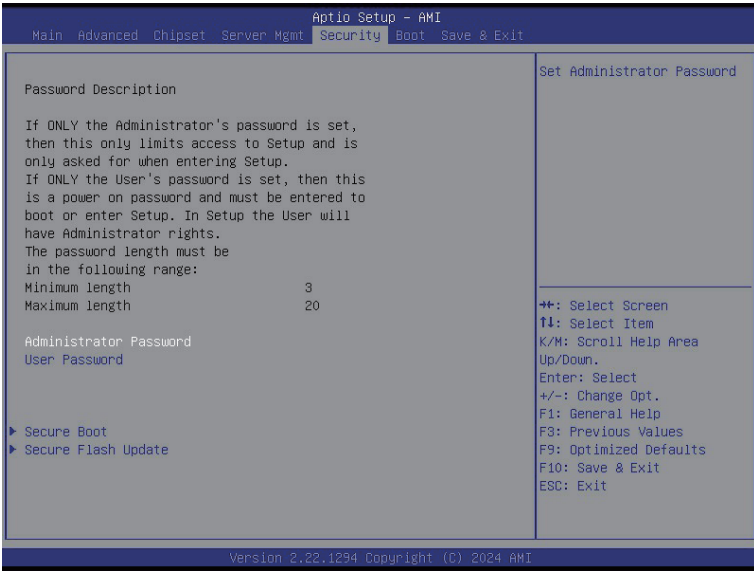

There are two types of passwords that you can set:

- **Administrator Password**
Entering this password will allow the user to access and change all settings in the Setup Utility.
- **User Password**
Entering this password will restrict a user's access to the Setup menus. To enable or disable this field, a Administrator Password must first be set. A user can only access and modify the System Time, System Date, and Set User Password fields.

Parameter	Description
Administrator Password	Press [Enter] to configure the administrator password.
User Password	Press [Enter] to configure the user password.
Media Ssanitization	Press [Enter] to configure advanced items.
Secure Boot	Press [Enter] to configure advanced items.
Secure Flash Update	Press [Enter] to view advanced items.

5-5-1 Secure Boot

The Secure Boot feature is applicable if supported by your Operating System.

If your Operating System is not supporting Secure Boot, the system will hang when starting the Operating System.



Parameter	Description
System Mode	Displays if the system is in User mode or Setup mode.
Secure Boot	Enable/ Disable the Secure Boot function. Options available: Enabled, Disabled. Default setting is Disabled .
Secure Boot Mode ^(Note)	Secure Boot requires all the applications that are running during the booting process to be pre-signed with valid digital certificates. This way, the system knows all files being loaded before the Operating System loads to the login screen have not been tampered with. When set to Standard, it will automatically load the Secure Boot keys form the BIOS databases. When set to Custom, you can customize the Secure Boot settings and manually load its keys from the BIOS database. Options available: Standard, Custom. Default setting is Standard .
Restore Factory Keys	Forces the system to user mode and installs factory default Secure Boot key database.
Reset To Setup Mode	Reset the system to Setup Mode.

(Note) Advanced items prompt when this item is set to **Custom**.

Parameter	Description
Key Management	<p data-bbox="335 156 665 180">Press [Enter] to configure advanced items.</p> <p data-bbox="335 185 936 235">Please note that this item is configurable when Secure Boot Mode is set to Custom.</p> <ul style="list-style-type: none"> <li data-bbox="335 243 941 352">◆ Factory Key Provision <ul style="list-style-type: none"> <li data-bbox="367 266 941 321">– Allows to provision factory default Secure Boot keys when system is in Setup Mode. <li data-bbox="367 326 904 352">– Options available: Enabled, Disabled. Default setting is Disabled. <li data-bbox="335 357 925 431">◆ Restore Factory Keys <ul style="list-style-type: none"> <li data-bbox="367 381 925 404">– Installs all factory default keys. It will force the system in User Mode. <li data-bbox="367 409 606 431">– Options available: Yes, No. <li data-bbox="335 435 654 517">◆ Reset To Setup Mode <ul style="list-style-type: none"> <li data-bbox="367 459 654 482">– Reset the system to Setup Mode. <li data-bbox="367 487 606 509">– Options available: Yes, No. <li data-bbox="335 522 899 603">◆ Enroll Efi Image <ul style="list-style-type: none"> <li data-bbox="367 545 899 603">– Press [Enter] to enroll SHA256 hash of the binary into Authorized Signature Database (db). <li data-bbox="335 608 936 682">◆ Export Secure Boot variables <ul style="list-style-type: none"> <li data-bbox="367 631 936 682">– Copy NVRAM content of Secure Boot variables to files in a root folder on a file system device. <li data-bbox="335 686 893 744">◆ Secure Boot variable <ul style="list-style-type: none"> <li data-bbox="367 710 893 744">– Displays the current status of the variables used for secure boot. <li data-bbox="335 749 803 854">◆ Platform Key (PK) <ul style="list-style-type: none"> <li data-bbox="367 773 803 796">– Displays the current status of the Platform Key (PK). <li data-bbox="367 801 675 823">– Press [Enter] to configure a new PK. <li data-bbox="367 827 601 854">– Options available: Update. <li data-bbox="335 859 941 995">◆ Key Exchange Keys (KEK) <ul style="list-style-type: none"> <li data-bbox="367 882 941 906">– Displays the current status of the Key Exchange Key Database (KEK). <li data-bbox="367 911 904 964">– Press [Enter] to configure a new KEK or load additional KEK from storage devices. <li data-bbox="367 969 670 995">– Options available: Update, Append. <li data-bbox="335 1000 941 1136">◆ Authorized Signatures (DB) <ul style="list-style-type: none"> <li data-bbox="367 1023 904 1047">– Displays the current status of the Authorized Signature Database. <li data-bbox="367 1052 941 1105">– Press [Enter] to configure a new DB or load additional DB from storage devices. <li data-bbox="367 1110 670 1136">– Options available: Update, Append. <li data-bbox="335 1141 899 1277">◆ Forbidden Signatures (DBX) <ul style="list-style-type: none"> <li data-bbox="367 1165 899 1188">– Displays the current status of the Forbidden Signature Database. <li data-bbox="367 1193 888 1246">– Press [Enter] to configure a new dbx or load additional dbx from storage devices. <li data-bbox="367 1251 670 1277">– Options available: Update, Append.

Parameter	Description
Key Management (continued)	<ul style="list-style-type: none"> ◆ Authorized TimeStamps (DBT) <ul style="list-style-type: none"> – Displays the current status of the Authorized TimeStamps Database. – Press [Enter] to configure a new DBT or load additional DBT from storage devices. – Options available: Update, Append. ◆ OsRecovery Signatures <ul style="list-style-type: none"> – Displays the current status of the OsRecovery Signature Database. – Press [Enter] to configure a new OsRecovery Signature or load additional OsRecovery Signature from storage devices. – Options available: Update, Append.

5-6 Boot Menu

The Boot menu allows you to set the drive priority during system boot-up. BIOS setup will display an error message if the legacy drive(s) specified is not bootable.

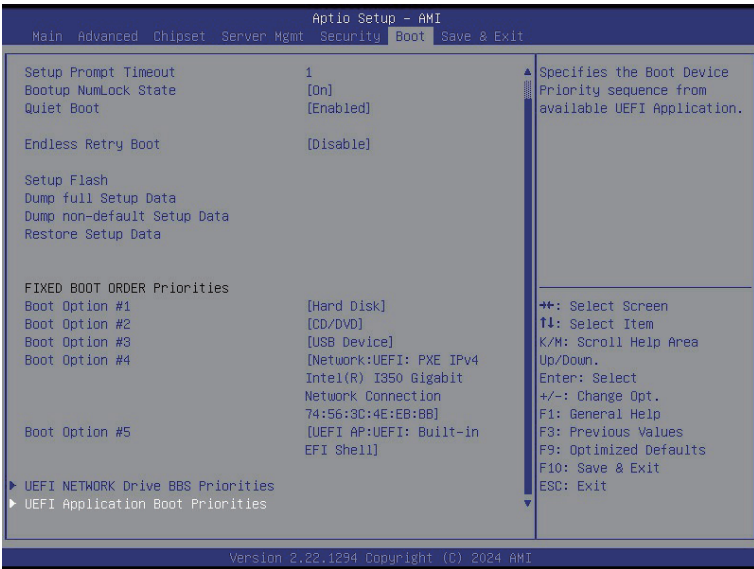
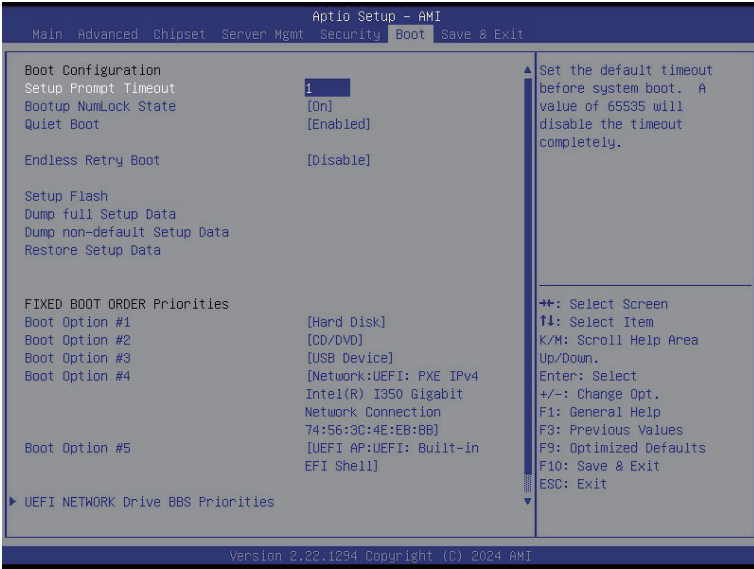

Parameter	Description
Boot Configuration	
Setup Prompt Timeout	Number of seconds to wait for setup activation key. 65535 (0xFFFF) means indefinite waiting. Press the numeric keys to input the desired values.
Bootup NumLock State	Enable/Disable the Bootup NumLock function. Options available: On, Off. Default setting is On .
Quiet Boot	Enable/Disable showing the logo during POST. Options available: Enabled, Disabled. Default setting is Enabled .
Endless Retry Boot	Options available: Disable, Enable. Default setting is Disable .
Setup Flash	Press [Enter] to run setup flash.
Dump full Setup Data	Press [Enter] to dump full setup data to file.
Dump non-default Setup Data	Press [Enter] to dump non-default setup data to file.
Restore Setup Data	Press [Enter] to restore setup data from file.
FIXED BOOT ORDER	
Priorities	
Boot Option #1 / #2 / #3 / #4 / #5	Press [Enter] to configure the boot order priority. By default, the server searches for boot devices in the following sequence: <ol style="list-style-type: none"> 1. Hard drive. 2. CD-COM/DVD drive. 3. USB device. 4. Network. 5. UEFI.
UEFI Network Drive BBS Priorities	Press [Enter] to configure the boot priority.
UEFI Application Boot Priorities	Press [Enter] to configure the boot priority.

5-7 Save & Exit Menu

The Save & Exit menu displays the various options to quit from the BIOS setup. Highlight any of the exit options then press <Enter>.

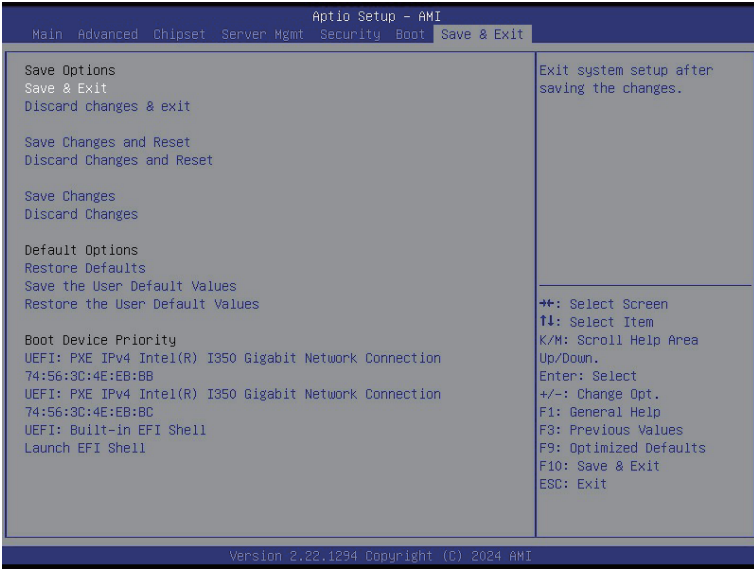

Parameter	Description
Save Options	
Save and Exit	Saves changes made and closes the BIOS setup. Options available: Yes, No.
Discard changes and exit	Discards changes made and exits the BIOS setup. Options available: Yes, No.
Save Changes and Reset	Restarts the system after saving the changes made. Options available: Yes, No.
Discard Changes and Reset	Restarts the system without saving any changes. Options available: Yes, No.
Save Changes	Saves changes done so far to any of the setup options. Options available: Yes, No.
Discard Changes	Discards changes made and closes the BIOS setup. Options available: Yes, No.
Default Options	

Parameter	Description
Restore Defaults	Loads the default settings for all BIOS setup parameters. Setup Defaults are quite demanding in terms of resources consumption. If you are using low-speed memory chips or other kinds of low-performance components and you choose to load these settings, the system might not function properly. Options available: Yes, No.
Save the User Default Values	Saves the changes made as the user default settings. Options available: Yes, No.
Restore the User Default Values	Loads the user default settings for all BIOS setup parameters. Options available: Yes, No.
Boot Device Priority	Press [Enter] to configure the device as the boot-up drive.
Launch EFI Shell	Attempts to Launch EFI Shell application (Shell.efi) from one of the available file system devices.

5-8 BIOS Recovery

The system has an embedded recovery technique. In the event that the BIOS becomes corrupt the boot block can be used to restore the BIOS to a working state. To restore your BIOS, please follow the instructions listed below:

Recovery Instruction:

1. Copy the XXX.rom to USB diskette.
2. Setting BIOS Recovery jump to enabled status.
3. Boot into BIOS recovery.
4. Run Proceed with flash update.
5. BIOS updated.

