

GIGABYTE™

G293-Z23-AAM1

HPC/AI Server - AMD EPYC™ 9005/9004 - 2U UP 4 x PCIe Gen5 GPUs

User Manual

Rev. 3.0

Copyright

© 2024 Giga Computing TECHNOLOGY CO., LTD. All rights reserved.

The trademarks mentioned in this manual are legally registered to their respective owners.

Disclaimer

Information in this manual is protected by copyright laws and is the property of Giga Computing. Changes to the specifications and features in this manual may be made by Giga Computing without prior notice. No part of this manual may be reproduced, copied, translated, transmitted, or published in any form or by any means without Giga Computing's prior written permission.

Documentation Classifications

In order to assist in the use of this product, Giga Computing provides the following types of documentation:

- User Manual: detailed information & steps about the installation, configuration and use of this product (e.g. motherboard, server barebones), covering hardware and BIOS.
- User Guide: detailed information about the installation & use of an add-on hardware or software component (e.g. BMC firmware, rail-kit) compatible with this product.
- Quick Installation Guide: a short guide with visual diagrams that you can reference easily for installation purposes of this product (e.g. motherboard, server barebones).

Please see the support section of the online product page to check the current availability of these documents.

For More Information

For related product specifications, the latest firmware and software, and other information please visit our website at <http://www.gigabyte.com/Enterprise>

Conventions

The following conventions are used in this user's guide:

	NOTE! Gives bits and pieces of additional information related to the current topic.
	CAUTION! Gives precautionary measures to avoid possible hardware or software problems.
	WARNING! Alerts you to any damage that might result from doing or not doing specific actions.

Server Warnings and Cautions

Before installing a server, be sure that you understand the following warnings and cautions.



WARNING!

To reduce the risk of electric shock or damage to the equipment:

- Do not disable the power cord grounding plug. The grounding plug is an important safety feature.
- Plug the power cord into a grounded (earthed) electrical outlet that is easily accessible at all times.
- Unplug all the power cords from the power supplies to disconnect power to the equipment.

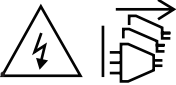

- Shock Hazard! Disconnect all power supply cords before servicing.
- Do not route the power cord where it can be walked on or pinched by items placed against it. Pay particular attention to the plug, electrical outlet, and the point where the cord extends from the server.



WARNING!

To reduce the risk of personal injury from hot surfaces, allow the drives and the internal system components to cool before touching them.



WARNING!

This server is equipped with high speed fans. Keep away from hazardous moving fan blades during servicing.



WARNING!

This equipment is intended to be used in Restricted Access Area. The access can only be gained by Skilled person. Only authorized by well trained professional person can access the restrict access location.



WARNING!

The equipment should only be repaired, maintained or replaced by skilled personnel.



CAUTION!

- Do not operate the server for long periods with the access panel open or removed. Operating the server in this manner results in improper airflow and improper cooling that can lead to thermal damage.
- Danger of explosion if battery is incorrectly replaced.
- Replace only with the same or equivalent type recommended by the manufacturer.
- Dispose of used batteries according to the manufacturer's instructions.



CAUTION!

Risk of explosion if battery is replaced incorrectly or with an incorrect type. Replace the battery only with the same or equivalent type recommended by the manufacturer. Dispose of used batteries according to the manufacturer's instructions.

Electrostatic Discharge (ESD)



CAUTION!

ESD CAN DAMAGE DRIVES, BOARDS, AND OTHER PARTS. WE RECOMMEND THAT YOU PERFORM ALL PROCEDURES AT AN ESD WORKSTATION. IF ONE IS NOT AVAILABLE, PROVIDE SOME ESD PROTECTION BY WEARING AN ANTI-STATIC WRIST STRAP ATTACHED TO CHASSIS GROUND -- ANY UNPAINTED METAL SURFACE -- ON YOUR SERVER WHEN HANDLING PARTS.

Always handle boards carefully. They can be extremely sensitive to ESD. Hold boards only by their edges without any component and pin touching. After removing a board from its protective wrapper or from the system, place the board component side up on a grounded, static free surface. Use a conductive foam pad if available but not the board wrapper. Do not slide board over any surface.

System power on/off: To remove power from system, you must remove the system from rack. Make sure the system is removed from the rack before opening the chassis, adding, or removing any non hot-plug components.

Hazardous conditions, devices and cables: Hazardous electrical conditions may be present on power, telephone, and communication cables. Turn off the system and disconnect the cables attached to the system before servicing it. Otherwise, personal injury or equipment damage can result.

Electrostatic discharge (ESD) and ESD protection: ESD can damage drives, boards, and other parts. We recommend that you perform all procedures in this chapter only at an ESD workstation. If one is not available, provide some ESD protection by wearing an antistatic wrist strap attached to chassis ground (any unpainted metal surface on the server) when handling parts.

ESD and handling boards: Always handle boards carefully. They can be extremely sensitive to electrostatic discharge (ESD). Hold boards only by their edges. After removing a board from its protective wrapper or from the system, place the board component side up on a grounded, static free surface. Use a conductive foam pad if available but not the board wrapper. Do not slide board over any surface.

Installing or removing jumpers: A jumper is a small plastic encased conductor that slips over two jumper pins. Some jumpers have a small tab on top that can be gripped with fingertips or with a pair of fine needle nosed pliers. If the jumpers do not have such a tab, take care when using needle nosed pliers to remove or install a jumper; grip the narrow sides of the jumper with the pliers, never the wide sides. Gripping the wide sides can damage the contacts inside the jumper, causing intermittent problems with the function controlled by that jumper. Take care to grip with, but not squeeze, the pliers or other tool used to remove a jumper, or the pins on the board may bend or break.

Table of Contents

Chapter 1	Hardware Installation	9
1-1	Installation Precautions	9
1-2	Product Specifications	10
1-3	System Block Diagram	14
Chapter 2	System Appearance	15
2-1	Front View	15
2-2	Rear View	15
2-3	Front Panel LED and Buttons	16
2-4	Rear System Button and LEDs	17
2-5	Power Supply Unit (PSU) LED	18
2-6	Hard Disk Drive LEDs	19
Chapter 3	System Hardware Installation	20
3-1	Removing Chassis Cover	21
3-2	Removing and Installing the Fan Duct	22
3-3	Installing the CPU and Heat Sink	23
3-4	Removing and installing the Heat Sink	24
3-5	Installing the Memory	25
3-5-1	12 Channel Memory Configuration	25
3-5-2	Installing a Memory	26
3-5-3	DIMM Population Table	27
3-5-4	Processor and Memory Module Matrix Table	29
3-6	Installing the GPU Card	30
3-7	Installing a PCI Express Card	34
3-8	Installing the Hard Disk Drive	38
3-9	Replacing the FAN Assembly	39
3-10	Replacing the Power Supply	42
3-11	Cable Routing	43
Chapter 4	Motherboard Components	49
4-1	Motherboard Components	49
4-2	Jumper Setting	50
4-3	Backplane Board Storage Connector	51
4-3-1	CBPE640	51
Chapter 5	BIOS Setup	52

5-1	The Main Menu	54
5-2	Advanced Menu	57
5-2-1	CPU Configuration.....	58
5-2-2	NVMe Configuration	59
5-2-3	SATA Configuration.....	60
5-2-4	USB Configuration.....	61
5-2-5	PCI Subsystem Settings.....	63
5-2-6	AST2600 Super IO Configuration	65
5-2-7	Serial Port Console Redirection	67
5-2-8	Network Stack Configuration	71
5-2-9	Post Report Configuration	72
5-2-10	Trusted Computing	73
5-2-11	PSP Firmware Versions.....	74
5-2-12	S5 RTC Wake Settings.....	75
5-2-13	Graphic Output Configuration.....	76
5-2-14	AMD Mem Configuration Status	77
5-2-15	Tls Auth Configuration	78
5-2-16	RAM Disk Configuration	79
5-2-17	iSCSI Configuration	80
5-2-18	Broadcom BCM57416 10GBASE-T Network Connection	81
5-2-19	VLAN Configuration.....	84
5-2-20	MAC IPv4 Network Configuration	85
5-2-21	MAC IPv6 Network Configuration	86
5-3	AMD CBS Menu.....	87
5-3-1	CPU Common Options	88
5-3-2	DF Common Options.....	94
5-3-3	UMC Common Options	102
5-3-4	NBIO Common Options.....	123
5-3-5	FCH Common Options	136
5-3-6	SOC Miscellaneous Control	144
5-3-7	CXL Common Options.....	146
5-4	AMD PBS Menu	148
5-4-1	RAS	149
5-4-2	Range Encryption	151
5-5	Chipset Setup Menu.....	152
5-5-1	North Bridge	153
5-6	Server Management Menu.....	154
5-6-1	System Event Log	156
5-6-2	View FRU Information	157
5-6-3	BMC VLAN Configuration.....	158
5-6-4	BMC Network Configuration	159
5-6-5	IPv6 BMC Network Configuration	160

5-7	Security Menu	161
5-7-1	Secure Boot	162
5-8	Boot Menu.....	164
5-9	Save & Exit Menu.....	166
5-10	BIOS Recovery	167
5-11	BIOS POST Beep code (AMI standard).....	168
5-11-1	PEI Beep Codes	168
5-11-2	DXE Beep Codes	168

Chapter 1 Hardware Installation

1-1 Installation Precautions

The motherboard/system contain numerous delicate electronic circuits and components which can become damaged as a result of electrostatic discharge (ESD). Prior to installation, carefully read the service guide and follow these procedures:

- Prior to installation, do not remove or break motherboard S/N (Serial Number) sticker or warranty sticker provided by your dealer. These stickers are required for warranty validation.
- Always remove the AC power by unplugging the power cord from the power outlet before installing or removing the motherboard or other hardware components.
- When connecting hardware components to the internal connectors on the motherboard, make sure they are connected tightly and securely.
- When handling the motherboard, avoid touching any metal leads or connectors.
- It is best to wear an electrostatic discharge (ESD) wrist strap when handling electronic components such as a motherboard, CPU or memory. If you do not have an ESD wrist strap, keep your hands dry and first touch a metal object to eliminate static electricity.
- Prior to installing the motherboard, please have it on top of an antistatic pad or within an electrostatic shielding container.
- Before unplugging the power supply cable from the motherboard, make sure the power supply has been turned off.
- Before turning on the power, make sure the power supply voltage has been set according to the local voltage standard.
- Before using the product, please verify that all cables and power connectors of your hardware components are connected.
- To prevent damage to the motherboard, do not allow screws to come in contact with the motherboard circuit or its components.
- Make sure there are no leftover screws or metal components placed on the motherboard or within the computer casing.
- Do not place the computer system on an uneven surface.
- Do not place the computer system in a high-temperature environment.
- Turning on the computer power during the installation process can lead to damage to system components as well as physical harm to the user.
- If you are uncertain about any installation steps or have a problem related to the use of the product, please consult a certified computer technician.







1-2 Product Specifications



NOTE:

We reserve the right to make any changes to the product specifications and product-related information without prior notice.

	System Dimension	<ul style="list-style-type: none"> ◆ 2U ◆ 448mm (W) x 87.5mm (H) x 800mm (D)
	CPU	<ul style="list-style-type: none"> ◆ AMD EPYC™ 9005 Series Processors ◆ AMD EPYC™ 9004 Series Processors ◆ Single processor, cTDP up to 400W^[1] - At ambient 25°C, cTDP up to 500W^[1] ◆ Please refer to the QVL on the support page or contact our sales representatives for verified CPU SKUs.
	Socket	<ul style="list-style-type: none"> ◆ 2 x LGA 6096 ◆ Socket SP5
	Chipset	<ul style="list-style-type: none"> ◆ System on Chip
	Memory	<ul style="list-style-type: none"> ◆ 12 x DIMM slots ◆ DDR5 memory supported ◆ 12-Channel memory architecture ◆ AMD EPYC™ 9005: ◆ RDIMM: Up to 6000 MT/s ◆ AMD EPYC™ 9004: ◆ RDIMM: Up to 4800 MT/s
	LAN	<p>Rear side:</p> <ul style="list-style-type: none"> ◆ 2 x 10Gb/s BASE-T LAN ports (1 x Broadcom® BCM57416) ◆ Support NCSI function ◆ 1 x 10/100/1000 management LAN
	Video	<ul style="list-style-type: none"> ◆ Integrated in Aspeed® AST2600 - 1 x VGA port
	Storage	<p>Front hot-swap:</p> <ul style="list-style-type: none"> ◆ 4 x 2.5" Gen5 NVMe/SATA/SAS^[1] ◆ 4 x 2.5" SATA/SAS ^[1] ◆ Internal M.2: ◆ 2 x M.2 (2280/22110), PCIe Gen5 x4 ◆ [1] SAS card is required to support SAS drives.

 SAS	Require SAS add-in cards
 RAID	Require RAID add-in cards
 Expansion Slot	<p>Riser Card CRSG627 x 2:</p> <ul style="list-style-type: none"> ◆ 2 x FHFL x16 (Gen5 x16), for GPUs <p>Riser Card CRSG628 x 2:</p> <ul style="list-style-type: none"> ◆ 2 x FHFL x16 (Gen5 x16), for GPUs <p>Riser Card CRSG01F x 2:</p> <ul style="list-style-type: none"> ◆ 2 x LP x16 (Gen5 x16) <p>[Note] Maximum GPU dimensions (LxWxH): 285 x 111.5 x 39.5mm. [Note] The system is only validated with a uniform GPU model.</p>
 Front I/O	<ul style="list-style-type: none"> ◆ 1 x Power button with LED ◆ 1 x ID button with LED ◆ 1 x Reset button ◆ 2 x LAN activity LEDs ◆ 1 x Storage activity LED ◆ 1 x System status LED
 Rear Panel I/O	<ul style="list-style-type: none"> ◆ 2 x USB 3.2 Gen1 ports (Type-A) ◆ 1 x VGA port ◆ 2 x RJ45 ports ◆ 1 x MLAN port ◆ 1 x Power button with LED ◆ 1 x ID button with LED ◆ 1 x NMI button ◆ 1 x Reset button ◆ 1 x System status LED
 Backplane I/O	<ul style="list-style-type: none"> ◆ Speed and bandwidth: PCIe Gen5 x4 or SATA 6Gb/s or SAS 12Gb/s
 TPM	<ul style="list-style-type: none"> ◆ 1 x TPM header with SPI interface - Optional TPM2.0 kit: CTM010



Power Supply





Dual 2200W 80 PLUS Titanium redundant power supply ^[1]

- ◆ AC Input:
 - 100-127V~/ 15.5A, 50-60Hz
 - 200-240V~/ 15.5A, 50-60Hz

- ◆ DC Input: (Only for China)
 - 240Vdc/ 16A

- ◆ DC Output:
 - Max 1000W/ 100-127V~
 - +12.2V/ 81A
 - +12Vsb/ 3A
 - Max 2200W/ 200-240V~ or 240Vdc Input
 - +12.2V/ 180A
 - +12Vsb/ 3A

^[1] The system power supply requires C19 type power cord

	System Management	<ul style="list-style-type: none"> ◆ Aspeed® AST2600 management controller ◆ GIGABYTE Management Console web interface ◆ Dashboard ◆ HTML5 KVM ◆ Sensor Monitor (Voltage, RPM, Temperature, CPU Status ...etc.) ◆ Sensor Reading History Data ◆ FRU Information ◆ SEL Log in Linear Storage / Circular Storage Policy ◆ Hardware Inventory ◆ Fan Profile ◆ System Firewall ◆ Power Consumption ◆ Power Control ◆ Advanced power capping ◆ LDAP / AD / RADIUS Support ◆ Backup & Restore Configuration ◆ Remote BIOS/BMC/CPLD Update ◆ Event Log Filter ◆ User Management ◆ Media Redirection Settings ◆ PAM Order Settings ◆ SSL Settings ◆ SMTP Settings
	OS Driver Supported	<ul style="list-style-type: none"> ◆ Please refer to OS compatibility table in support page
	Additional certifications	<ul style="list-style-type: none"> ◆ Windows Server 2022 (x64)
	System Fans	<ul style="list-style-type: none"> ◆ 4 x 80x80x38mm (16,500rpm)
	Operating Properties	<ul style="list-style-type: none"> ◆ Operating temperature: 10°C to 35°C ◆ Operating humidity: 8%-80% (non-condensing) ◆ Non-operating temperature: -40°C to 60°C ◆ Non-operating humidity: 20%-95% (non-condensing) <p>NOTE: Please contact Technical Support for more information about optimized GPU system operating temperature</p>

1-3 System Block Diagram

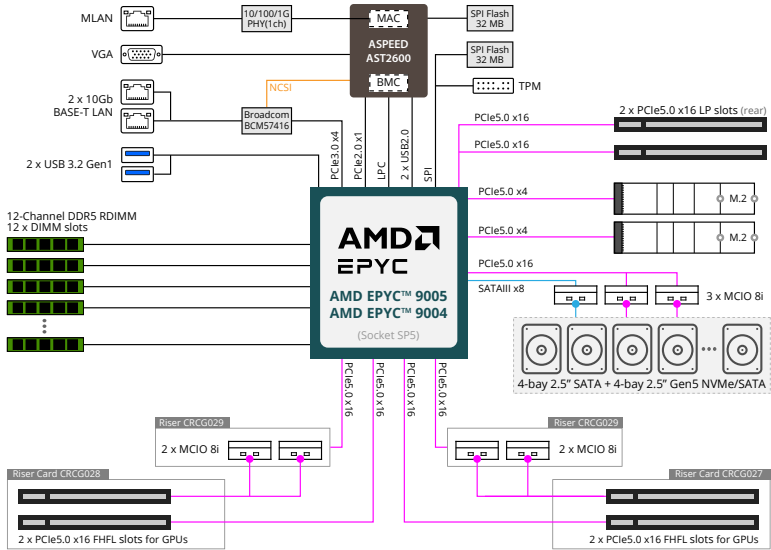

Chapter 2 System Appearance

2-1 Front View



No.	Description
1.	Front Panel LED and Buttons
NOTE! Green HDD Latch Supports NVMe	



• Please Go to Chapter 2-3 **Front Panel LED and Buttons** for detail description of function LEDs.

2-2 Rear View

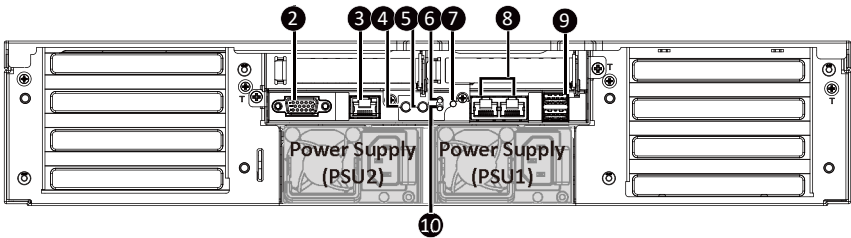

No.	Description	No.	Description
2.	VGA Port	7.	System Status LED
3.	10/100/1000 Server Management LAN Port	8.	10GbE LAN Port x 2
4.	Power Button with LED	9.	USB 3.0 Port x 2
5.	ID Button	10.	NMI Button
6.	Reset Button		

2-3 Front Panel LED and Buttons

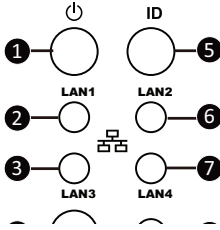

No.	Name	Color	Status	Description
1.	Power button with LED	Green	On	System is powered on
		N/A	Off	System is not powered on or in ACPI S5 state (power off)
2.	ID Button			Press the button to activate system identification
3/4.	LAN 1/2 Active/Link LEDs	Green	Solid On	Link between system and network or no access.
		Green	Blink	Data transmission or receiving is occurring
		N/A	Off	No data transmission or receiving is occurring
5.	HDD Status LED	Green	On	HDD locate
			Blink	HDD access
		Amber	On	HDD fault
		Green/Amber	Blink	HDD rebuilding
		N/A	Off	No HDD access or no HDD fault.
6.	System Status LED	Green	Solid On	System is operating normally.
			Solid On	Critical condition, may indicate: System fan failure System temperature
		Amber	Blink	Non-critical condition, may indicate: Redundant power module failure Temperature and voltage issue Chassis intrusion
			N/A	Off
7.	Reset Button			Press the button to reset the system.

2-4 Rear System Button and LEDs

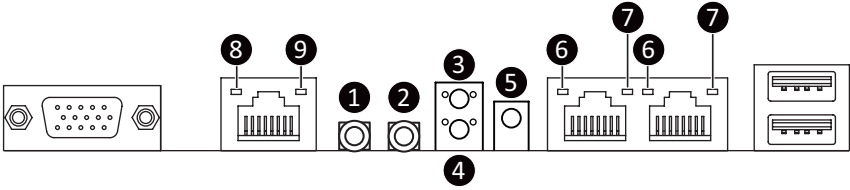

No.	Name	Color	Status	Description
1.	Power Button with LED	Green	On	System is powered on
		N/A	Off	System is not powered on or in ACPI S5 state (power off)
2.	ID Button			Press the button to activate system identification
3.	Reset Button			Press the button to reset the system.
4.	NMI button			Press the button server generates a NMI to the processor if the multiple-bit ECC errors occur, which effectively halt the server.
5.	System Status LED	Green	Solid On	System is operating normally.
		Amber	Solid On	Critical condition, may indicate: System fan failure System temperature
			Blink	Non-critical condition, may indicate: Redundant power module failure Temperature and voltage issue Chassis intrusion
		N/A	Off	System is not ready, may indicate: POST error NMI error Processor or terminator missing
6.	10GbE Speed LED	Green	On	10 Gbps data rate
		Yellow	On	5Gbps, 2.5Gbps, 1Gbps data rate
		N/A	Off	100 Mbps data rate
7.	10GbE Link / Activity LED	Green	On	Link between system and network or no access
			Blink	Data transmission or reception is occurring.
		N/A	Off	No data transmission or reception is occurring.
8.	1GbE Speed LED	Yellow	On	1 Gbps data rate
		Green	On	100 Mbps data rate
		N/A	Off	10 Mbps data rate
9.	1GbE Link / Activity LED	Green	On	Link between system and network or no access
			Blink	Data transmission or reception is occurring.
		N/A	Off	No data transmission or reception is occurring.

2-5 Power Supply Unit (PSU) LED

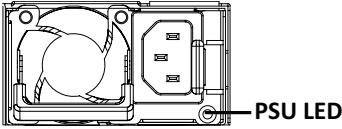

State	Description
OFF	No AC power to all power supplies
1Hz Green Blinking	AC present / only standby on / Cold redundant mode
2Hz Green Blinking	Power supply firmware updating mode
Amber	AC cord unplugged or AC power lost; with a second power supply in parallel still with AC input power
	Power supply critical event causing shut down: failure, OCP, OVP, fan failure and UVP
1Hz Amber Blinking	Power supply warning events where the power supply continues to operate: high temp, high power, high current and slow fan

2-6 Hard Disk Drive LEDs

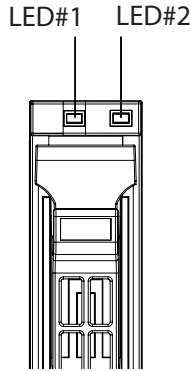

RAID SKU		LED1	Locate	HDD Fault	Rebuilding	HDD Access	HDD Present (No Access)
No RAID configuration (via PCH, HBA)	Disk LED (LED on Back Panel)	Green	ON(*1)	OFF		BLINK (*2)	OFF
		Amber	OFF	OFF		OFF	OFF
	Removed HDD Slot (LED on Back Panel)	Green	ON(*1)	OFF		--	--
		Amber	OFF	OFF		--	--
RAID configuration (via HW RAID Card or SW RAID Card)	Disk LED	Green	ON	OFF		BLINK (*2)	OFF
		Amber	OFF	ON	(Low Speed: 2 Hz)	OFF	OFF
	Removed HDD Slot	Green	ON(*1)	OFF	(*3)	--	--
		Amber	OFF	ON	(*3)	--	--

LED 2	HDD Present	No HDD
Green	ON	OFF

NOTE:

*1: Depends on HBA/Utility Spec.

*2: Blink cycle depends on HDD's activity signal.

*3: If HDD is pulled out during rebuilding, the disk status of this HDD is regarded as faulty.

Chapter 3 System Hardware Installation



Pre-installation Instructions

Computer components and electronic circuit boards can be damaged by discharges of static electricity. Working on computers that are still connected to a power supply can be extremely dangerous. Follow the simple guidelines below to avoid damage to your computer or injury to yourself.

- Always disconnect the computer from the power outlet whenever you are working inside the computer case.
- If possible, wear a grounded wrist strap when you are working inside the computer case. Alternatively, discharge any static electricity by touching the bare metal system of the computer case, or the bare metal body of any other grounded appliance.
- Hold electronic circuit boards by the edges only. Do not touch the components on the board unless it is necessary to do so. Do not flex or stress the circuit board.
- Leave all components inside the static-proof packaging until you are ready to use the component for the installation.

3-1 Removing Chassis Cover



Before you remove or install the system cover

- Make sure the system is not turned on or connected to AC power.

Follow these instructions to remove the system cover:

1. Remove the eight screws securing the cover.
2. Slide the cover towards the rear and remove the cover in the direction of the arrow.

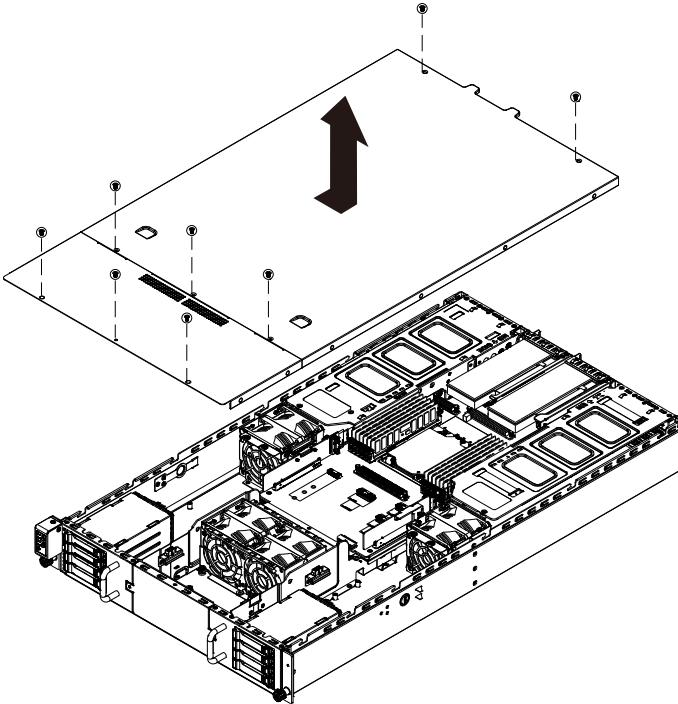

3-2 Removing and Installing the Fan Duct

Follow these instructions to remove/install the fan duct:

1. Lift up to remove the fan duct
2. To install the fan duct, align the tabs at the front of the fan duct with the slots in the system fan compartment as shown in the image below, and then push down the fan duct into chassis until its firmly seats

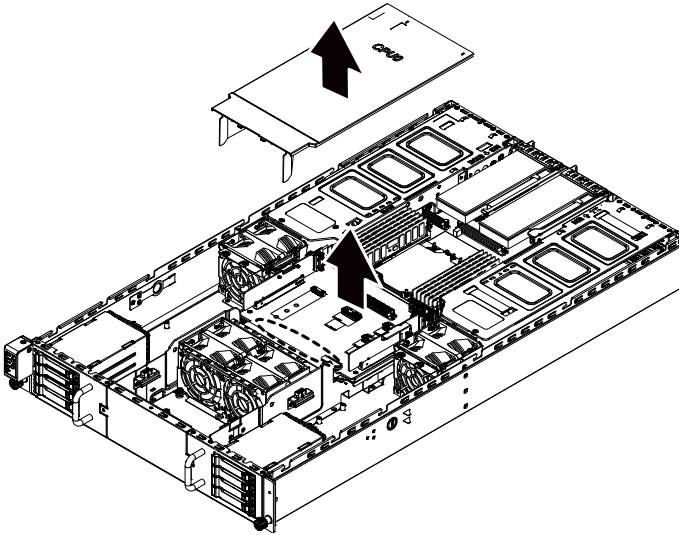

3-3 Installing the CPU and Heat Sink



Read the following guidelines before you begin to install the CPU:

- Make sure that the motherboard supports the CPU.
- Always turn off the computer and unplug the power cord from the power outlet before installing the CPU to prevent hardware damage.
- Unplug all cables from the power outlets.
- Disconnect all telecommunication cables from their ports.
- Place the system unit on a flat and stable surface.
- Open the system according to the instructions.



WARNING!

Failure to properly turn off the server before you start installing components may cause serious damage. Do not attempt the procedures described in the following sections unless you are a qualified service technician.

Follow these instructions to install the CPU:

1. Align and install the processor on the carrier.
NOTE: Apply thermal compound evenly on the top of the CPU. Remove the protective cover from the underside of the heat sink.
2. Carefully flip the heat sink cover. Then install the carrier assembly on the bottom of the heat sink and make sure the gold arrow is located in the correct direction.
3. Remove the CPU cover.
NOTE: Save the CPU cover in the event that you need to remove the CPU from the socket.
4. Align the heat sink with the CPU socket by the guide pins and make sure the gold arrow is located in the correct direction. Then place the heat sink onto the top of the CPU socket.
5. Position the rotating wires into the latch position.
6. Tighten the screws in a sequential order (1→2→3→4).
NOTE: When disassembling the heat sink, loosen the screws in reverse order (4→3→2→1) and then move the rotating wires into the unlatch position.

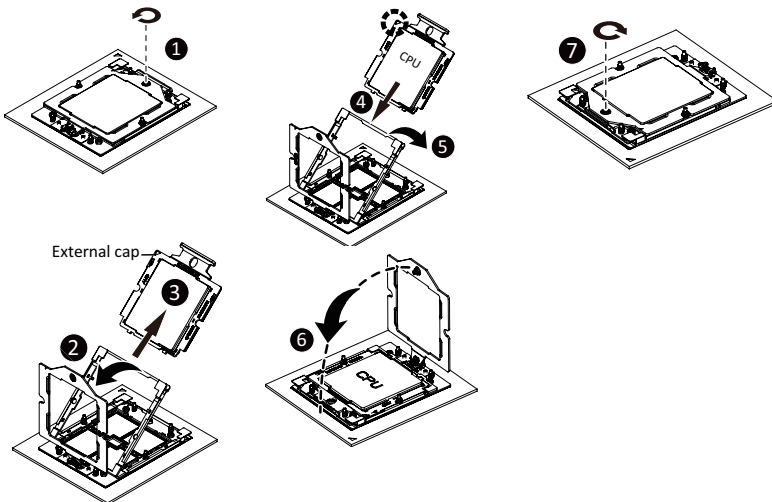

3-4 Removing and installing the Heat Sink



Read the following guidelines before you begin to remove/install the heat sink:

- Always turn off the computer and unplug the power cord from the power outlet before installing the heat sink to prevent hardware damage.
- Unplug all cables from the power outlets.
- Disconnect all telecommunication cables from their ports.
- Place the system unit on a flat and stable surface.
- Open the system according to the instructions.



WARNING!

Failure to turn off the server before you start installing components may cause serious damage. Do not attempt the procedures described in the following sections unless you are a qualified service technician.

Follow these instructions to remove/install the heat sink:

1. Loosen the captive screws securing the heat sink in place in reverse order (6→5→4→3→2→1).
2. Lift and remove the heat sink from the system.
3. To reinstall the heat sink reverse steps 1-2 while ensuring that you tighten the captive screws in sequential order (1→2→3→4→5→6) as seen in the image below.

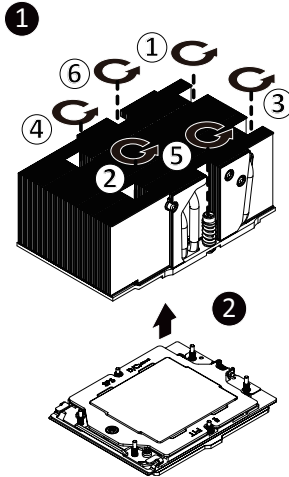

- When installing the heat sink to CPU, use a Torx T20 screwdriver to tighten 6 captive nuts in sequence as 1-6. The screw tightening torque: 13.5 ± 0.5 kgf-cm.
- To ensure the system operates properly, make sure the heatsink is seated on the processor firmly.

3-5 Installing the Memory



Read the following guidelines before you begin to install the memory:

- Make sure that the motherboard supports the memory. It is recommended that memory of the same capacity, brand, speed, and chips be used.
- Always turn off the computer and unplug the power cord from the power outlet before installing the memory to prevent hardware damage.
- Memory modules have a foolproof design. A memory module can be installed in only one direction. If you are unable to insert the memory, switch the direction.

3-5-1 12 Channel Memory Configuration

This motherboard provides 12 DDR5 memory sockets and supports 12 Channel Technology. After the memory is installed, the BIOS will automatically detect the specifications and capacity of the memory.

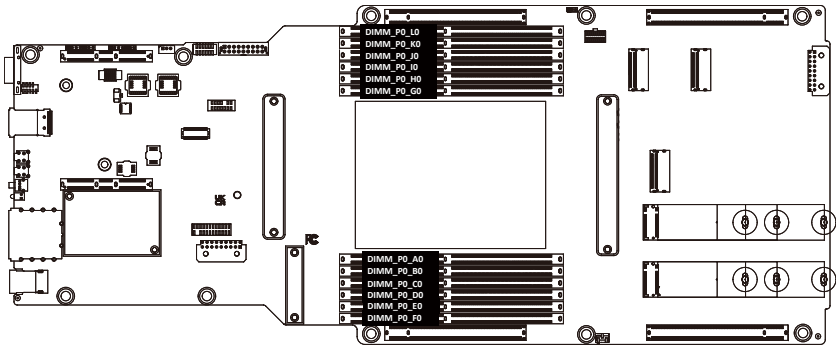

3-5-2 Installing a Memory



Before installing a memory module, make sure to turn off the computer and unplug the power cord from the power outlet to prevent damage to the memory module.

Be sure to install DDR4 DIMMs on this motherboard.

Follow these instructions to install the Memory:

1. Insert the DIMM memory module vertically into the DIMM slot, and push it down.
2. Close the plastic clip at both edges of the DIMM slots to lock the DIMM module.
3. Reverse the installation steps when you want to remove the DIMM module.

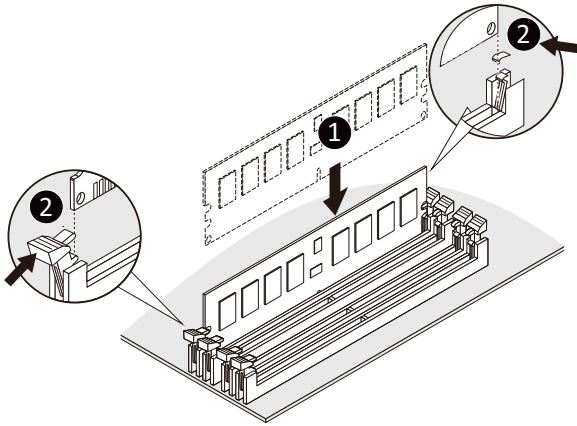

3-5-3 DIMM Population Table

EPYC Memory Speed based on DIMM Population (One DIMM per Channel)

DIMM Type	DIMM Population	DDR5 Frequency MT/s ^{1,2}		
		6400 MT/s Grade DIMM ³	5600 MT/s Grade DIMM ³	4800 MT/s Grade DIMM ³
RDIMM	1R (1 rank)	6000	5600	4800
	2R (2 ranks)	6000	5600	4800
3DS RDIMM*	2R xH	6000 ⁴	5600	4800
MRDIMM (1:1) ⁵	4R (4 ranks)	6000 ⁴		

*For 3DS RDIMM	When x = 2	DIMM Ranks = 4
	When x = 4	DIMM Ranks = 8
	When x = 8 ⁵	DIMM Ranks = 16

Note:

- When only one DIMM is used, it must be populated in memory slot DIMM1.
1. Frequency subject to change based on validation.
 2. Maximum frequency references 14L 74mil low-Dk PCB stackup.
 3. 6000 MT/s pending ecosystem enablement.
 4. MRDIMM will be evaluated as a post-PR feature, pending ecosystem readiness.
 5. 3DS RDIMM at 2 Rank (8H DRAM Pkgs) will be a post-PR feature, pending ecosystem readiness.

EPYC Memory Speed based on DIMM Population (Two DIMM per Channel)

DIMM Type	DIMM Population		DDR5 Frequency MT/s ^{1,2,3}		
	DIMM0	DIMM1	6400 MT/s Grade DIMM	5600 MT/s Grade DIMM	4800 MT/s Grade DIMM
RDIMM	--	1R	5200	4800	4800
	1R	1R	4400	4000	4000
	--	2R	5200	4800	4800
	2R	2R	4000	3600	3600
3DS RDIMM*	--	2R xH	5200	4800	4800
	2R xH	2R xH	4000	3600	3600

*For 3DS RDIMM	When x = 2	DIMM Ranks = 4
	When x =4	DIMM Ranks = 8
	When x = 8 ⁴	DIMM Ranks = 16

Note:

- When only one DIMM is used, it must be populated in memory slot DIMM1.
1. Frequency subject to change based on validation.
 2. Maximum frequency references 14L 74mil low-Dk PCB stackup.
 3. 62DPC (2-of-2) mixing of DIMM, RCD, and/or PMIC vendor within a memory channel to be supported for 6400 MT/s speed-grade DIMMs only, beginning in TurinPI-SP5_1.0.0.0..
 4. 3DS RDIMM at 2 Rank (8H DRAM Pkgs) will be a post-PR feature, pending ecosystem readiness.

3-5-4 Processor and Memory Module Matrix Table

Memory Q'ty	CPU0											
	F0	E0	D0	C0	B0	A0	G0	H0	I0	J0	K0	L0
1 DIMM						V						
2 DIMM						V	V					
4 DIMM				V		V	V		V			
6 DIMM				V	V	V	V	V	V			
8 DIMM		V		V	V	V	V	V	V		V	
10 DIMM		V	V	V	V	V	V	V	V	V	V	
12 DIMM	V	V	V	V	V	V	V	V	V	V	V	V



NOTE!

- DIMM must be populated in sequential alphabetic order, starting with bank A.
- When only one DIMM is used, it must be populated in memory slot C0.

3-6 Installing the GPU Card



- Voltages can be present within the server whenever an AC power source is connected. This voltage is present even when the main power switch is in the off position. Ensure that the system is powered-down and all power sources have been disconnected from the server prior to installing a PCI card.

Failure to observe these warnings could result in personal injury or damage to equipment.



- The PCI riser assembly does not include a riser card or any cabling as standard. To install a PCI card, a riser card must be installed.

For Slot1/Slot2

Follow these instructions to install the GPU card:

1. [For Slot1/Slot2] Loosen and remove the single screw at the top of the system and the two screws at the rear of the system securing the PCI cage.
2. Pull the two plastic handles to lift up the PCI cage from the system.
3. Insert the card into the selected slot. Make sure that the card is properly seated.
4. Secure the GPU cards in place with two screws.

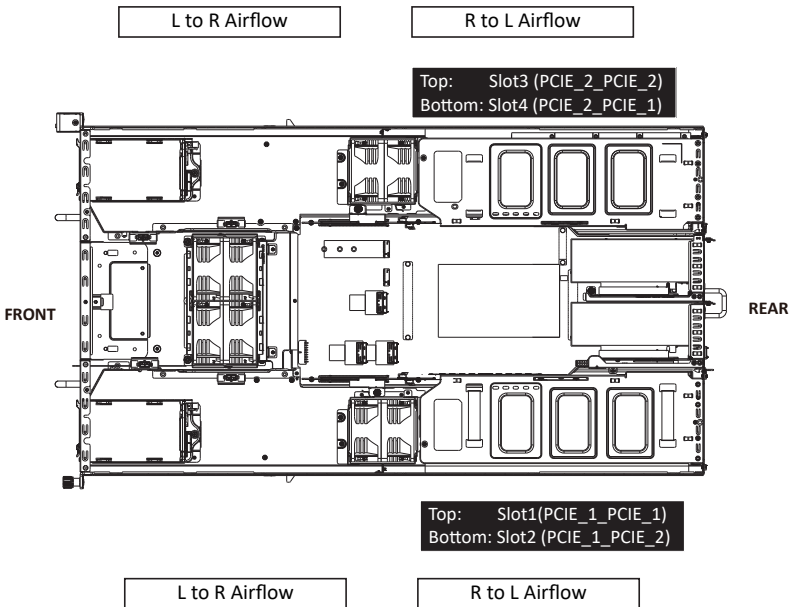

(For Slot1/Slot2)

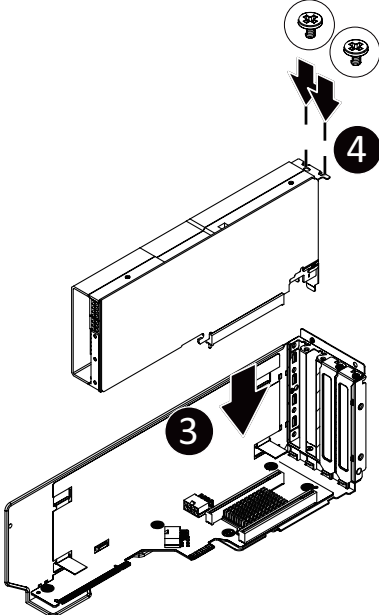
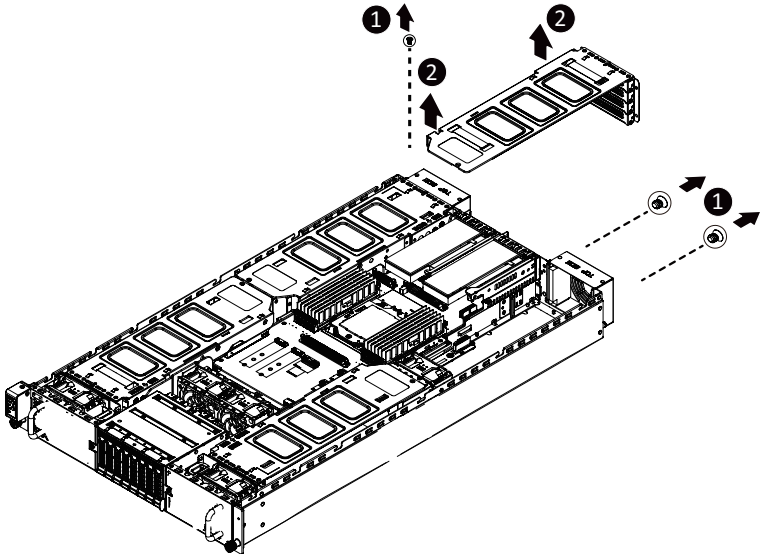

For Slot3/Slot4

Follow these instructions to install the GPU card:

1. [For Slot3/Slot4] Loosen and remove the single screw at the top of the system and the two screws at the rear of the system securing the PCI cage. Pull the two plastic handles to lift up the PCI cage from the system.
2. Insert the card into the selected slot. Make sure that the card is properly seated.
3. Secure the GPU cards in place with two screws.

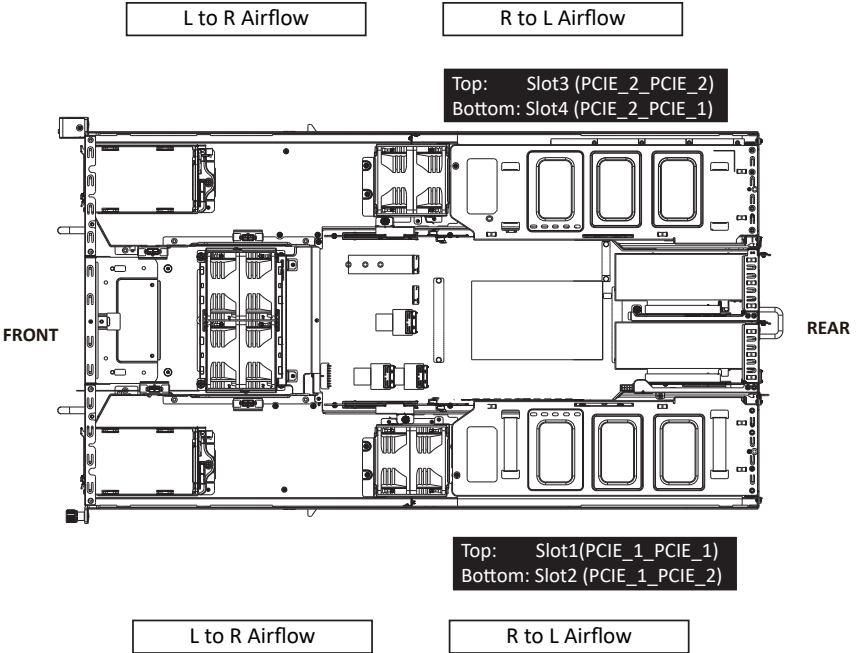

(For Slot3/Slot4)

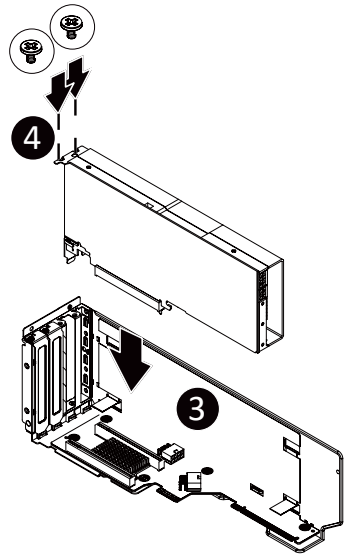
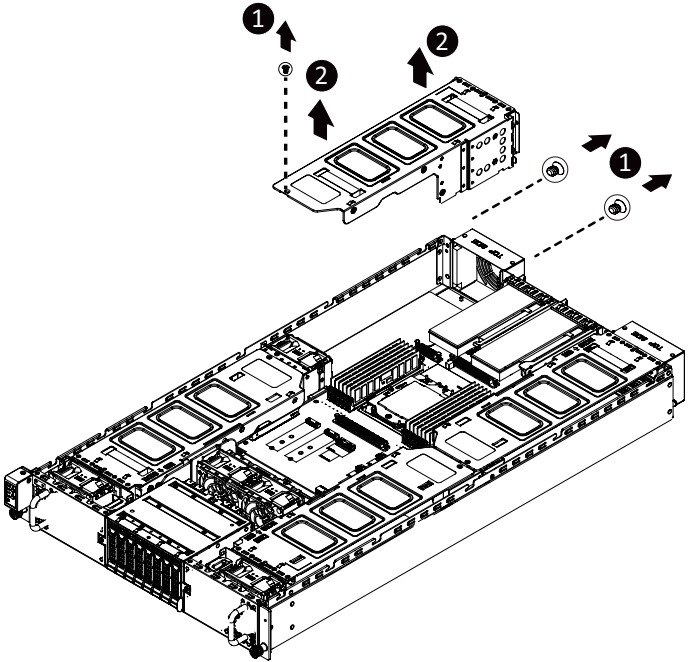

3-7 Installing a PCI Express Card



- Voltages can be present within the server whenever an AC power source is connected. This voltage is present even when the main power switch is in the off position. Ensure that the system is powered-down and all power sources have been disconnected from the server prior to installing a PCI card.

Failure to observe these warnings could result in personal injury or damage to equipment.

Follow these instructions to install a PCI Express x8 card on right side of the system:

1. Loosen and remove the two screws securing the PCI Express card bracket on the right side of the system.
2. Remove the PCI Express card bracket from the system.
3. Install the PCI Express card into the bracket.
4. Secure the PCI Express card to the bracket with one screw.
5. Install the PCI Express card bracket with card back into the system, ensure that the connector on the bracket is securely installed into the connector on the motherboard as shown.
6. Secure the PCI Express card bracket with card to the system with two (2) screws.

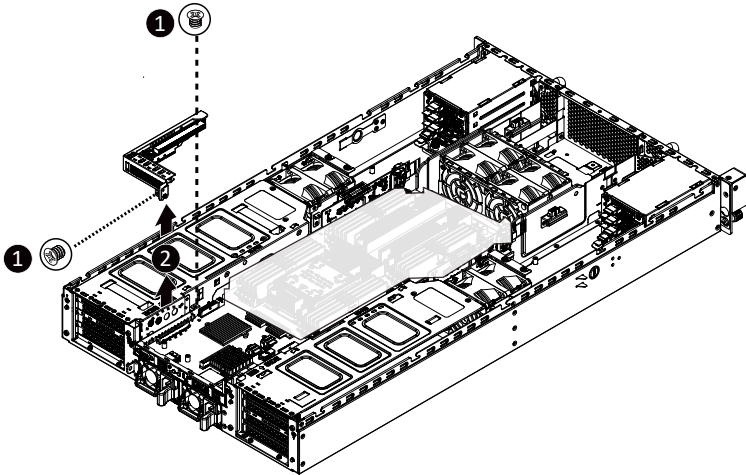

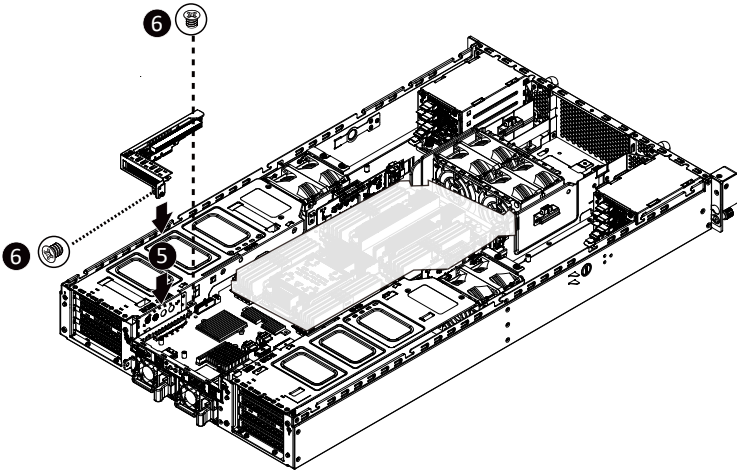
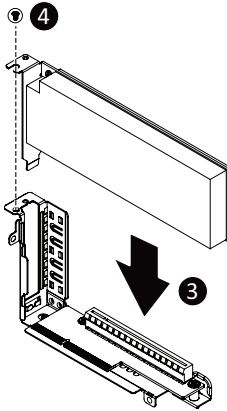

Follow these instructions to install a PCI Express x16 card on left side of the system:

1. Loosen the thumbnail screw securing the PCI Express card bracket on the left side of the system.
2. Remove the PCI Express card bracket from the system.
3. Install the PCI Express card into the bracket.
4. Secure the PCI Express card to the bracket with one screw.
5. Install the PCI Express card bracket with card back into the system, ensure that the connector on the bracket is securely installed into the connector on the motherboard as shown.
6. Secure the PCI Express card bracket with card to the system using the thumbnail screw.

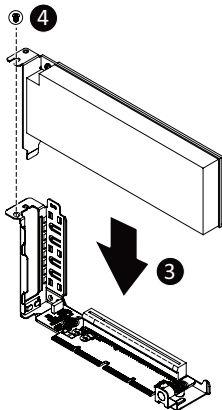
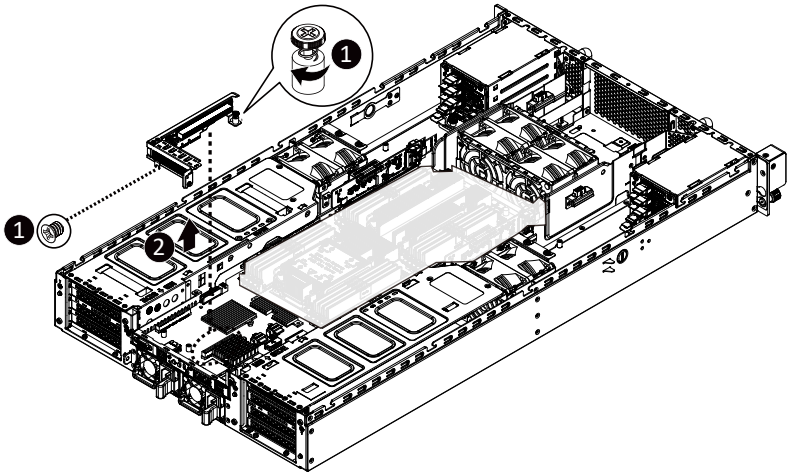

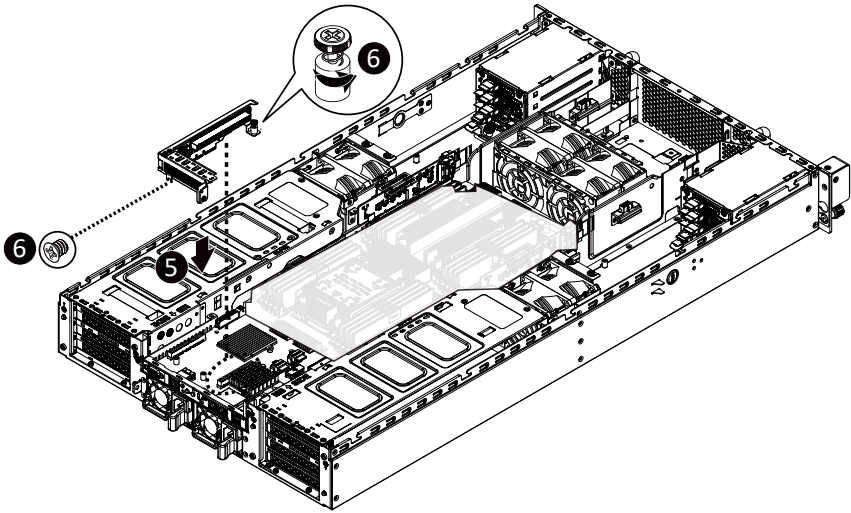

3-8 Installing the Hard Disk Drive



Read the following guidelines before you begin to install the Hard disk drive:

- Take note of the drive tray orientation before sliding it out.
- The tray will not fit back into the bay if inserted incorrectly.
- Make sure that the HDD is connected to the HDD connector on the backplane.

Follow these instructions to install a 2.5" hard disk drive:

1. Press the release button.
2. Extend the locking lever.
3. Pull the locking lever in the direction indicated to remove the HDD tray.
4. Align the hard disk drive with the positioning stud on the HDD tray.
5. Slide the hard disk drive into the HDD tray.
6. Reinsert the HDD tray into the slot and close the locking lever.



CAUTION!

We strongly recommend using enterprise level hard disk drives in the Gigabyte server system. For more information of recommended HDDs, please visit the Gigabyte website:

<https://www.gigabyte.com> and search for the specific product QVL from **Support & Downloads**.

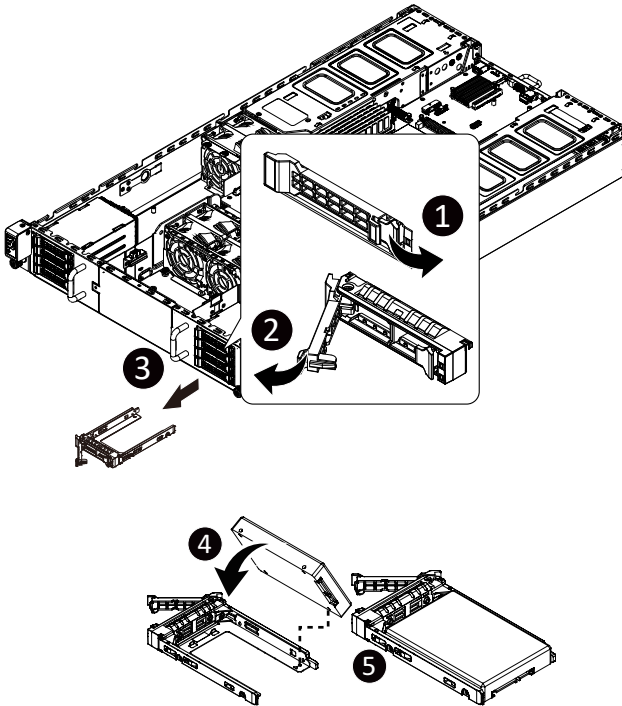

3-9 Replacing the FAN Assembly



CAUTION!

Before you remove or install the system fans follow these steps:

- Make sure the system is not turned on or connected to the AC power..
- Disconnect all necessary cable connections. Failure to observe these warnings could result in personal injury or damage to the equipment.

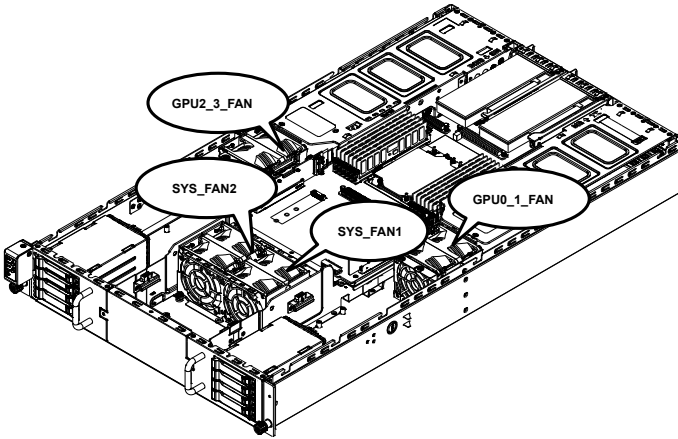

Follow these instructions to replace the fan assembly:

[For GPU2_3_FAN/GPU0_1_FAN]

1. Disconnect the fan cable and then lift up the fan assembly from the chassis.
2. Reverse the previous steps to install the replacement fan assembly.

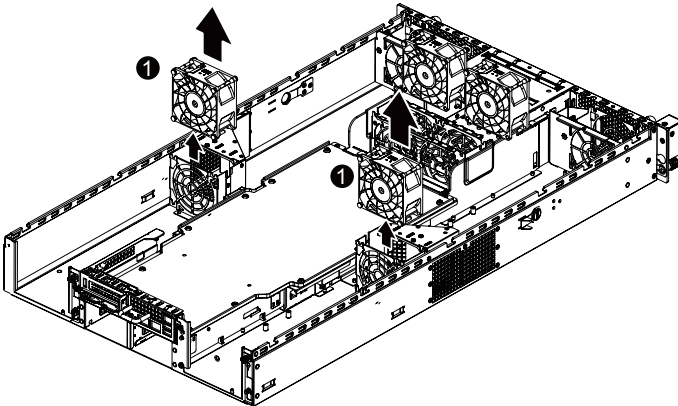

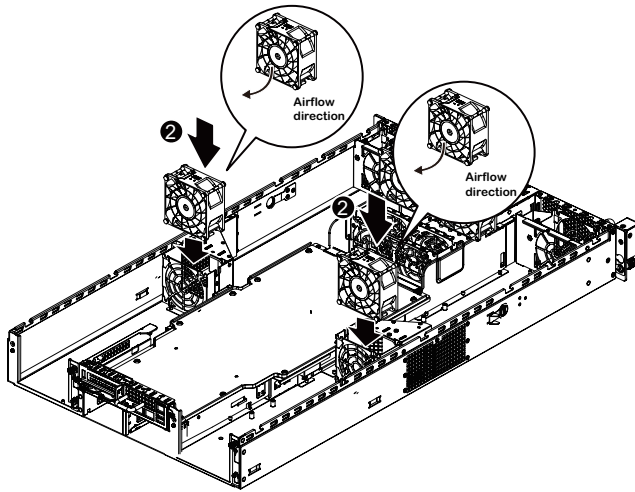

[For SYS_FAN1/SYS_FAN2]

1. Disconnect the fan cable and then lift up the fan assembly from the chassis.
2. Reverse the previous steps to install the replacement fan assembly.

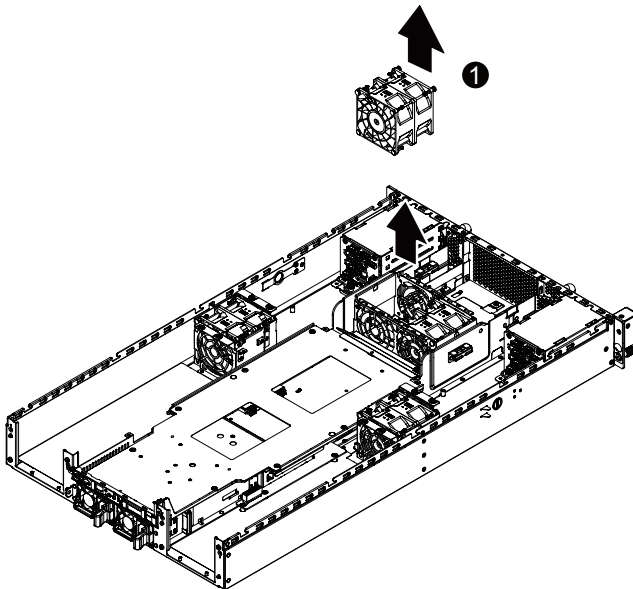

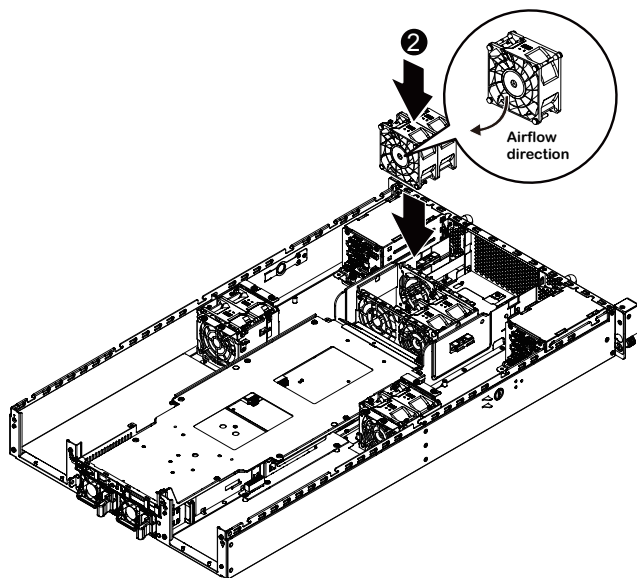

3-10 Replacing the Power Supply



CAUTION!

- In order to reduce the risk of injury from electric shock, disconnect AC power from the power supply before removing it from the system.

Follow these instructions to replace the power supply:

1. Pull up the power supply handle and press the retaining clip on the right side of the power supply along the direction of the arrow.
2. At the same time, pull out the power supply using the handle.
3. Insert the replacement power supply firmly into the chassis. Connect the AC power cord to the replacement power supply.

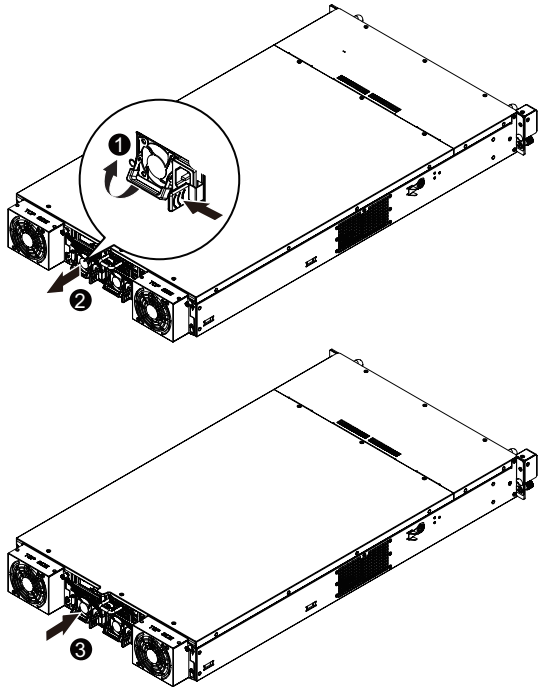

CAUTION!

- Please see the illustration below for installation sequence.

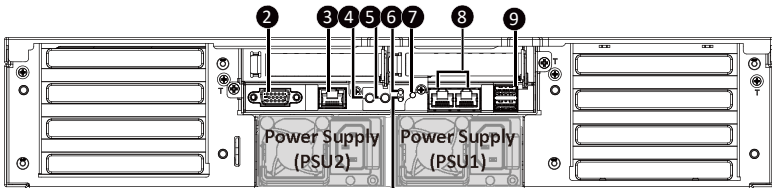

3-11 Cable Routing

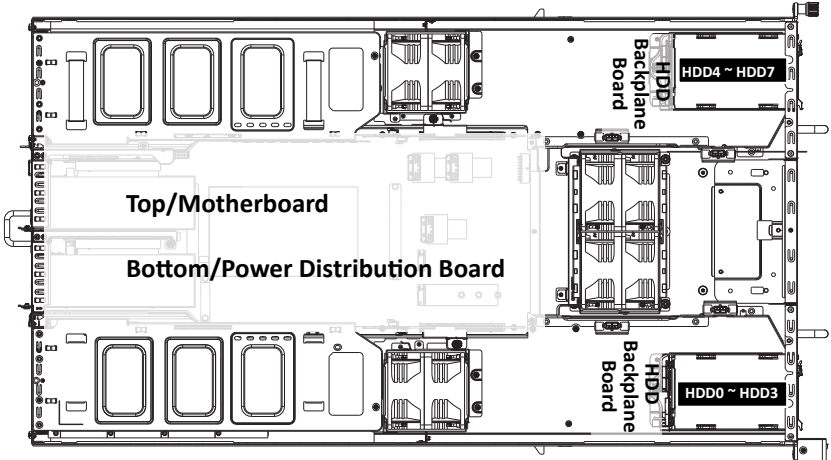

Front Panel IO Cable

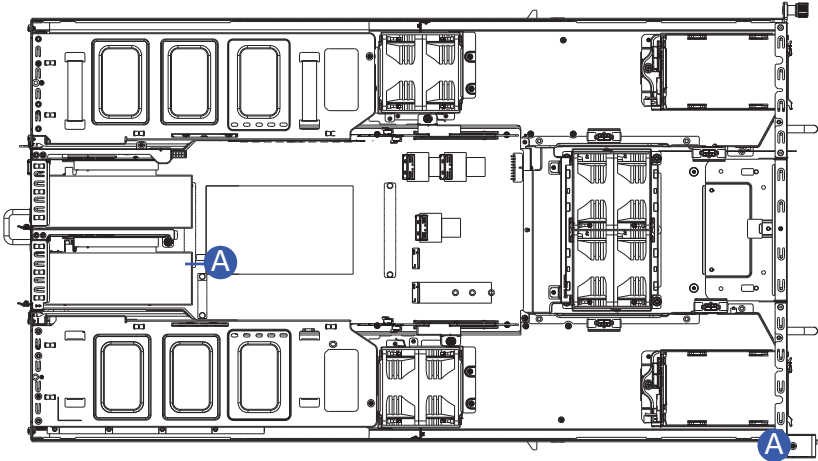

A	Front Switch/LED Cable	Motherboard	FP_1
		Front IO Board	FP_1

Motherboard / HDD Backplane Board

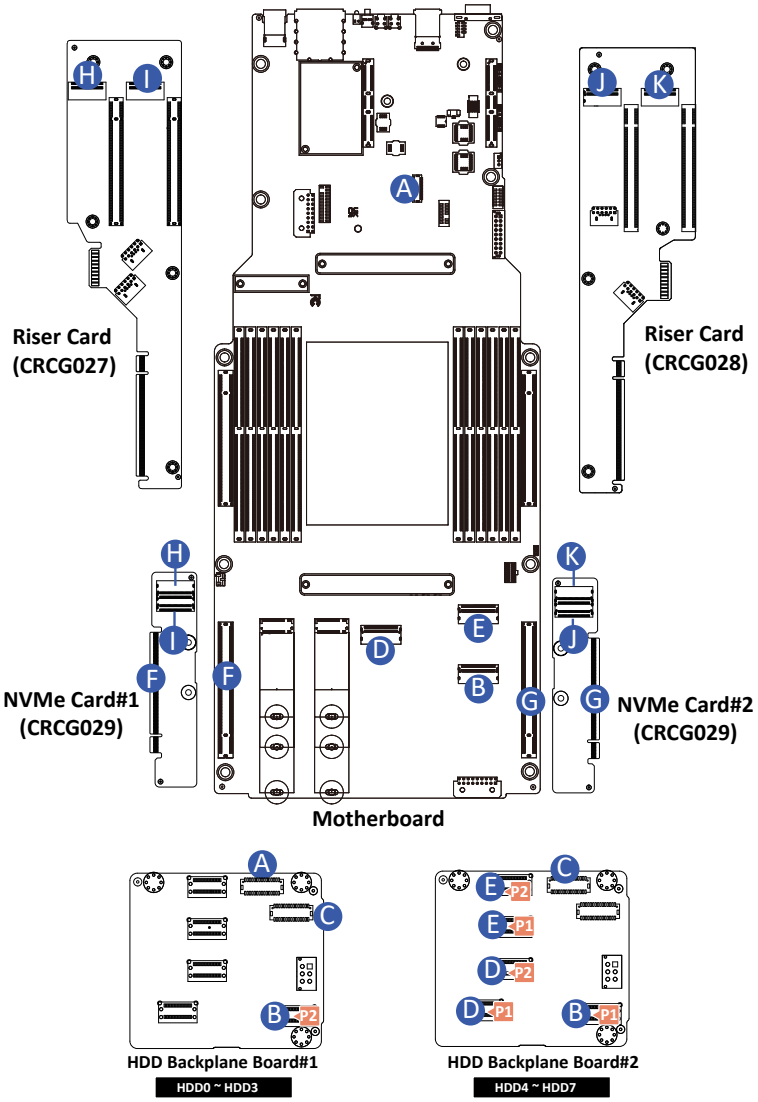

A	BP Signal Cable	Motherboard	BP_1
		HDD Backplane Board#1	BP_1
B	NVMe Cable	Motherboard	P0_G3_S
		HDD Backplane Board#2	SL_CN1(MCIO 4I Cable P1)
		HDD Backplane Board#1	SL_CN1(MCIO 4I Cable P2)
C	BP Signal Cable	HDD Backplane Board#1	BP_SERIES
		HDD Backplane Board#2	BP_1
D	NVMe Cable	Motherboard	P0_G1
		HDD Backplane Board#2	U2_2 (MCIO 4I Cable P2)
			U2_3 (MCIO 4I Cable P1)
E	NVMe Cable	Motherboard	P0_G3_U
		HDD Backplane Board#2	U2_0 (MCIO 4I Cable P2)
			U2_1 (MCIO 4I Cable P1)
F	NVMe Cable	NVMe Card#1	
		Motherboard	PCIe x16 Slot #4
G	NVMe Cable	NVMe Card#2	
		Motherboard	PCIe x16 Slot #3
H	NVMe Cable	NVMe Card#1	MCIO_2
		Riser Card(CRCG027)	MCIO_2
I	NVMe Cable	NVMe Card#1	MCIO_1
		Riser Card(CRCG027)	MCIO_1
J	NVMe Cable	NVMe Card#2	MCIO_1
		Riser Card(CRCG028)	MCIO_1
K	NVMe Cable	NVMe Card#2	MCIO_2
		Riser Card(CRCG028)	MCIO_2

Motherboard / Power Distribution Board

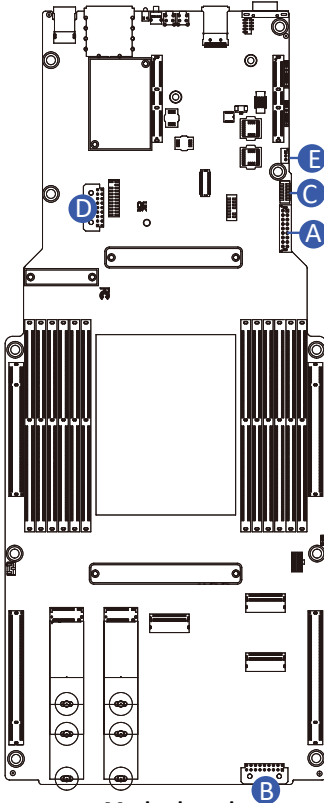

Motherboard

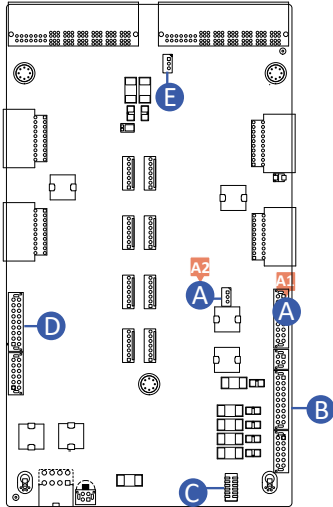

Power Distribution Board

A	ATX Power Cable (2x9)	Motherboard	ATX_2X9P
		Power Distribution Board	SSI_2X9P1(A1)
B	ATX Power Cable (2x9)	Motherboard	ATX2_1
		Power Distribution Board	ATX2_1
C	SMD Cable	Motherboard	FP_2
		Power Distribution Board	F_PANEL
D	CPU Power Cable (2x9)	Motherboard	ATX1_1
		Power Distribution Board	ATX1_1
E	Signal Cable (1x3)	Motherboard	JP12V_STBY
		Power Distribution Board	P12V_STBY

Power Distribution board / HDD Backplane Board

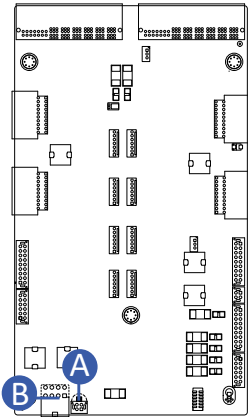

Power Distribution Board

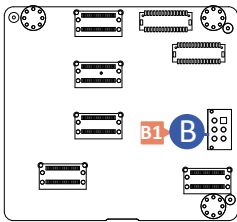

HDD0 ~ HDD3

HDD Backplane Board#1

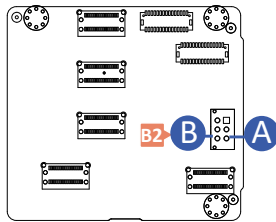

HDD4 ~ HDD7

HDD Backplane Board#2

A	ATX Power Cable (2x2)	HDD Backplane Board#2	BPB_PWR1	
		Power Distribution Board	BPB_PWR2	
B	ATX Power Cable (2x4)	HDD Backplane Board#1	BPB_PWR(B1)	Power Cable (2X3)
		HDD Backplane Board#2	BPB_PWR(B2)	Power Cable (2X1)
		Power Distribution Board	BPB_PWR1	

System Fan Power Cable

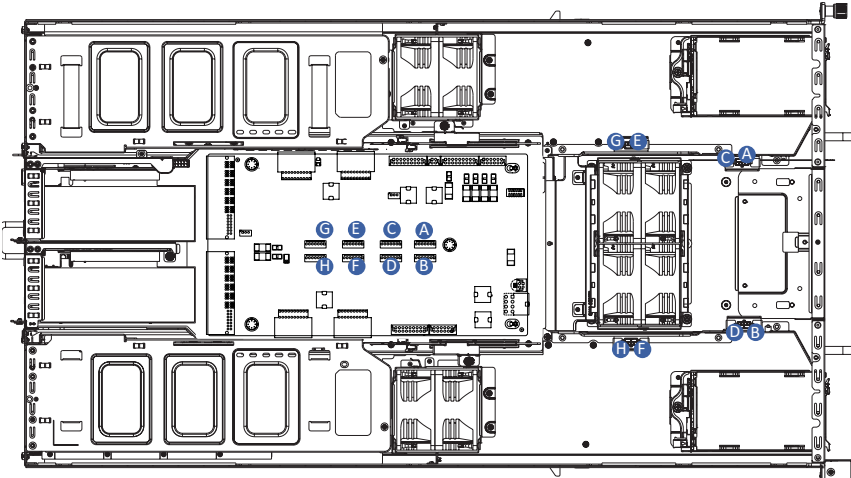

Chapter 4 Motherboard Components

4-1 Motherboard Components

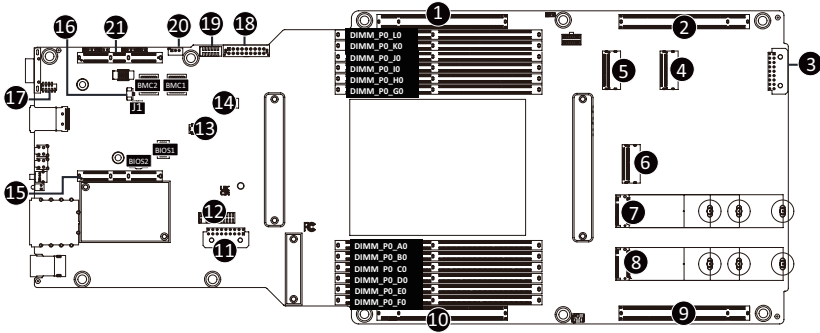

Item	Description
1	PCIe x16 Slot #1
2	PCIe x16 Slot #3
3	2 x 9 Pin Power Connector
4	MCIO Connector (P0_G3_S/SATA)
5	MCIO Connector (P0_G3_U/PCIe Gen5)
6	MCIO Connector (P0_G1/PCIe Gen5)
7	M.2 Slot(M2_0/PCIe Gen5)
8	M.2 Slot(M2_1/PCIe Gen5)
9	PCIe x16 Slot #4
10	PCIe x16 Slot #2
11	2 x 9 Pin Power Connector
12	Front Pnel Header (primary)
13	HDD Back Plane Board Connector
14	TPM Module Connector
15	Proprietaey PCIe Slot(Gen5 x16)
16	System Battery Cable Connector
17	Serial Port Cable Connector
18	2 x 9 Pin Power Connector
19	Front Panel Header (secondary/for power distribution board)
20	12V Standby Power Connector
21	Proprietaey PCIe Slot(Gen5 x16)

4-2 Jumper Setting

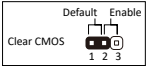

J1		ON	OFF
1	HSMB_SEL	BIOS Defined	
2	PMBUS_SEL	BIOS Defined	
3	BIOS_PWD	Clear supervisor password	Normal [Default]
4	BIOS_RECOVERY	BIOS recovery mode	Normal [Default]

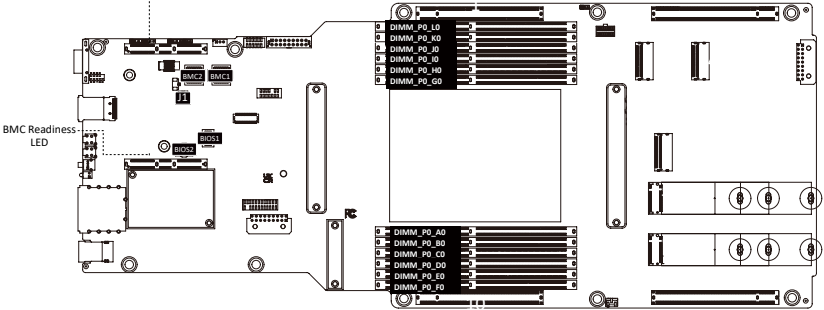

4-3 Backplane Board Storage Connector

4-3-1 CBPE640

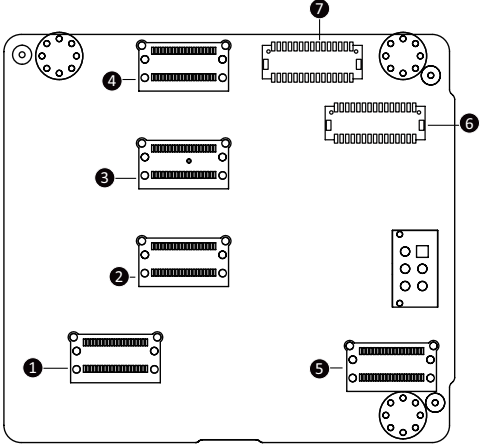

Item	Description
1	MCIO Connector (U2_3)
2	MCIO Connector (U2_2)
3	MCIO Connector (U2_1)
4	MCIO Connector (U2_0)
5	MCIO Connector (SL_CN1)
6	BP_SERIES
7	BP_1

Chapter 5 BIOS Setup

BIOS (Basic Input and Output System) records hardware parameters of the system in the EFI on the motherboard. Its major functions include conducting the Power-On Self-Test (POST) during system startup, saving system parameters, loading the operating system etc. The BIOS includes a BIOS Setup program that allows the user to modify basic system configuration settings or to activate certain system features. When the power is turned off, the battery on the motherboard supplies the necessary power to the CMOS to keep the configuration values in the CMOS.

To access the BIOS Setup program, press the key during the POST when the power is turned on.



- BIOS flashing is potentially risky, if you do not encounter any problems when using the current BIOS version, it is recommended that you don't flash the BIOS. To flash the BIOS, do it with caution. Inadequate BIOS flashing may result in system malfunction.
- It is recommended that you not alter the default settings (unless you need to) to prevent system instability or other unexpected results. Inadequately altering the settings may result in system's failure to boot. If this occurs, try to clear the CMOS values and reset the board to default values. (Refer to the **Exit** section in this chapter or introductions of the battery/clearing CMOS jumper in Chapter 4 for how to clear the CMOS values.)

BIOS Setup Program Function Keys

<<-><->>	Move the selection bar to select the screen
<↑><↓>	Move the selection bar to select an item
<+>	Increase the numeric value or make changes
<->	Decrease the numeric value or make changes
<Enter>	Execute command or enter the submenu
<Esc>	Main Menu: Exit the BIOS Setup program Submenus: Exit current submenu
<F1>	Show descriptions of general help
<F3>	Restore the previous BIOS settings for the current submenus
<F9>	Load the Optimized BIOS default settings for the current submenus
<F10>	Save all the changes and exit the BIOS Setup program

■ **Main**

This setup page includes all the items of the standard compatible BIOS.

■ **Advanced**

This setup page includes all the items of AMI BIOS special enhanced features.

(ex: Auto detect fan and temperature status, automatically configure hard disk parameters.)

■ **AMD CBS**

This setup page includes the common items for configuration of AMD motherboard-related information.

■ **AMD PBS Option**

This setup page includes the common items for configuration of AMD CPM RAS related settings.

■ **Chipset**

This setup page includes all the submenu options for configuring the functions of the North Bridge.

■ **Server Management**

Server additional features enabled/disabled setup menus.

■ **Security**

Change, set, or disable supervisor and user password. Configuration supervisor password allows you to restrict access to the system and BIOS Setup.

A supervisor password allows you to make changes in BIOS Setup.

A user password only allows you to view the BIOS settings but not to make changes.

■ **Boot**

This setup page provides items for configuration of the boot sequence.

■ **Save & Exit**

Save all the changes made in the BIOS Setup program to the CMOS and exit BIOS Setup. (Pressing <F10> can also carry out this task.)

Abandon all changes and the previous settings remain in effect. Pressing <Y> to the confirmation message will exit BIOS Setup. (Pressing <Esc> can also carry out this task.)

5-1 The Main Menu

Once you enter the BIOS Setup program, the Main Menu (as shown below) appears on the screen. Use arrow keys to move among the items and press <Enter> to accept or enter other sub-menu.

Main Menu Help

The on-screen description of a highlighted setup option is displayed on the bottom line of the Main Menu.

Submenu Help

While in a submenu, press <F1> to display a help screen (General Help) of function keys available for the menu. Press <Esc> to exit the help screen. Help for each item is in the Item Help block on the right side of the submenu.



- When the system is not stable as usual, select the **Restore Defaults** item to set your system to its defaults.
- The BIOS Setup menus described in this chapter are for reference only and may differ by BIOS version.

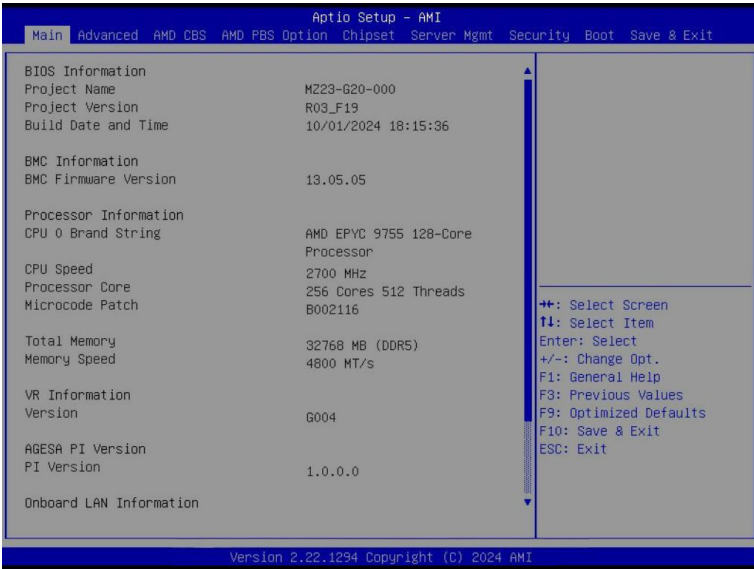

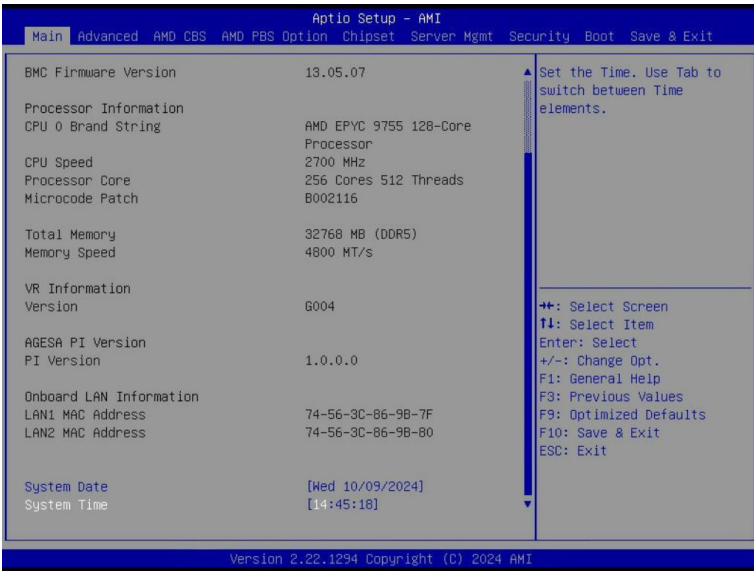

Parameter	Description
BIOS Information	
Project Name	Displays the project name information.
Project Version	Displays version number of the BIOS setup utility.
Build Date and Time	Displays the date and time when the BIOS setup utility was created.
BMC Information ^(Note1)	
BMC Firmware Version ^(Note1)	Displays BMC firmware version information.
Processor Information	
CPU Brand String / CPU Speed / Processor Core / Microcode Patch	Displays the technical specifications for the installed processor(s).
Total Memory ^(Note2)	Displays the total memory size of the installed memory.
Memory Speed ^(Note2)	Displays the frequency information of the installed memory.
VR Information Version	Displays VR version information.
AGESA PI Version	
PI Version	Displays AGESA PI version information.

(Note1) Functions available on selected models.

(Note2) This section will display capacity and frequency information of the memory that the customer has installed.

Parameter	Description
Onboard LAN Information	
LAN1/LAN2 MAC Address ^(Note)	Displays LAN MAC address information.
System Date	Sets the date following the weekday-month-day-year format.
System Time	Sets the system time following the hour-minute-second format.

(Note) The number of LAN ports listed will depend on the motherboard / system model.

5-2 Advanced Menu

The Advanced Menu displays submenu options for configuring the function of various hardware components. Select a submenu item, then press <Enter> to access the related submenu screen.

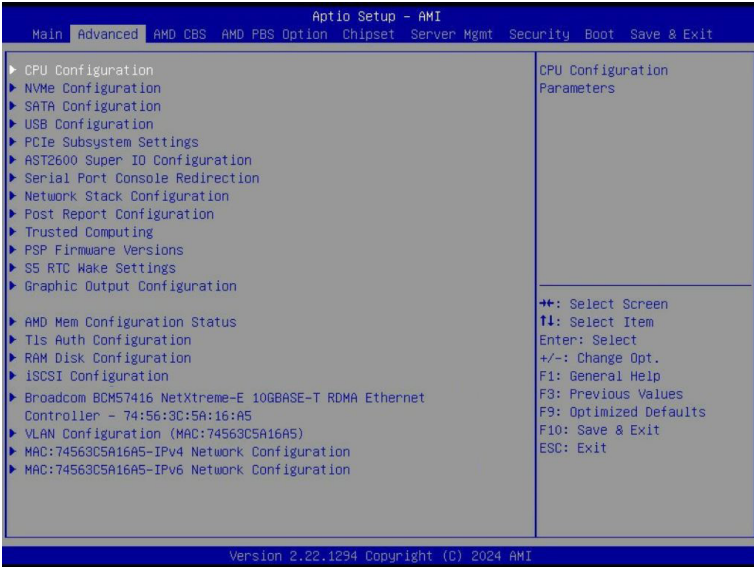

When "Boot Mode Select" is set to Legacy in the Boot > Boot Mode Select section

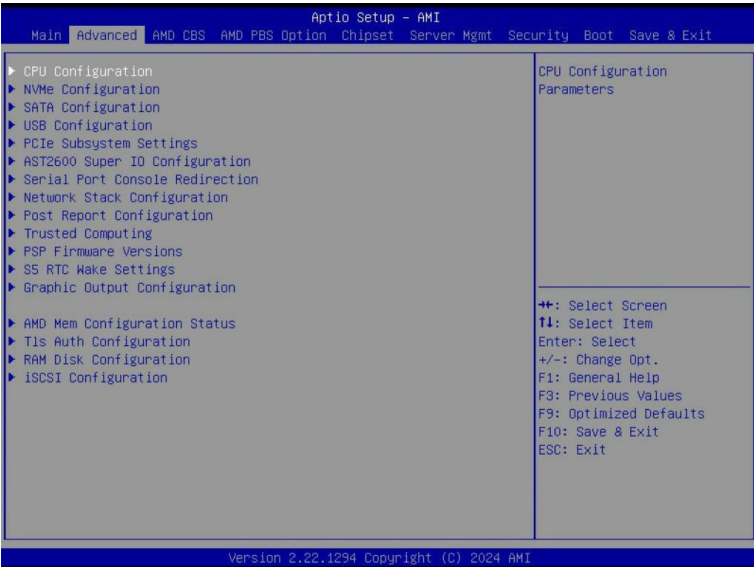

5-2-1 CPU Configuration

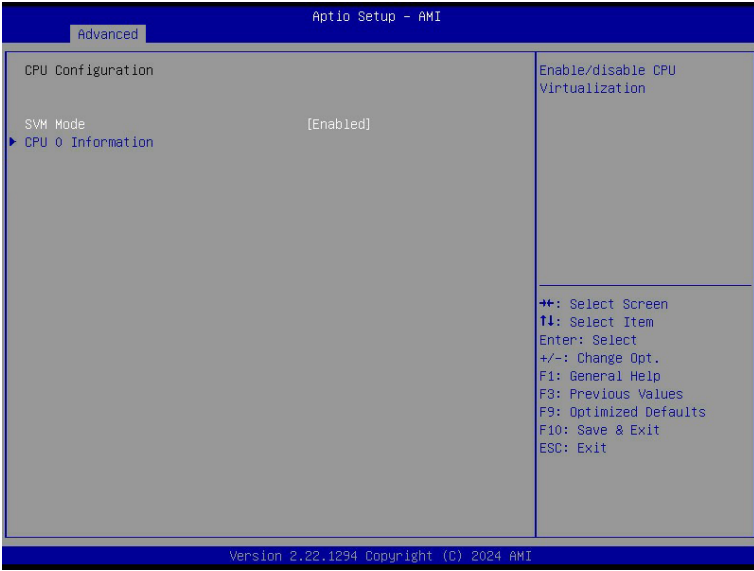

Parameter	Description
SVM Mode	Enable/Disable the CPU Virtualization. Options available: Disabled, Enabled. Default setting is Enabled .
CPU 0 Information	Press [Enter] to view the memory information related to CPU 0.

5-2-2 NVMe Configuration

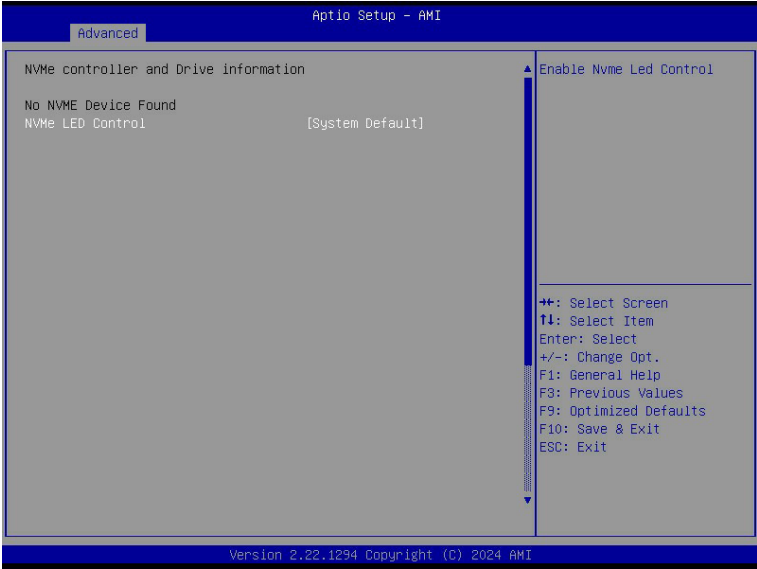

Parameter	Description
NVMe Configuration	Displays the NVMe devices connected to the system.
NVMe LED Control	Enable/Disable NVMe LED Control. Options available: System Default, Disabled, Enabled. Default setting is System Default .

5-2-3 SATA Configuration



Parameter	Description
SATA Configuration	Displays the installed HDD devices information. System will automatically detect HDD type.

5-2-4 USB Configuration

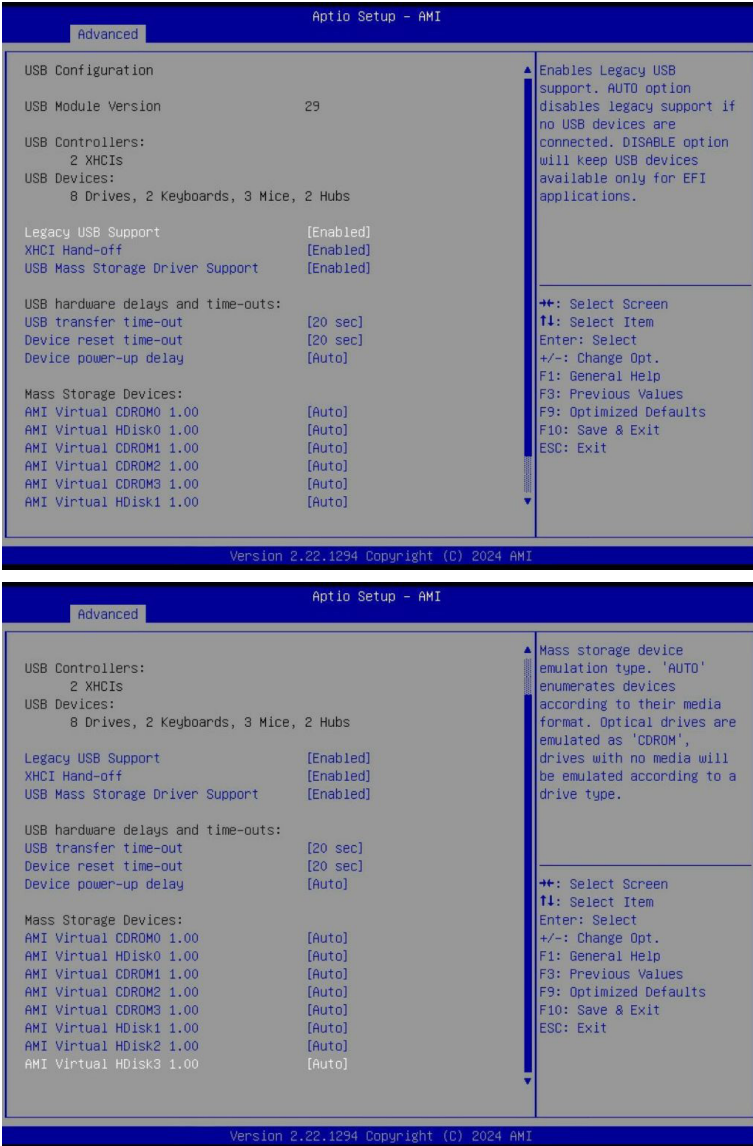

(Note) This item is present only if you attach USB devices.

Parameter	Description
USB Configuration	
USB Module Version	Displays the USB module version information.
USB Controllers	Displays the supported USB controllers.
USB Devices:	Displays the USB devices connected to the system.
Legacy USB Support	Enable/Disable the Legacy USB support function. AUTO option disables legacy support if no USB devices are connected. DISABLE option will keep USB devices available only for EFI applications. Options available: Enabled, Disabled, Auto. Default setting is Enabled .
XHCI Hand-off	Enable/Disable the XHCI Hand-off support. Options available: Enabled, Disabled. Default setting is Enabled .
USB Mass Storage Driver Support ^(Note)	Enable/Disable the USB Mass Storage Driver Support. Options available: Disabled, Enabled. Default setting is Enabled .
USB hardware delays and time-outs	
USB transfer time-out	Selects the time-out value for USB Control/Bulk/Interrupt transfers. Options available: 1 sec, 5 sec, 10 sec, 20 sec. Default setting is 20 sec .
Device reset time-out	Selects the time-out value during a USB mass storage device reset. Options available: 10 sec, 20 sec, 30 sec, 40 sec. Default setting is 20 sec .
Device power-up delay	Maximum time the device will take before it properly reports itself to the Host Controller. "Auto" uses default value: for a Root port it is 100 ms, for a Hub port the delay is taken from Hub descriptor. Options available: Auto, Manual. Default setting is Auto .
Mass Storage Devices	Displays the mass storage devices available on the system.

5-2-5 PCI Subsystem Settings

Aptio Setup - AMI

Advanced

PCI Bus Driver Version	A5.01.28	▲ Change GEN2_1 PCIe lanes.
GEN2_1	[Auto]	
GEN2_1 I/O ROM	[Enabled]	
GEN2_1 Link Speed	[Auto]	
GEN2_2	[Auto]	
GEN2_2 I/O ROM	[Enabled]	
GEN2_2 Link Speed	[Auto]	
PCIe_1	[Auto]	
PCIe_1 I/O ROM	[Enabled]	
PCIe_1 Link Speed	[Auto]	
PCIe_2	[Auto]	
PCIe_2 I/O ROM	[Enabled]	
PCIe_2 Link Speed	[Auto]	
PCIe_3	[Auto]	
PCIe_3 I/O ROM	[Enabled]	
PCIe_3 Link Speed	[Auto]	
PCIe_4	[Auto]	
PCIe_4 I/O ROM	[Enabled]	
PCIe_4 Link Speed	[Auto]	

▲ Select Screen
 T1: Select Item
 Enter: Select
 +/-: Change Opt.
 F1: General Help
 F3: Previous Values
 F9: Optimized Defaults
 F10: Save & Exit
 ESC: Exit

Version 2.22.1294 Copyright (C) 2024 AMI

Aptio Setup - AMI

Advanced

PCIe_1	[Auto]	▲ Enables or Disables PCI Express Device Relaxed Ordering.
PCIe_1 I/O ROM	[Enabled]	
PCIe_1 Link Speed	[Auto]	
PCIe_2	[Auto]	
PCIe_2 I/O ROM	[Enabled]	
PCIe_2 Link Speed	[Auto]	
PCIe_3	[Auto]	
PCIe_3 I/O ROM	[Enabled]	
PCIe_3 Link Speed	[Auto]	
PCIe_4	[Auto]	
PCIe_4 I/O ROM	[Enabled]	
PCIe_4 Link Speed	[Auto]	
Onboard LAN Controller	[Enabled]	
Onboard LAN1 I/O ROM	[Enabled]	
Onboard LAN2 I/O ROM	[Enabled]	
PCI Devices Common Settings:		
Above 4G Decoding	[Enabled]	
SR-IOV Support	[Enabled]	
Relaxed Ordering	[Enabled]	

▲ Select Screen
 T1: Select Item
 Enter: Select
 +/-: Change Opt.
 F1: General Help
 F3: Previous Values
 F9: Optimized Defaults
 F10: Save & Exit
 ESC: Exit

Version 2.22.1294 Copyright (C) 2024 AMI

Parameter	Description
PCI Bus Driver Version	Displays the PCI Bus Driver version information.
U2_P0_P0/2, U2_P1_P0/1/2/3 OCP# Lanes ^(Note1)	Change PCIe lanes. Options available: Disabled, Auto, x16, x8x8, x8x4x4, x4x4x8, x4x4x4x4. Default setting is Auto .
U2_P0_P0/2, U2_P1_P0/1/2/3 OCP# I/O ROM ^(Note1)	When enabled, this setting will initialize the device expansion ROM for the related devices. Options available: Disabled, Enabled. Default setting is Enabled .
U2_P0_P0/2, U2_P1_P0/1/2/3 OCP# Link Speed ^(Note1)	Configure MCIO slot max link speed. Options available: Auto, Gen5, Gen4, Gen3, Gen2, Gen1. Default setting is Auto .
Onboard LAN Controller ^(Note2)	Enable/Disable the onboard LAN devices. Options available: Disabled, Enabled. Default setting is Enabled .
Onboard LAN# I/O ROM ^(Note2)	Enable/Disable the onboard LAN devices, and initializes device expansion ROM. Options available: Disabled, Enabled. Default setting is Enabled .

(Note1) This section is dependent on the available MCIO/OCP connector.

(Note2) This section is dependent on the available LAN controller.

5-2-6 AST2600 Super IO Configuration

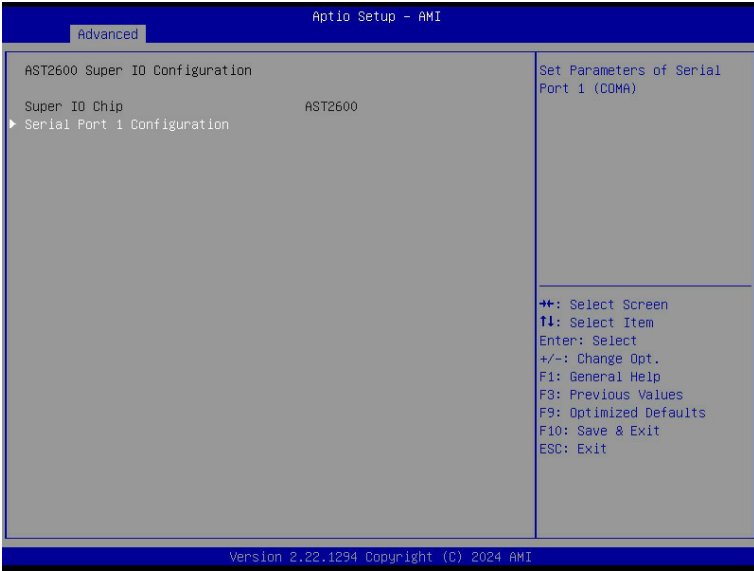

Parameter	Description
AST2600 Super IO Configuration	
Super IO Chip	Displays the super IO chip information
Serial Port 1 Configuration	Press [Enter] for configuration of advanced items.

5-2-6-1 Serial Port 1 Configuration

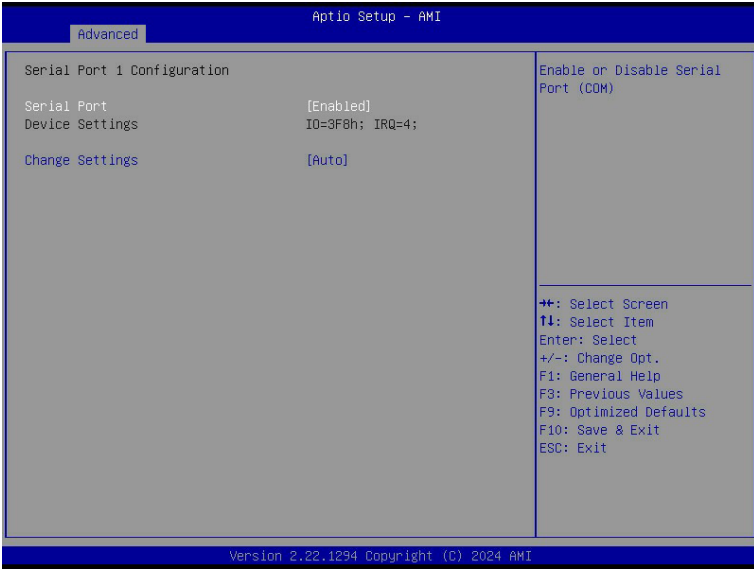

Parameter	Description
Serial Port 1 Configuration	
Serial Port ^(Note)	Enable/Disable the Serial Port (COM). When set to Enabled allows you to configure the Serial port 1 settings. When set to Disabled, displays no configuration for the serial port. Options available: Disabled, Enabled. Default setting is Enabled .
Devices Settings	Displays the Serial Port 1 device settings.
Change Settings	Select an optimal settings for Super IO Device. Options available for Serial Port 1: Auto IO=3F8h; IRQ=4; IO=3F8h; IRQ=3, 4, 5, 6, 7, 9, 10, 11, 12; IO=2F8h; IRQ=3, 4, 5, 6, 7, 9, 10, 11, 12; IO=3E8h; IRQ=3, 4, 5, 6, 7, 9, 10, 11, 12; IO=2E8h; IRQ=3, 4, 5, 6, 7, 9, 10, 11, 12; Default setting is Auto .

(Note) Advanced items prompt when this item is defined.

5-2-7 Serial Port Console Redirection

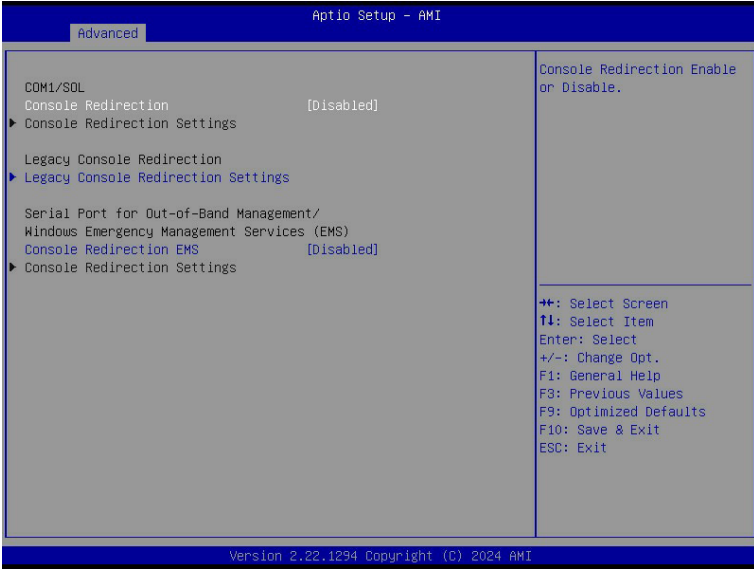

Parameter	Description
COM1/Serial Over LAN Console Redirection ^(Note)	Select whether to enable console redirection for specified device. Console redirection enables the users to manage the system from a remote location. Options available: Enabled, Disabled. Default setting is Disabled .
COM1/Serial Over LAN Console Redirection Settings	Press [Enter] to configure advanced items. Please note that this item is configurable when COM1/Serial Over LAN Console Redirection is set to Enabled. <ul style="list-style-type: none"> ◆ Terminal Type <ul style="list-style-type: none"> – Selects a terminal type to be used for console redirection. – Options available: VT100, VT100Plus, ANSI, VT-UTF8. Default setting is VT100Plus. ◆ Bits per second <ul style="list-style-type: none"> – Selects the transfer rate for console redirection. – Options available: 9600, 19200, 38400, 57600, 115200. Default setting is 115200. ◆ Data Bits <ul style="list-style-type: none"> – Selects the number of data bits used for console redirection. – Options available: 7, 8. Default setting is 8.

(Note) Advanced items prompt when this item is defined.

Parameter	Description
COM1/Serial Over LAN Console Redirection Settings (continued)	<ul style="list-style-type: none"> ◆ Parity <ul style="list-style-type: none"> – A parity bit can be sent with the data bits to detect some transmission errors. – Even: parity bit is 0 if the num of 1's in the data bits is even. – Odd: parity bit is 0 if num of 1's in the data bits is odd. – Mark: parity bit is always 1. Space: Parity bit is always 0. – Mark and Space Parity do not allow for error detection. – Options available: None, Even, Odd, Mark, Space. Default setting is None. ◆ Stop Bits <ul style="list-style-type: none"> – Stop bits indicate the end of a serial data packet. (A start bit indicates the beginning). The standard setting is 1 stop bit. Communication with slow devices may require more than 1 stop bit. – Options available: 1, 2. Default setting is 1. ◆ Flow Control <ul style="list-style-type: none"> – Flow control can prevent data loss from buffer overflow. When sending data, if the receiving buffers are full, a 'stop' signal can be sent to stop the data flow. Once the buffers are empty, a 'start' signal can be sent to re-start the flow. Hardware flow control uses two wires to send start/stop signals. – Options available: None, Hardware RTS/CTS. Default setting is None. ◆ VT-UTF8 Combo Key Support <ul style="list-style-type: none"> – Enable/Disable the VT-UTF8 Combo Key Support. – Options available: Enabled, Disabled. Default setting is Enabled. ◆ Recorder Mode <ul style="list-style-type: none"> – When this mode enabled, only texts will be send. This is to capture Terminal data. – Options available: Enabled, Disabled. Default setting is Disabled. ◆ Resolution 100x31 <ul style="list-style-type: none"> – Enable/Disable extended terminal resolution. – Options available: Enabled, Disabled. Default setting is Enabled. ◆ Putty KeyPad <ul style="list-style-type: none"> – Selects Function Key and KeyPad on Putty. – Options available: VT100, LINUX, XTERMR6, SC0, ESCN, VT400. Default setting is VT100.

Parameter	Description
Legacy Console Redirection	
Legacy Console Redirection Settings	<p>Press [Enter] to configure advanced items.</p> <ul style="list-style-type: none"> ◆ Redirection COM Port <ul style="list-style-type: none"> – Selects a COM port for Legacy serial redirection. – Default setting is COM1/SOL. ◆ Resolution <ul style="list-style-type: none"> – Selects the number of rows and columns used in Console Redirection for legacy OS support. – Options available: 80x24, 80x25. Default setting is 80x24. ◆ Redirect After POST <ul style="list-style-type: none"> – When Bootloader is selected, then Legacy Console Redirection is disabled before booting to legacy OS. When Always Enable is selected, then Legacy Console Redirection is enabled for legacy OS. – Options available: Always Enable, BootLoader. Default setting is Always Enable.
Serial Port for Out-of-Band Management / Windows Emergency Management Services (EMS) Console Redirection ^(Note)	<p>EMS console redirection allows the user to configure Console Redirection Settings to support Out-of-Band Serial Port management.</p> <p>Options available: Disabled, Enabled. Default setting is Disabled.</p>
Serial Port for Out-of-Band EMS Console Redirection Settings	<p>Press [Enter] to configure advanced items.</p> <p>Please note that this item is configurable when Serial Port for Out-of-Band Management EMS Console Redirection is set to Enabled.</p> <ul style="list-style-type: none"> ◆ Out-of-Band Mgmt Port <ul style="list-style-type: none"> – Microsoft Windows Emergency Management Service (EMS) allows for remote management of a Windows Server OS through a serial port. – Default setting is COM1/SOL. ◆ Terminal Type <ul style="list-style-type: none"> – Selects a terminal type to be used for console redirection. – Options available: VT100, VT100Plus, ANSI, VT-UTF8. Default setting is ANSI. ◆ Bits per second <ul style="list-style-type: none"> – Selects the transfer rate for console redirection. – Options available: 9600, 19200, 57600, 115200. Default setting is 115200.

(Note) Advanced items prompt when this item is defined.

Parameter	Description
Serial Port for Out-of-Band EMS Console Redirection Settings(continued)	<ul style="list-style-type: none">◆ Flow Control<ul style="list-style-type: none">– Flow control can prevent data loss from buffer overflow. When sending data, if the receiving buffers are full, a 'stop' signal can be sent to stop the data flow. Once the buffers are empty, a 'start' signal can be sent to re-start the flow. Hardware flow control uses two wires to send start/stop signals.– Options available: None, Hardware RTS/CTS, Software Xon/Xoff. Default setting is None.

5-2-8 Network Stack Configuration

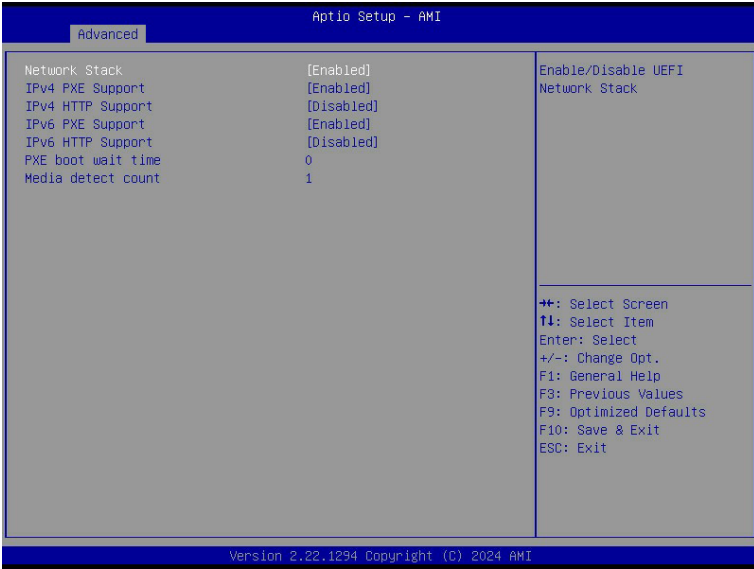

Parameter	Description
Network Stack	Enable/Disable the UEFI network stack. Options available: Enabled, Disabled. Default setting is Enabled .
Ipv4 PXE Support ^(Note)	Enable/Disable the Ipv4 PXE feature. Options available: Enabled, Disabled. Default setting is Enabled .
Ipv4 HTTP Support ^(Note)	Enable/Disable the Ipv4 HTTP feature. Options available: Enabled, Disabled. Default setting is Disabled .
Ipv6 PXE Support ^(Note)	Enable/Disable the Ipv6 PXE feature. Options available: Enabled, Disabled. Default setting is Enabled .
Ipv6 HTTP Support ^(Note)	Enable/Disable the Ipv6 HTTP feature. Options available: Enabled, Disabled. Default setting is Disabled .
PXE boot wait time ^(Note)	Wait time in seconds to press ESC key to abort the PXE boot. Press the <+> / <-> keys to increase or decrease the desired values.
Media detect count ^(Note)	Number of times the presence of media will be checked. Press the <+> / <-> keys to increase or decrease the desired values.

(Note) This item appears when **Network Stack** is set to **Enabled**.

5-2-9 Post Report Configuration

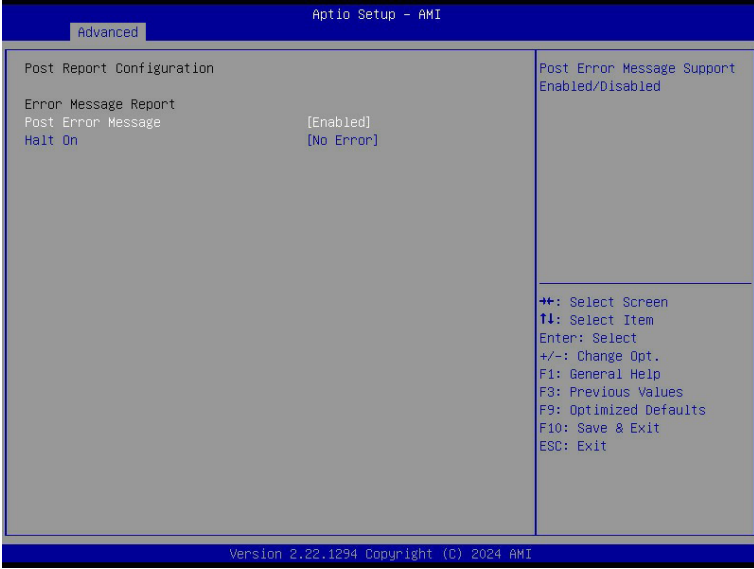

Parameter	Description
Post Report Configuration	
Error Message Report	
Post Error Message	Enable/Disable the POST Error Message support. Options available: Enabled, Disabled. Default setting is Enabled .
Halt On	Options available: No Error, All Error. Default setting is No Error .

5-2-10 Trusted Computing

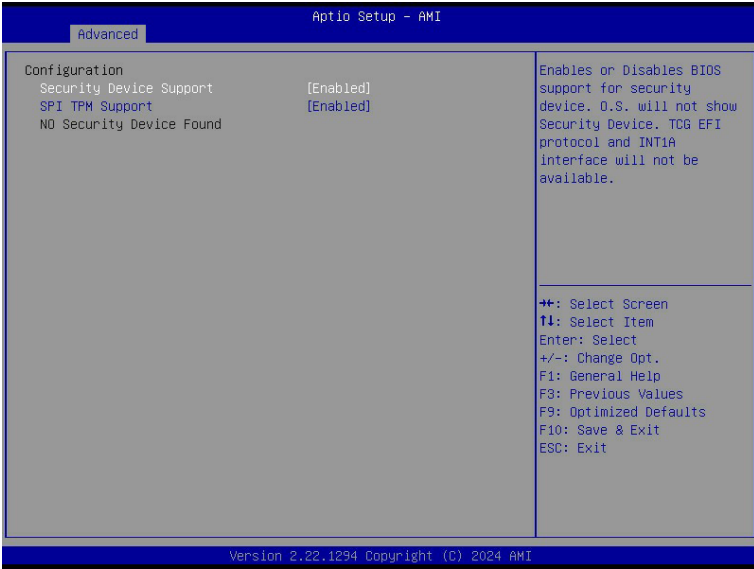

Parameter	Description
Configuration	
Security Device Support	<p>Enable/Disable BIOS support for security device. OS will not show security device. TCG EFI protocol and INT1A interface will not be available.</p> <p>Options available: Disabled, Enabled. Default setting is Enabled.</p>
SPI TPM Support	<p>Select Enable to activate TPM support feature.</p> <p>Options available: Disabled, Enabled. Default setting is Enabled.</p>

5-2-11 PSP Firmware Versions

The PSP Firmware Versions page displays the basic PSP firmware version information. Items on this window are non-configurable.

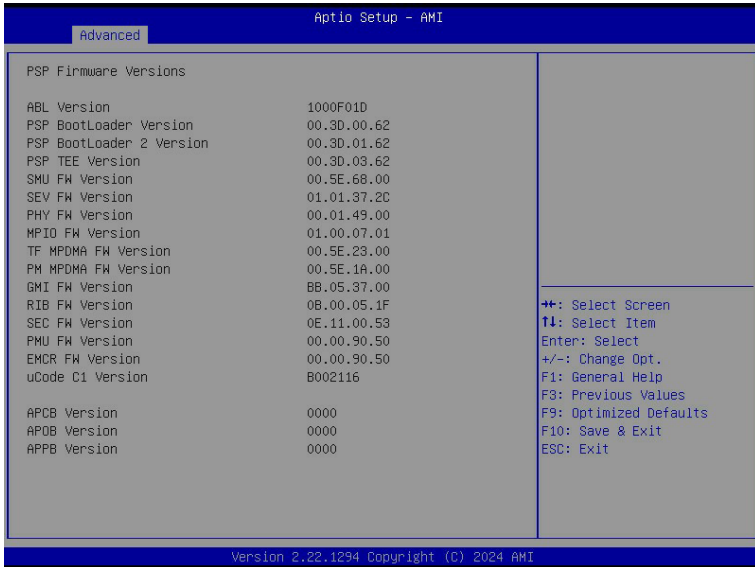

5-2-12 S5 RTC Wake Settings

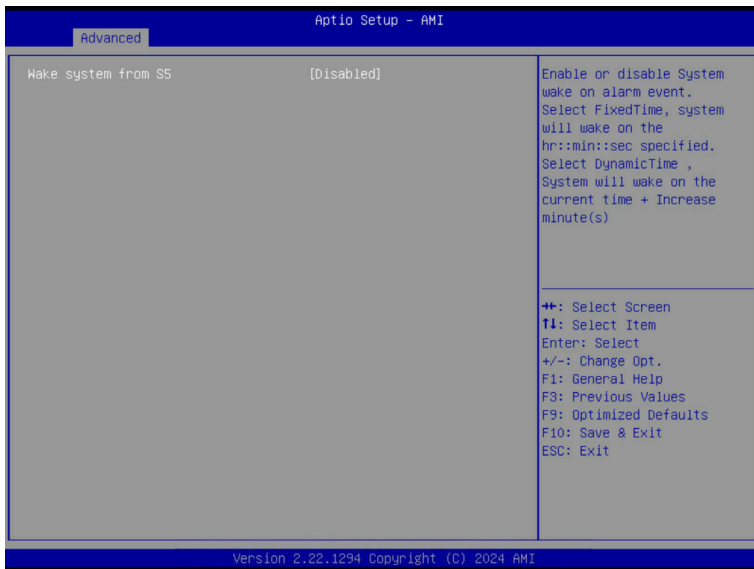

Parameter	Description
Wake System from S5	Enable/Disable system wake on alarm event. Options available: Disabled, Fixed Time, Dynamic Time. When Fixed Time is selected, system will wake on the hr::min::sec specified. Default setting is Disabled .

5-2-13 Graphic Output Configuration



Parameter	Description
Output Device Type	Selects output device type. Options available: First loaded Device, Onboard Device, External Device, Specific Device. Default setting is Onboard Device .

5-2-14 AMD Mem Configuration Status

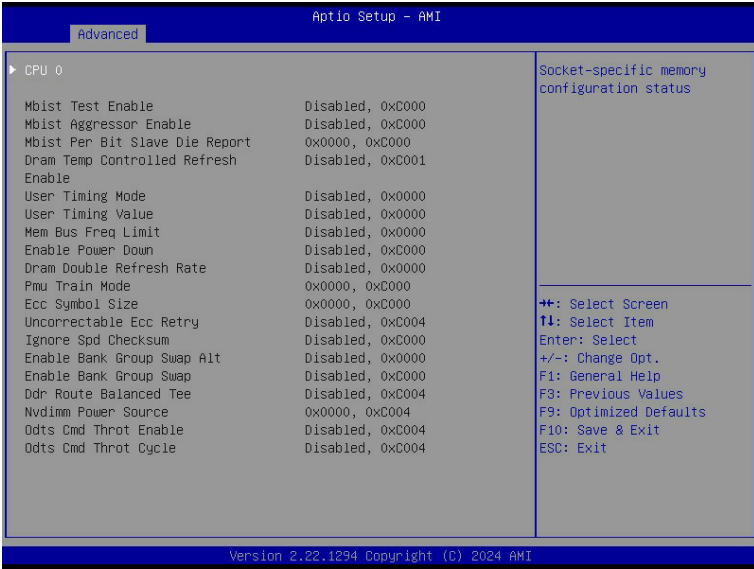

Parameter	Description
CPU 0	Press [Enter] to view the memory configuration status related to CPU 0.

5-2-15 Tls Auth Configuration

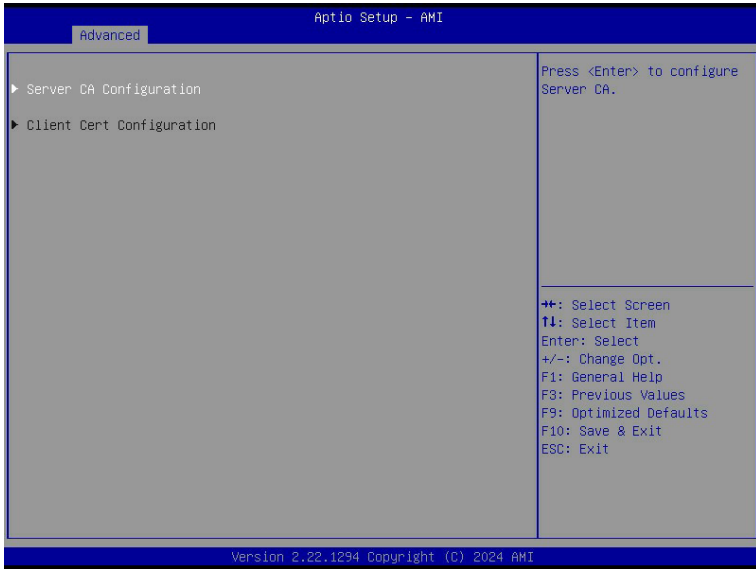

Parameter	Description
Server CA Configuration	<p>Press [Enter] for configuration of advanced items.</p> <ul style="list-style-type: none"> ◆ Enroll Cert <ul style="list-style-type: none"> – Press [Enter] to enroll a certificate <ul style="list-style-type: none"> • Enroll Cert Using File • Cert GUID <p>Input digit character in 1111111-2222-3333-4444-1234567890ab format.</p> <ul style="list-style-type: none"> – Commit Changes and Exit – Discard Changes and Exit <ul style="list-style-type: none"> ◆ Delete Cert
Client Cert Configuration	Press [Enter] for configuration of advanced items.

5-2-16 RAM Disk Configuration

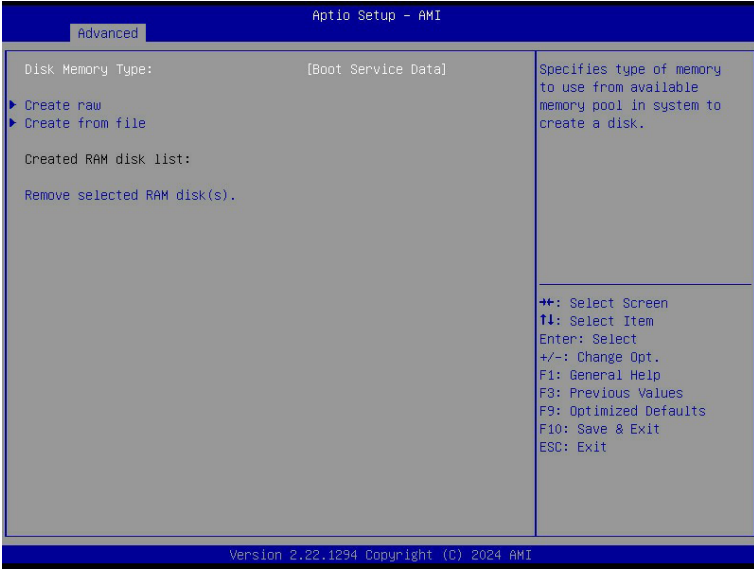

Parameter	Description
Disk Memory Type	Specifies the type of memory to use from available memory pool in system to create a disk. Options available: Boot Service Data, Reserved. Default setting is Boot Service Data .
Create Raw	Creates a raw RAM disk. <ul style="list-style-type: none"> ◆ Size (Hex) <ul style="list-style-type: none"> – Input a valid RAM disk size that should be multiple of the RAM disk block size. ◆ Create & Exit ◆ Discard & Exit
Create from file	Creates a RAM disk from a given file.
Created RAM disk list	
Remove selected RAM disk(s)	Selects the RAM disk(s) to remove.

5-2-17 iSCSI Configuration

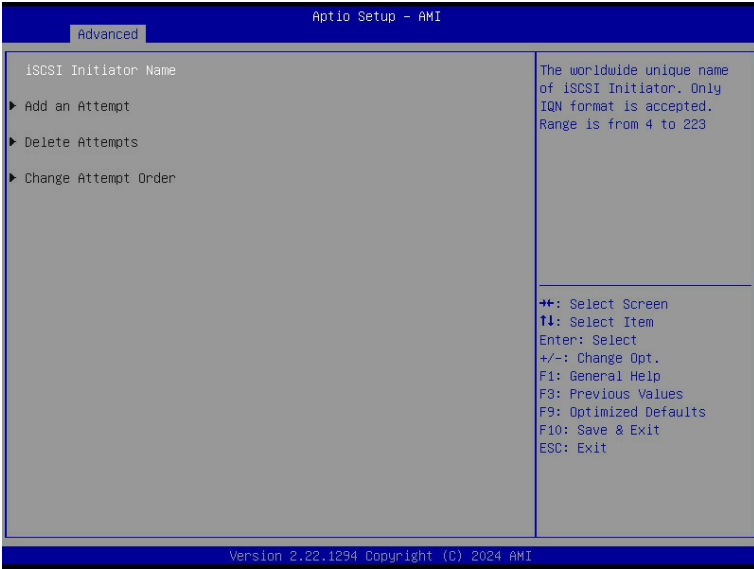

Parameter	Description
iSCSI Initiator Name	Press [Enter] and name iSCSI Initiator. Only IQN format is accepted. Range: from 4 to 223
Add an Attempt	Press [Enter] to configure advanced items.
Delete Attempts	Press [Enter] to configure advanced items.
Change Attempt Order	Press [Enter] to configure advanced items.

5-2-18 Broadcom BCM57416 10GBASE-T Network Connection

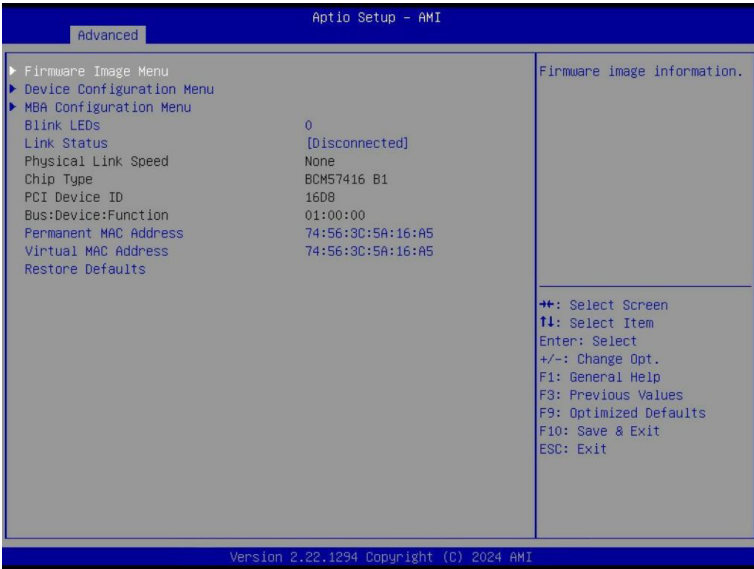

Parameter	Description
Firmware Image Menu	Press [Enter] to view firmware image information.
Device Configuration Menu	<p>Press [Enter] to configure advanced items.</p> <ul style="list-style-type: none"> ◆ Multi-Function Mode <ul style="list-style-type: none"> – Configures the NIC Hardware Mode. – Options available: SF, NPAR 1.0. Default setting is SF. ◆ SR-IOV <ul style="list-style-type: none"> – Enable/Disable Single Root I/O Virtualization. – Options available: Disabled, Enabled. Default setting is Disabled. ◆ Number of MSI-X Vectors per VF <ul style="list-style-type: none"> – Configures the number of MSI-X Vectors per VF (0-128). – Default setting is 16. ◆ Maximum Number of PF MSI-X Vectors <ul style="list-style-type: none"> – Configures the maximum number of PF MSI-X Vectors (0-512 per controller). – Default setting is 74. ◆ Energy Efficient Ethernet <ul style="list-style-type: none"> – Enable/Disable Energy Efficient Ethernet operation. – Options available: Disabled, Enabled. Default setting is Disabled. ◆ Operational Link Speed <ul style="list-style-type: none"> – Configures the link speed setting to be used as the default link speed for the selected port. – Options available: AutoNeg. Default setting is AutoNeg.

Parameter	Description
Device Configuration Menu (continued)	<ul style="list-style-type: none"> ◆ Support RDMA <ul style="list-style-type: none"> – Enable/Disable RDMA support for this port. – Options available: Disabled, Enabled. Default setting is Disabled. ◆ DCB Protocol <ul style="list-style-type: none"> – Enable/Disable DCB protocol. – Options available: Disabled, Enabled (IEEE only), CEE (only), Both (IEEE preferred with fallback to CEE). Default setting is Disabled. ◆ LLDP nearest bridge <ul style="list-style-type: none"> – Enable/Disable LLDP nearest bridge state. – Options available: Disabled, Enabled. Default setting is Enabled. ◆ Default EVB Mode <ul style="list-style-type: none"> – Configures the default Edge Virtual Bridging mode. – Options available: VEB, VEPA, None. Default setting is VEB. ◆ Enable PME Capability <ul style="list-style-type: none"> – Enable/Disable PME Capability support. – Options available: Disabled, Enabled. Default setting is Enabled. ◆ Flow Offload <ul style="list-style-type: none"> – Options available: Enabled, Disabled. Default setting is Disabled. ◆ Live Firmware Upgrade <ul style="list-style-type: none"> – Options available: Enabled, Disabled. Default setting is Disabled. ◆ Adapter Error Recovery <ul style="list-style-type: none"> – Options available: Enabled, Disabled. Default setting is Disabled.
MBA Configuration Menu	<p data-bbox="352 801 689 823">Press [Enter] to configure advanced items.</p> <ul style="list-style-type: none"> ◆ Option ROM <ul style="list-style-type: none"> – Enable/Disable Boot Option ROM. – Options available: Disabled, Enabled. Default setting is Enabled. ◆ Legacy Boot Protocol <ul style="list-style-type: none"> – Selects non-UEFI Boot Protocol: Preboot Execution Environment (PXE)/iSCSI. – Options available: PXE, iSCSI, NONE. Default setting is PXE. ◆ Boot Strap Type <ul style="list-style-type: none"> – Selects the boot strap type. Options available: Auto Detect, BBS, Int 18h, Int 19h. Default setting is Auto Detect. ◆ Hide Setup Prompt <ul style="list-style-type: none"> – Configures whether the Setup Prompt is displayed during ROM initialization. – Options available: Disabled, Enabled. Default setting is Disabled. ◆ Setup Key Stroke <ul style="list-style-type: none"> – Configures key strokes to invoke the configuration menu. – Options available: Ctrl-S, Ctrl-B. Default setting is Ctrl-S. ◆ Banner Message Timeout <ul style="list-style-type: none"> – Selects the timeout value. (0 defaults to 4 seconds, 15 is no delay, 1-14 is timeout value in seconds) – Default setting is 5.

Parameter	Description
MBA Configuration Menu (continued)	<ul style="list-style-type: none"> ◆ Pre-boot Wake On LAN <ul style="list-style-type: none"> – Configures Pre-boot Wake on LAN (WOL). – Options available: Disabled, Enabled. Default setting is Enabled. ◆ VLAN Mode <ul style="list-style-type: none"> – Configures the virtual LAN (VLAN) mode. – Options available: Disabled, Enabled. Default setting is Disabled. ◆ VLAN ID <ul style="list-style-type: none"> – Configures the VLAN ID (1...4094). – This item is available only when VLAN Mode is Enabled. ◆ Boot Retry Count <ul style="list-style-type: none"> – Selects the number of boot retries. – Options available: No Retry, 1 Retry, 2 Retries, 3 Retries, 4 Retries, 5 Retries, 6 Retries, Indefinite Retries. Default setting is No Retry.
iSCSI Boot Configuration Menu	Press [Enter] to configure advanced items.
Blink LEDs	Identifies the physical network port by blinking the associated LED. Press the numeric keys to adjust desired values.
Link Status	Specifies the link status of the port.
Physical Link Speed	Displays the technical specifications for the Network Interface Controller.
Chip Type	Displays the technical specifications for the Network Interface Controller.
PCI Device ID	Displays the technical specifications for the Network Interface Controller.
Bus:Device:Function	Displays the technical specifications for the Network Interface Controller.
Permanent MAC Address	Displays the MAC address of the Ethernet controller.
Virtual MAC Address	Displays the virtual MAC address of the Ethernet controller.
Restore Defaults	Resets the adapter to factory defaults.

5-2-19 VLAN Configuration

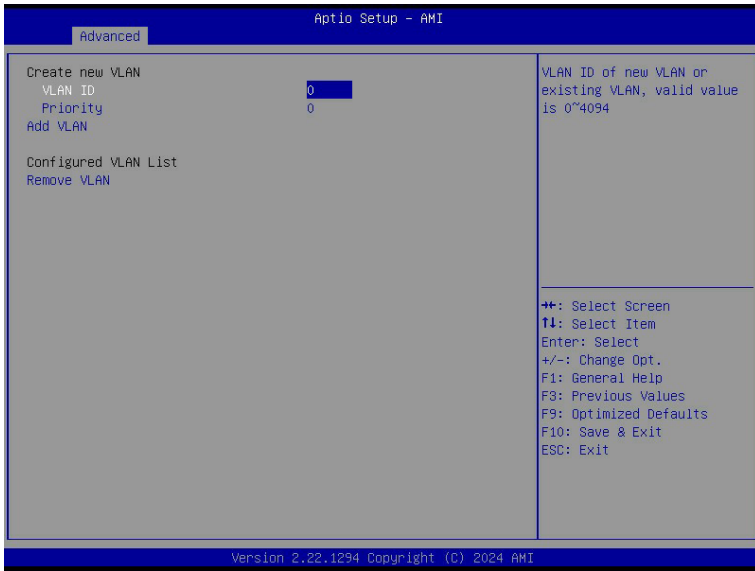

Parameter	Description
Enter Configuration Menu	<p>Press [Enter] to configure advanced items.</p> <ul style="list-style-type: none"> ◆ Create new VLAN ◆ VLAN ID <ul style="list-style-type: none"> – Sets VLAN ID for a new VLAN or an existing VLAN. – Press the <+> / <-> keys to increase or decrease the desired values. – The valid range is from 0 to 4094. ◆ Priority <ul style="list-style-type: none"> – Sets 802.1Q Priority for a new VLAN or an existing VLAN. – Press the <+> / <-> keys to increase or decrease the desired values. – The valid range is from 0 to 7. ◆ Add VLAN <ul style="list-style-type: none"> – Press [Enter] to create a new VLAN or update an existing VLAN. ◆ Configured VLAN List ◆ Remove VLAN <ul style="list-style-type: none"> – Press [Enter] to remove an existing VLAN.

5-2-20 MAC IPv4 Network Configuration

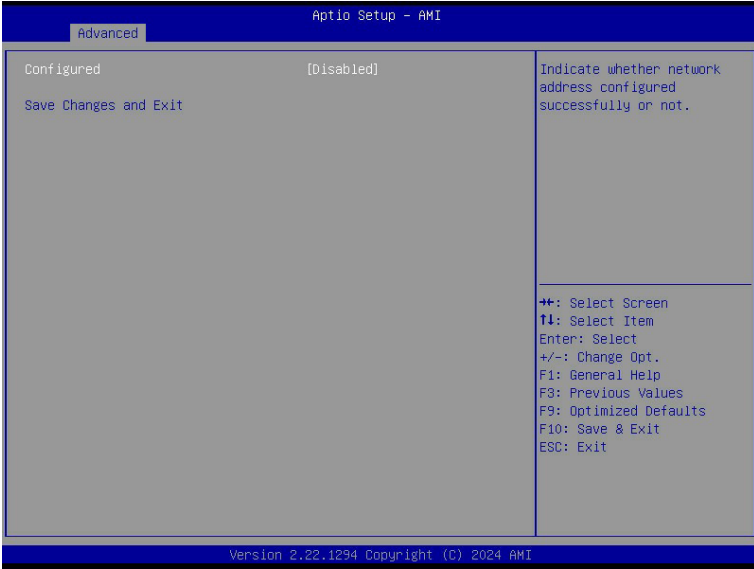

Parameter	Description
Configured	Indicates whether network address is configured successfully or not. Options available: Enabled, Disabled. Default setting is Disabled .
Enable DHCP ^(Note)	Options available: Enabled, Disabled. Default setting is Disabled .
Local IP Address ^(Note)	Press [Enter] to configure local IP address.
Local NetMask ^(Note)	Press [Enter] to configure local NetMask.
Local Gateway ^(Note)	Press [Enter] to configure local Gateway
Local DNS Servers ^(Note)	Press [Enter] to configure local DNS servers
Save Changes and Exit	Press [Enter] to save all configurations.

(Note) This item appears when **Configured** is set to **Enabled**.

5-2-21 MAC IPv6 Network Configuration

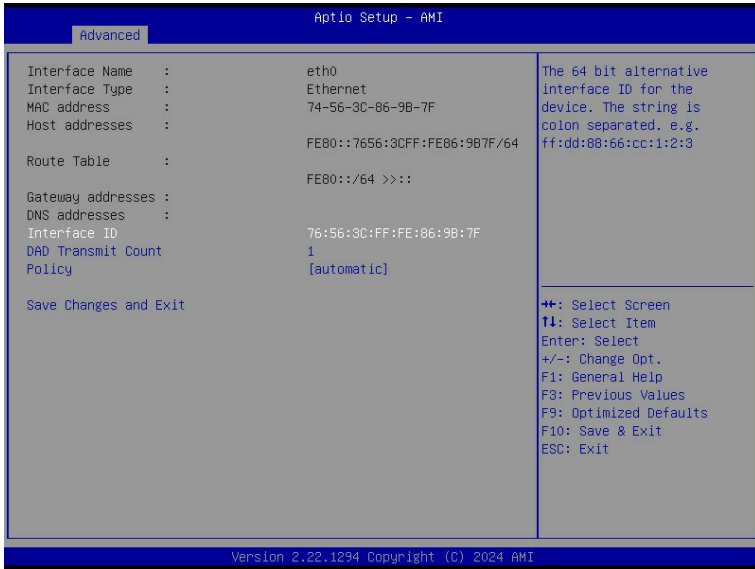

Parameter	Description
Enter Configuration Menu	<p>Press [Enter] to configure advanced items.</p> <ul style="list-style-type: none"> ◆ Displays the MAC Address information. ◆ Interface ID <ul style="list-style-type: none"> – The 64 bit alternative interface ID for the device. The string is colon separated. e.g. ff:dd:88:66:cc:1:2:3. ◆ DAD Transmit Count <ul style="list-style-type: none"> – The number of consecutive Neighbor solicitation messages sent while performing Duplicate Address Detection on a tentative address. A value of zero indicates that Duplicate Address Detection is not performed. ◆ Policy <ul style="list-style-type: none"> – Options available: automatic, manual. Default setting is automatic. ◆ Save Changes and Exit <ul style="list-style-type: none"> – Press [Enter] to save all configurations.

5-3 AMD CBS Menu

AMD CBS menu displays submenu options for configuring the CPU-related information that the BIOS automatically sets. Select a submenu item, then press [Enter] to access the related submenu screen.

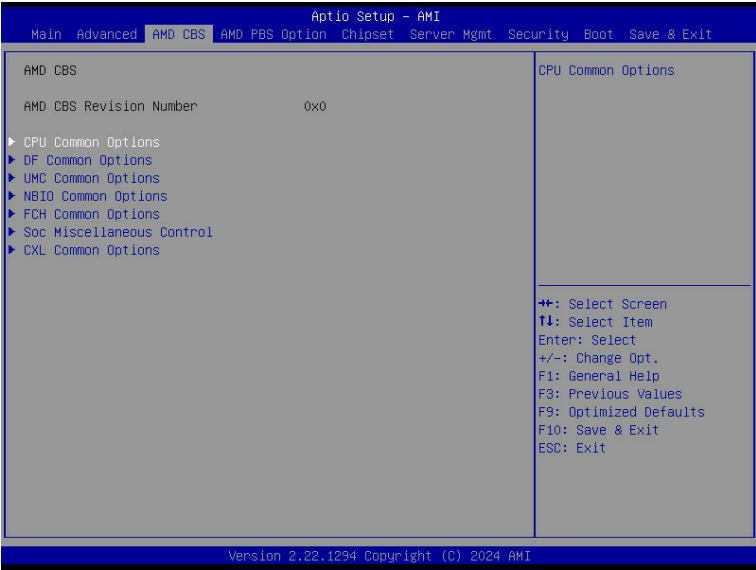

5-3-1 CPU Common Options

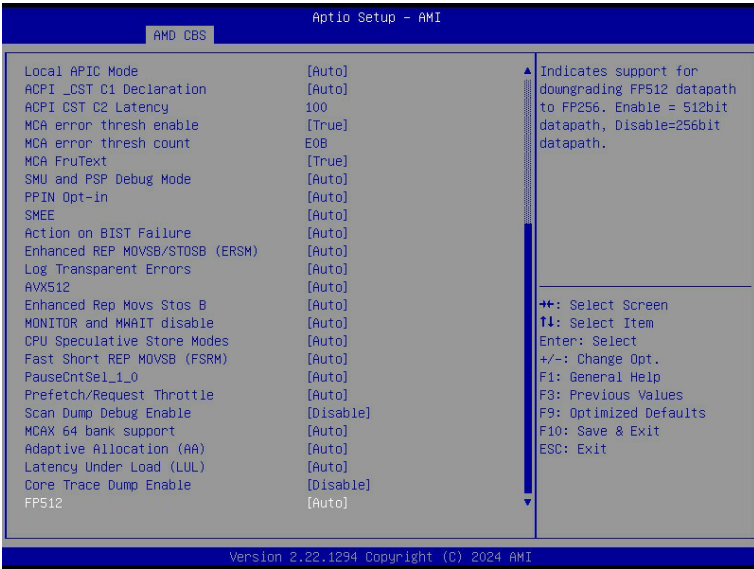
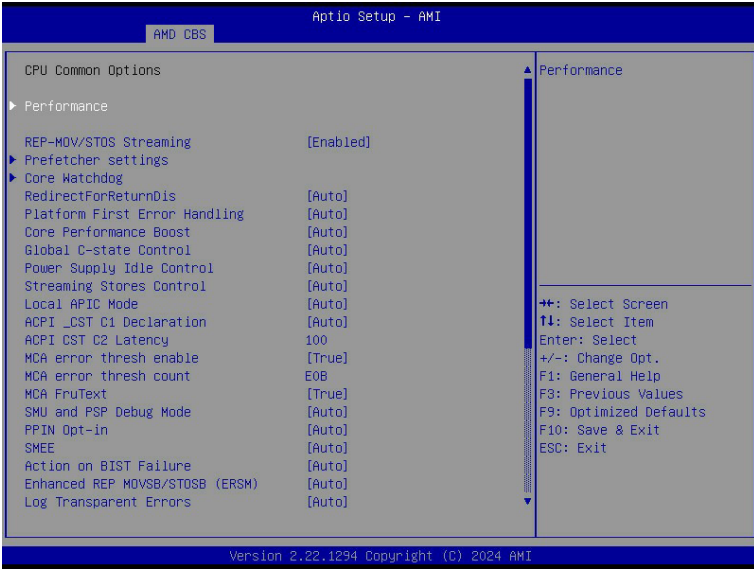

Parameter	Description
CPU Common Options	
Performance	Press [Enter] for configuration of advanced items.
REP-MOV/STOS Streaming	Allow REP-MOV/STOS to use non-caching streaming stores for large sizes. Options available: Disabled, Enabled. Default setting is Enabled .
Prefetcher settings	Press [Enter] for configuration of advanced items.
Core Watchdog	Press [Enter] for configuration of advanced items.
RedirectForReturnDis	From a workaround for GCC/C000005 issue for XV Core on CZ A0, setting MSRC001_1029 Decode Configuration (DE_CFG) bit 14 [DecfgNoRdrctForReturns] to 1. Options available: Auto, 1, 0. Default setting is Auto .
Platform First Error Handling	Enable/Disable PFEH, cloak individual banks, and mask deferred error interrupts from each bank. Options available: Enabled, Disabled, Auto. Default setting is Auto .
Core Performance Boost	Enable/Disable the Core Performance Boost function. Options available: Disabled, Auto. Default setting is Auto .
Global C-state Control	Controls the IO based C-state generation and DF C-states. Options available: Disabled, Enabled, Auto. Default setting is Auto .
Power Supply Idle Control	Configures the Power Supply Idle Control. Options available: Low Current Idle, Typical Current Idle, Auto. Default setting is Auto .
Streaming Stores Control	Enable/Disable the Streaming Stores functionality. Options available: Disabled, Enabled, Auto. Default setting is Auto .
Local APIC Mode	Sets the Local APIC Mode. Options available: Compatibility, xAPIC, x2APIC, Auto. Default setting is Auto .
ACPI_CST C1 Declaration	Determines whether or not to declare the C1 state to the OS.. Options available: Disabled, Enabled, Auto. Default setting is Auto .
ACPI CST C2 Latency	Enter in microseconds (decimal value).
MCA error thresh enable	Enable MCA error thresholding. Options available: False, True, Auto. Default setting is True .
MCA error thresh count	Effective error threshold count = 0xFFFF(4095) - <this value> (e.g. the default value of 0xFF5(4085) results in a threshold of 0xA (10)).
MCA FruText	Enable MCA FruText. Options available: False, True. Default setting is True .
SMU and PSP Debug Mode	When this option is enabled, specific uncorrected errors detected by the PSP FW or SMU FW will hand and not reset the system. Options available: Disabled, Enabled, Auto. Default setting is Auto .
PPIN Opt-in	Enable/Disable the PPIN feature. Options available: Disabled, Enabled, Auto. Default setting is Auto .

Parameter	Description
SMEE	Controls the Secure Memory Encryption Enable (SMEE) function. Options available: Disable, Enable, Auto. Default setting is Auto .
Action on BIST Failure	Action to take when a CCD BIST failure is detected. Options available: Do nothing, Down-CCD, Auto. Default setting is Auto .
Enhanced REP MOVSB/ STOSB (ERSM)	Options available: Disabled, Enabled, Auto. Default setting is Auto .
Log Transparent Errors	Enable/Disable the log Transparent errors function. Options available: Auto, Disabled, Enabled. Default setting is Auto .
AVX512	Enable/Disable AVX512. Options available: Disabled, Enabled, Auto. Default setting is Auto .
Enhanced REP Movs Stos B	Options available: Disabled, Enabled, Auto. Default setting is Auto .
MONITOR and MWAIT disable	The MONITOR, MWAIT, MONITORX and MWAITX opcodes become invalid when enabled. Options available: Enabled, Disabled, Auto. Default setting is Auto
CPU Speculative Store Modes	Select the CPU speculative store modes. Options available: Balanced, More Speculative, Less Speculative, Auto. Default setting is Auto .
Fast Short REP MOVSB (FSRM)	Options available: Disabled, Enabled, Auto. Default setting is Auto .
PauseCntSel_1_0	Options available: Disabled, Enabled, Auto. Default setting is Auto .
Prefetch/Request Throttle	Enables XI logic which calculates average latency, updates throttle level, and sends throttle level messages to L2. Options available: Disable, Enable, Auto. Default setting is Auto .
Scan Dump Debug Enable	Options available: Disable, Enable. Default setting is Disable .
MCAX 64 bank support	Options available: Disabled, Enabled, Auto. Default setting is Auto .
Adaptive Allocation (AA)	Options available: Disabled, Enabled, Auto. Default setting is Auto .
Latency Under Load (LUL)	Options available: Disabled, Enabled, Auto. Default setting is Auto .
Core Trace Dump Enable	Options available: Disable, Enable. Default setting is Disable .
FP512	Options available: Disabled, Enabled, Auto. Default setting is Auto .

5-3-1-1 Performance

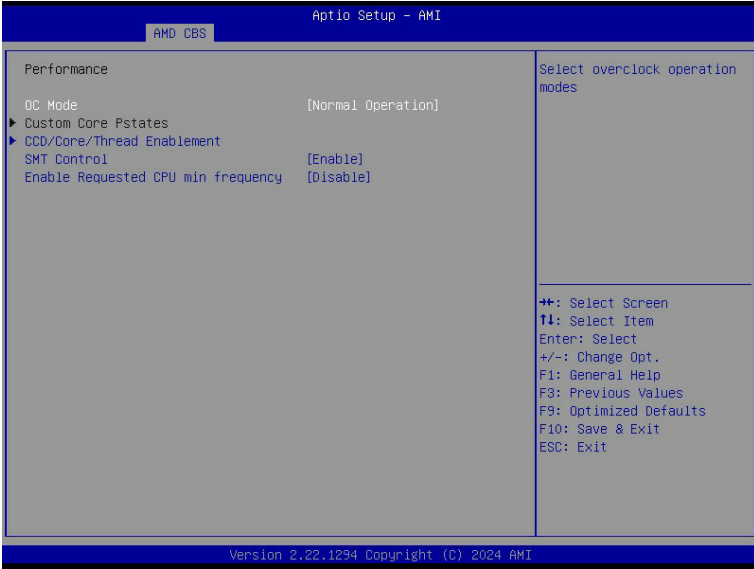

Parameter	Description
Performance	
OC Mode ^(Notes)	Options available: Normal Operation, Customized. Default setting is Normal Operation .
Custom Core Pstates	Allows you to accept or decline enabling Custom Core Pstates. When accepted, you can disable or customize core pstates.
CCD/Core/Thread Enablement	Allows you to accept or decline enabling CCDs, processor cores and threads. When accepted, you can control the number of CCDs to be used, and the number of cores to be used. <ul style="list-style-type: none"> ◆ CCD Control <ul style="list-style-type: none"> – Options available: Auto, 2 CCDs, 4 CCDs, 6 CCDs, 8 CCDs, 10 CCDs. Default setting is Auto. ◆ Core Control <ul style="list-style-type: none"> – Options available: Auto, ONE(1+0), TWO(2+0), THREE(3+0) FOUR(4+0), FIVE(5+0), SIX(6+0), SEVEN(7+0). – Default setting is Auto.
SMT Control	Can be used to disable symmetric multithreading. To re-enable SMT, a POWER CYCLE is needed after select the 'Enable' option. Select 'Auto' base on BIOS PCD. (PcdAmdSmtMode) default setting. Options available: Disable, Enable, Auto. Default setting is Enable .
Enable Requested CPU min frequency	Options available: Disable, Enable, Auto. Default setting is Disable .

(Note) Advanced items are configurable when this item is defined.

5-3-1-2 Prefetcher Settings

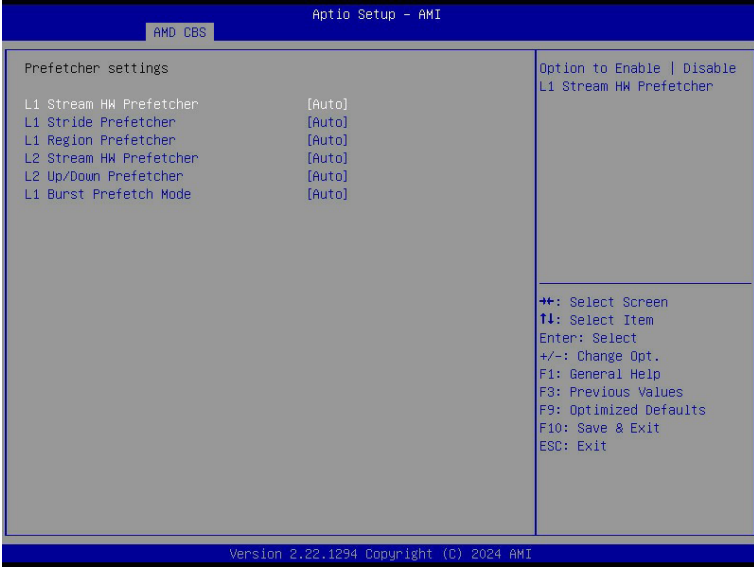

Parameter	Description
Prefetcher settings	
L1 Stream HW Prefetcher	Enable/Disable L1 Stream HW Prefetcher. Options available: Disable, Enable, Auto. Default setting is Auto .
L1 Stride Prefetcher	Use memory access history of individual instructions to fetch additional lines when each access is a constant distance from the previous. Enable/Disable L1 Stride Prefetcher. Options available: Disable, Enable, Auto. Default setting is Auto .
L1 Region Prefetcher	Use memory access history to fetch additional lines when the data access for a given instruction tends to be followed by other data accesses. Enable/Disable L1 Region Prefetcher. Options available: Disable, Enable, Auto. Default setting is Auto .
L2 Stream HW Prefetcher	Enable/Disable L2 Stream HW Prefetcher. Options available: Disable, Enable, Auto. Default setting is Auto .
L2 Up/Down Prefetcher	Use memory access history to determine whether to fetch the next or previous line for all memory accesses. Enable/Disable L2 Up/Down Prefetcher. Options available: Disable, Enable, Auto. Default setting is Auto .
L1 Burst Prefetch Mode	Enable/Disable L1 Burst Prefetch Mode. Options available: Disable, Enable, Auto. Default setting is Auto .

5-3-1-3 Core Watchdog

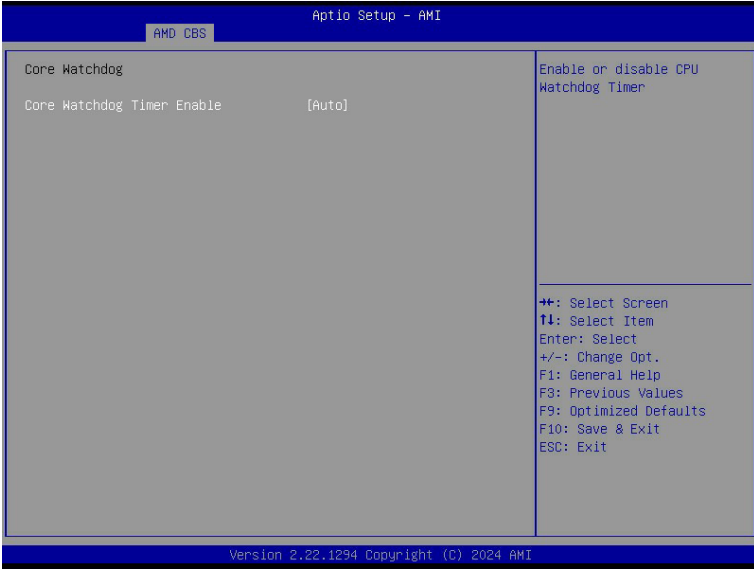

Parameter	Description
Core Watchdog	
Core Watchdog Timer Enable ^(Note)	Enable/Disable CPU Watchdog Timer. Options available: Disabled, Enabled, Auto. Default setting is Auto .
Core Watchdog Timer Interval	Select the CPU Watchdog Timer interval. Options available: 2.681s, 1.340s, 669.41ms, 334.05ms, 166.37ms, 82.53ms, 40.61ms, 20.970ms, 10.484ms, 5.241ms, 2.620ms, 1.309ms, 654.08us, 326.4us, 162.56us, 80.64us, 39.68us, Auto. Default setting is Auto .
Core Watchdog Timer Severity	Options available: No Error, Transparent, Corrected, Deferred, Uncorrected, Fatal, Auto. Default setting is Auto .

(Note) Advanced items prompt when this item is defined.

5-3-2 DF Common Options

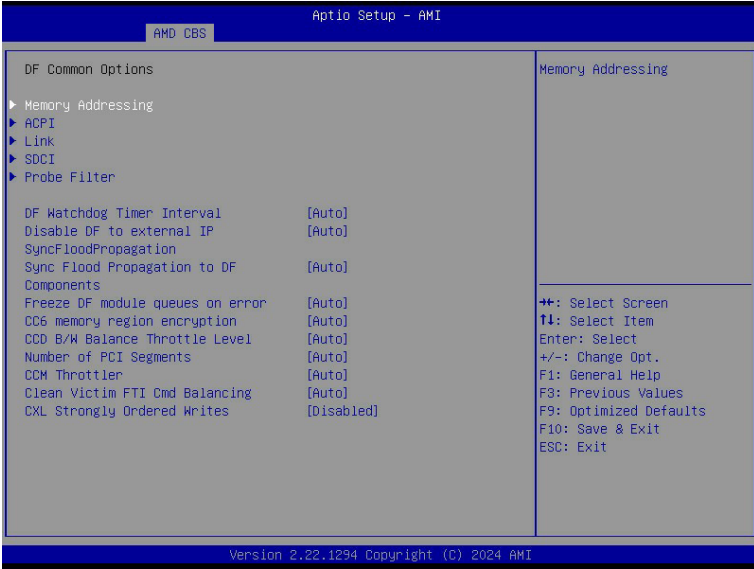

Parameter	Description
DF Common Options	
Memory Addressing	Press [Enter] for configuration of advanced items.
ACPI	Press [Enter] for configuration of advanced items.
Link	Press [Enter] for configuration of advanced items.
SDCI	Press [Enter] for configuration of advanced items.
Probe Filter	Press [Enter] for configuration of advanced items.
DF Watchdog Timer Interval	Configures the Data Fabric watchdog timer interval. Options available: Auto, 41ms, 166ms, 334ms, 669ms, 1.34 seconds, 2.68 seconds, 5.36 seconds. Default setting is Auto .
Disable DF to external IP sync flood propagation	Enable/Disable SyncFlood to UMC & downstream slaves. Options available: Sync flood disabled, Sync flood enabled, Auto. Default setting is Auto .
Sync flood propagation to DF Components	Enable/Disable DF Sync Flood propagation. Options available: Sync flood disabled, Sync flood enabled, Auto. Default setting is Auto .
Freeze DF module queues on error	Options available: Disabled, Enabled, Auto. Default setting is Auto .
CC6 memory region encryption	Controls whether or not the CC6 save/restor memory is encrypted. Options available: Disabled, Enabled, Auto. Default setting is Auto .
CCD B/W Balance Throttle Level	Options available: Auto, Level 0, Level 1, Level 2, Level 3, Level 4. Default setting is Auto .

Parameter	Description
Number of PCI Segments	Options available: Auto, 1 Segment, 2 Segments, 4 Segment. Default setting is Auto .
CCM Throttler	Options available: Disabled, Enabled, Auto. Default setting is Auto .
Clean Victim FTI Cmd Balancing	Options available: Disabled, Enabled, Auto. Default setting is Auto .
CXL Strongly Ordered writes	Options available: Disabled, Enabled, Auto. Default setting is Disabled .

5-3-2-1 Memory Addressing

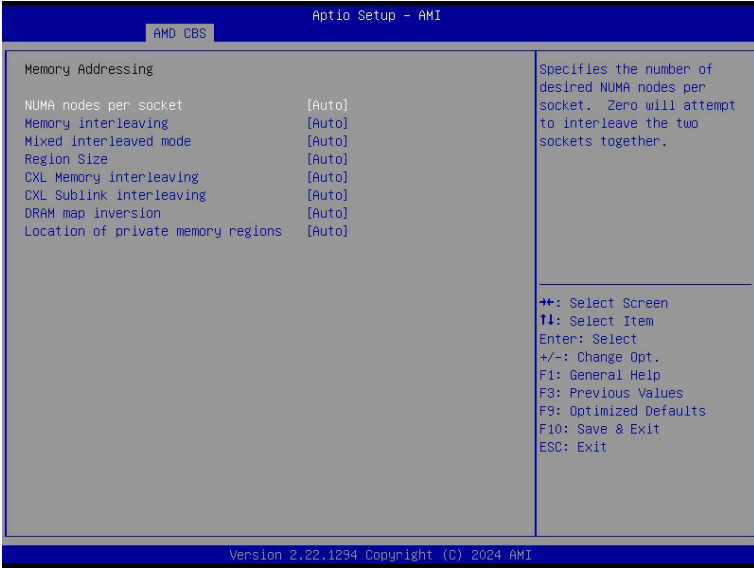

Parameter	Description
Memory Addressing	
NUMA nodes per socket	Specifies the number of desired NUMA nodes per socket. Options available: NPS0, NPS1, NPS2, NPS4, Auto. Default setting is Auto . NOTE! <ul style="list-style-type: none"> • Available options may vary by system configuration. • Only dual processor configuration supports NPS0.
Memory interleaving	Enable/Disable the Memory interleaving feature. Options available: Enabled, Disabled, Auto. Default setting is Auto .
Mixed interleaving mode	Allows for interleaving UMC and CXL together. Options available: Disabled, Auto, Enabled. Default setting is Auto .
Region Size	Options available: 1 K Region Size, 2K Region Size, Auto. Default setting is Auto .
CXL Memory interleaving	Options available: Disabled, Enabled, Auto. Default setting is Auto .
CXL Sublink interleaving	Options available: Enable, Disable, Auto. Default setting is Auto .
DRAM map inversion	Enable/Disable the DRAM map inversion function. Options available: Disabled, Enabled, Auto. Default setting is Auto .
Location of private memory regions	Controls whether or not the private memory regions (PSP, SMU and CC6) are at the top of DRAM or distributed. Options available: Distributed, Consolidated, Auto. Default setting is Auto .

5-3-2-2 ACPI

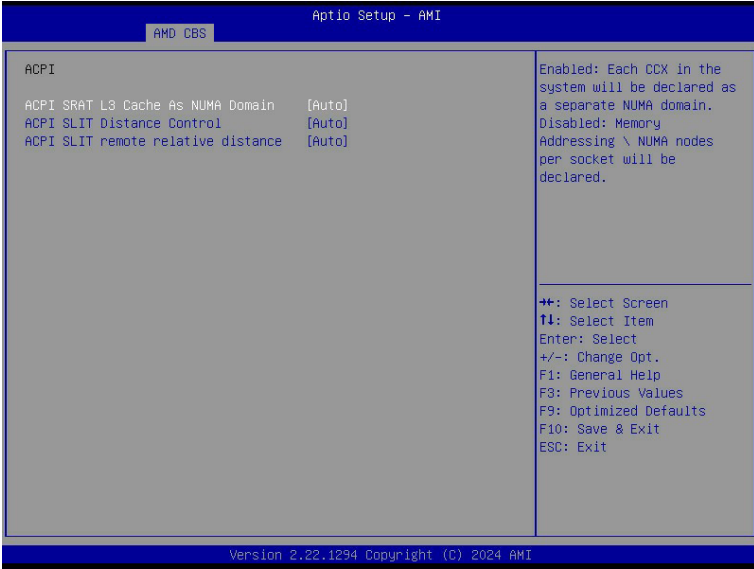

Parameter	Description
ACPI	
ACPI SRAT L3 Cache As NUMA Domain	Enable/Disable report each L3 cache as a NUMA Domain to the OS. Options available: Disabled, Enabled, Auto. Default setting is Auto .
ACPI SLIT Distance Control	Determines how the SLIT distances are declared. Options available: Manual, Auto. Default setting is Auto .
ACPI SLIT remote relative distance	Sets the remote socket distance for 2P systems as near (2.8) or far (3.2). Options available: Near, Far, Auto. Default setting is Auto .

5-3-2-3 Link

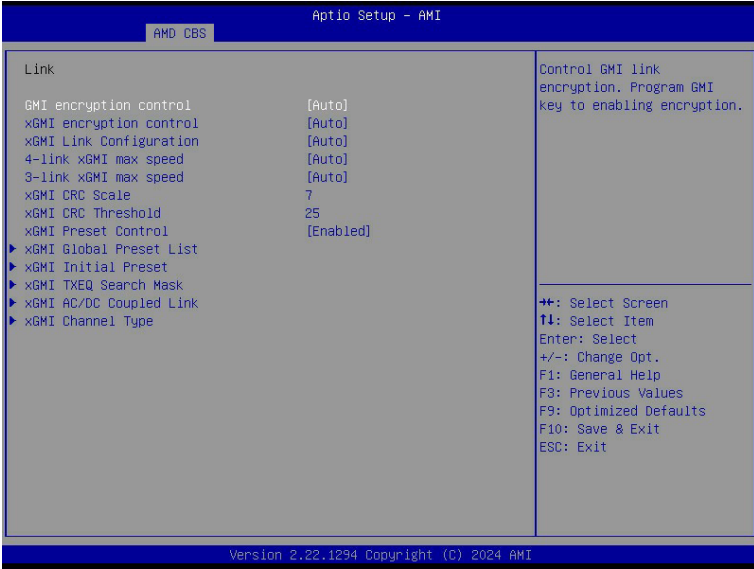

Parameter	Description
GMI encryption control	Enable/Disable GMI link encryption. Options available: Disabled, Enabled, Auto. Default setting is Auto .
xGMI encryption control	Enable/Disable xGMI link encryption. Options available: Disabled, Enabled, Auto. Default setting is Auto .
xGMI Link Configuration	Configures the number of xGMI2 links used on a multi-socket system. Options available: Auto, 3 xGMI Links, 4 xGMI Links, 2 xGMI Links + 2 PCI Links. Default setting is Auto .
4-link xGMI max speed	Specifies the max speed of 4-link xGMI. Options available: 20Gbps, 25Gbps, 32Gbps, Auto. Default setting is Auto .
3-link xGMI max speed	Specifies the max speed of 3-link xGMI. Options available: 20Gbps, 25Gbps, 32Gbps, Auto. Default setting is Auto .
xGMI CRC Scale	Configures leaky bucket scale for xGMI and WAFL CRC errors. Every scale milliseconds an error will leak from the CRC counter. Default setting is 5 .
xGMI CRC Threshold	Configures leaky bucket threshold for xGMI and WAFL CRC errors. If link CRC counter exceeds this threshold, an error will be logged. Default setting is 25 .
xGMI Preset Control	Enable/Disable xGMI Preset control. Options available: Disabled, Enabled, Auto. Default setting is Enabled .

Parameter	Description
xGMI Global Preset List	Press [Enter] to configure the xGMI Preset list.
xGMI Initial Preset	Press [Enter] to configure the xGMI Initial Preset CPU0 link.
xGMI TXEQ Search Mask	Press [Enter] to configure the xGMI TXEQ Search Mask CPU0 link.
xGMI AC/DC Coupled Link	Press [Enter] to configure the xGMI AC/DC Coupled link. ♦ xGMI AC/DC Coupled Link Control ^(Note) – Options available: Manual, Auto. Default setting is Auto .
xGMI Channel Type	Press [Enter] to configure the xGMI Channel Type. ♦ xGMI Channel Type Control ^(Note) – Options available: Manual, Auto. Default setting is Auto .

(Note) Advanced items prompt when this item is defined.

5-3-2-4 SDCI

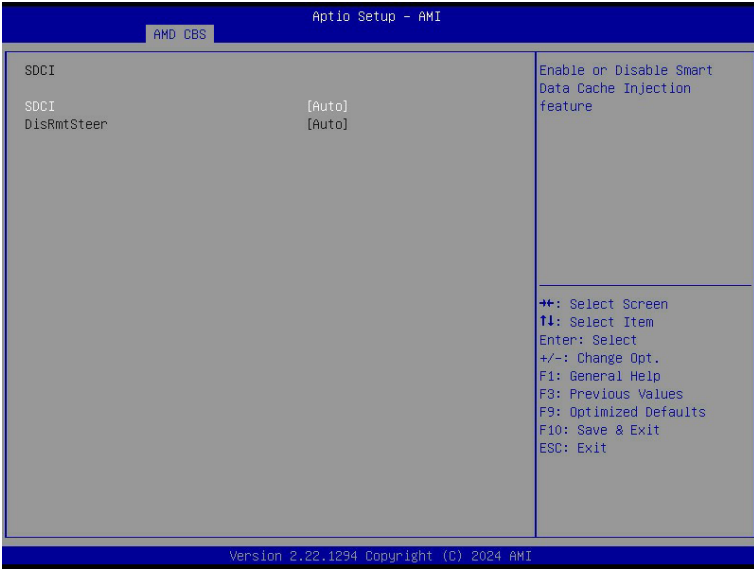

Parameter	Description
SDCI ^(Note)	Options available: Disabled, Enabled, Auto. Default setting is Auto .
DisRmSteer	Options available: Disabled, Enabled, Auto. Default setting is Auto .

(Note) Advanced items prompt when this item is defined.

5-3-2-5 Probe Filter

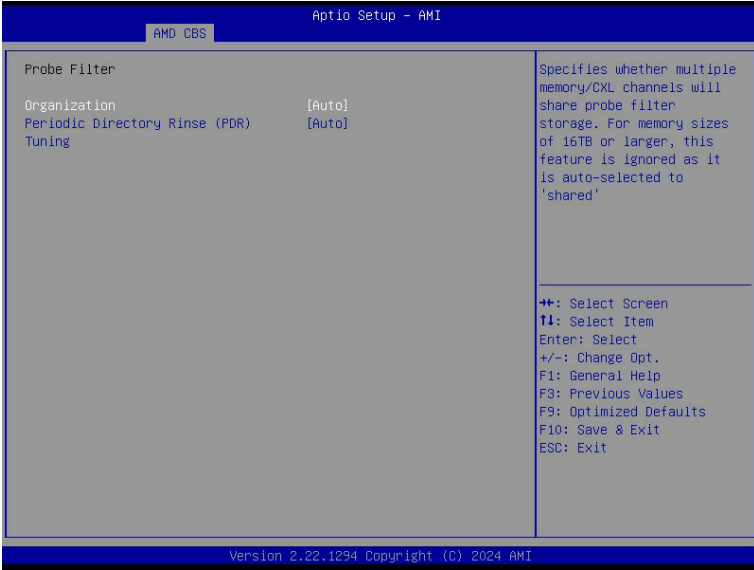

Parameter	Description
Organization	Specifies whether multiple memory/CXL channels will share probe filter storage. Options available: Auto, Dedicated, Shared. Default setting is Dedicated .
Periodic Directory Rinse (PDR) Tuning	Controls PDR settings that may impact performance by workload and/or processor. Options available: Memory-Sensitive, Cache-Bound, Neutral, Adaptive, Auto. Default setting is Auto .

5-3-3 UMC Common Options

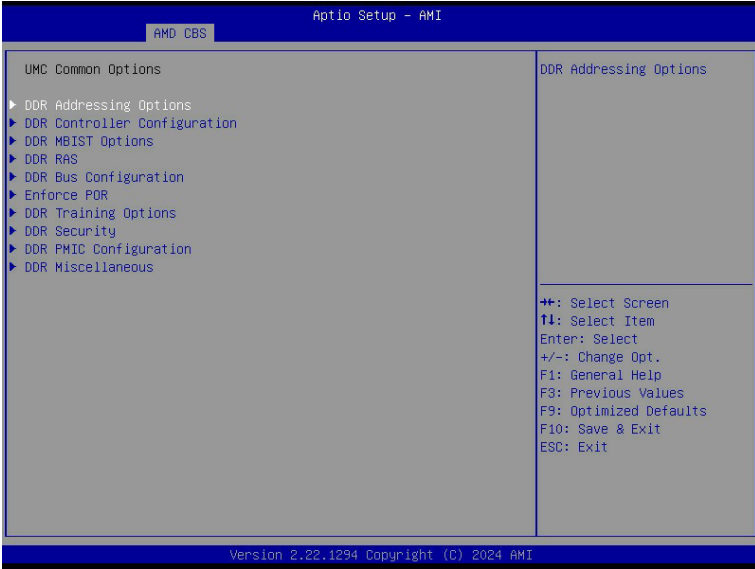

Parameter	Description
UMC Common Options	
DDR Addressing Options	Press [Enter] for configuration of advanced items.
DDR Controller Configuration	Press [Enter] for configuration of advanced items.
DDR MBIST Options	Press [Enter] for configuration of advanced items.
DDR RAS	Press [Enter] for configuration of advanced items.
DDR Bus Configuration	Press [Enter] for configuration of advanced items.
Enforce POR	Press [Enter] for configuration of advanced items.
DDR Training Options	Press [Enter] for configuration of advanced items.
DDR Security	Press [Enter] for configuration of advanced items.
DDR PMIC Configuration	Press [Enter] for configuration of advanced items.
DDR Miscellaneous	Press [Enter] for configuration of advanced items.

5-3-3-1 DDR Addressing Options

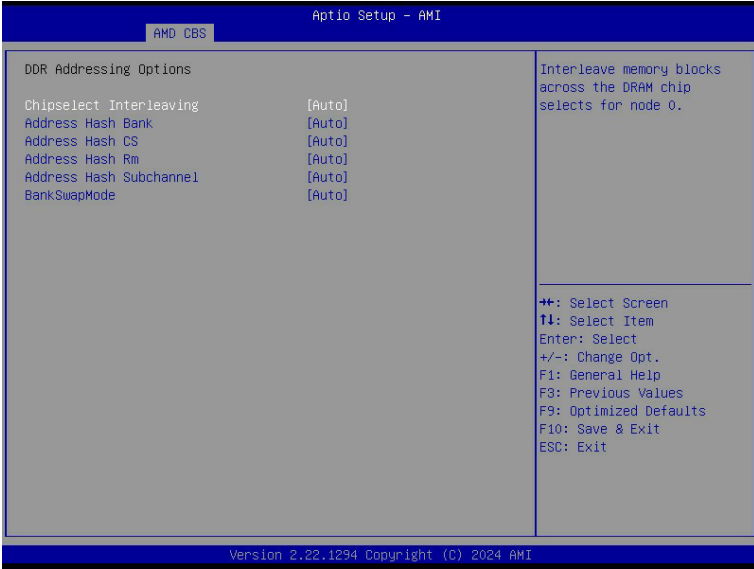

Parameter	Description
DDR Addressing Options	
Chipselect Interleaving	Interleaves memory blocks across the DRAM chip selects for node 0. Options available: Disabled, Auto. Default setting is Auto .
Address Hash Bank	Enable or disable bank addressing hashing. Options available: Disabled, Enabled, Auto. Default setting is Auto .
Address Hash CS	Enable or disable CS addressing hashing. Options available: Auto, Enabled, Disabled. Default setting is Auto .
Address Hash RM	Enable or disable RM addressing hashing for 3DS DIMMs. Options available: Auto, Enabled, Disabled. Default setting is Auto .
Address Hash Subchannel	Enable or disable sub-channel addressing hashing. Options available: Auto, Enabled, Disabled. Default setting is Auto .
BankSwapMode	Options available: Auto, Disabled, Swap CPU. Default setting is Auto .

5-3-3-2 DDR Controller Configuration

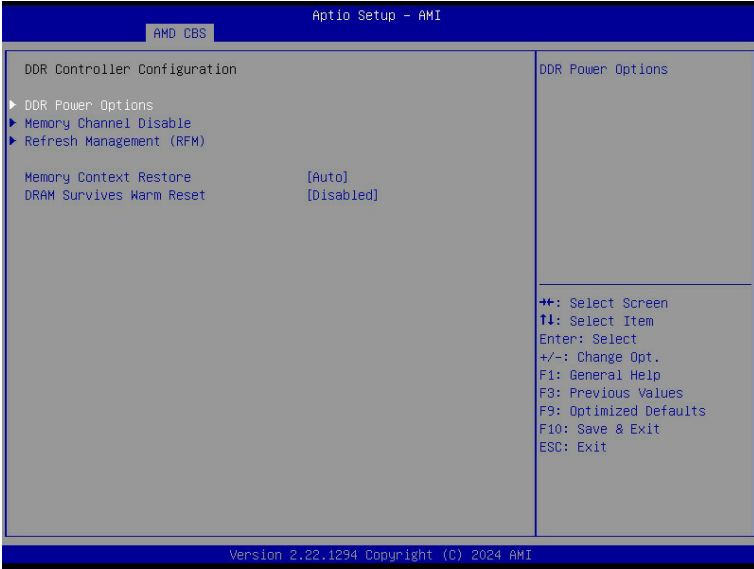

Parameter	Description
DDR Controller Configuration	
DDR Power Options	Press [Enter] for configuration of advanced items.
Memory Channel Disable	Press [Enter] for configuration of advanced items.
Refresh Management (RFM)	Press [Enter] for configuration of advanced items.
Memory Context Restore	Options available: Disabled, Enabled, Auto. Default setting is Auto .
DRAM Survives Warm Reset	Options available: Disabled, Enabled. Default setting is Disabled .

5-3-3-2-1 DDR Power Options

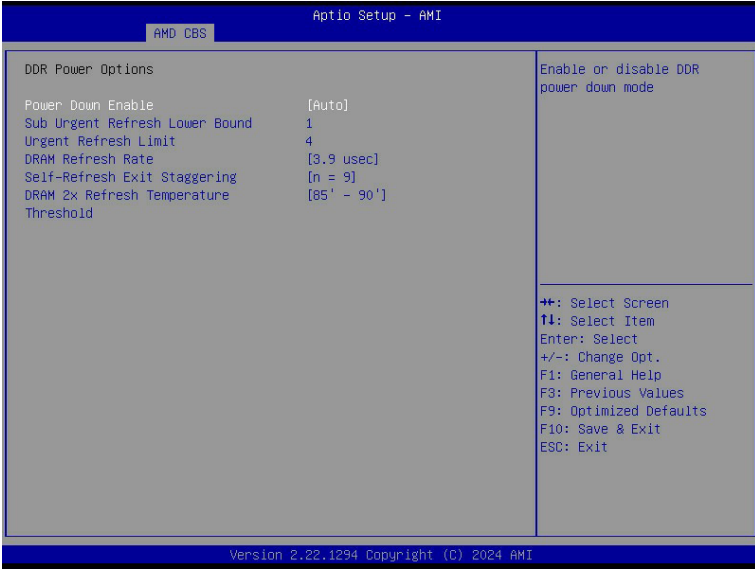

Parameter	Description
DDR Power Options	
Power Down Enable	Enable or disable DDR power down mode. Options available: Disabled, Enabled, Auto. Default setting is Auto .
Sub Urgent Refresh Lower Bound	Specifies the stored refresh limit required to enter sub-urgent refresh mode.
Urgent Refresh Limit	Specifies the stored refresh limit required to enter urgent refresh mode.
DRAM Refresh Rate	DRAM refresh rate: 1.95us or 3.9us. Options available: 3.9 usec, 1.95 usec. Default setting is 3.9 usec .
Self-Refresh Exit Staggering	Options available: Disabled, n=1~9. Default setting is n=9 .
DRAM 2X Refresh Temperature Threshold	Options available: 85-100. Default setting is 85-90 .

5-3-3-2-2 Memory Channel Disable

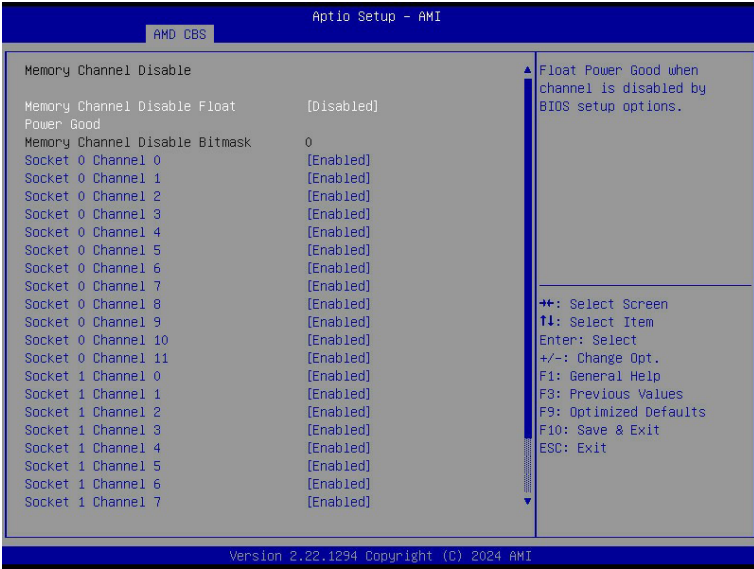

Parameter	Description
Memory Channel Disable	
Memory Channel Disable Bitmask	
CPU0/1 Channel_#	Press [Enter] to enable/disable specific memory channel.

5-3-3-2-3 Refresh Management (RFM)

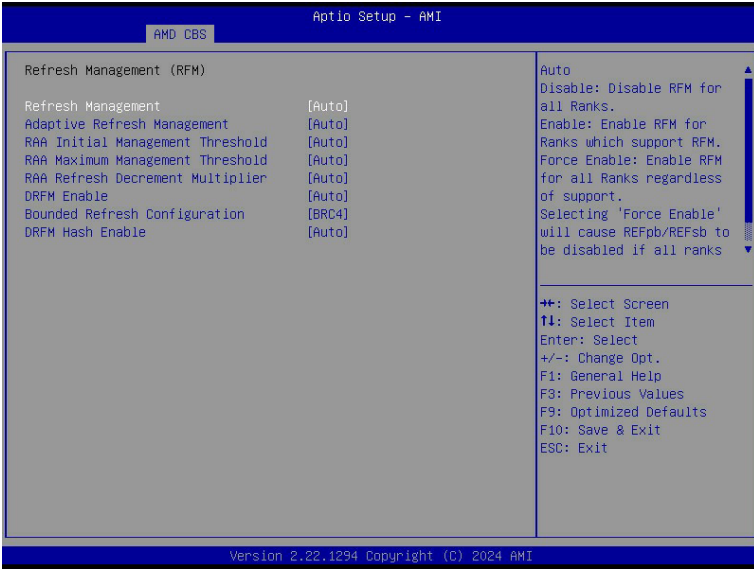

Parameter	Description
Refresh Management (RFM)	
Refresh Management	Configure Refresh Management. Options available: Enable, Disable, Auto, Force Enable. Default setting is Auto .
RAA Initial Management Threshold	Override Rolling Accumulated ACT Initial Management Threshold. Options available: 32, 40, 48, 56, 64, 72, 80, Auto. Default setting is Auto .
RAA Maximum Management Threshold	Override Rolling Accumulated ACT Maximum Management Threshold. Options available: 3X, 4X, 5X, 6X, Auto. Default setting is Auto .
RAA Refresh Decrement Multiplier	Override RAA Refresh Decrement Multiplier. Options available: 0.5, 1, Auto. Default setting is Auto .
DRFM	Options available: Disable, Enable, Auto. Default setting is Auto .
Bounded refresh Configuration	Options available: BRC2, BRC3, BRC4. Default setting is BRC4 .
DRFM Hash Enable	Options available: Disable, Enable, Auto. Default setting is Auto .

5-3-3-3 DDR MBIST Options

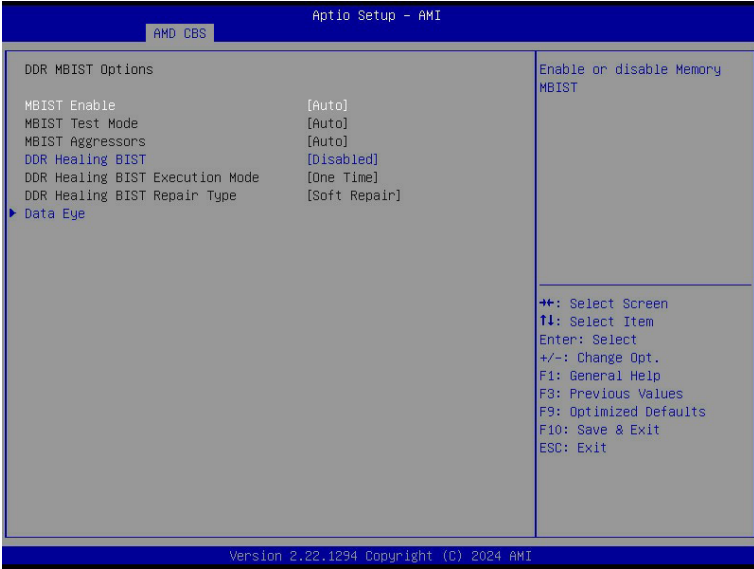

Parameter	Description
DDR MBIST Options	
MBIST Enable	Enable/Disable the Memory MBIST function. Options available: Disabled, Enabled, Auto. Default setting is Auto .
MBIST Test Mode ^(Note1)	Selects MBIST Test Mode. Interface Mode: Tests Single and Multiple CS transactions and Basic Connectivity. Data Eye Mode: Measures Voltage vs. Timing. Options available: Auto, Both, Interface Mode, Data Eye Mode. Default setting is Auto .
MBIST Aggressors ^(Note1)	Enable/Disable MBIST Aggressor test. Options available: Auto, Enabled, Disabled. Default setting is Auto .
DDR Healing BIST ^(Note1)	Options available: Disabled, PMU Mem BIST, Self-Healing Mem BIST, PMU and Self-Healing Mem BIST. Default setting is Disabled .
MBIST Per Bit Slave Die Reporting ^(Note1)	Enable/Disable to report 2D data eye results in ABL log for each DQ, Chipselect, and Channel. Options available: Auto, Enabled, Disabled. Default setting is Auto .

(Note1) This item appears when **MBIST Enable** is set to **Enabled**.

Parameter	Description
Memory Healing BIST	Enable/Disable memory healing BIST. Options available: Disabled, PMU Mem BIST, Self-Healing Mem BIST, PMU and Self-Healing Mem BIST. Default setting is Disabled .
DDR Healing BIST Execution Mode ^(Note2)	Options available: One Time, Every boot. Default setting is One Time .
DDR Healing BIST Repair Type ^(Note2)	For DRAM errors found in the BIOS memory BIST select the repair type. Options available: Soft Repair, Hard Repair, No Repairs - Test only. Default setting is Soft Repair .
Data Eye	Press [Enter] to configure advanced items.

(Note2) This item appears when **DDR Healing BIST** is defined.

5-3-3-3-1 Data Eye

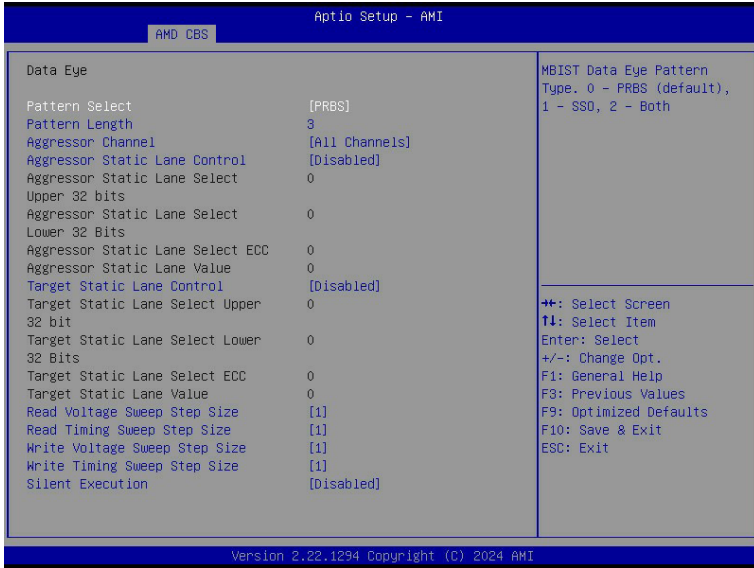

Parameter	Description
Data Eye	
Pattern Select	Options available: PRBS, SSO, Both. Default setting is PRBS .
Pattern Length	Determines the pattern length. The possible options are N=3....12.
Aggressor Channel	This item helps read the aggressors channels. Options available: One Sub-Channel, Half Channels, All Channels. Default setting is All Channels .
Aggressor Static Lane Control	Enable/Disable the Aggressor Static Lane Control function. Options available: Enabled, Disabled. Default setting is Disabled .
Aggressor Static Lane Select Upper 32 bits	This item is configurable when Aggressor Static Lane Control is set to Enabled .
Aggressor Static Lane Select Lower 32 bits	This item is configurable when Aggressor Static Lane Control is set to Enabled .
Aggressor Static Lane Select ECC	This item is configurable when Aggressor Static Lane Control is set to Enabled .
Aggressor Static Lane Value	This item is configurable when Aggressor Static Lane Control is set to Enabled .
Target Static Lane Control	Enable/Disable the Target Static Lane Control function. Options available: Enabled, Disabled. Default setting is Disabled .

Parameter	Description
Target Static Lane Select Upper 32 bits	This item is configurable when Target Static Lane Control is set to Enabled .
Target Static Lane Select Lower 32 bits	This item is configurable when Target Static Lane Control is set to Enabled .
Target Static Lane Select ECC	This item is configurable when Target Static Lane Control is set to Enabled .
Target Static Lane Value	This item is configurable when Target Static Lane Control is set to Enabled .
Worst Case Margin Granularity	Configures Worst Case Margin Granularity. Options available: Per Chip Select, Per Nibble. Default setting is Per Chip Select .
Read Voltage Sweep Step Size	Configures the step size for read Data Eye voltage sweep. Options available: 1, 2, 4. Default setting is 1.
Read Timing Sweep Step Size	Configures the step size for read Data Eye timing sweep. Options available: 1, 2, 4. Default setting is 1.
Write Voltage Sweep Step Size	Configures the step size for write Data Eye voltage sweep. Options available: 1, 2, 4. Default setting is 1.
Write Timing Sweep Step Size	Configures the step size for write Data Eye timing sweep. Options available: 1, 2, 4. Default setting is 1.
Silent Execution	Execute MBIST Data Eye silently without ABL log output. Options available: Enabled, Disabled. Default setting is Disabled .

5-3-3-4 DDR RAS

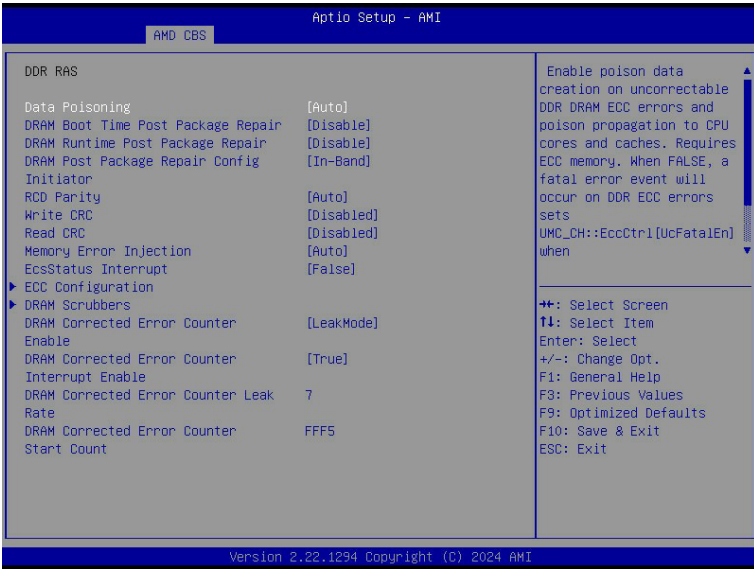

Parameter	Description
DDR RAS	
Data Poisoning	Enable/Disable the Data Poisoning function. Options available: Auto, Enabled, Disabled. Default setting is Auto .
DRAM Boot Time Post Package Repair	Enable/Disable the DRAM Boot Time Post Package Repair function. Options available: Enabled, Disabled. Default setting is Disabled .
DRAM Runtime Post Package Repair	Enable/Disable the DRAM Runtime Post Package Repair function. Options available: Enabled, Disabled. Default setting is Disabled .
DRAM Post Package Repair Config Initiator	Options available: In-Band, Out of Band. Default setting is In-Band .
RCD Parity	Enable/Disable the RCD Parity function. Options available: Auto, Enabled, Disabled. Default setting is Auto .
Write CRC	Options available: Auto, Enabled, Disabled. Default setting is Disabled .
Read CRC	Options available: Auto, Enabled, Disabled. Default setting is Disabled .
EcsStatus Interrupt	Options available: False, True. Default setting is Auto .

Parameter	Description
ECC Configuration	<p data-bbox="399 150 732 174">Press [Enter] to configure advanced items.</p> <ul style="list-style-type: none"> <li data-bbox="399 178 896 260">◆ DRAM ECC Symbol Size <ul style="list-style-type: none"> <li data-bbox="437 208 780 232">– Configures the DRAM ECC Symbol Size. <li data-bbox="437 236 896 260">– Options available: Auto, x4, x16. Default setting is Auto. <li data-bbox="399 268 955 377">◆ DRAM ECC Enable <ul style="list-style-type: none"> <li data-bbox="437 296 940 346">– Enable/Disable DRAM ECC. When set to Auto, it will set ECC to enable. <li data-bbox="437 351 955 401">– Options available: Auto, Enabled, Disabled. Default setting is Auto. <li data-bbox="399 409 955 519">◆ DRAM UECC Retry <ul style="list-style-type: none"> <li data-bbox="437 440 742 464">– Enable/Disable DRAM UECC Retry. <li data-bbox="437 468 955 519">– Options available: Auto, Enabled, Disabled. Default setting is Disabled. <li data-bbox="399 526 713 581">◆ Max DRAM UECC Error Replay^(Note) <ul style="list-style-type: none"> <li data-bbox="437 555 610 578">– Default setting is 8. <li data-bbox="399 589 955 671">◆ Memory Clear <ul style="list-style-type: none"> <li data-bbox="437 617 955 667">– Options available: Auto, Enabled, Disabled. Default setting is Auto. <li data-bbox="399 678 955 749">◆ Address X0R after ECC <ul style="list-style-type: none"> <li data-bbox="437 707 955 749">– Options available: Auto, Enabled, Disabled. Default setting is Auto.

(Note) This item available when **DRAM UECC Retry** is set to **Enabled**.

DRAM Scrubbers	<p>Press [Enter] to configure advanced items.</p> <ul style="list-style-type: none"> ◆ DRAM ECS Mode <ul style="list-style-type: none"> – Options available: Auto, AutoECS, ManualECS, DisableECS. Default setting is Auto. ◆ DRAM Redirect Scrubber Enable <ul style="list-style-type: none"> – Options available: Auto, Enabled, Disabled. Default setting is Auto. ◆ DRAM Scrub Redirection Limit <ul style="list-style-type: none"> – Options available: Auto, 8 Scrubs, 4 Scrubs, 2 Scrubs, 1 Scrub. Default setting is Auto. ◆ DRAM Scrub Time <ul style="list-style-type: none"> – Options available: Disabled, 1 hour, 4 hours, 6 hours, 8 hours, 12 hours, 16 hours, 24 hours, 48 hours. Default setting is 24 Hours. ◆ DRAM Error Threshold Count <ul style="list-style-type: none"> – Options available: Auto, ETC_4, ETC_16, ETC_64, ETC_256, ETC_1024, ETC_4096. Default setting is Auto. ◆ DRAM ECS Count Mode <ul style="list-style-type: none"> – Options available: Auto, Row Count Mode, Code Word Count Mode. Default setting is Auto. ◆ DRAM AutoEcs during Self Refresh <ul style="list-style-type: none"> – Options available: Auto, AutoEcs Disabled, AutoEcs Enabled. Default setting is Auto. ◆ DRAM ECS WriteBack Suppression <ul style="list-style-type: none"> – Options available: Auto, Enable, Disable. Default setting is Auto. ◆ DRAM X4 WriteBack Suppression <ul style="list-style-type: none"> – Options available: Auto, Enable, Disable. Default setting is Auto.
DRAM Corrected Error Counter Enable	<p>Configure DRAM Corrected Error Counter function. Options available: Disable, NoLeakMode, LeakMode. Default setting is LeakMode.</p>
DRAM Corrected Error Counter Interrupt Enable	<p>Enable SMI when DRAM corrected Error Counter count exceeds the threshold value. Options available: False, True. Default setting is True.</p>
DRAM Corrected Counter Leak Rate	<p>Program Rate value for DRAM Corrected Error Counter function. Default setting is 7.</p>
DRAM Corrected Error Counter Start Count	<p>Program starting value for DRAM Corrected Error Counter function. Default setting is FFF5.</p>

Press [Enter] to configure advanced items.

- ◆ DRAM ECS Mode
 - Options available: Auto, AutoECS, ManualECS, DisableECS. Default setting is **Auto**.
- ◆ DRAM Redirect Scrubber Enable
 - Options available: Auto, Enabled, Disabled. Default setting is **Auto**.
- ◆ DRAM Scrub Redirection Limit
 - Options available: Auto, 8 Scrubs, 4 Scrubs, 2 Scrubs, 1 Scrub. Default setting is **Auto**.
- ◆ DRAM Scrub Time
 - Options available: Disabled, 1 hour, 4 hours, 6 hours, 8 hours, 12 hours, 16 hours, 24 hours, 48 hours. Default setting is **24 Hours**.
- ◆ DRAM Error Threshold Count
 - Options available: Auto, ETC_4, ETC_16, ETC_64, ETC_256, ETC_1024, ETC_4096. Default setting is **Auto**.
- ◆ DRAM ECS Count Mode
 - Options available: Auto, Row Count Mode, Code Word Count Mode. Default setting is **Auto**.
- ◆ DRAM AutoEcs during Self Refresh
 - Options available: Auto, AutoEcs Disabled, AutoEcs Enabled. Default setting is **Auto**.
- ◆ DRAM ECS WriteBack Suppression
 - Options available: Auto, Enable, Disable. Default setting is **Auto**.
- ◆ DRAM X4 WriteBack Suppression
 - Options available: Auto, Enable, Disable. Default setting is **Auto**.

DRAM Scrubbers

Parameter	Description
DRAM Corrected Error Counter Enable	Configure DRAM Corrected Error Counter function. Options available: Disable, NoLeakMode, LeakMode. Default setting is LeakMode .
DRAM Corrected Error Counter Interrupt Enable	Enable SMI when DRAM corrected Error Counter count exceeds the threshold value. Options available: False, True. Default setting is True .
DRAM Corrected Counter Leak Rate	Program Rate value for DRAM Corrected Error Counter function. Default setting is 7 .
DRAM Corrected Error Counter Start Count	Program starting value for DRAM Corrected Error Counter function. Default setting is FFF5 .

5-3-3-5 DDR Bus Configuration



Parameter	Description
DDR Bus Configuration	
P-State 0 Dram ODT Impedance	<p>Press [Enter] to configure advanced items.</p> <ul style="list-style-type: none"> ◆ RTT_NOM_WR P-State 0 <ul style="list-style-type: none"> – Default setting is Auto. ◆ RTT_NOM_RD P-State 0 <ul style="list-style-type: none"> – Default setting is Auto. ◆ RTT_WR P-State 0 <ul style="list-style-type: none"> – Default setting is Auto. ◆ RTT_PARK P-State 0 <ul style="list-style-type: none"> – Default setting is Auto. ◆ DQS_RTT PARK P-State 0 <ul style="list-style-type: none"> – Default setting is Auto.
P-State 1 Dram ODT Impedance	<p>Press [Enter] to configure advanced items.</p> <ul style="list-style-type: none"> ◆ RTT_NOM_WR P-State 1 <ul style="list-style-type: none"> – Default setting is Auto. ◆ RTT_NOM_RD P-State 1 <ul style="list-style-type: none"> – Default setting is Auto. ◆ RTT_WR P-State 1 <ul style="list-style-type: none"> – Default setting is Auto. ◆ RTT_PARK P-State 1 <ul style="list-style-type: none"> – Default setting is Auto. ◆ DQS_RTT PARK P-State 1 <ul style="list-style-type: none"> – Default setting is Auto.

<p>Processor ODT Pull Up impedance</p>	<p>Select the ODT impedance for all DBYTE IOs. Options available: Auto, High Impedance, 480 ohm, 240 ohm, 160 ohm, 120 ohm, 96 ohm, 80 ohm, 68.6 ohm, 60 ohm, 53.3 ohm,48 ohm, 43.6 ohm, 40 ohm, 36.9 ohm, 34.3 ohm, 32 ohm, 30 ohm, 28.2 ohm, 26.7 ohm, 25.3 ohm. Default setting is Auto.</p>
<p>Processor ODT Pull Down impedance</p>	<p>Select the ODT impedance for all DBYTE IOs. Options available: Auto, High Impedance, 480 ohm, 240 ohm, 160 ohm, 120 ohm, 96 ohm, 80 ohm, 68.6 ohm, 60 ohm, 53.3 ohm,48 ohm, 43.6 ohm, 40 ohm, 36.9 ohm, 34.3 ohm, 32 ohm, 30 ohm, 28.2 ohm, 26.7 ohm, 25.3 ohm. Default setting is Auto.</p>
<p>Dram DQ drive strengths</p>	<p>Select the Dram Pull-up and Pull-Down Output Driver Impedance for all DQ and DMI IOs. Options available: Auto, 48 ohm, 40 ohm, 34 ohm, Default setting is Auto.</p>

5-3-3-6 Enforce POR



Parameter	Description
Enforce POR	Decline/Accept to configure the advanced items.
Accept	
Active Memory Timing Settings ^(Note)	Active memory Timing Settings. Options available: Auto, Enabled. Default setting is Auto .
Memory Target Speed	Specifies the memory target speed in MT/s. Options available: Auto, DDR3200, DDR3600, DDR4000, DDR4400, DDR4800, DDR5200, DDR5600. Default setting is Auto .
SPD Timing	Press [Enter] to configure advanced items.
Non-SPD Timing	Press [Enter] to configure advanced items.

(Note) Advanced items prompt when this item is defined.

5-3-3-7 DDR Training Options

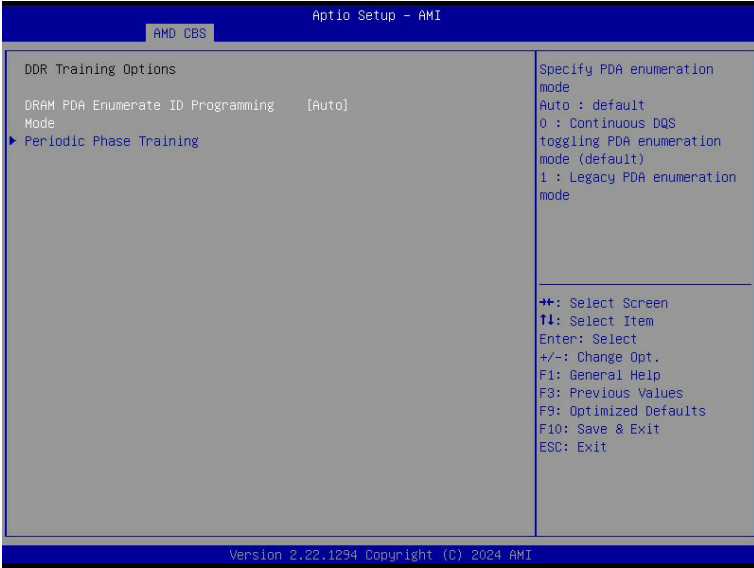

Parameter	Description
DDR Training Options	
DRAM PDA Enumerate ID Programming Mode	Specify PDA enumeration mode. Options available: Auto, Toggling PDA enumeration mode, Legacy PDA enumeration mode. Default setting is Auto .
Periodic Phase Training	Press [Enter] to configure advanced items. <ul style="list-style-type: none"> ◆ Periodic Training Mode <ul style="list-style-type: none"> – Options available: Disabled Legacy. Default setting is Legacy. ◆ Periodic Interval <ul style="list-style-type: none"> – Periodic Interval value in milli-second, in decimal. Range 100-4095 ms.

5-3-3-8 DDR Security

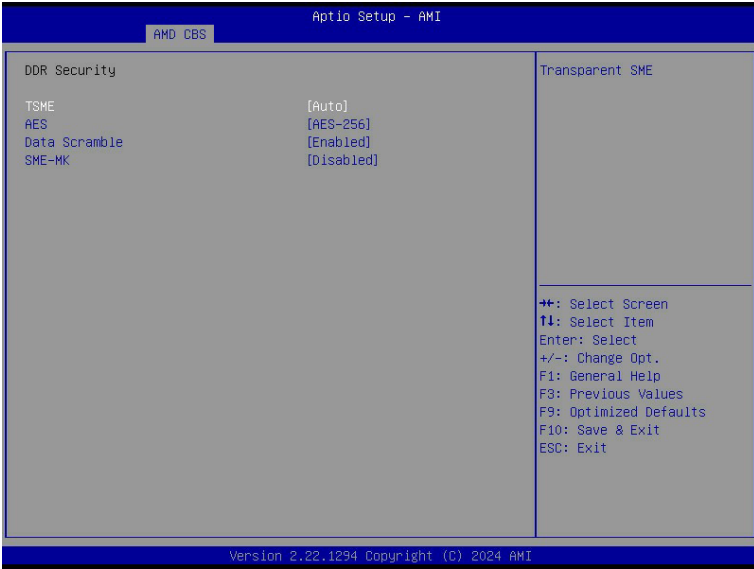

Parameter	Description
Security	
TSME	Enable/Disable Transparent SME. Options available: Auto, Enabled, Disabled. Default setting is Auto .
AES	Options available: AES-128, AES-256. Default setting is AES-256 .
Data Scramble	Enable/Disable Data Scrambling. Options available: Enabled, Disabled. Default setting is Enabled .
SME-MK	Options available: Enabled, Disabled. Default setting is Disabled .

5-3-3-9 DDR PMIC Configuration

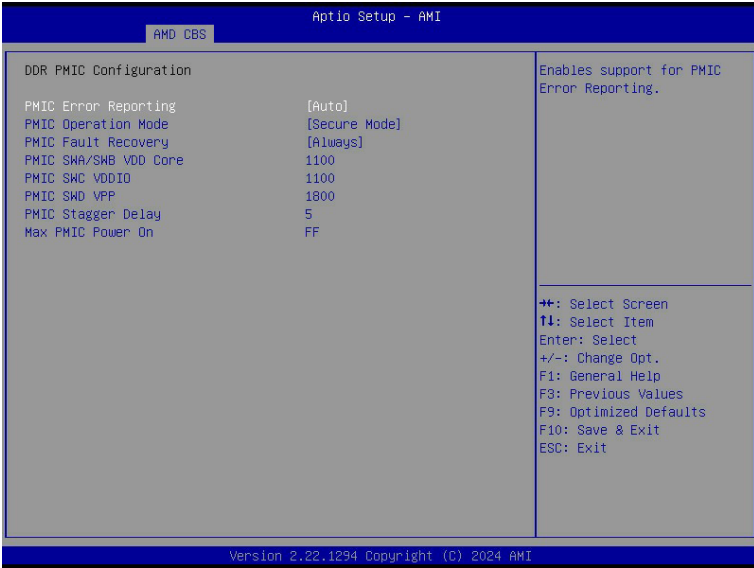

Parameter	Description
DDR PMIC Configuration	
PMIC Error Reporting	Enables support for PMIC Error Reporting. Options available: Auto, False, True. Default setting is Auto .
PMIC Operation Mode	Options available: Secure Mode, Programmable Mode. Default setting is Programmable Mode .
PMIC Fault Recovery	Options available: Always, Never, Once. Default setting is Always .
PMIC SWA/SWB VDD Core	Default setting is 1100 .
PMIC SWC VDDIO	Default setting is 1100 .
PMIC SWD VPP	Default setting is 1800 .
PMIC Stagger Delay	Default setting is 5 .
Max PMIC Power On	Default setting is FF .

5-3-3-10 DDR Miscellaneous

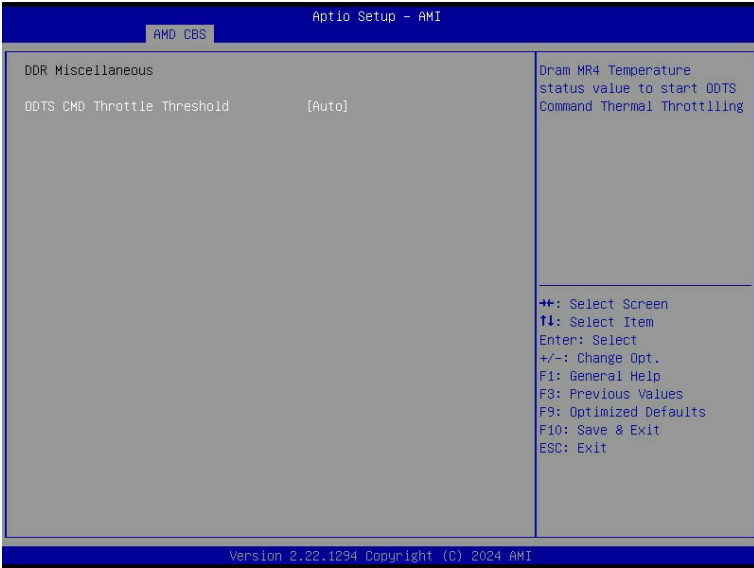

Parameter	Description
DDR Miscellaneous	
ODTS CMD Throttle Threshold	Options available: Auto, > 85°C, > 90°C, > 95°C. Default setting is Auto .

5-3-4 NBIO Common Options

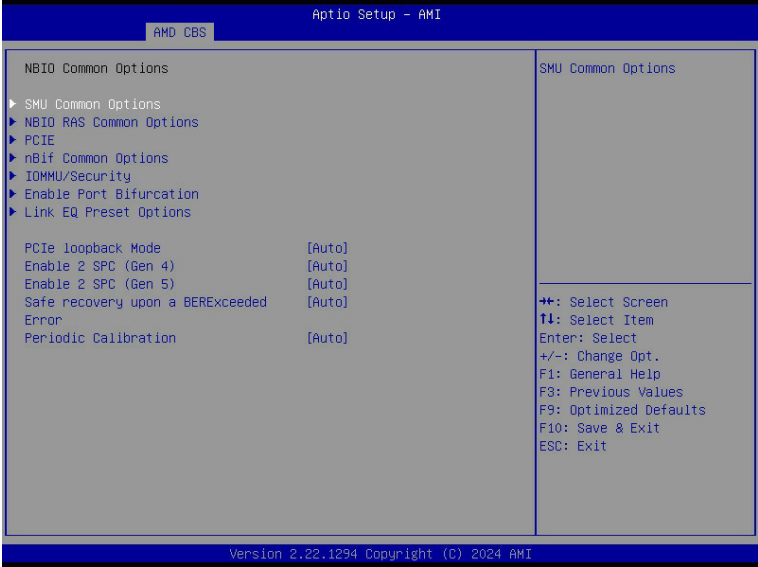

Parameter	Description
NBIO Common Options	
SMU Common Options	Press [Enter] for configuration of advanced items.
NBIO RAS Common Options	Press [Enter] for configuration of advanced items.
PCIe	Press [Enter] for configuration of advanced items.
nBif Common Options	Press [Enter] for configuration of advanced items.
IOMMU/Security	Press [Enter] for configuration of advanced items.
Enable Port Bifurcation	Press [Enter] for configuration of advanced items.
Link EQ Present Options	Press [Enter] for configuration of advanced items.
PCIe loopback Mode	Options available: Disabled, Enabled, Auto. Default setting is Auto .
Enable 2SPC (Gen 4)	Options available: Disabled, Enabled, Auto. Default setting is Auto .
Enable 2SPC (Gen 5)	Options available: Disabled, Enabled, Auto. Default setting is Auto .
Safe recovery upon a BERExceed Error	Options available: Disabled, Enabled, Auto. Default setting is Auto .
Periodic Calibration	Options available: Disabled, Enabled, Auto. Default setting is Auto .

5-3-4-1 SMU Common Options

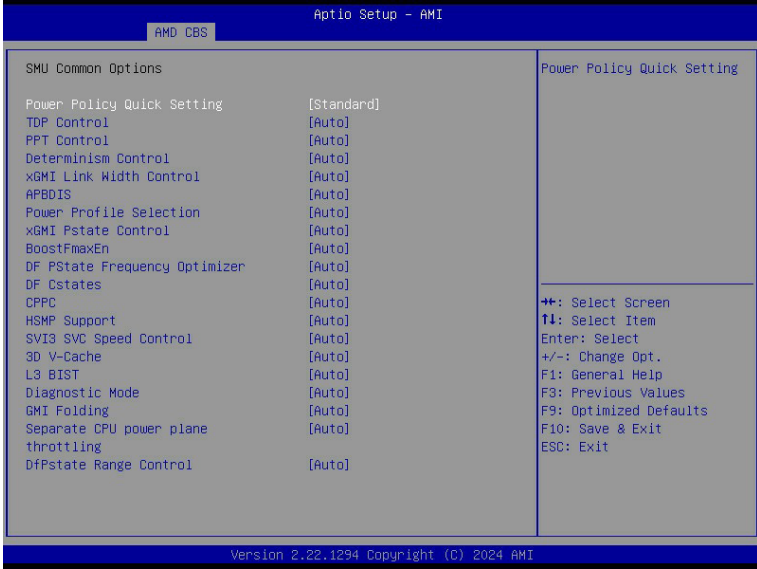

Parameter	Description
SMU Common Options	
Power Policy Quick Setting	Options available: Standard, Best Performance, Energy Efficient. Default setting is Standard .
TDP Control	Options available: Manual, Auto. Default setting is Auto .
PPT Control	Options available: Manual, Auto. Default setting is Auto .
Determinism Control	Selects use the fused Determinism or set customized Determinism. Options available: Manual, Auto. Default setting is Auto .
xGMI Link Width Control	Options available: Manual, Auto. Default setting is Auto .
APBDIS	Options available: 0, 1, Auto. Default setting is Auto .
Power Profile Selection	Options available: High Performance Mode, Efficiency Mode, Maximum IO Performance Mode. Default setting is High Performance Mode .
BoostFmaxEn	Options available: Manual, Auto. Default setting is Auto .
DF PState Frequency Optimizer	Options available: Auto, Enabled, Disabled. Default setting is Auto .
DF Cstates	Options available: Disabled, Enabled, Auto. Default setting is Disabled .

Parameter	Description
CPPC	Enable/Disable the CPPC feature. Options available: Disabled, Enabled, Auto. Default setting is Auto .
HSMP Support	Enable/Disable the HSMP support. Options available: Disabled, Enabled, Auto. Default setting is Auto .
SVI3 SVC Speed Control	Options available: Auto, Manual. Default setting is Auto .
3D V-Cache	Options available: Auto, Disable, 1 stack, 2 stack, 4 stack. Default setting is Auto .
L3 BIST	Options available: Auto, Disable, Enable. Default setting is Auto .
Diagnostic Mode	Options available: Disabled, Enabled, Auto. Default setting is Auto .
GMI Folding	Options available: Disabled, Enabled, Auto. Default setting is Auto .
Separate CPU power plane throttling	Options available: Auto, Disable, Enable. Default setting is Auto .
DfPstate Range Support	Options available: Disable, Enable, Auto. Default setting is Auto .

5-3-4-2 NBIO RAS Common Options

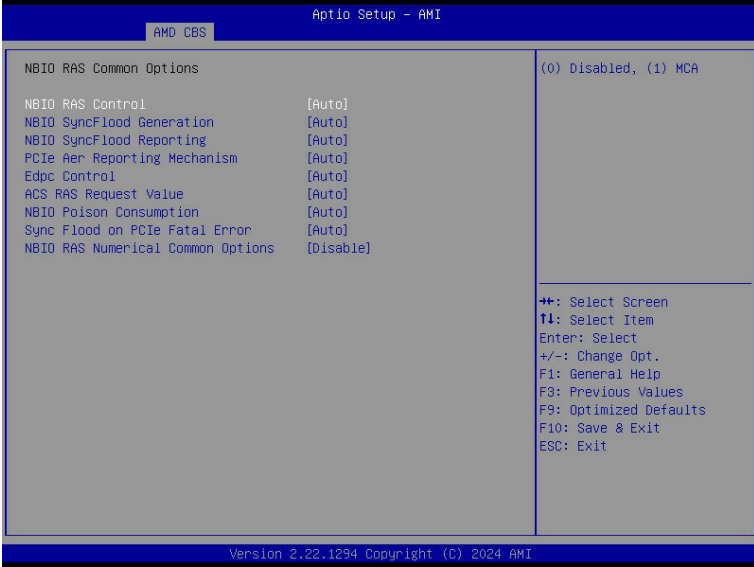

Parameter	Description
NBIO RAS Common Options	
NBIO RAS Control	Options available: Disabled, MCA, Auto. Default setting is Auto .
NBIO SyncFlood Generation	The value may be used to mask SyncFlood caused by NBIO RAS options. Options available: Enabled, Disabled, Auto. Default setting is Auto .
NBIO SyncFlood Reporting	The value may be used to enable SyncFlood reporting to APML. Options available: Enabled, Disabled, Auto. Default setting is Auto .
PCIe Aer Reporting Mechanism	Selects the method of reporting AER errors from PCI Express. Options available: Firmware First, Firmware First but allow OS First, OS First, Auto. Default setting is Auto .
Edpc Control	Options available: Disabled, Enabled, Auto. Default setting is Auto .
ACS RAS Request Value	Options available: Direct Request Access Enabled, Request Blocking Enabled, Request Redirect Enabled, Auto. Default setting is Auto .
NBIO Poison Consumption	Options available: Auto, Enabled, Disabled. Default setting is Auto .
Sync Flood on PCIe Fatal Error	Options available: Auto, True, False. Default setting is Auto .
NBIO RAS Numerical Common Options	Options available: Disable, Manual. Default setting is Disable .

5-3-4-3 PCIE

Aptio Setup - AMI

AMD CBS

<p>PCIE</p> <p>Data Object Exchange [Auto]</p> <p>RTM Margining Support [Auto]</p> <p>Multi Auto Speed Change On Last Rate [Auto]</p> <p>Multi Upstream Auto Speed Change [Auto]</p> <p>Allow Compliance [Auto]</p> <p>EQ Bypass To Highest Rate [Auto]</p> <p>Data Link Feature Cap [Auto]</p> <p>SRIS [Auto]</p> <p>ACS Enable [Auto]</p> <p>PCIE Ten Bit Tag Support [Auto]</p> <p>PCIE ARI Enumeration [Auto]</p> <p>PCIE ARI Support [Auto]</p> <p>Presence Detect Select mode [Auto]</p> <p>Hot Plug Handling mode [Auto]</p> <p>Presence Detect State Settle Time [Auto]</p> <p>Hot Plug Port Settle Time FF</p> <p>Hotplug Support [Auto]</p> <p>Early Link Speed [Auto]</p> <p>Enable AER Cap [Auto]</p> <p>PCIE Link Speed Capability [Auto]</p> <p>PCIE Target Link Speed [Auto]</p> <p>ASPM Control [Auto]</p>	<p>Data Object Exchange (DOE)</p> <hr/> <p>++: Select Screen ↑↓: Select Item Enter: Select +/-: Change Opt. F1: General Help F8: Previous Values F9: Optimized Defaults F10: Save & Exit ESC: Exit</p>
--	--

Version 2.22.1294 Copyright (C) 2024 AMI

Aptio Setup - AMI

AMD CBS

<p>Multi Auto Speed Change On Last Rate [Auto]</p> <p>Multi Upstream Auto Speed Change [Auto]</p> <p>Allow Compliance [Auto]</p> <p>EQ Bypass To Highest Rate [Auto]</p> <p>Data Link Feature Cap [Auto]</p> <p>SRIS [Auto]</p> <p>ACS Enable [Auto]</p> <p>PCIE Ten Bit Tag Support [Auto]</p> <p>PCIE ARI Enumeration [Auto]</p> <p>PCIE ARI Support [Auto]</p> <p>Presence Detect Select mode [Auto]</p> <p>Hot Plug Handling mode [Auto]</p> <p>Presence Detect State Settle Time [Auto]</p> <p>Hot Plug Port Settle Time FF</p> <p>Hotplug Support [Auto]</p> <p>Early Link Speed [Auto]</p> <p>Enable AER Cap [Auto]</p> <p>PCIE Link Speed Capability [Auto]</p> <p>PCIE Target Link Speed [Auto]</p> <p>ASPM Control [Auto]</p> <p>MCTP Enable [Auto]</p> <p>Non-PCIe Compliant Support [Auto]</p> <p>Limit hotplug devices to PCIe boot speed [Auto]</p>	<p>Enabled: Limit hotplug slots to Gen4 if system booted with only Gen4 devices, which optimizes idle power</p> <p>Disabled: Do not limit hotplug slots to Gen4 if system booted with only Gen4 devices, increases idle power</p> <hr/> <p>++: Select Screen ↑↓: Select Item Enter: Select +/-: Change Opt. F1: General Help F8: Previous Values F9: Optimized Defaults F10: Save & Exit ESC: Exit</p>
---	--

Version 2.22.1294 Copyright (C) 2024 AMI

Parameter	Description
PCIE	
Data Object Exchange	Options available: Auto, Disabled, Enabled. Default setting is Auto .
RTM Margining Support	Options available: Auto, Disable, Enable. Default setting is Auto .
Multi Upstram Auto Speed Change On Last Rate	Options available: Auto, Disable, Enable. Default setting is Auto .
Allow Compliance	When enabled, allows the PCIe RP to enter Polling.Compliance state. Options available: Auto, Disable, Enable. Default setting is Auto .
EQ Bypass To Highest Rate	Options available: Disable, Enable, Auto. Default setting is Auto .
Data Link Feature Cap	Options available: Auto, Disabled, Enabled. Default setting is Auto .
SRIS	Options available: Auto, Disable, Enable. Default setting is Auto .
ACS Enable	Enable/Disable ACS. Options available: Enable, Disabled, Auto. Default setting is Auto .
PCIe Ten Bit Tag Support	Enable/Disable PCIe ten bit tags for supported devices. (Auto=Disabled) Options available: Disable, Enable, Auto. Default setting is Auto .
PCIe ARI Enumeration	ARI Forwarding Enable for each downstream port. Options available: Disable, Enable, Auto. Default setting is Auto .
PCIe ARI Support	Enable/Disable Alternative Routing-ID Interpretation. Options available: Disable, Enable, Auto. Default setting is Auto .
Presence Detect Select mode	Controls the Presence Detect Select mode. Options available: OR, AND, Auto. Default setting is Auto .
Hot Plug Handling mode	Controls the Hot Plug Handling mode. Options available: OS First, Firmware First/EDR if OS supports, Firmware First but allow OS First, System Firmware Intermediary, Auto. Default setting is Auto .
Presence Detect State Settle Time	Options available: True, False, Auto. Default setting is Auto .
Hot Plug Port Settle Time	Configure Hot Plug Port Settle Time.
Hot Plug Support	Options available: Auto, Disabled. Default setting is Auto .
Early Link Speed	Configures Early Link Speed. Options available: Auto, Gen1, Gen2. Default setting is Auto .
Enable AER Cap	Enable/Disable Advanced Error Reporting Capability. Options available: Enable, Disabled, Auto. Default setting is Auto .
PCIE Link Speed Capability	Options available: Maximum speed, Gen1, Gen2, Gen3, Gen4, Gen5, Auto. Default setting is Auto .

Parameter	Description
PCIe Target Link Speed	Options available: Maximum Speed, GEN1, GEN2, GEN3, GEN4, GEN5, Auto. Default setting is Auto .
ASPM Control	Options available: Disable, L0s, L1, Auto. Default setting is Auto .
MCTP Enable	Options available: Enable, Disable, Auto. Default setting is Disable .
Non-PCIe Compliant Support	Options available: Enable, Disable, Auto. Default setting is Auto .
Limit hotplug devices to PCIe boot speed	Options available: Enable, Disable, Auto. Default setting is Auto .

5-3-4-4 nBif Common Options

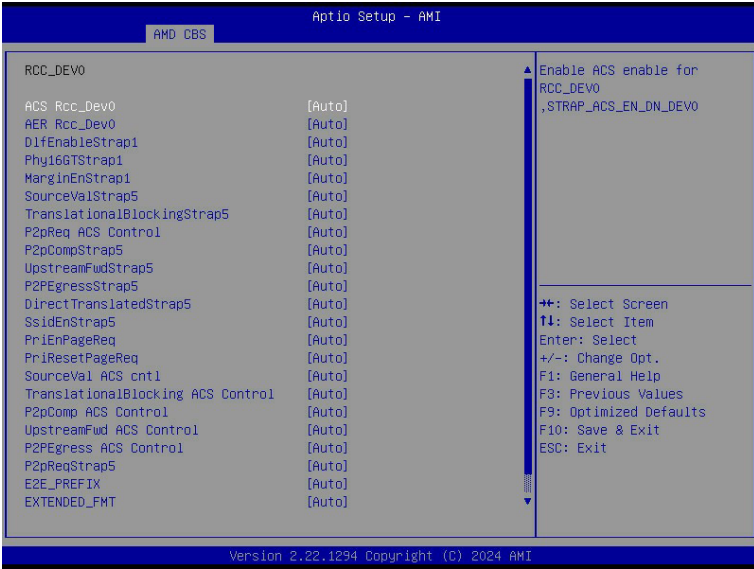

Parameter	Description
RCC_DEV0	<ul style="list-style-type: none"> ◆ ACS Rcc_Dev0 <ul style="list-style-type: none"> – Options available: Auto, Disabled, Enabled. Default setting is Auto. ◆ AER Rcc_Dev0 <ul style="list-style-type: none"> – Options available: Auto, Disabled, Enabled. Default setting is Auto. ◆ DllEnableStrap1 <ul style="list-style-type: none"> – Options available: Auto, Disabled, Enabled. Default setting is Auto. ◆ Phy16GTStrap1 <ul style="list-style-type: none"> – Options available: Auto, Disabled, Enabled. Default setting is Auto. ◆ MarginEnStrap1 <ul style="list-style-type: none"> – Options available: Auto, Disabled, Enabled. Default setting is Auto. ◆ SourceValStrap5 <ul style="list-style-type: none"> – Options available: Auto, Disabled, Enabled. Default setting is Auto. ◆ TranslationalBlockingStrap5 <ul style="list-style-type: none"> – Options available: Auto, Disabled, Enabled. Default setting is Auto. ◆ P2pReq ACS Control <ul style="list-style-type: none"> – Options available: Auto, Disabled, Enabled. Default setting is Auto. ◆ P2pCompStrap5 <ul style="list-style-type: none"> – Options available: Auto, Disabled, Enabled. Default setting is Auto. ◆ UpstreamFwdStrap5 <ul style="list-style-type: none"> – Options available: Auto, Disabled, Enabled. Default setting is Auto.

Parameter	Description
RCC_DEV0 (continued)	<ul style="list-style-type: none"> ◆ P2PEgressStrap5 – Options available: Auto, Disabled, Enabled. Default setting is Auto. ◆ DirectTranslatedStrap5 – Options available: Auto, Disabled, Enabled. Default setting is Auto. ◆ SsidEnStrap5 – Options available: Auto, Disabled, Enabled. Default setting is Auto. ◆ PriEnPageReq – Options available: Auto, Disabled, Enabled. Default setting is Auto. ◆ PriResetPageReq – Options available: Auto, Disabled, Enabled. Default setting is Auto. ◆ SourceVal ACS cntl – Options available: Auto, Disabled, Enabled. Default setting is Auto. ◆ TranslationalBlocking ACS Control – Options available: Auto, Disabled, Enabled. Default setting is Auto. ◆ P2pComp ACS Control – Options available: Auto, Disabled, Enabled. Default setting is Auto. ◆ UpstreamFwd ACS Control – Options available: Auto, Disabled, Enabled. Default setting is Auto. ◆ P2PEgress ACS Control – Options available: Auto, Disabled, Enabled. Default setting is Auto. ◆ P2pReqStrap5 – Options available: Auto, Disabled, Enabled. Default setting is Auto. ◆ E2E_PREFIX – Options available: Auto, Disabled, Enabled. Default setting is Auto. ◆ EXTENDED_FMT – Options available: Auto, Disabled, Enabled. Default setting is Auto. ◆ AtomicRoutingStrap5 – Options available: Auto, Disabled, Enabled. Default setting is Auto.

5-3-4-5 IOMMU/Security

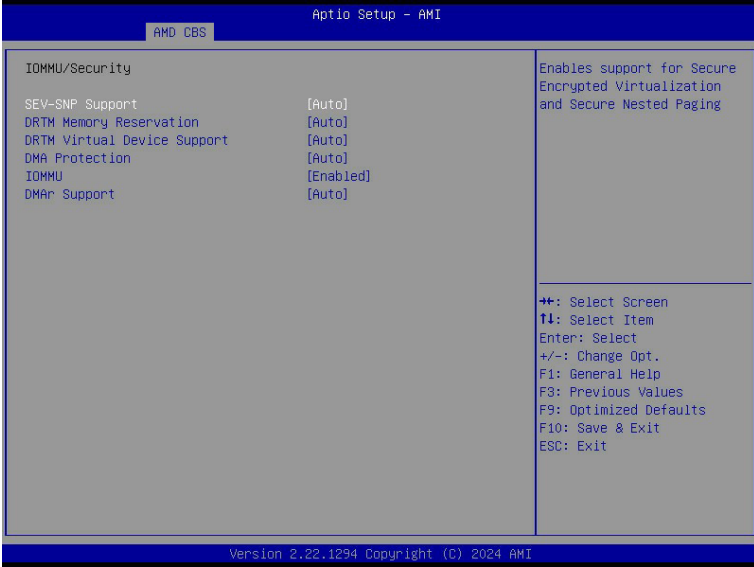

Parameter	Description
SEV-SNP Support	Enable/Disable the SEV-SNP support. Options available: Disable, Enable. Default setting is Disable .
DRTM Memory Reservation	Enable/Disable DRTM Memory reservation. Options available: Disabled, Enabled, Auto. Default setting is Auto .
DRTM Virtual Device Support	Enable/Disable DRTM ACPI virtual device. Options available: Disabled, Enabled, Auto. Default setting is Auto .
DMA Protection	Enable/Disable DMA remap support in IVRS IVinfo Field. Options available: Auto, Enabled, Disabled. Default setting is Auto .
IOMMU	Enable/Disable the IOMMU function. Options available: Disabled, Enabled. Default setting is Enabled .
DMAR Support	Enable/Disable DMAR system protection during POST. Options available: Disabled, Enabled, Auto. Default setting is Auto .

5-3-4-6 Enable Port Bifurcation

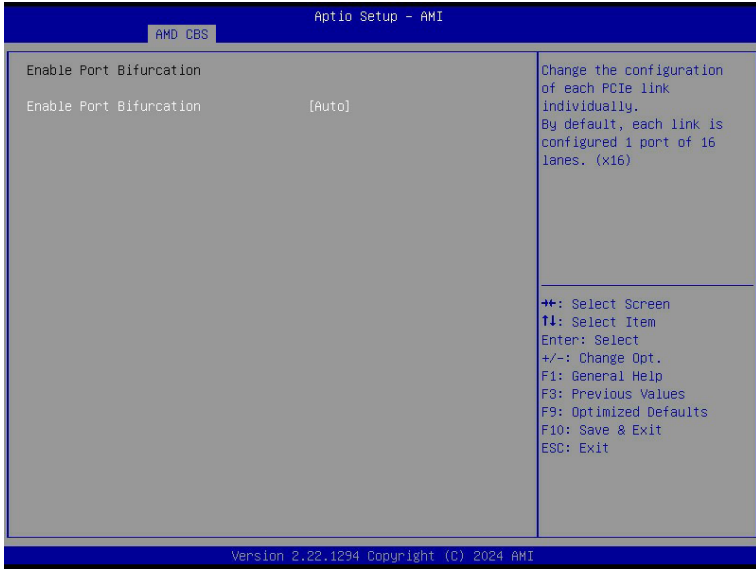

Parameter	Description
Enable Bifurcation ^(Note)	Options available: Disable, Enable, Auto. Default setting is Auto .
Socket0 Slot Info Override	
Socket1 Slot Info Override	

(Note) Advanced items prompt when this item is defined.

5-3-4-7 Link EQ Preset Options

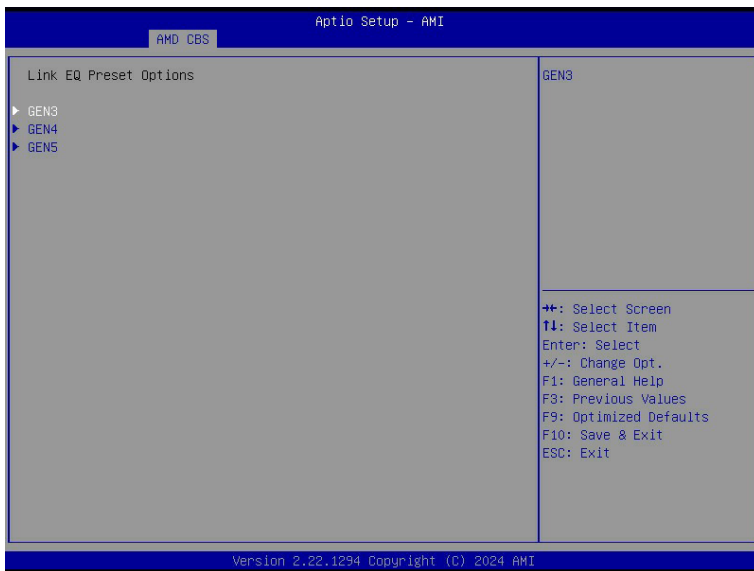

Parameter	Description
GEN3/4/5	<p>Press [Enter] to configure advanced items.</p> <ul style="list-style-type: none"> ◆ Preset Search Mask Configuration <ul style="list-style-type: none"> – Options available: Custom, Auto. Default setting is Auto.

5-3-5 FCH Common Options

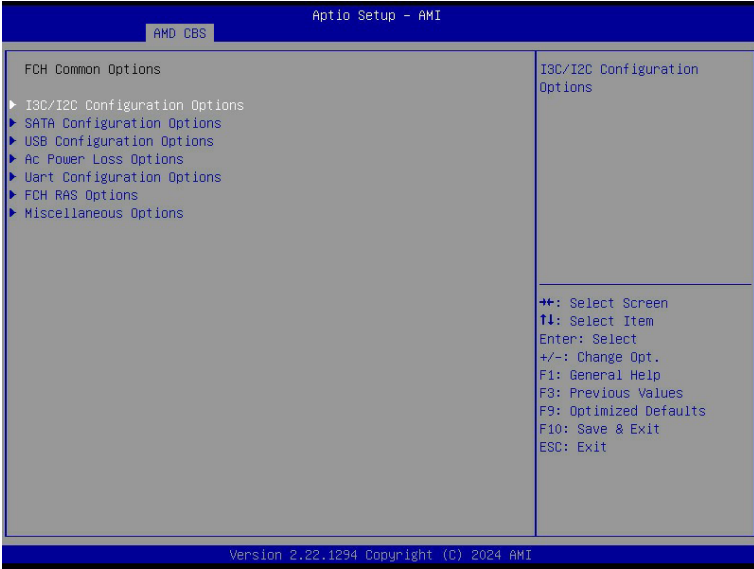

Parameter	Description
FCH Common Options	
I3C/I2C Configuration Options	Press [Enter] for configuration of advanced items.
SATA Configuration Options	Press [Enter] for configuration of advanced items.
USB Configuration Options	Press [Enter] for configuration of advanced items.
AC Power Loss Options	Press [Enter] for configuration of advanced items.
Uart Configuration Options	Press [Enter] for configuration of advanced items.
FCH RAS Options	Press [Enter] for configuration of advanced items.
Miscellaneous Options	Press [Enter] for configuration of advanced items.

5-3-5-1 I3C/I2C Configuration Options

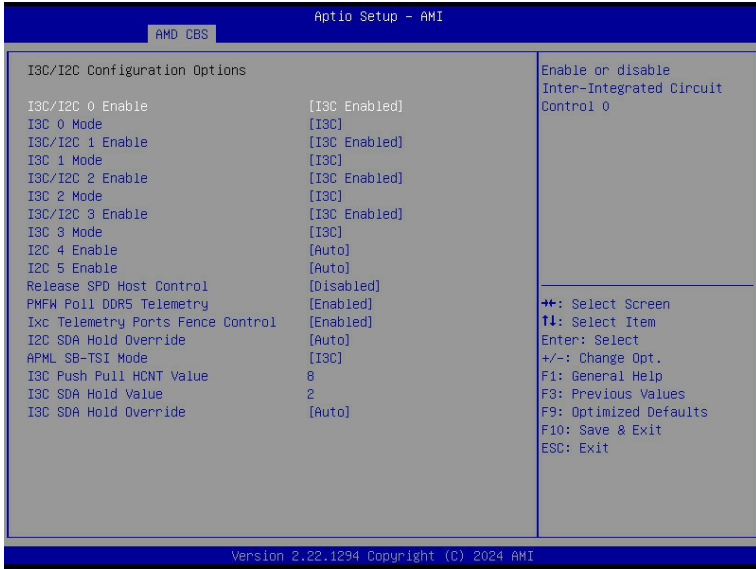

Parameter	Description
I3C/I2C Configuration Options	
I3C/I2C 0/1/2/3 Enable	Options available: Both Disabled, I3C Enabled, I2C Enabled, Auto. Default setting is Auto .
I2C 4/5 Enable	Options available: Disabled, Enabled, Auto. Default setting is Auto .
Release SPD Host Control	Options available: Disabled, Enabled. Default setting is Disabled .
PMFW Poll DDR5 Telemetry	Options available: Disabled, Enabled. Default setting is Enabled .
Ixc Telemetry Ports Fence Control	Options available: Disabled, Enabled. Default setting is Disabled .
I2C SDA Hold Override	Options available: Disabled, Enabled, Auto. Default setting is Auto .
APML SB-TSI \$ RMI Mode	Options available: I3C, I2C. Default setting is I3C .
I3C Mode Speed	Options available: SDR2(6MHz), SDR0(12.5MHz), Auto. Default setting is Auto .
I3C Push Pull HCNT Value	SCL push-pull High count for I3C transfers targeted to I3C devices.
I3C SDA Hold Override	Override I3C SDA Hold value. Options available: Disabled, Enabled, Auto. Default setting is Auto .

5-3-5-2 SATA Configuration Options

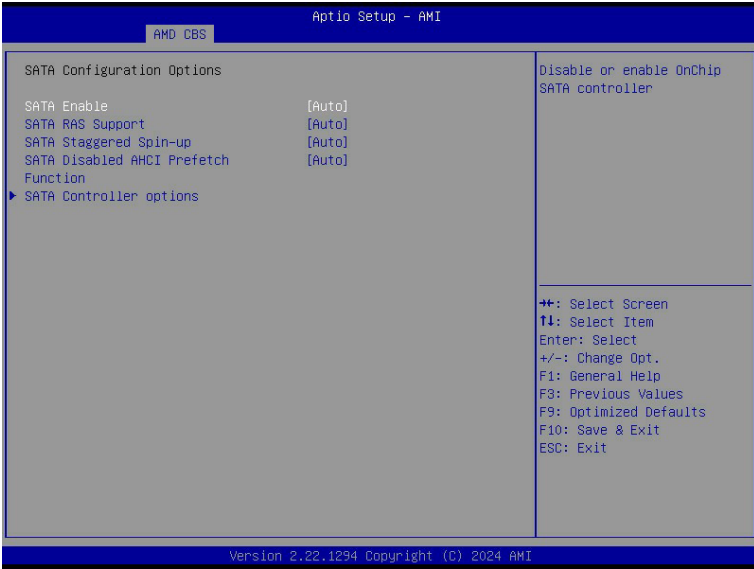

Parameter	Description
SATA Configuration Options	
SATA Enable	Enable/Disable OnChip SATA controller. Options available: Disabled, Enabled, Auto. Default setting is Auto .
SATA RAS Support	Options available: Disabled, Enabled, Auto. Default setting is Auto .
SATA Staggered Spin-up	Options available: Disabled, Enabled, Auto. Default setting is Auto .
SATA Disabled AHCI Prefetch Function	Options available: Disabled, Enabled, Auto. Default setting is Auto .
SATA Controller options	Press [Enter] for configuration of advanced items. <ul style="list-style-type: none"> ◆ SATA Controller Enable ◆ SATA Controller eSATA ◆ SATA Controller DevSlp ◆ SATA Controller SGPIO

5-3-5-3 USB Configuration Options

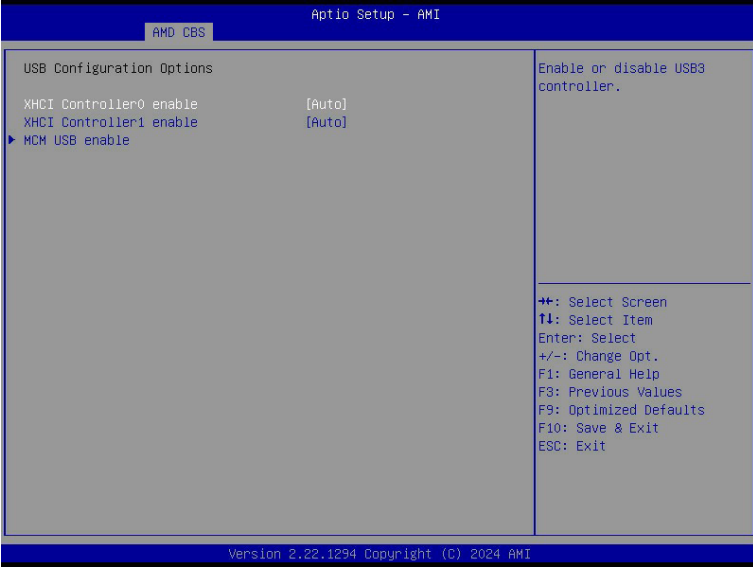

Parameter	Description
USB Configuration Options	
XHCI Controller0/1 enable	Enable/Disable USB controller. Options available: Enabled, Disabled, Auto. Default setting is Auto .
USB ecc SMI Enable	Options available: Enable, Off, Auto. Default setting is Auto .
MCM USB enable	Press [Enter] for configuration of advanced items. <ul style="list-style-type: none"> ◆ XHCI2/ XHCI3 enable (Socket1) <ul style="list-style-type: none"> – Options available: Enabled, Disabled, Auto. Default setting is Auto.

5-3-5-4 AC Power Loss Options

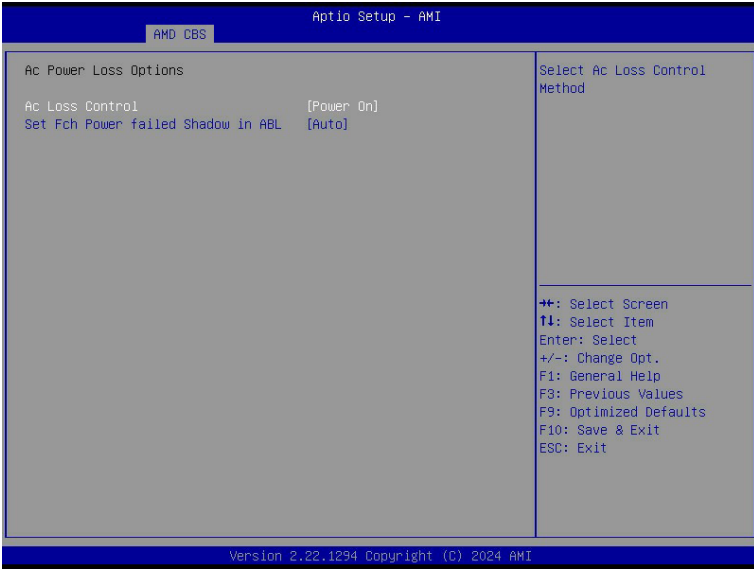

Parameter	Description
AC Power Loss Options	
AC Loss Control	Selects the AC Loss Control Method. Options available: Power Off, Power On, Last State. Default setting is Last State .
Set FCH Power failed shadow in ABL	Enable/Disable set FCH power failed shadow by AC Loss control policy in ABL. Options available: Enabled, Disabled, Auto. Default setting is Auto .

5-3-5-5 Uart Configuration Options

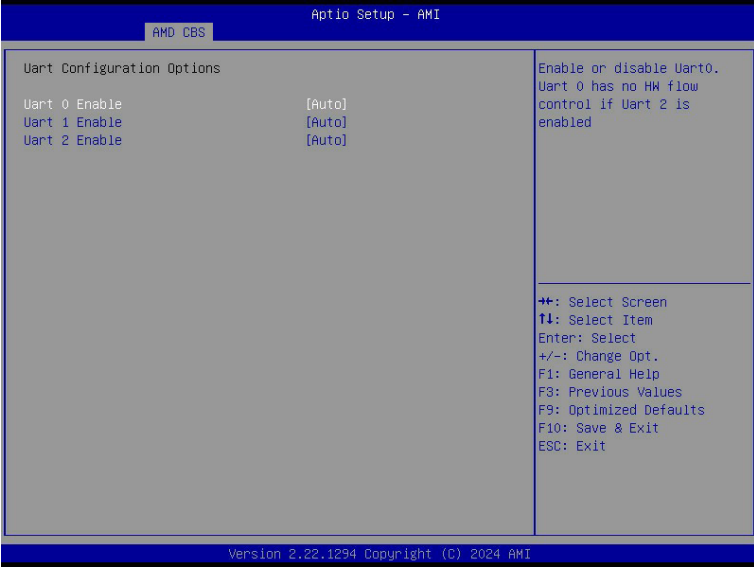

Parameter	Description
Uart Configuration Options	
Uart 0/1/2 Enable	Options available: Disabled, Enabled, Auto. Default setting is Auto .

5-3-5-6 FCH RAS Options



Parameter	Description
FCH RAS Options	
ALink RAS Support	Enable/Disable the ALink RAS Support. Options available: Disabled, Enabled, Auto. Default setting is Auto .
Reset After Sync-Flood	Enables AB to forward downstream sync-flood message to system controller. Options available: Enable, Disable, Auto. Default setting is Auto .

5-3-5-7 Miscellaneous Options

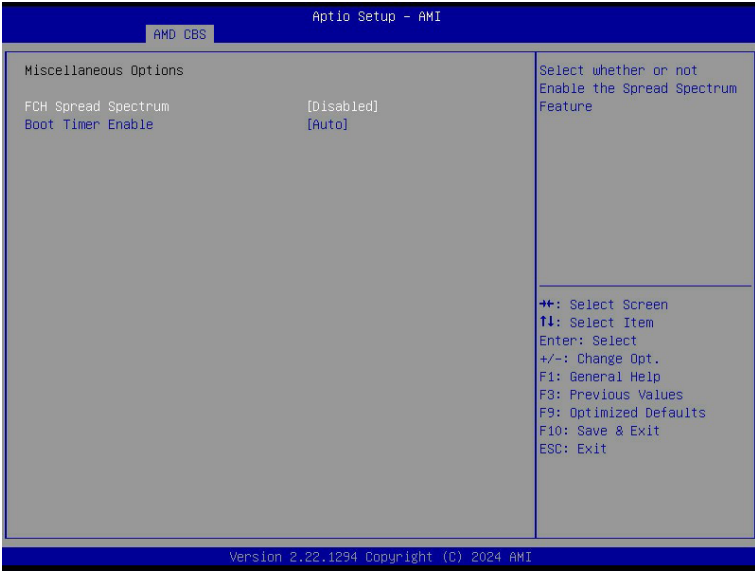

Parameter	Description
Miscellaneous Options	
FCH Spread Spectrum	Select whether or not Enable the Spread Spectrum Feature. Options available: Disabled, Enabled, Auto. Default setting is Auto .
Boot Timer Enable	Enable/Disable Boot Timer. Options available: Disabled, Enabled, Auto. Default setting is Auto .

5-3-6 SOC Miscellaneous Control

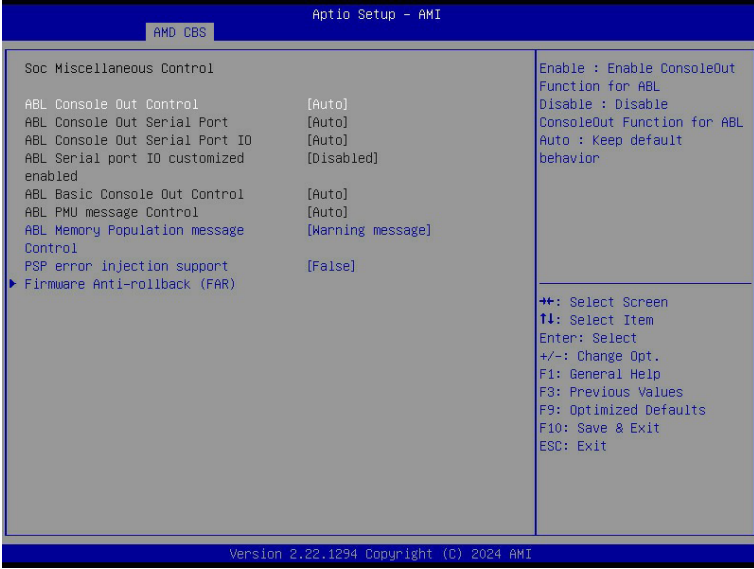

Parameter	Description
SOC Miscellaneous Control	
ABL Console Out Control ^(Note)	Enable/Disable the ConsoleOut function for ABL. Options available: Disable, Enable, Auto. Default setting is Auto .
ABL Console Out Serial Port ^(Note)	Options available: eSPI, SOC UART0, SOC UART1, Auto. Default setting is Auto .
ABL Console Out Serial Port IO	Options available: 0x3F8, 0x2F8, 0x3E8, 0x2E8, Auto. Default setting is Auto .
ABL Basic Console Out Control	Enable/Disable the Basic ConsoleOut function for ABL. Options available: Disable, Enable, Auto. Default setting is Auto .
ABL PMU message Control	To Control the total number of PMU debug messages. Options available: Auto, Detailed debug message, Coarse debug message, Stage completion, Assertion messages, Firmware completion message only. Default setting is Auto .
ABL 2nd CPU PMU MsgBlock Log Control	ABL print 2nd CPU PMU MsgBlock contents after training. Options available: Disabled, Enabled. Default setting is Disabled .
ABL Memory Population message Control	Options available: Warning message, Fatal error. Default setting is Warning message .

(Note) Advanced items are configurable when this item is defined.

Parameter	Description
PSP error injection support	Options available: False, True. Default setting is False .
Firmware Anti-rollback (FAR)	Press [Enter] for configuration of advanced items. <ul style="list-style-type: none"> ◆ FAR enforcement state <ul style="list-style-type: none"> – Default setting is Enabled. ◆ SPL value in the CPU Fuse ◆ SPL value in the SPL table ◆ FAR Switch <ul style="list-style-type: none"> – Options available: Disabled, Enabled, Auto. Default setting is Auto.

5-3-7 CXL Common Options

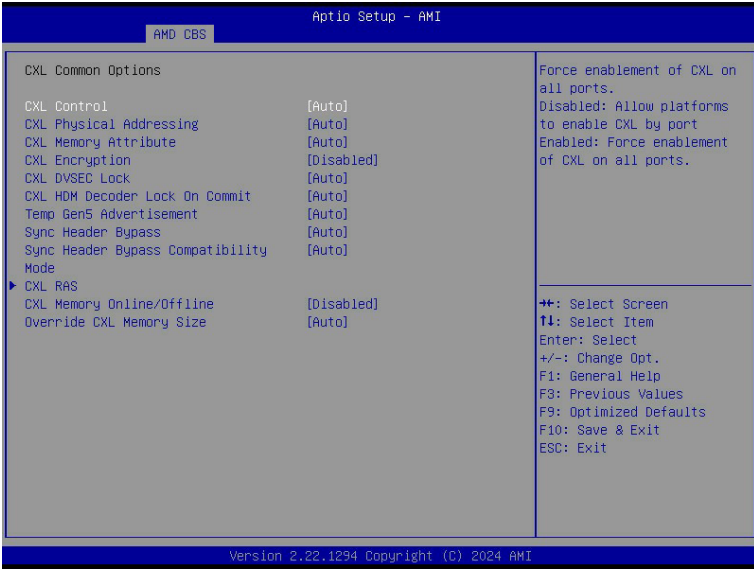

Parameter	Description
CXL Common Options	
CXL Control	Options available: Auto, Enabled, Disabled. Default setting is Auto .
CXL SPM	Options available: Auto, Enabled, Disabled. Default setting is Auto .
CXL Encryption	Options available: Enabled, Disabled. Default setting is Disabled .
CXL DVSEC Lock	Options available: Auto, Enabled, Disabled. Default setting is Auto .
Temp Gen5 Advertisement	Options available: Disabled, Enabled, Auto. Default setting is Auto .
Sync Header Bypass	Options available: Auto, Enabled, Disabled. Default setting is Auto .
Sync Header Bypass Compatibility Node	Options available: Auto, Enabled, Disabled. Default setting is Auto .

Parameter	Description
CXL RAS	<p>Press [Enter] for configuration of advanced items.</p> <ul style="list-style-type: none"> ◆ CXL Protocol Error Reporting <ul style="list-style-type: none"> – Options available: Disabled, SameAsPcieAer, ForceAerFwFirstIfCxlPresent. Default setting is SameAsPcieAer. ◆ CXL Component Error Reporting <ul style="list-style-type: none"> – Options available: OS First, FW-First. Default setting is FW-First. ◆ CXL Root Port Isolation <ul style="list-style-type: none"> – Options available: Auto, Enabled, Disabled. Default setting is Auto. ◆ CXL Component Error Reporting FW Notification. <ul style="list-style-type: none"> – Options available: Auto, Enabled, Disabled. Default setting is Auto.
CXL Memory Online/Offline	<p>All 4 Plink sots support memory online/offline. Only slot4 of Amber supports hot plug CXL memory interleaving automatically disabled globally when this CBS is enabled.</p> <p>Options available: Enabled, Disabled. Default setting is Disabled.</p>
Override CXL Memory Size	<p>Options available: 32GB, 64GB, 28GB, Auto. Default setting is Auto.</p>

5-4 AMD PBS Menu

AMD PBS Option menu displays submenu options for configuring the function of AMD PBS. Select a submenu item, then press [Enter] to access the related submenu screen.

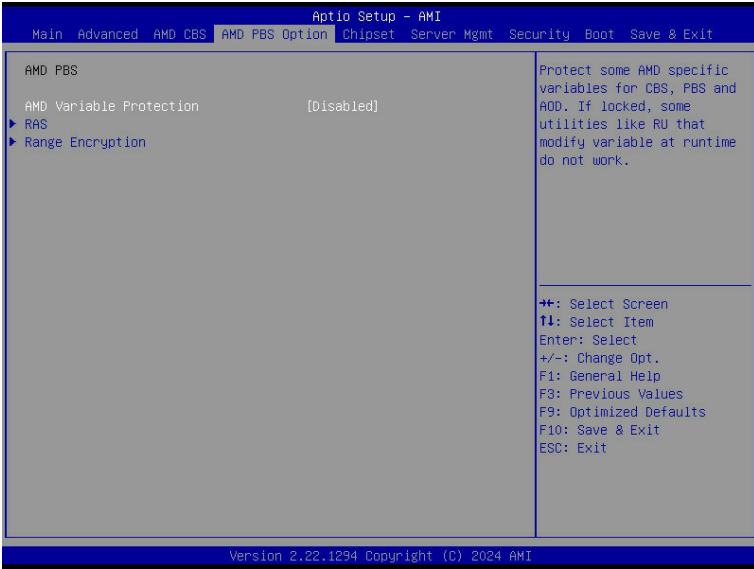

Parameter	Description
AMD Variable Protection	Protect some AMD specific variables for CBS, PBS and AOD. If locked, some utilities like RU that modify variable at runtime do not work. Options available: Disabled, Enabled. Default setting is Disabled .
RAS	Press [Enter] for configuration of advanced items.
CXL Range Encryption	Press [Enter] for configuration of advanced items. <ul style="list-style-type: none"> ◆ Range 1/2/3/4/5/6/7 <ul style="list-style-type: none"> – Configure the Range 1/2/3/4/5/6/7 Memory Base. – Configure the Range 1/2/3/4/5/6/7 Memory Limit/Size. ◆ Start CXL Range Encryption

5-4-1 RAS



Parameter	Description
RAS Periodic SMI Control	Enable/Disable the Periodic SMI for polling [MCA Threshold] error. Options available: Disabled, Enabled. Default setting is Enabled .
SMI Threshold	Configures the SMI Threshold value.
SMI Scale	Configures the SMI Scale value.
SMI Scale Unit	Defines the unit of time scale. Options available: millisecond, second, minute. Default setting is millisecond .
SMI Period	Configures the SMI Period.
GHEs Notify Type	Selects the Notification type for deferred/ corrected errors. Options available: Polled, SCI. Default setting is Polled .
GHEs UnCorr Notify Type	Selects the Notification type for uncorrected errors. Options available: Polled, NMI. Default setting is NMI .
PCIe GHEs Notify Type	Selects the Notification type for PCIe corrected errors. Options available: Polled, SCI. Default setting is Polled .
PCIe UnCorr GHEs Notify Type	Selects the Notification type for PCIe uncorrected errors. Options available: Polled, NMI. Default setting is NMI .
PCIe Root Port Corr Err Mask Reg	Initialize the PCIe AER Corrected Error Mask register of Root Port.

Parameter	Description
PCIe Root Port UnCorr Err Mask Reg	Initialize the PCIe AER Uncorrected Error Mask register of Root Port.
PCIe Root Port UnCorr Err Sev Reg	Initialize the PCIe AER Uncorrected Error Severity register of Root Port.
PCIe Device Corr Err Mask Reg	Initialize the PCIe AER Corrected Error Mask register of PCIe device.
PCIe Device UnCorr Err Mask Reg	Initialize the PCIe AER Uncorrected Error Mask register of PCIe device.
PCIe Device UnCorr Err Sev Reg	Initialize the PCIe AER Uncorrected Error Severity register of PCIe device.
CXL DP CIE Mask Enable	Options available: Disabled, Enabled. Default setting is Enabled .
DRAM Hard Post Package Repair	This feature allows spare DRAM rows to replace malfunctioning rows via an in-field repair mechanism. Options available: Disabled, Enabled. Default setting is Disabled .
HEST DMC Structure Support	HEST DMC (Deferred Machine Check) Structure Support. Options available: Disabled, Enabled. Default setting is Disabled .
CXL Error Report Support	Enable/Disable CXL Error Reporting. Options available: Disabled, Enabled. Default setting is Disabled .

5-4-2 Range Encryption

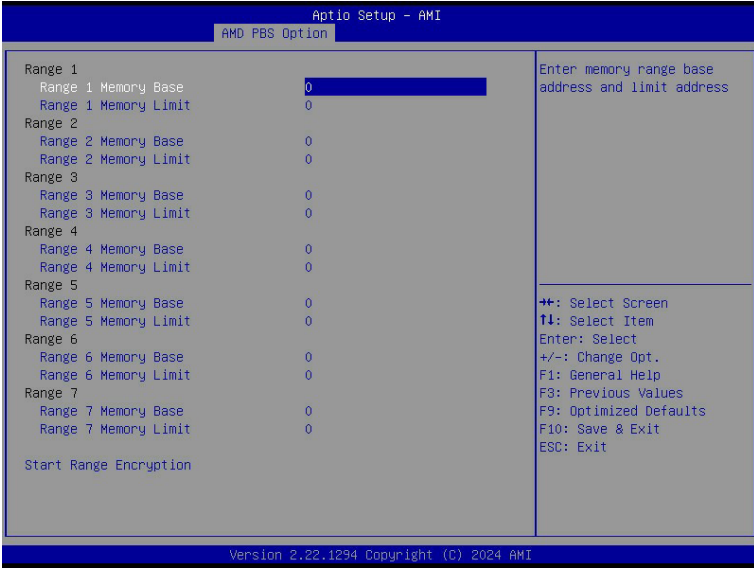

Parameter	Description
Range_#	
Range_# Memory Base	Enter memory base address and limit address.
Start CXL Range Encryption	Start to encrypt all memory ranges.

5-5 Chipset Setup Menu

Chipset Setup menu displays submenu options for configuring the function of the North Bridge. Select a submenu item, then press <Enter> to access the related submenu screen.

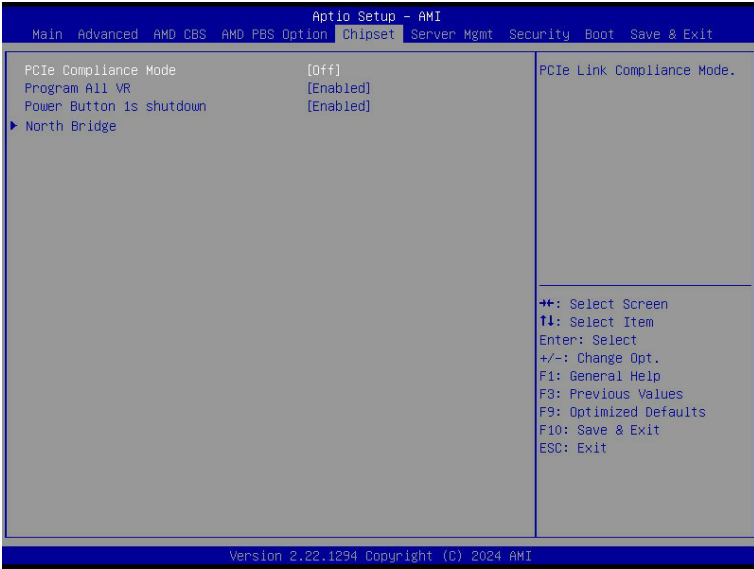

Parameter	Description
PCIe Compliance Mode	Options available: Off, On. Default setting is Off .
Program All VR	Enable/Disable program all VR on MB. Options available: Disabled, Enabled. Default setting is Enabled .
Power Button 1s shutdown	Enable/Disable Press power button 1 sec shutdown. Options available: Disabled, Enabled. Default setting is Enabled .
North Bridge	Press [Enter] for configuration of advanced items.

5-5-1 North Bridge

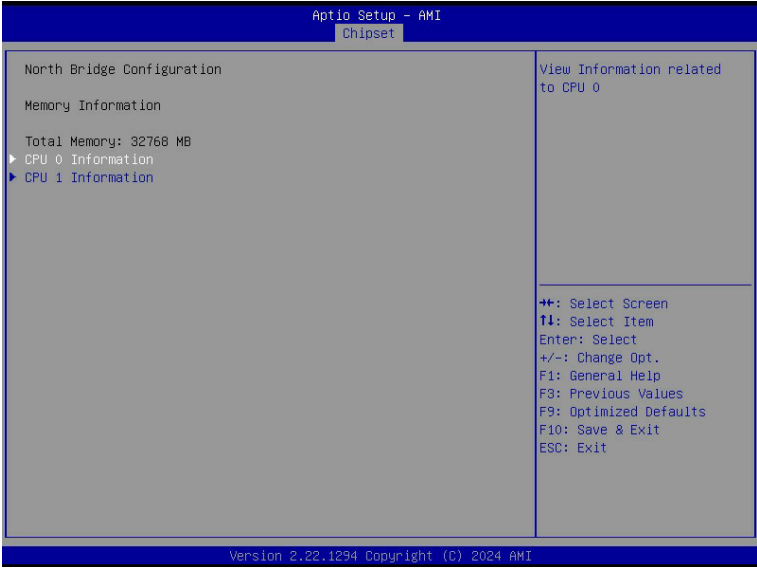

Parameter	Description
North Bridge Configuration	
Memory Information	
Total Memory	Displays the total memory information.
CPU 0 Information	Press [Enter] to view information related to CPU 0

5-6 Server Management Menu

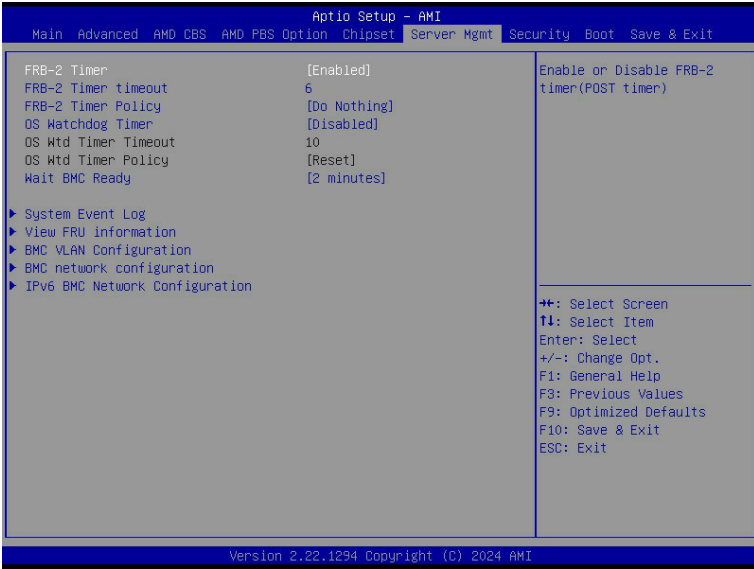

Parameter	Description
FRB-2 Timer	Enable/Disable FRB-2 timer (POST timer). Default setting is Enabled .
FRB-2 Timer timeout	Configures the FRB-2 Timer timeout. Default setting is 20 minutes .
FRB-2 Timer Policy	Configures the FRB-2 Timer policy. Options available: Do Nothing, Reset, Power Down, Power Cycle. Default setting is Do Nothing .
OS Watchdog Timer	Enable/Disable OS Watchdog Timer function. Options available: Enabled, Disabled. Default setting is Disabled .
OS Wtd Timer Timeout ^(Note)	Configures OS Watchdog Timer. Options available: 5 minutes, 10 minutes, 15 minutes, 20 minutes. Default setting is 10 minutes .
OS Wtd Timer Policy ^(Note)	Configure OS Watchdog Timer Policy. Options available: Do Nothing, Reset, Power Down, Power Cycle. Default setting is Reset .
Wait BMC Ready	Post wait BMC ready and reboot system. Options available: Disabled, 2 minutes, 4 minutes, 6 minutes. Default setting is 2 minutes .

(Note) This item is configurable when **OS Watchdog Timer** is set to **Enabled**.

Parameter	Description
System Event Log	Press [Enter] to configure advanced items.
View FRU Information	Press [Enter] to view the FRU information.
BMC VLAN configuration	Press [Enter] to configure advanced items.
BMC network configuration	Press [Enter] to configure advanced items.
IPv6 BMC Network Configuration	Press [Enter] to configure advanced items.

5-6-1 System Event Log

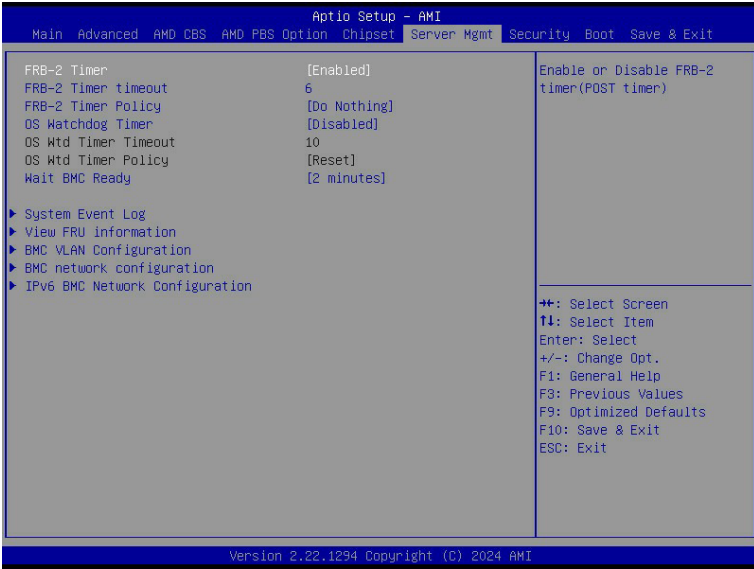

Parameter	Description
Enabling / Disabling Options	
SEL Components	Change this item to enable or disable all features of System Event Logging during boot. Options available: Disabled, Enabled. Default setting is Enabled .
Erasing Settings	
Erase SEL	Choose options for erasing SEL. Options available: No/Yes, On next reset/Yes, On every reset. Default setting is No .
When SEL is Full	Choose options for reactions to a full SEL. Options available: Do Nothing, Erase Immediately. Default setting is Do Nothing .
Custom EFI Logging Options	
Log EFI Status Codes	Enable/Disable the logging of EFI Status Codes (if not already converted to legacy). Options available: Disabled, Both, Error code, Progress code. Default setting is Error code .

5-6-2 View FRU Information

The FRU page is a simple display page for basic system ID information, as well as System product information. Items on this window are non-configurable.

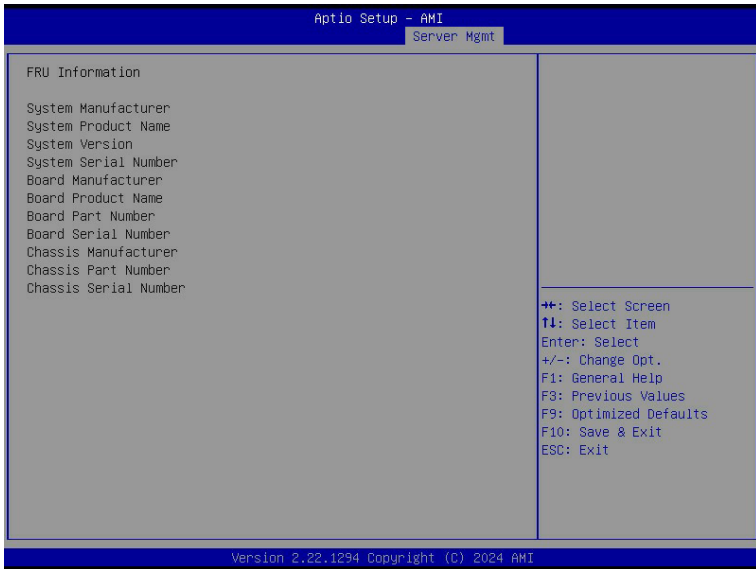

(Note) The model name will vary depends on the product you purchased

5-6-3 BMC VLAN Configuration

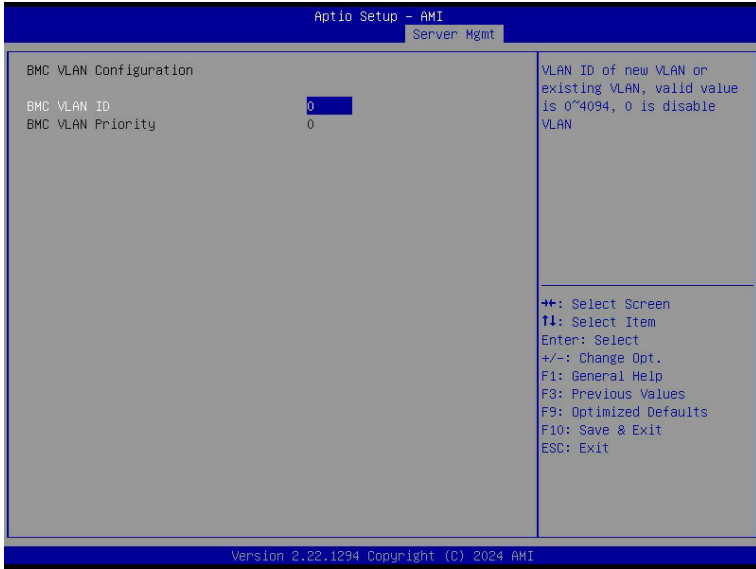

Parameter	Description
BMC VLAN Configuration	
BMC VLAN ID	Select to configure BMC VLAN ID. The valid range is from 0 to 4094. When set to 0, BMC VLAN ID will be disabled.
BMC VLAN Priority	Select to configure BMC VLAN Priority. The valid range is from 0 to 7. When BMC VLAN ID is set to 0, BMC VLAN Priority will not be selected.

5-6-4 BMC Network Configuration

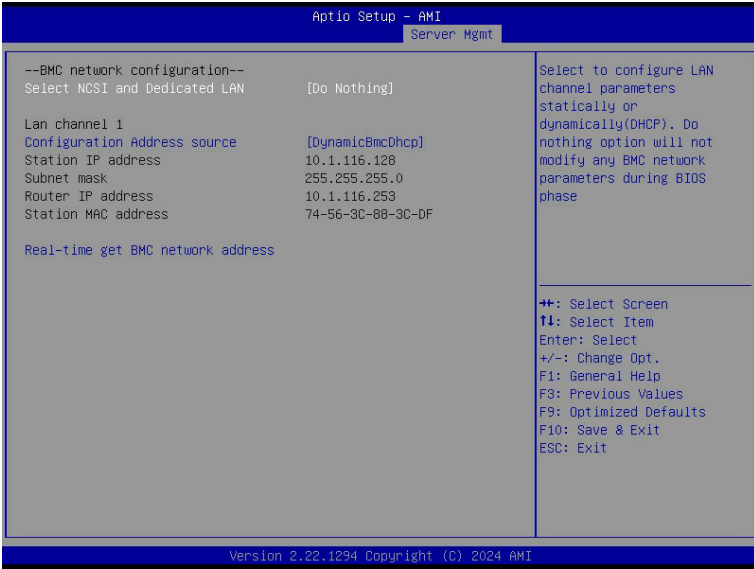

Parameter	Description
BMC network configuration	
Lan Channel 1	
Configuration Address source	Selects to configure LAN channel parameters statically or dynamically (DHCP). Do nothing option will not modify any BMC network parameters during BIOS phase. Options available: Unspecified, Static, DynamicBmcDhcp. Default setting is DynamicBmcDhcp .
Station IP address	Displays IP Address information.
Subnet mask	Displays Subnet Mask information. Please note that the IP address must be in three digitals, for example, 192.168.000.001.
Router IP address	Displays the Router IP Address information.
Station MAC address	Displays the MAC Address information.
VLAN Support	Set BMC to enable/disable VLAN support. Options available: Enabled, Disabled. Default setting is Disabled .
Real-time synchronize BMC network parameter values	Press [Enter] will set Address source(Static/DHCP) to BMC and then get Station IP address, Subnet mask and Router IP address from BMC.

5-6-5 IPv6 BMC Network Configuration



Parameter	Description
IPv6 BMC network configuration	
IPv6 BMC Lan Channel 1	
IPv6 BMC Lan Option	Enable/Disable IPv6 BMC LAN channel function. When this item is disabled, the system will not modify any BMC network during BIOS phase. Options available: Unspecified, Disabled, Enabled. Default setting is Enabled .
IPv6 BMC Lan IP Address Source	Selects to configure LAN channel parameters statically or dynamically (by BIOS or BMC). Options available: Unspecified, Static, Dynamic-Obtained by BMC running DHCP. Default setting is Dynamic-Obtained by BMC running DHCP .
IPv6 BMC Lan IP Address/Prefix Length	Check if the IPv6 BMC LAN IP address matches those displayed on the screen.

5-7 Security Menu

The Security menu allows you to safeguard and protect the system from unauthorized use by setting up access passwords.

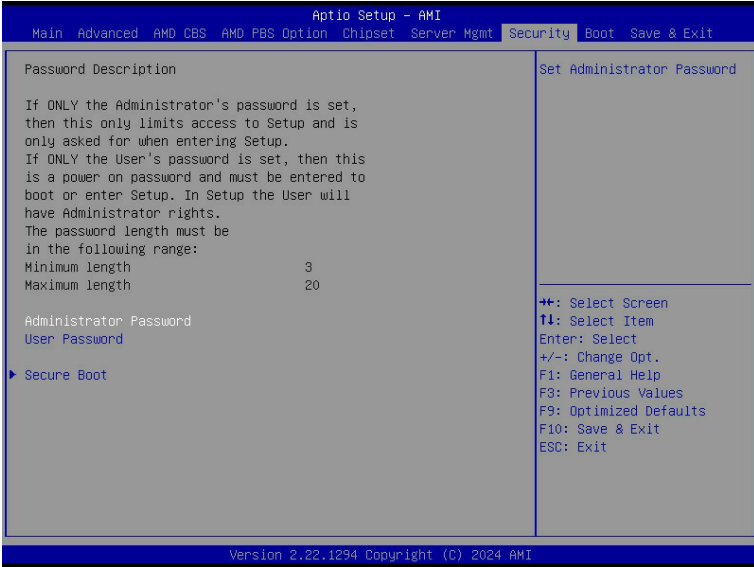

There are two types of passwords that you can set:

- Administrator Password
Entering this password will allow the user to access and change all settings in the Setup Utility.
- User Password
Entering this password will restrict a user's access to the Setup menus. To enable or disable this field, a Administrator Password must first be set. A user can only access and modify the System Time, System Date, and Set User Password fields.

Parameter	Description
Administrator Password	Press [Enter] to configure the administrator password.
User Password	Press [Enter] to configure the user password.
Secure Boot	Press [Enter] to configure advanced items.

5-7-1 Secure Boot

The Secure Boot feature is applicable if supported by your Operating System. If your Operating System is not supporting Secure Boot, the system will hang when starting the Operating System.



Parameter	Description
System Mode	Displays if the system is in User mode or Setup mode.
Secure Boot	Enable/ Disable the Secure Boot function. Options available: Enabled, Disabled. Default setting is Disabled .
Secure Boot Mode ^(Note)	Secure Boot requires all the applications that are running during the booting process to be pre-signed with valid digital certificates. This way, the system knows all files being loaded before the Operating System loads to the login screen have not been tampered with. When set to Standard, it will automatically load the Secure Boot keys from the BIOS databases. When set to Custom, you can customize the Secure Boot settings and manually load its keys from the BIOS database. Options available: Standard, Custom. Default setting is Standard .
Restore Factory Keys	Forces the system to user mode and installs factory default Secure Boot key database.
Reset To Setup Mode	Press [Enter] to reset the system mode to Setup mode.
Enter Audit Mode	Press [Enter] to set the system mode to audit mode.

(Note) Advanced items prompt when this item is set to **Custom**.

Parameter	Description
Expert Key Management	<p data-bbox="335 156 665 180">Press [Enter] to configure advanced items.</p> <p data-bbox="335 185 941 235">Please note that this item is configurable when Secure Boot Mode is set to Custom.</p> <ul style="list-style-type: none"> <li data-bbox="335 243 946 352">◆ Factory Key Provision <ul style="list-style-type: none"> <li data-bbox="367 266 946 321">– Allows to provision factory default Secure Boot keys when system is in Setup Mode. <li data-bbox="367 326 909 352">– Options available: Enabled, Disabled. Default setting is Disabled. <li data-bbox="335 357 931 431">◆ Restore Factory Keys <ul style="list-style-type: none"> <li data-bbox="367 381 931 404">– Installs all factory default keys. It will force the system in User Mode. <li data-bbox="367 409 606 431">– Options available: Yes, No. <li data-bbox="335 435 904 517">◆ Enroll Efi Image <ul style="list-style-type: none"> <li data-bbox="367 459 904 517">– Press [Enter] to enroll SHA256 hash of the binary into Authorized Signature Database (db). <li data-bbox="335 522 899 572">◆ Secure Boot variable <ul style="list-style-type: none"> <li data-bbox="367 545 899 572">– Displays the current status of the variables used for secure boot. <li data-bbox="335 577 803 682">◆ Platform Key (PK) <ul style="list-style-type: none"> <li data-bbox="367 600 803 627">– Displays the current status of the Platform Key (PK). <li data-bbox="367 631 680 655">– Press [Enter] to configure a new PK. <li data-bbox="367 660 601 682">– Options available: Update. <li data-bbox="335 686 946 823">◆ Key Exchange Keys (KEK) <ul style="list-style-type: none"> <li data-bbox="367 710 946 736">– Displays the current status of the Key Exchange Key Database (KEK). <li data-bbox="367 741 909 796">– Press [Enter] to configure a new KEK or load additional KEK from storage devices. <li data-bbox="367 801 675 823">– Options available: Update, Append. <li data-bbox="335 827 952 964">◆ Authorized Signatures (DB) <ul style="list-style-type: none"> <li data-bbox="367 851 909 878">– Displays the current status of the Authorized Signature Database. <li data-bbox="367 882 952 937">– Press [Enter] to configure a new DB or load additional DB from storage devices. <li data-bbox="367 942 675 964">– Options available: Update, Append. <li data-bbox="335 969 904 1105">◆ Forbidden Signatures (DBX) <ul style="list-style-type: none"> <li data-bbox="367 992 904 1019">– Displays the current status of the Forbidden Signature Database. <li data-bbox="367 1023 893 1078">– Press [Enter] to configure a new dbx or load additional dbx from storage devices. <li data-bbox="367 1083 675 1105">– Options available: Update, Append. <li data-bbox="335 1110 931 1246">◆ Authorized TimeStamps (DBT) <ul style="list-style-type: none"> <li data-bbox="367 1133 931 1160">– Displays the current status of the Authorized TimeStamps Database. <li data-bbox="367 1165 909 1219">– Press [Enter] to configure a new DBT or load additional DBT from storage devices. <li data-bbox="367 1224 675 1246">– Options available: Update, Append. <li data-bbox="335 1251 920 1387">◆ OsRecovery Signatures <ul style="list-style-type: none"> <li data-bbox="367 1274 920 1301">– Displays the current status of the OsRecovery Signature Database. <li data-bbox="367 1306 888 1361">– Press [Enter] to configure a new OsRecovery Signature or load additional OsRecovery Signature from storage devices. <li data-bbox="367 1365 675 1387">– Options available: Update, Append.

5-8 Boot Menu

The Boot menu allows you to set the drive priority during system boot-up. BIOS setup will display an error message if the legacy drive(s) specified is not bootable.

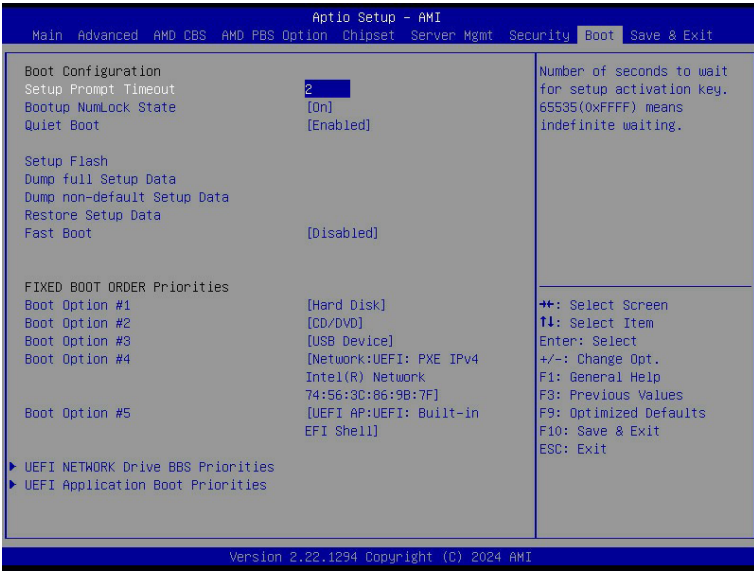

Parameter	Description
Boot Configuration	
Setup Prompt Timeout	Number of seconds to wait for setup activation key. 65535 (0xFFFF) means indefinite waiting. Press the numeric keys to input the desired values.
Bootup NumLock State	Enable/Disable the Bootup NumLock function. Options available: On, Off. Default setting is On .
Quiet Boot	Enable/Disable showing the logo during POST. Options available: Enabled, Disabled. Default setting is Enabled .
Endless Retry Boot	Options available: Enabled, Disabled. Default setting is Disabled .

Parameter	Description
FIXED BOOT ORDER Priorities	
Boot Option #1 / #2 / #3 / #4 / #5	<p>Press [Enter] to configure the boot priority. By default, the server searches for boot devices in the following sequence:</p> <ol style="list-style-type: none"> 1. Hard drive. 2. CD-COM/DVD drive. 3. USB device. 4. Network. 5. UEFI.
UEFI NETWORK Drive BBS Priorities	Press [Enter] to configure the boot priority.
UEFI Application Boot Priorities	Press [Enter] to configure the boot priority.

5-9 Save & Exit Menu

The Save & Exit menu displays the various options to quit from the BIOS setup. Highlight any of the exit options then press <Enter>.

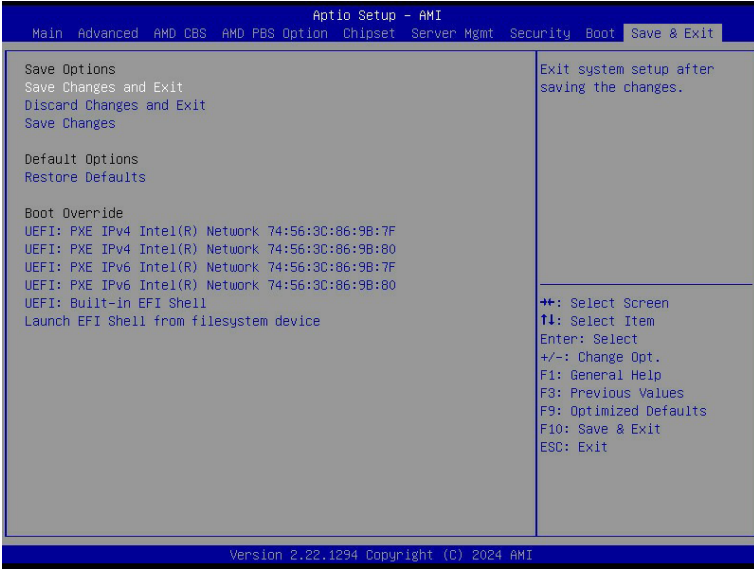

Parameter	Description
Save Options	
Save Changes and Exit	Saves changes made and closes the BIOS setup. Options available: Yes, No.
Discard Changes and Exit	Discards changes made and exits the BIOS setup. Options available: Yes, No.
Save Changes	Saves changes done so far to any of the setup options. Options available: Yes, No.
Default Options	
Restore Defaults	Loads the default settings for all BIOS setup parameters. Setup Defaults are quite demanding in terms of resources consumption. If you are using low-speed memory chips or other kinds of low-performance components and you choose to load these settings, the system might not function properly. Options available: Yes, No.
Boot Override	Press [Enter] to configure the device as the boot-up drive.
Launch EFI Shell from filesystem device	Attempts to Launch EFI Shell application (Shell.efi) from one of the available file system devices.

5-10 BIOS Recovery

The system has an embedded recovery technique. In the event that the BIOS becomes corrupt the boot block can be used to restore the BIOS to a working state. To restore your BIOS, please follow the instructions listed below:

Recovery Instruction:

1. Copy the XXX.rom to USB diskette.
2. Setting BIOS Recovery jump to enabled status.
3. Boot into BIOS recovery.
4. Run Proceed with flash update.
5. BIOS updated.

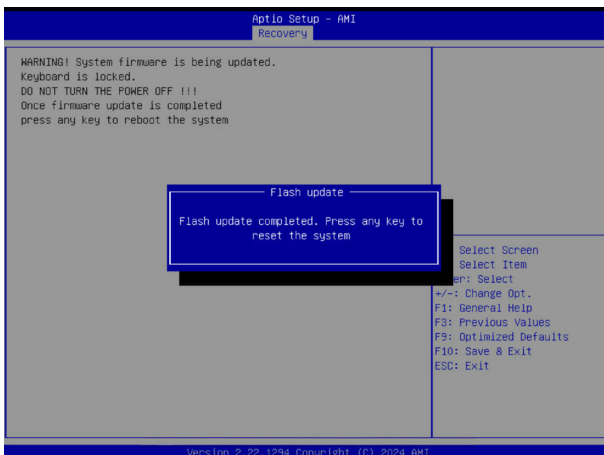

5-11 BIOS POST Beep code (AMI standard)

5-11-1 PEI Beep Codes

# of Beeps	Description
1	Memory not Installed.
1	Memory was installed twice (InstallPeiMemory routine in PEI Core called twice)
2	Recovery started
3	DXE IPL was not found
3	DXE Core Firmware Volume was not found
4	Recovery failed
4	S3 Resume failed
7	Reset PPI is not available

5-11-2 DXE Beep Codes

# of Beeps	Description
1	Invalid password
4	Some of the Architectural Protocols are not available
5	No Console Output Devices are found
5	No Console Input Devices are found
6	Flash update is failed
7	Reset protocol is not available
8	Platform PCI resource requirements cannot be met