

# **GIGABYTE™**

# **E252-P31**

Edge Server – Ampere® Altra® 2U Server System

## User Manual

Rev. 1.0

## **Copyright**

© 2022 GIGA-BYTE TECHNOLOGY CO., LTD. All rights reserved.

The trademarks mentioned in this manual are legally registered to their respective owners.

## **Disclaimer**

Information in this manual is protected by copyright laws and is the property of GIGABYTE. Changes to the specifications and features in this manual may be made by GIGABYTE without prior notice. No part of this manual may be reproduced, copied, translated, transmitted, or published in any form or by any means without GIGABYTE's prior written permission.

## **Documentation Classifications**

In order to assist in the use of this product, GIGABYTE provides the following types of documentation:

- User Manual: detailed information & steps about the installation, configuration and use of this product (e.g. motherboard, server barebones), covering hardware and BIOS.
- User Guide: detailed information about the installation & use of an add-on hardware or software component (e.g. BMC firmware, rail-kit) compatible with this product.
- Quick Installation Guide: a short guide with visual diagrams that you can reference easily for installation purposes of this product (e.g. motherboard, server barebones).

Please see the support section of the online product page to check the current availability of these documents.

## **For More Information**

For related product specifications, the latest firmware and software, and other information please visit our website at <http://www.gigabyte.com>



For GIGABYTE distributors and resellers, additional sales & marketing materials are available from our reseller portal: <http://reseller.b2b.gigabyte.com>

For further technical assistance, please contact your GIGABYTE representative or visit <https://esupport.gigabyte.com/> to create a new support ticket

For any general sales or marketing enquiries, you may also message GIGABYTE server directly by email: [server.grp@gigabyte.com](mailto:server.grp@gigabyte.com)

## Conventions

The following conventions are used in this user's guide:

	<b>NOTE!</b> Gives bits and pieces of additional information related to the current topic.
	<b>CAUTION!</b> Gives precautionary measures to avoid possible hardware or software problems.
	<b>WARNING!</b> Alerts you to any damage that might result from doing or not doing specific actions.

## Server Warnings and Cautions

Before installing a server, be sure that you understand the following warnings and cautions.



### **WARNING!**

**To reduce the risk of electric shock or damage to the equipment:**

- Do not disable the power cord grounding plug. The grounding plug is an important safety feature.
- Plug the power cord into a grounded (earthed) electrical outlet that is easily accessible at all times.
- Unplug all the power cords from the power supplies to disconnect power to the equipment.

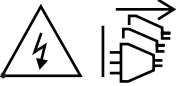

- Unplug the power cord from the power supply to disconnect power to the equipment.
- Do not route the power cord where it can be walked on or pinched by items placed against it. Pay particular attention to the plug, electrical outlet, and the point where the cord extends from the server.



### **WARNING!**

**To reduce the risk of personal injury from hot surfaces, allow the drives and the internal system components to cool before touching them.**



### **WARNING!**

**This server is equipped with high speed fans. Keep away from hazardous moving fan blades during servicing.**



### **WARNING!**

**This equipment is intended to be used in Restrict Access Location. The access can only be gained by Skilled person.**

**Only authorized by well trained professional person can access the restrict access location.**



### **CAUTION!**

- Do not operate the server for long periods with the access panel open or removed. Operating the server in this manner results in improper airflow and improper cooling that can lead to thermal damage.
- Danger of explosion if battery is incorrectly replaced.
- Replace only with the same or equivalent type recommended by the manufacturer.
- Dispose of used batteries according to the manufacturer's instructions.

## Electrostatic Discharge (ESD)



### CAUTION!

ESD CAN DAMAGE DRIVES, BOARDS, AND OTHER PARTS. WE RECOMMEND THAT YOU PERFORM ALL PROCEDURES AT AN ESD WORKSTATION. IF ONE IS NOT AVAILABLE, PROVIDE SOME ESD PROTECTION BY WEARING AN ANTI-STATIC WRIST STRAP ATTACHED TO CHASSIS GROUND -- ANY UNPAINTED METAL SURFACE -- ON YOUR SERVER WHEN HANDLING PARTS.

Always handle boards carefully. They can be extremely sensitive to ESD. Hold boards only by their edges without any component and pin touching. After removing a board from its protective wrapper or from the system, place the board component side up on a grounded, static free surface. Use a conductive foam pad if available but not the board wrapper. Do not slide board over any surface.

**System power on/off:** To remove power from system, you must remove the system from rack. Make sure the system is removed from the rack before opening the chassis, adding, or removing any non hot-plug components.

**Hazardous conditions, devices and cables:** Hazardous electrical conditions may be present on power, telephone, and communication cables. Turn off the system and disconnect the cables attached to the system before servicing it. Otherwise, personal injury or equipment damage can result.

**Electrostatic discharge (ESD) and ESD protection:** ESD can damage drives, boards, and other parts. We recommend that you perform all procedures in this chapter only at an ESD workstation. If one is not available, provide some ESD protection by wearing an antistatic wrist strap attached to chassis ground (any unpainted metal surface on the server) when handling parts.

**ESD and handling boards:** Always handle boards carefully. They can be extremely sensitive to electrostatic discharge (ESD). Hold boards only by their edges. After removing a board from its protective wrapper or from the system, place the board component side up on a grounded, static free surface. Use a conductive foam pad if available but not the board wrapper. Do not slide board over any surface.

**Installing or removing jumpers:** A jumper is a small plastic encased conductor that slips over two jumper pins. Some jumpers have a small tab on top that can be gripped with fingertips or with a pair of fine needle nosed pliers. If the jumpers do not have such a tab, take care when using needle nosed pliers to remove or install a jumper; grip the narrow sides of the jumper with the pliers, never the wide sides. Gripping the wide sides can damage the contacts inside the jumper, causing intermittent problems with the function controlled by that jumper. Take care to grip with, but not squeeze, the pliers or other tool used to remove a jumper, or the pins on the board may bend or break.

**CAUTION!**

Risk of explosion if battery is replaced incorrectly or with an incorrect type. Replace the battery only with the same or equivalent type recommended by the manufacturer. Dispose of used batteries according to the manufacturer's instructions.

# Table of Contents

Chapter 1	Hardware Installation .....	9
1-1	Installation Precautions .....	9
1-2	Product Specifications .....	10
1-3	System Block Diagram .....	13
Chapter 2	System Appearance .....	15
2-1	Front View .....	15
2-2	Rear View .....	16
2-3	Front Panel LED and Buttons .....	17
2-4	System LAN LEDs .....	18
2-5	Power Supply Unit (PSU) LED .....	19
2-6	Hard Disk Drive LEDs .....	20
Chapter 3	System Hardware Installation .....	21
3-1	Removing and Installing the Chassis Cover .....	22
3-2	Removing and Installing the Fan Duct .....	23
3-3	Removing and Installing the Heat Sink .....	24
3-4	Removing and Installing the CPU .....	25
3-5	Installing the Memory .....	26
3-5-1	Eight Channel Memory Configuration .....	26
3-5-2	Installing a Memory .....	27
3-5-3	DIMM Population Table .....	27
3-5-4	Altra Platform DDR4 Suggest Configuration Table .....	28
3-6	Installing the PCI Expansion Card .....	29
3-7	Removing and Installing the Hard Disk Drive .....	30
3-8	Replacing the Fan Assembly .....	31
3-9	Removing and Installing the Power Supply .....	32
3-10	Cable Routing .....	33
Chapter 4	Motherboard Components .....	37
4-1	Motherboard Components .....	37
4-2	Jumper Settings .....	39
Chapter 5	BIOS Setup .....	41
5-1	The Main Menu .....	43
5-2	Advanced Menu .....	45
5-2-1	Trusted Computing .....	46
5-2-2	ACPI Settings .....	47
5-2-3	General Watchdog .....	48

5-2-4	APEI Configuration .....	49
5-2-5	PCI Subsystem Settings .....	50
5-2-6	Info Report Configuration .....	57
5-2-7	USB Configuration .....	58
5-2-8	Network Stack .....	59
5-2-9	NVMe Configuration .....	60
5-2-10	Power Restore Configuration .....	61
5-2-11	Intel(R) I350 Gigabit Network Connection .....	62
5-2-12	MAC IPv4 Network Configuration .....	64
5-2-13	MAC IPv6 Network Configuration .....	65
5-3	Chipset Setup Menu .....	66
5-3-1	CPU Configuration .....	67
5-3-2	Memory Slot Information .....	68
5-3-3	RAS Configuration .....	71
5-3-4	PCIe Root Complex Configuration .....	72
5-4	Server Management Menu .....	73
5-4-1	System Event Log .....	74
5-4-2	BMC self test .....	75
5-4-3	View FRU Information .....	76
5-4-4	BMC Network Configuration .....	77
5-5	Security Menu .....	78
5-5-1	Secure Boot .....	79
5-6	Boot Menu .....	81
5-7	Save & Exit Menu .....	83
5-8	BIOS POST Beep code (AMI standard) .....	84
5-8-1	PEI Beep Codes .....	84
5-8-2	DXE Beep Codes .....	84



# Chapter 1 Hardware Installation

## 1-1 Installation Precautions

The motherboard/system contain numerous delicate electronic circuits and components which can become damaged as a result of electrostatic discharge (ESD). Prior to installation, carefully read the service guide and follow these procedures:

- Prior to installation, do not remove or break motherboard S/N (Serial Number) sticker or warranty sticker provided by your dealer. These stickers are required for warranty validation.
- Always remove the AC power by unplugging the power cord from the power outlet before installing or removing the motherboard or other hardware components.
- When connecting hardware components to the internal connectors on the motherboard, make sure they are connected tightly and securely.
- When handling the motherboard, avoid touching any metal leads or connectors.
- It is best to wear an electrostatic discharge (ESD) wrist strap when handling electronic components such as a motherboard, CPU or memory. If you do not have an ESD wrist strap, keep your hands dry and first touch a metal object to eliminate static electricity.
- Prior to installing the motherboard, please have it on top of an antistatic pad or within an electrostatic shielding container.
- Before unplugging the power supply cable from the motherboard, make sure the power supply has been turned off.
- Before turning on the power, make sure the power supply voltage has been set according to the local voltage standard.
- Before using the product, please verify that all cables and power connectors of your hardware components are connected.
- To prevent damage to the motherboard, do not allow screws to come in contact with the motherboard circuit or its components.
- Make sure there are no leftover screws or metal components placed on the motherboard or within the computer casing.
- Do not place the computer system on an uneven surface.
- Do not place the computer system in a high-temperature environment.
- Turning on the computer power during the installation process can lead to damage to system components as well as physical harm to the user.
- If you are uncertain about any installation steps or have a problem related to the use of the product, please consult a certified computer technician.





# 1-2 Product Specifications







**NOTE:**

We reserve the right to make any changes to the product specifications and product-related information without prior notice.

	<b>CPU</b>	<ul style="list-style-type: none"> <li>◆ Ampere® Altra® Max or Altra® Processor</li> <li>◆ Single processor, 7nm technology</li> <li>◆ Up to 128-core per processor</li> </ul>
	<b>Socket</b>	<ul style="list-style-type: none"> <li>◆ Single socket</li> <li>◆ LGA4926</li> </ul>
	<b>Chipset</b>	<ul style="list-style-type: none"> <li>◆ System on Chip</li> </ul>
	<b>Memory</b>	<ul style="list-style-type: none"> <li>◆ 16 x DIMM slots</li> <li>◆ DDR4 memory supported only</li> <li>◆ 8-Channel memory architecture</li> <li>◆ RDIMM modules up to 256GB supported</li> <li>◆ LRDIMM modules up to 256GB supported</li> <li>◆ Up to 4TB of memory capacity supported per processor</li> <li>◆ Memory speed: Up to 3200 MHz</li> </ul>
	<b>LAN</b>	<ul style="list-style-type: none"> <li>◆ 2 x 1GbE LAN ports (1 x Intel® I350-AM2)</li> <li>◆ 1 x 10/100/1000 Mbps management LAN</li> </ul>
	<b>Video</b>	<ul style="list-style-type: none"> <li>◆ Integrated in Aspeed® AST2500</li> <li>◆ 2D Video Graphic Adapter with PCIe bus interface</li> <li>◆ 1920x1200@60Hz 32bpp, DDR4 SDRAM</li> </ul>
	<b>Storage</b>	<ul style="list-style-type: none"> <li>◆ 6 x 2.5" SATA/SAS hot-swappable HDD/SSD bays from CRAO338 SAS RAID Card</li> </ul>
	<b>RAID</b>	<ul style="list-style-type: none"> <li>◆ RAID 0/ 1/ 1E/ 10</li> </ul>
	<b>Expansion Slot</b>	<p>Total 6 x low profile PCIe Gen4 expansion slots</p> <p>Slot_7: Disabled</p> <p>Slot_6: 1 x PCIe x16 (Gen4 x16 bus) slot</p> <p>Slot_5: 1 x PCIe x16 (Gen4 x8 bus) slot</p> <p>Slot_4: 1 x PCIe x16 (Gen4 x16 bus) slot</p> <p>Slot_3: 1 x PCIe x16 (Gen4 x8 bus) slot</p> <p>Slot_2: 1 x PCIe x8 (Gen4 x8 bus) slot</p> <p>Slot_1: 1 x PCIe x16 (Gen4 x8 bus) slot</p> <p>1 x OCP 2.0 mezzanine slot, occupied by CRAO338 SAS RAID Card</p> <p>2 x M.2 slots:</p> <ul style="list-style-type: none"> <li>◆ M-key</li> <li>◆ PCIe Gen4 x4</li> <li>◆ Supports NGFF-2242/2260/2280/22110 cards</li> </ul>

	Internal I/O	<ul style="list-style-type: none"> <li>◆ 2 x M.2 slots</li> <li>◆ 1 x USB 3.0 header</li> <li>◆ 1 x USB 2.0 header</li> <li>◆ 1 x TPM header</li> <li>◆ 1 x Front panel header</li> <li>◆ 1 x HDD back plane board header</li> <li>◆ 1 x PMBus connector</li> <li>◆ 1 x IPMB connector</li> <li>◆ 1 x Clear CMOS jumper</li> <li>◆ 1 x Buzzer</li> </ul>
	Front I/O	<ul style="list-style-type: none"> <li>◆ 3 x USB 3.0</li> <li>◆ 1 x VGA</li> <li>◆ 1 x Debug port</li> <li>◆ 2 x RJ45</li> <li>◆ 1 x MLAN</li> <li>◆ 1 x ID button with LED</li> </ul>
	Front Panel	<ul style="list-style-type: none"> <li>◆ 1 x USB 3.0 1 x Power button with LED</li> <li>◆ 1 x ID button with LED</li> <li>◆ 1 x Reset button</li> <li>◆ 1 x System status LED</li> <li>◆ 1 x HDD activity LED</li> <li>◆ 2 x LAN activity LEDs</li> </ul>
	Backplane I/O	<ul style="list-style-type: none"> <li>◆ Speed and bandwidth:</li> <li>◆ SAS 12Gb/s, SATA 6Gb/s</li> </ul>
	TPM	<ul style="list-style-type: none"> <li>◆ 1 x TPM header with SPI interface</li> <li>◆ Optional TPM2.0 kit: CTM010</li> </ul>

	Power Supply	<ul style="list-style-type: none"> <li>◆ Redundant 800W 80 PLUS Platinum hot-swap power supply</li> </ul>
	System Management	<ul style="list-style-type: none"> <li>◆ Aspeed® AST2500 management controller</li> <li>◆ GIGABYTE Management Console (AMI MegaRAC SP-X) web interface</li> <li>◆ Dashboard</li> <li>◆ HTML5 KVM</li> <li>◆ Sensor Monitor (Voltage, RPM, Temperature, CPU Status ...etc.)</li> <li>◆ Sensor Reading History Data</li> <li>◆ FRU Information</li> <li>◆ SEL Log in Linear Storage / Circular Storage Policy</li> <li>◆ Hardware Inventory</li> <li>◆ Fan Profile</li> <li>◆ System Firewall</li> <li>◆ Power Consumption</li> <li>◆ Power Control</li> <li>◆ LDAP / AD / RADIUS Support</li> <li>◆ Backup &amp; Restore Configuration</li> <li>◆ Remote BIOS/BMC/CPLD Update</li> <li>◆ Event Log Filter</li> <li>◆ User Management</li> <li>◆ Media Redirection Settings</li> <li>◆ PAM Order Settings</li> <li>◆ SSL Settings</li> <li>◆ SMTP Settings</li> </ul>
	Environment Ambient Temperature	<ul style="list-style-type: none"> <li>◆ Operating temperature: 10°C to 35°C</li> <li>◆ Non-operating temperature: -40°C to 60°C</li> </ul>
	Relative Humidity	<ul style="list-style-type: none"> <li>◆ Operating humidity: 8-80% (non-condensing)</li> <li>◆ Non-operating humidity: 20%-95% (non-condensing)</li> </ul>
	System Dimension	<ul style="list-style-type: none"> <li>◆ 2U</li> <li>◆ 439mm (W) x 86mm (H) x 449mm (D)</li> </ul>

# 1-3 System Block Diagram

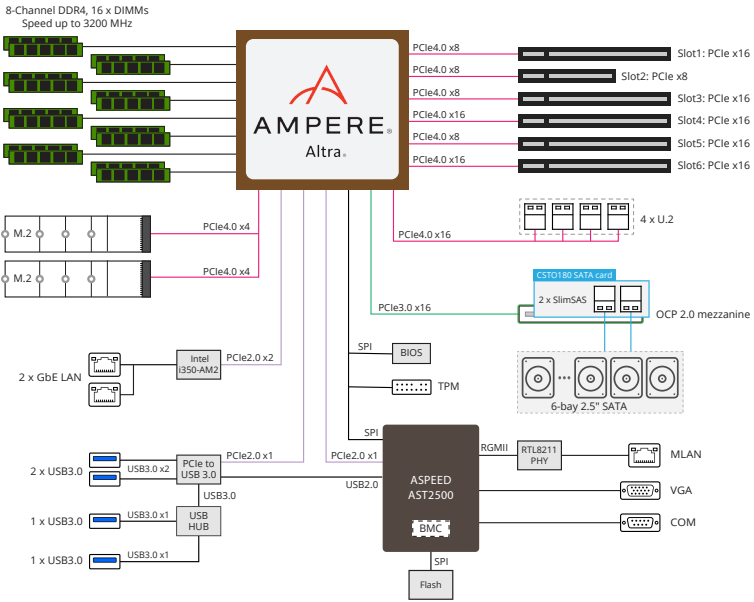

This page intentionally left blank

## Chapter 2 System Appearance

### 2-1 Front View

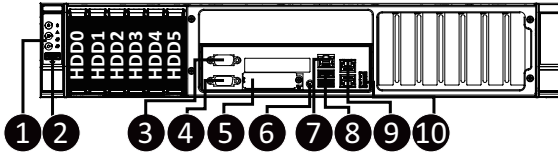

No.	Description
1.	Front Panel LEDs and Buttons
2.	USB 3.0 Port
3.	Serial Port
4.	VGA Port
5.	Mezzanine Slot (Option/COP2)
6.	ID Button with LED
7.	GbE Ethernet LAN Port x 2
8.	Server Management LAN Port
9.	ID Button with LED
10.	USB 3.0 Port



- Please Go to Chapter **2-3 Front Panel LED** and Buttons for detail description of function LEDs.

## 2-2 Rear View



No.	Description
1.	System Fan Cage #1
2.	System Fan Cage #2
3.	System Fan Cage #3
4.	System Fan Cage #4



## 2-3 Front Panel LED and Buttons

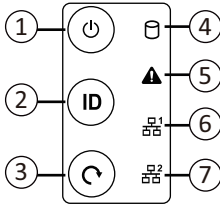

No.	Name	Color	Status	Description
1.	NMI button	Green	On	System is powered on
		Green	Blink	System is in ACPI S1 state (sleep mode)
		N/A	Off	<ul style="list-style-type: none"> <li>System is not powered on or in ACPI S5 state (power off)</li> <li>System is in ACPI S4 state (hibernate mode)</li> </ul>
2.	ID Button		Press the button to activate system identification	
3.	Reset Button		Press the button to reset the system.	
4.	HDD Status LED	Green	On	HDD locate
			Blink	HDD access
		Amber	On	HDD fault
		Green/ Amber	Blink	HDD rebuilding
		N/A	Off	No HDD access or no HDD fault.
5.	System Status LED	Green	Solid On	System is operating normally.
			Solid On	Critical condition, may indicate: System fan failure System temperature issue
		Amber	Blink	Non-critical condition, may indicate: Redundant power module failure Temperature and voltage issue Chassis intrusion
			N/A	Off
6/7.	LAN 1/2 Active/Link LEDs	Green	Solid On	Link between system and network or no access.
		Green	Blink	Data transmission or receiving is occurring
		N/A	Off	No data transmission or receiving is occurring

## 2-4 System LAN LEDs

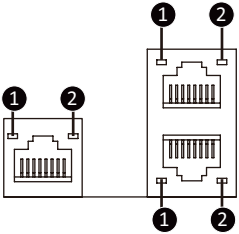

No.	Name	Color	Status	Description
1.	1GbE Speed LED	Yellow	On	1 Gbps data rate
		Green	On	100 Mbps data rate
		N/A	Off	10 Mbps data rate
2.	1GbE Link/ Activity LED	Green	On	Link between system and network or no access
			Blink	Data transmission or receiving is occurring
		N/A	Off	No data transmission or receiving is occurring

## 2-5 Power Supply Unit (PSU) LED

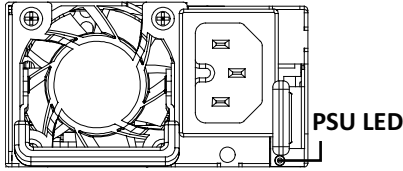

State	Description
OFF	Indicates no AC power to all power supplies
1Hz Blink GREEN	Indicates AC present/ only standby on/ Cold redundant mode
2Hz Blink GREEN	Power supply firmware updating mode
Amber	Indicates power supply critical event causing shut down: failure, OCP, OVP, Fan Fail, UVP
	Indicates AC cord unplugged or AC power lost; with a second power supply in parallel still with AC input power.
1Hz Blink Amber	Indicates AC cord unplugged or AC power lost; with a second power supply in parallel still with AC input power.
1Hz Blink Amber/Green Alternative	Indicates power supply warning events where the power supply continues to operate: high temp, high power, high current, slow fan.

## 2-6 Hard Disk Drive LEDs

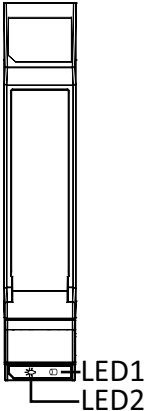

	LED1 (Green)	LED1 (Red)	LED2 (Blue)
Indicator	Drive activity	Drive locate/fault/rebuild	Drive present
Behavior	BLINK: Drive is active ON or OFF : Idle (depend on drive)	ON : Fault BLINK 4Hz : Locate BLINK 1Hz : Rebuild	ON : Drive is plugged in OFF : No drive

## Chapter 3 System Hardware Installation



### Pre-installation Instructions

Computer components and electronic circuit boards can be damaged by electrostatic discharge. Working on computers that are still connected to a power supply can be extremely dangerous. Follow the simple guidelines below to avoid damage to your computer or injury to yourself.

- Always disconnect the computer from the power outlet whenever you are working inside the computer case.
- If possible, wear a grounded wrist strap when you are working inside the computer case. Alternatively, discharge any static electricity by touching the bare metal system of the computer case, or the bare metal body of any other grounded appliance.
- Hold electronic circuit boards by the edges only. Do not touch the components on the board unless it is necessary to do so. Do not flex or stress the circuit board.
- Leave all components inside the static-proof packaging until you are ready to use the component for the installation.

### 3-1 Removing and Installing the Chassis Cover



Before you remove or install the system cover

- Make sure the system is not turned on or connected to AC power.

**Follow these instructions to remove the chassis cover:**

1. Remove the screw securing the chassis side cover.
2. Slide the chassis cover to the rear of the system and then remove the cover in the direction of the arrow.
3. To reinstall the chassis cover follow steps 1-4 in reverse order.

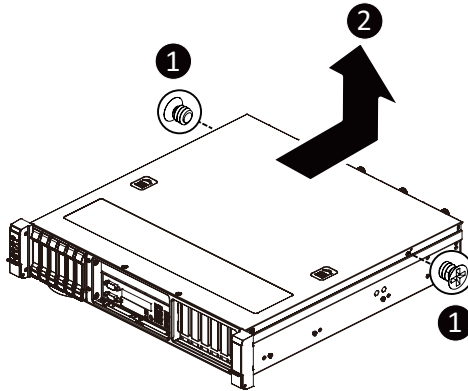

## 3-2 Removing and Installing the Fan Duct

Follow these instructions to remove the CPU and GPU fan ducts:

1. Lift up to remove the fan duct.
2. To reinstall the fan duct, align the fan duct with the guiding groove. Push down the fan duct until it is firmly seated on the system.

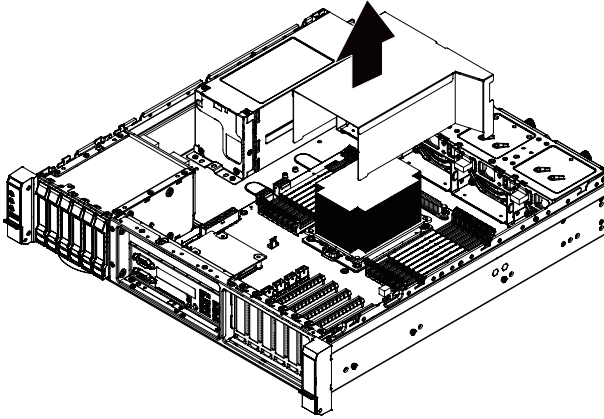

### 3-3 Removing and Installing the Heat Sink



Read the following guidelines before you begin to install the heat sink:

- Always turn off the computer and unplug the power cord from the power outlet before installing the heat sink to prevent hardware damage.
- Unplug all cables from the power outlets.
- Disconnect all telecommunication cables from their ports.
- Place the system unit on a flat and stable surface.
- Open the system according to the instructions.



#### **WARNING!**

Failure to turn off the server before you start installing components may cause serious damage. Do not attempt the procedures described in the following sections unless you are a qualified service technician.

#### **Follow these instructions to install the heat sink:**

1. Loosen the screws securing the heat sink in place in reverse order (4→3→2→1).
2. Lift and remove the heat sink from the system.
3. To install the heat sink, reverse steps 1-2 while ensuring that you tighten the captive screws in sequential order (1→2→3→4) as seen in the image below.

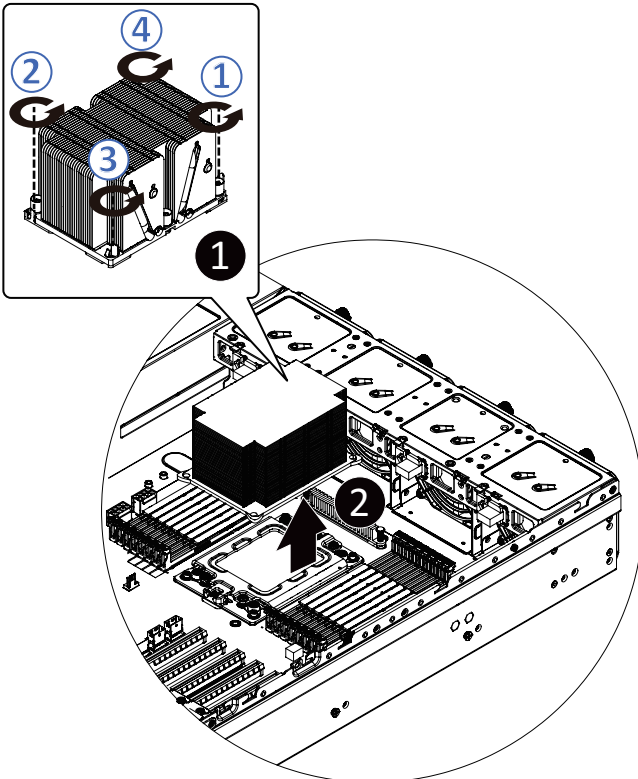



## 3-4 Removing and Installing the CPU



Read the following guidelines before you begin to install the CPU:

- Make sure that the motherboard supports the CPU.
- Always turn off the computer and unplug the power cord from the power outlet before installing the CPU to prevent hardware damage.
- Unplug all cables from the power outlets.
- Disconnect all telecommunication cables from their ports.
- Place the system unit on a flat and stable surface.
- Open the system according to the instructions.



### WARNING!

Failure to properly turn off the server before you start installing components may cause serious damage. Do not attempt the procedures described in the following sections unless you are a qualified service technician.

### Follow these instructions to install the CPU:

1. Loosen the three captive screws securing the CPU cover in sequential order (1→2→3→4→5).
2. Flip open the CPU cover.
3. Remove the CPU carrier from the CPU frame using the handle on the CPU carrier.
4. Install the CPU into place in the CPU socket.
5. Flip the CPU cover into place over the CPU socket.
6. Tighten the CPU cover screws in sequential order (1→2→3→4→5) to secure the CPU cover in place.
7. To remove the CPUs, follow steps 1-6 in reverse order.

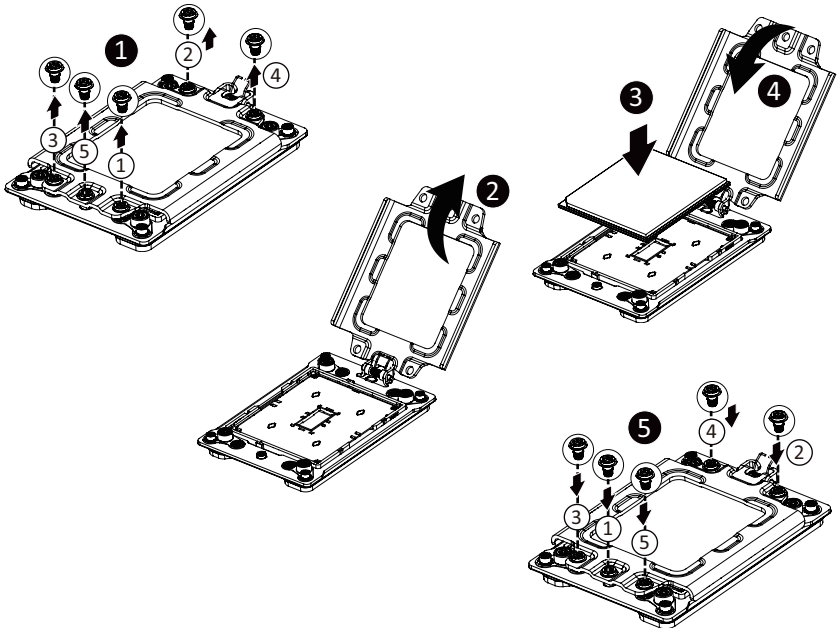

### 3-5 Installing the Memory



Read the following guidelines before you begin to install the memory:

- Make sure that the motherboard supports the memory. It is recommended that memory of the same capacity, brand, speed, and chips be used.
- Always turn off the computer and unplug the power cord from the power outlet before installing the memory to prevent hardware damage.
- Memory modules have a foolproof design. A memory module can be installed in only one direction. If you are unable to insert the memory, switch the direction.

#### 3-5-1 Eight Channel Memory Configuration

This motherboard provides 16 DDR4 memory sockets and supports Eight Channel Technology. After the memory is installed, the BIOS will automatically detect the specifications and capacity of the memory. Enabling Four Channel memory mode will be four times of the original memory bandwidth.

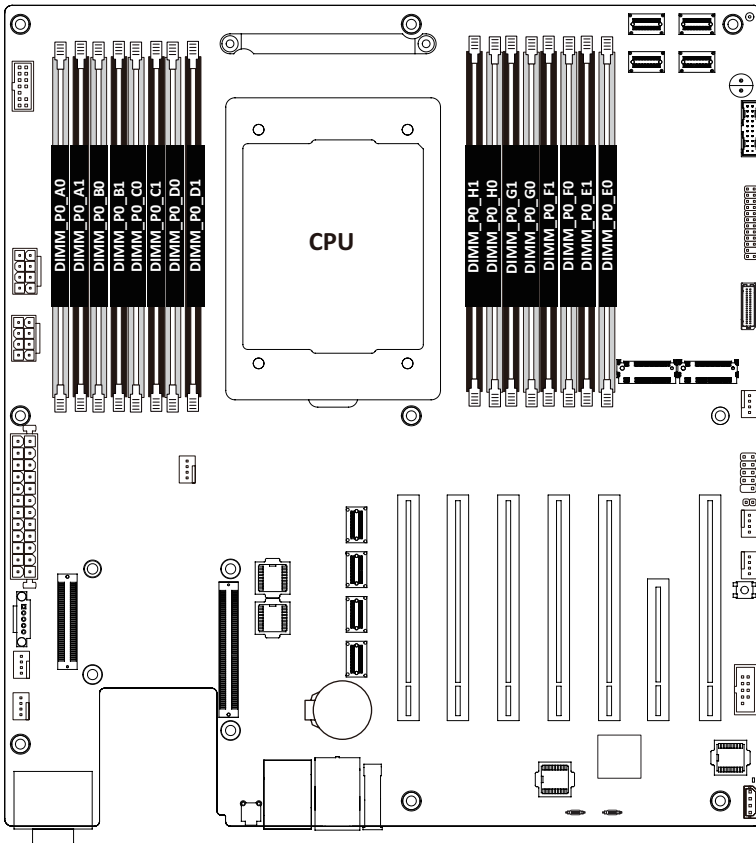

### 3-5-2 Installing a Memory



Before installing a memory module, make sure to turn off the computer and unplug the power cord from the power outlet to prevent damage to the memory module.

Be sure to install DDR4 DIMMs on this motherboard.

Follow these instructions to install the Memory:

1. Insert the DIMM memory module vertically into the DIMM slot, and push it down.
2. Close the plastic clip at both edges of the DIMM slots to lock the DIMM module.
3. Reverse the installation steps when you want to remove the DIMM module.

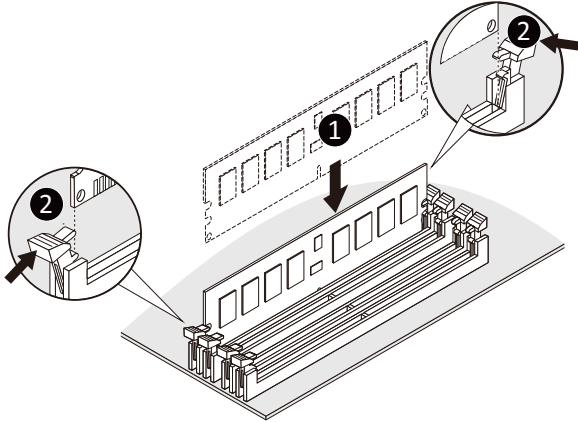

### 3-5-3 DIMM Population Table

Type	Ranks Per DIMM and Data Width	DIMM Capacity (GB)	Speed (MT/s); Voltage (V) Slot Per Channel (SPC) DIMM Per Channel (DPC)		
			1 Slot per Channel	2 Slots per Channel	
		DIMM Density	1DPC	1DPC	2DPC
RDIMM	SRx4	16GB	3200	1.2V	1.2V
RDIMM	DRx8	16GB		1.2V	

### 3-5-4 Altra Platform DDR4 Suggest Configuration Table

Channels Used	Channels used ( ✓ = Memory Installed)							
	DIMM_PO_E0	DIMM_PO_F0	DIMM_PO_G0	DIMM_PO_H0	DIMM_PO_D0	DIMM_PO_C0	DIMM_PO_B0	DIMM_PO_A0
1								✓
1	✓							
2	✓							✓
4	✓	✓					✓	✓
6	✓	✓	✓			✓	✓	✓
8	✓	✓	✓	✓	✓	✓	✓	✓

Channels Used	Channels used ( ✓ = Memory Installed)							
	DIMM_PO_E0 DIMM_PO_E1	DIMM_PO_F0 DIMM_PO_F1	DIMM_PO_G0 DIMM_PO_G1	DIMM_PO_H0 DIMM_PO_H1	DIMM_PO_D0 DIMM_PO_D1	DIMM_PO_C0 DIMM_PO_C1	DIMM_PO_B0 DIMM_PO_B1	DIMM_PO_A0 DIMM_PO_A1
1								✓ ✓
1	✓ ✓							
2	✓ ✓							✓ ✓
4	✓ ✓	✓ ✓					✓ ✓	✓ ✓
6	✓ ✓	✓ ✓	✓ ✓			✓ ✓	✓ ✓	✓ ✓
8	✓ ✓	✓ ✓	✓ ✓	✓ ✓	✓ ✓	✓ ✓	✓ ✓	✓ ✓

### 1 DIMM Per Channel

Channels Used	Channels used ( ✓ = Memory Installed)							
	DIMM_PO_E0	DIMM_PO_F0	DIMM_PO_G0	DIMM_PO_H0	DIMM_PO_D0	DIMM_PO_C0	DIMM_PO_B0	DIMM_PO_A0
8	✓	✓	✓	✓	✓	✓	✓	✓

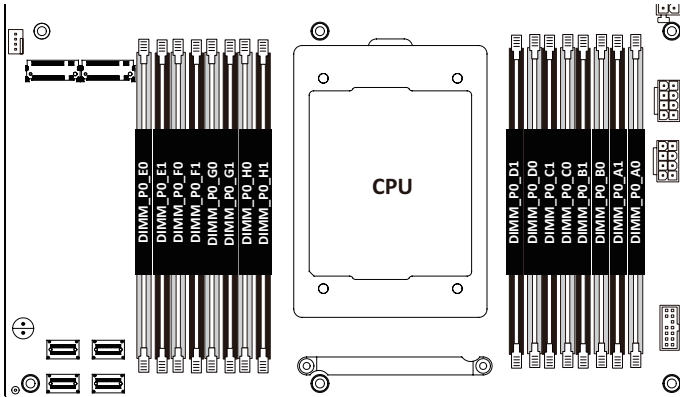

## 3-6 Installing the PCI Expansion Card



Before you install the GPU card:

- Voltages can be present within the server whenever an AC power source is connected. This voltage is present even when the main power switch is in the off position. Ensure that the system is powered-down and all power sources have been disconnected from the server prior to installing a PCI card.

Failure to observe these warnings could result in personal injury or damage to equipment.



- The PCI riser assembly does not include a riser card or any cabling as standard. To install a PCIe card, a riser card must be installed.

### Follow these instructions to PCI Expansion card:

1. Remove the screw securing the riser bracket. Lift up the riser bracket out of system.
2. Loosen and remove the screw securing the slot cover from riser bracket.
3. Orient the PCIe card with the riser guide slot and push in the direction of the arrow until the PCIe card sits in the PCIe card connector.

**NOTE:** Some riser brackets allow for single or multiple PCIe cards. Repeat steps 4-5 as necessary.

4. Secure the PCIe card with the screw.
5. Reverse steps 1-3 to install the riser bracket.

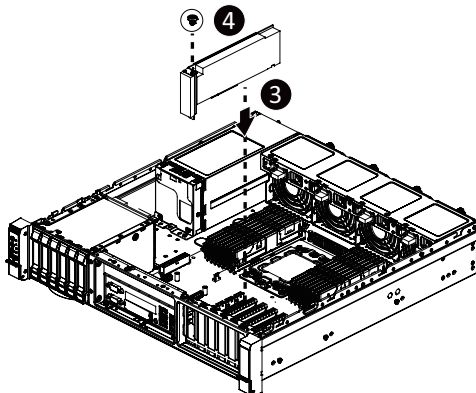
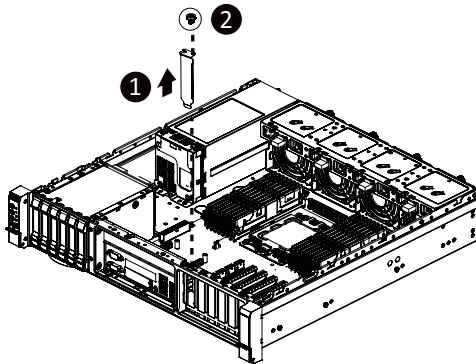

### 3-7 Removing and Installing the Hard Disk Drive



Read the following guidelines before you begin to install the hard disk drive:

- Take note of the HDD tray orientation before sliding it out.
- The tray will not fit back into the bay if it is inserted incorrectly.
- Make sure that the hard disk drive is connected to the connector on the backplane.

**Follow these instructions to install a 2.5" hard disk drive:**

1. Press the release button.
2. Extend the locking lever.
3. Pull the locking lever in the direction indicated to remove the HDD tray.
4. Align the hard disk drive with the positioning stud on the HDD tray.
5. Slide the hard disk drive into the HDD tray.
6. Reinsert the HDD tray into the slot and close the locking lever.

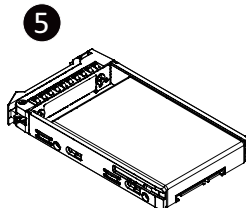
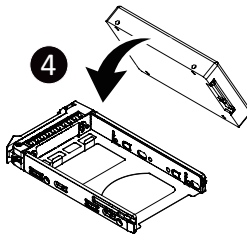
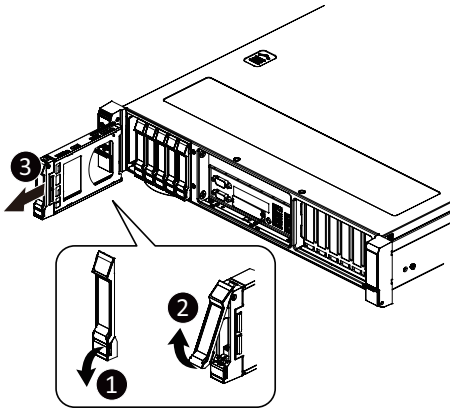

## 3-8 Replacing the Fan Assembly



- Voltages can be present within the server whenever an AC power source is connected. This voltage is present even when the main power switch is in the off position. Ensure that the system is powered-down and all power sources have been disconnected from the server prior to replacing a system fan.

Failure to observe these warnings could result in personal injury or damage to equipment.

### Follow these instructions to replace a fan assembly:

1. Loosen the thumbscrew on the fan assembly.
2. Remove the fan assembly from the chassis.
3. Reverse the previous steps to install the replacement fan assembly.

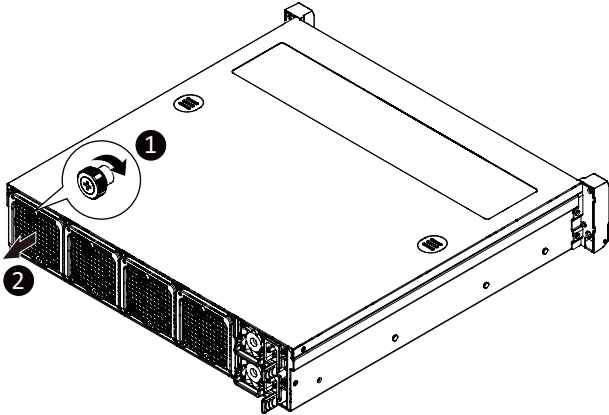

### 3-9 Removing and Installing the Power Supply

Follow these instructions to replace the power supply:

1. Flip up and then grasp the power supply handle.
2. Pull out the power supply unit using the handle.
3. Insert the replacement power supply unit firmly into the chassis. Connect the AC power cord to the replacement power supply.
4. Repeat steps 1-4 for replacement of the second power supply.

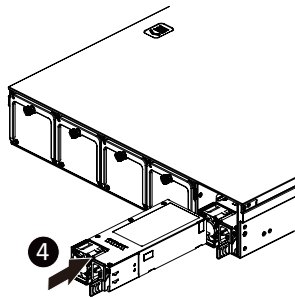
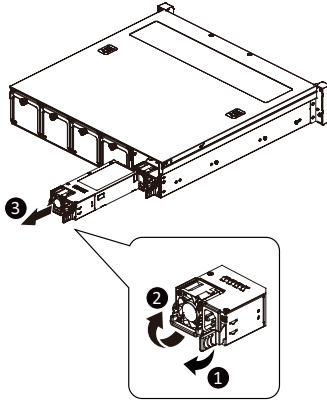



# 3-10 Cable Routing

## Front Panel LEDs and Buttons Cable

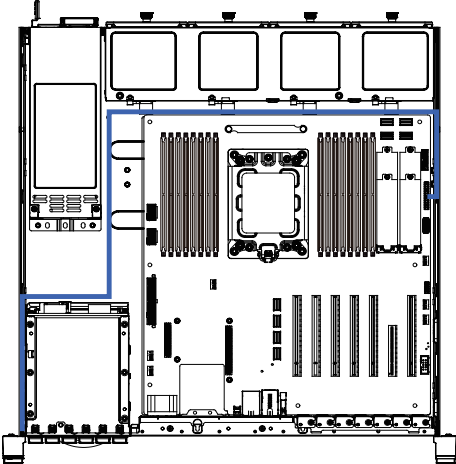

## Front Panel USB 3.0 Ports Cable

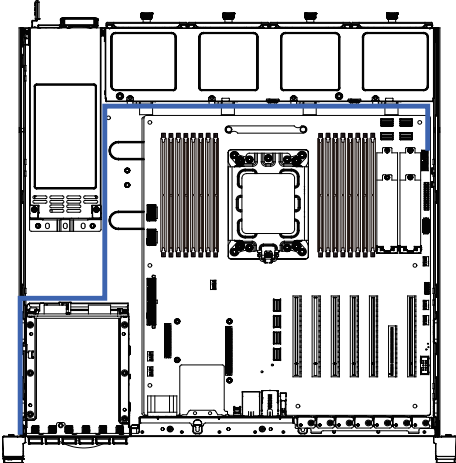

### HDD Backplane Board Signal Cable

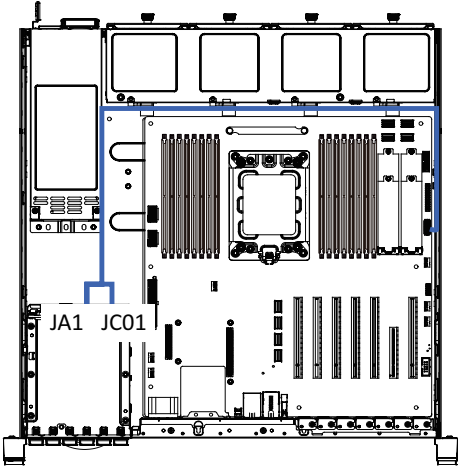

### HDD Backplane Board Power Cable

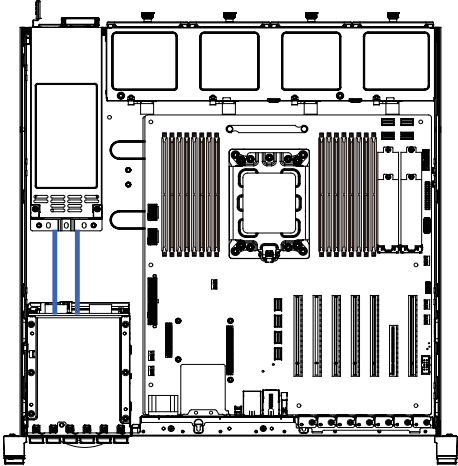

### 12V Power Cable

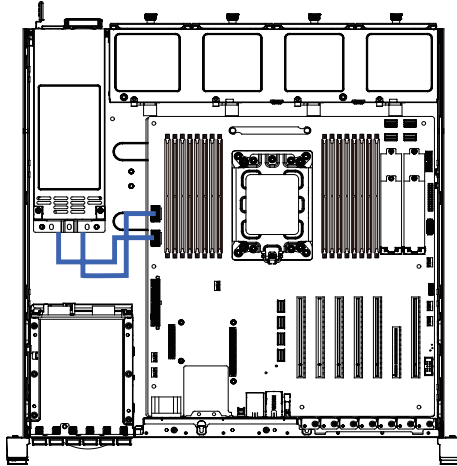

### System Power Cable

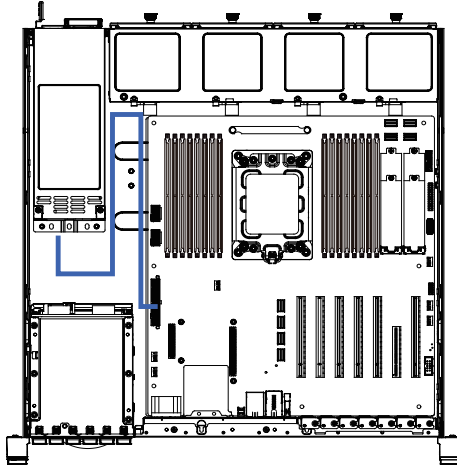

CSTO180 Cable

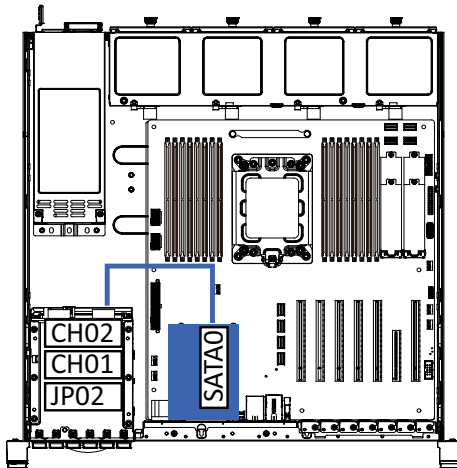
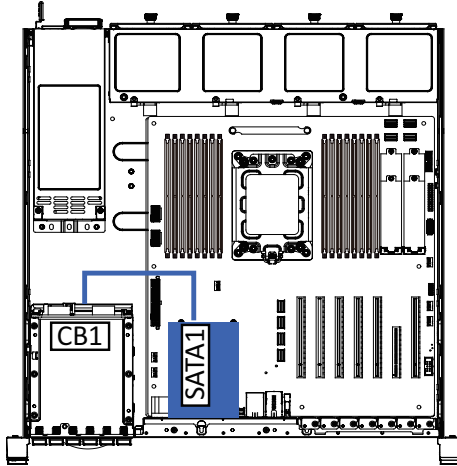

# Chapter 4 Motherboard Components

## 4-1 Motherboard Components

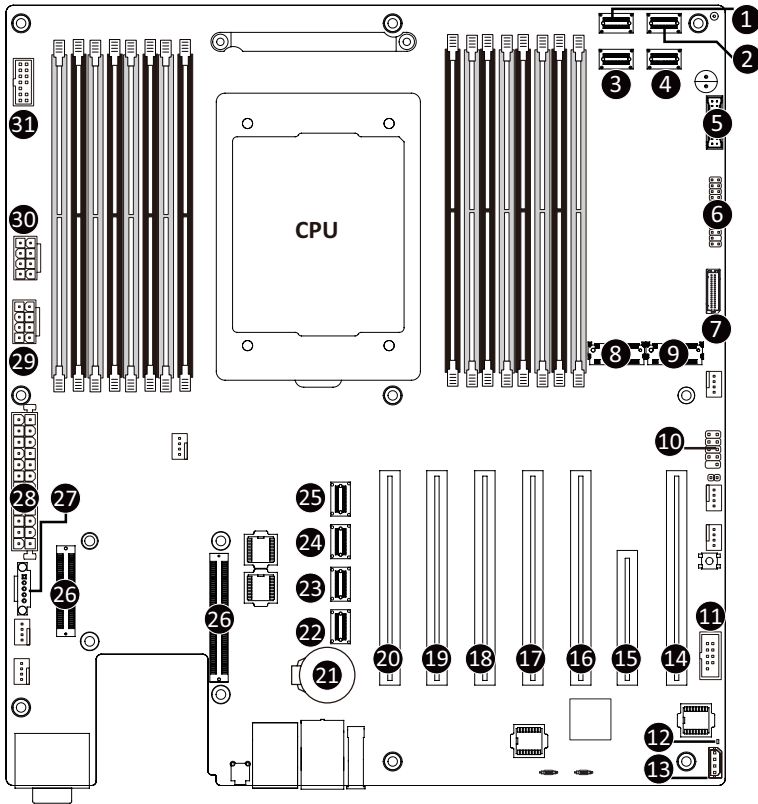

Item	Description
1	SlimLine SAS Connector (U2_2)
2	SlimLine SAS Connector (U2_3)
3	SlimLine SAS Connector (U2_1)
4	SlimLine SAS Connector (U2_0)
5	Front panel USB 3.0 Connector
6	Front Panel Connector
7	HDD Back Plane Board Connector
8	M.2 Connector (PCIe4 x4, NGFF-22110)
9	M.2 Connector (PCIe4 x4, NGFF-22110)

10	USB 2.0 Connector
11	Serial Port Cable Connector
12	BMC Firmware Readiness LED
13	IPMB Connector
14	PCIe x16 Slot #1 (x8 Signal)
15	PCIe x8 Slot #2 (x8 Signal)
16	PCIe x16 Slot #3 (x8 Signal)
17	PCIe x16 Slot #4 (x16 Signal)
18	PCIe x16 Slot #5 (x8 Signal)
19	PCIe x16 Slot #6 (x8 Signal)
20	PCIe x16 Slot #7 (x16 Signal)
21	System Battery
22	SlimLine SAS Connector (SLINK0)
23	SlimLine SAS Connector (SLINK1)
24	SlimLine SAS Connector (SLINK2)
25	SlimLine SAS Connector (SLINK3)
26	OCP Mezzanine Connector
27	PMBus Connector
28	2 x 13 Pin Power Connector
29	2 x 4 Pin 12V Power Connector
30	2 x 4 Pin 12V Power Connector
31	TPM Module Connector

# 4-2 Jumper Settings

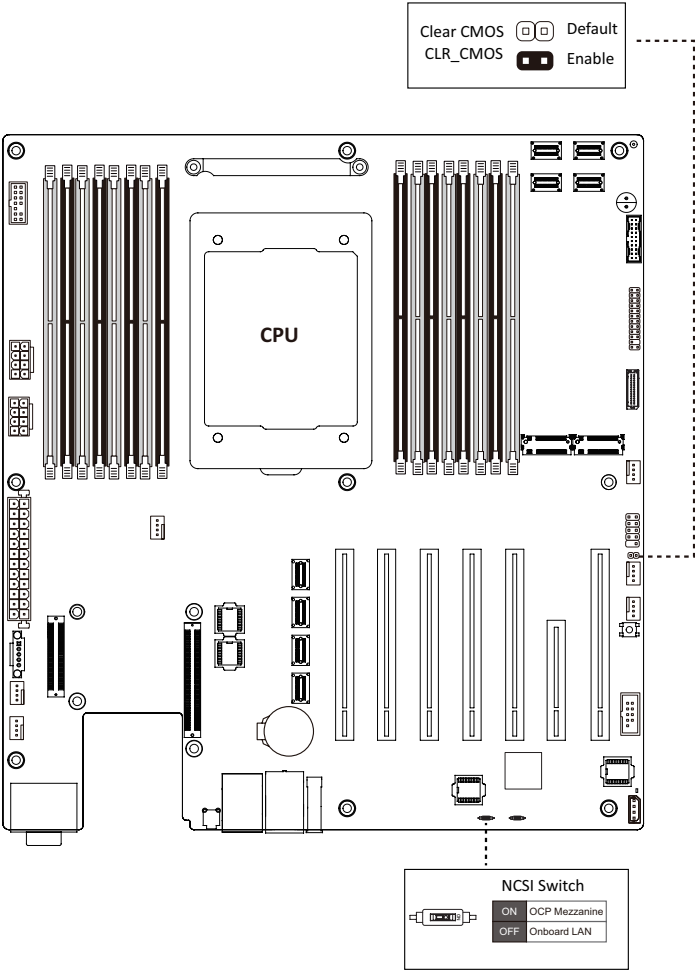

This page intentionally left blank



## Chapter 5 BIOS Setup

BIOS (Basic Input and Output System) records hardware parameters of the system in the EFI on the motherboard. Its major functions include conducting the Power-On Self-Test (POST) during system startup, saving system parameters and loading operating system, etc. BIOS includes a BIOS Setup program that allows the user to modify basic system configuration settings or to activate certain system features. When the power is turned off, the battery on the motherboard supplies the necessary power to the CMOS to keep the configuration values in the CMOS.

To access the BIOS Setup program, press the <DEL> key during the POST when the power is turned on.



- BIOS flashing is potentially risky, if you do not encounter problems of using the current BIOS version, it is recommended that you don't flash the BIOS. To flash the BIOS, do it with caution. Inadequate BIOS flashing may result in system malfunction.
- It is recommended that you not alter the default settings (unless you need to) to prevent system instability or other unexpected results. Inadequately altering the settings may result in system's failure to boot. If this occurs, try to clear the CMOS values and reset the board to default values. (Refer to the **Exit** section in this chapter or introductions of the battery/clearing CMOS jumper in Chapter 1 for how to clear the CMOS values.)

### BIOS Setup Program Function Keys

<<-><->>	Move the selection bar to select the screen
<↑><↓>	Move the selection bar to select an item
<+>	Increase the numeric value or make changes
<->	Decrease the numeric value or make changes
<Enter>	Execute command or enter the submenu
<Esc>	Main Menu: Exit the BIOS Setup program Submenus: Exit current submenu
<F1>	Show descriptions of general help
<F3>	Restore the previous BIOS settings for the current submenus
<F9>	Load the Optimized BIOS default settings for the current submenus
<F10>	Save all the changes and exit the BIOS Setup program

■ **Main**

This setup page includes all the items in standard compatible BIOS.

■ **Advanced**

This setup page includes all the items of AMI BIOS special enhanced features.

(ex: Auto detect fan and temperature status, automatically configure hard disk parameters.)

■ **Chipset**

This setup page includes all the submenu options for configuring the function of processor, network, North Bridge, South Bridge, and System event logs.

■ **Server Management**

Server additional features enabled/disabled setup menus.

■ **Security**

Change, set, or disable supervisor and user password. Configuration supervisor password allows you to restrict access to the system and BIOS Setup.

A supervisor password allows you to make changes in BIOS Setup.

A user password only allows you to view the BIOS settings but not to make changes.

■ **Boot**

This setup page provides items for configuration of boot sequence.

■ **Save & Exit**

Save all the changes made in the BIOS Setup program to the CMOS and exit BIOS Setup. (Pressing <F10> can also carry out this task.)

Abandon all changes and the previous settings remain in effect. Pressing <Y> to the confirmation message will exit BIOS Setup. (Pressing <Esc> can also carry out this task.)

# 5-1 The Main Menu

Once you enter the BIOS Setup program, the Main Menu (as shown below) appears on the screen. Use arrow keys to move among the items and press <Enter> to accept or enter other sub-menu.

## Main Menu Help

The on-screen description of a highlighted setup option is displayed on the bottom line of the Main Menu.

## Submenu Help

While in a submenu, press <F1> to display a help screen (General Help) of function keys available for the menu. Press <Esc> to exit the help screen. Help for each item is in the Item Help block on the right side of the submenu.



- When the system is not stable as usual, select the **Restore Defaults** item to set your system to its defaults.
- The BIOS Setup menus described in this chapter are for reference only and may differ by BIOS version.

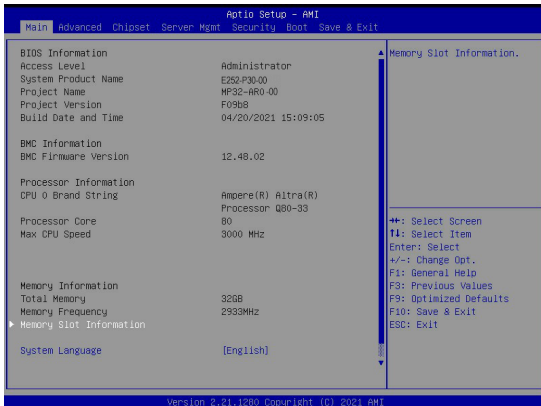

Parameter	Description
BIOS Information	
Access Level	Display the privileges level information.
System Project Name	Displays the system project name information.
Project Name	Displays the motherboard project name information.
Project Version	Displays version number of the BIOS setup utility.
Build Date and Time	Displays the date and time when the BIOS setup utility was created.
BMC Information	
BMC Firmware Version	Displays version number of the BIOS setup utility.
Processor Information	
CPU0 Brand String	Displays the technical specifications for the installed processor.
Processor Core	
Max CPU Speed	
Memory Information	
Total Memory	Displays the technical specifications for the installed memory.
Memory Frequency	
Memory Slot Information	Press [Enter] to view installed memory slot information.
System Language	Option: English
System Date	Sets the date following the weekday-month-day-year format.
System Time	Sets the system time following the hour-minute-second format.

## 5-2 Advanced Menu

The Advanced menu display submenu options for configuring the function of various hardware components. Select a submenu item, then press [Enter] to access the related submenu screen.

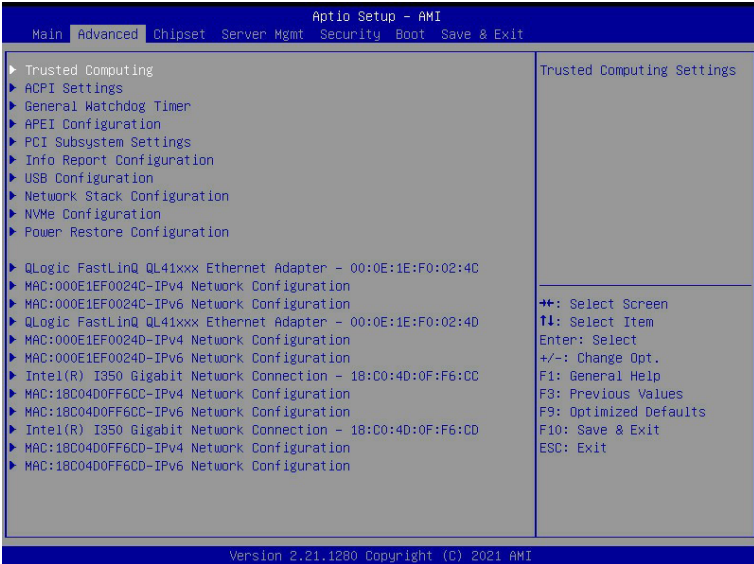

## 5-2-1 Trusted Computing

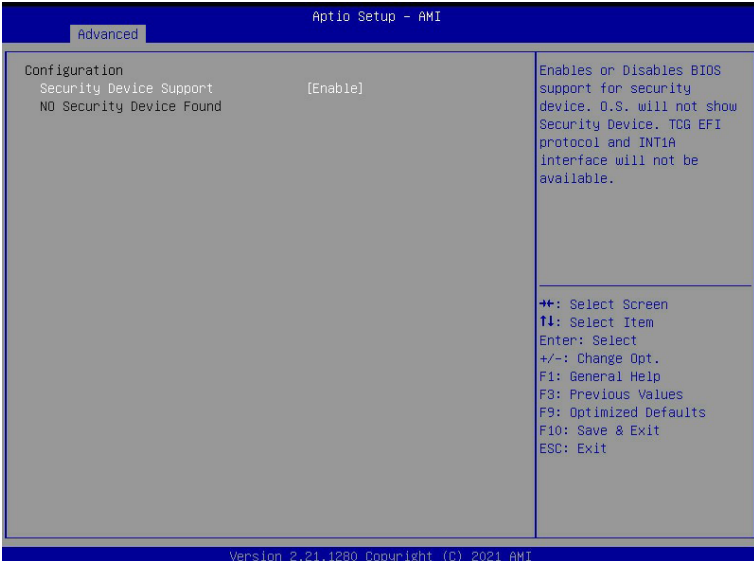

Parameter	Description
Configuration	
Security Device Support	Select Enabled to activate TPM support feature. Options available: Enable/Disable. Default setting is <b>Enable</b> .

## 5-2-2 ACPI Settings

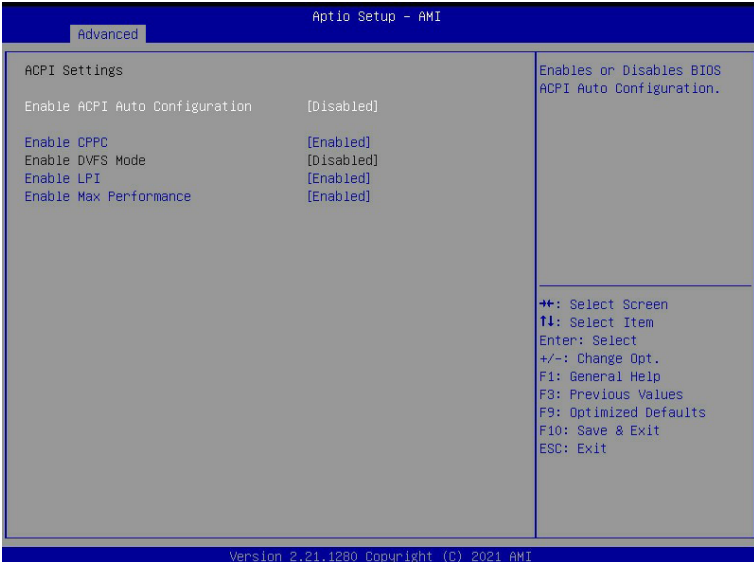

Parameter	Description
ACPI Settings	
Enable ACPI Auto Configuration	Enable or disable BIOS ACPI auto configuration. Options available: Enabled/Disabled. Default setting is <b>Enabled</b> .
Enable CPPC	Enable or disable CPPC. Options available: Enable/Disable. Default setting is <b>Enabled</b> .
Enable DVFS Mode	Options available: Enabled/Disabled. Default setting is <b>Disabled</b> .
Enable LPI	Options available: Enabled/Disabled. Default setting is <b>Enabled</b> .
Enable Max Performance	Options available: Enabled/Disabled. Default setting is <b>Enabled</b> .

### 5-2-3 General Watchdog



Parameter	Description
General Watchdog Timer	
Secure Watchdog Timeout	Timeout when SCP will reset system if it doesn't receive response from ARMv8. Options available: 5 minutes/6 minutes/10 minutes/15 minutes/25 minutes. Default setting is <b>5 minutes</b> .
BIOS Watchdog Timeout	Options available: 5 minutes/6 minutes/10 minutes/15 minutes/25 minutes. Default setting is <b>5 minutes</b> .
OS Watchdog Timeout	Timeout when boot OS. Options available: Disable/3 minutes/4 minutes/5 minutes/6 minutes/10 minutes/15 minutes/20 minutes. Default setting is <b>Disable</b> .



## 5-2-4 APEI Configuration

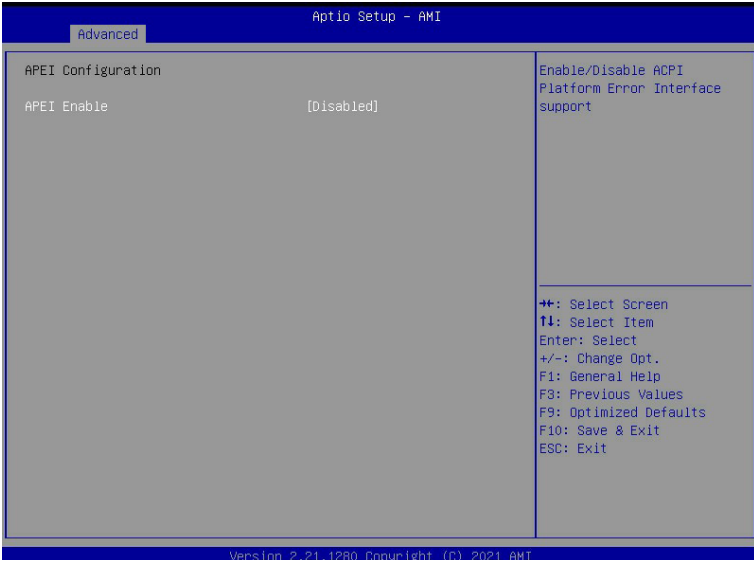

Parameter	Description
APEI Configuration	
APEI Enable	Enable/Disable ACPI Platform Error Interface support. Options available: Enabled/Disabled. Default setting is <b>Disabled</b> .

## 5-2-5 PCI Subsystem Settings

Aptio Setup - AMI	
Advanced	
<p>AMI PCI Driver Version : A5.01.20</p> <p>PCI Settings Common for all Devices:            Above 4G Decoding [Enabled]            SR-IOV Support [Disabled]</p> <p>Change Settings of the Following PCI Devices:</p> <ul style="list-style-type: none"> <li>▶ Slot # 8 Occupied [Network Controller]</li> <li>▶ OnBoard Device [Network Controller]</li> <li>▶ OnBoard Device [Display Controller]</li> <li>▶ OnBoard Device [Bridge Device]</li> <li>▶ OnBoard Device [Serial Bus Controller]</li> </ul> <p>WARNING: Changing PCI Device(s) settings may have unwanted side effects! System may HANG! PROCEED WITH CAUTION.</p>	<p>Globally Enables or Disables 64bit capable Devices to be Decoded in Above 4G Address Space (Only if System Supports 64 bit PCI Decoding).</p> <hr/> <p>++: Select Screen            ↑↓: Select Item            Enter: Select            +/-: Change Opt.            F1: General Help            F3: Previous Values            F9: Optimized Defaults            F10: Save &amp; Exit            ESC: Exit</p>
Version 2.21.1280 Copyright (C) 2021 AMI	

Aptio Setup - AMI	
Advanced	
<p>PCI Express GEN 1 Settings</p> <p>PCI Express Device Register Settings</p> <ul style="list-style-type: none"> <li>Relaxed Ordering [Enabled]</li> <li>Extended Tag [Disabled]</li> <li>No Snoop [Disabled]</li> <li>Maximum Payload [Auto]</li> <li>Maximum Read Request [Auto]</li> </ul> <p>PCI Express Link Register Settings</p> <ul style="list-style-type: none"> <li>Extended Synch [Disabled]</li> <li>Clock Power Management [Disabled]</li> <li>Link Training Retry [5]</li> <li>Link Training Timeout (US) 1000</li> <li>Disable Empty Links [Disabled]</li> </ul> <p>WARNING: Enabling ASPM may cause some PCI-E devices to fail!</p>	<p>Enables or Disables PCI Express Device Relaxed Ordering.</p> <hr/> <p>++: Select Screen            ↑↓: Select Item            Enter: Select            +/-: Change Opt.            F1: General Help            F3: Previous Values            F9: Optimized Defaults            F10: Save &amp; Exit            ESC: Exit</p>
Version 2.21.1280 Copyright (C) 2021 AMI	

Parameter	Description
AMI PCI Bus Driver Version	Displays the AMI PCI Bus Driver version information.
Above 4G Decoding	Enable/Disable memory mapped I/O to 4GB or greater address space (Above 4G Decoding). Options available: Enabled/Disabled. Default setting is <b>Disabled</b> .
SR-IOV Support	If the system has SR-IOV capable PCIe devices, this item Enable/Disable Single Root IO Virtualization Support. Options available: Enabled/Disabled. Default setting is <b>Enabled</b> .
Change Settings of the Following PCI Devices	
Slot #8 Occupied Onboard Device_#	<ul style="list-style-type: none"> <li>◆ PCI Latency Timer <ul style="list-style-type: none"> <li>– Value to be programmed onto PCI Latency Timer Register.</li> </ul> Options available: 32/64/96/128/160/192/224/248 PCI Bus Clocks. Default setting is <b>32 PCI Bus Clocks</b>. </li> <li>◆ PCI-X Latency Timer <ul style="list-style-type: none"> <li>– Value to be programmed onto PCI Latency Timer Register.</li> </ul> Options available: 32/64/96/128/160/192/224/248 PCI Bus Clocks. Default setting is <b>64 PCI Bus Clocks</b>. </li> <li>◆ VGA Palette Snoop <ul style="list-style-type: none"> <li>– Enable or disable VGA Palette Registers Snooping.</li> </ul> Options available: Enabled/Disabled. Default setting is <b>Disabled</b>. </li> <li>◆ PERR# <ul style="list-style-type: none"> <li>– Enable or disable PCI device to generate PERR.</li> </ul> Options available: Enabled/Disabled. Default setting is <b>Disabled</b>. </li> <li>◆ SERR# <ul style="list-style-type: none"> <li>– Enable or disable PCI device to generate SERR.</li> </ul> Options available: Enabled/Disabled. Default setting is <b>Disabled</b>. </li> </ul>
Disable Above 4G Decoding	Options available: Enabled/Disabled. Default setting is <b>Disabled</b> .
Disable PCIe Init	Options available: Enabled/Disabled. Default setting is <b>Disabled</b> .
Disable PCIe GEN2	Options available: Enabled/Disabled. Default setting is <b>Disabled</b> .

## 5-2-5-1 PCI Express GEN 1 Settings

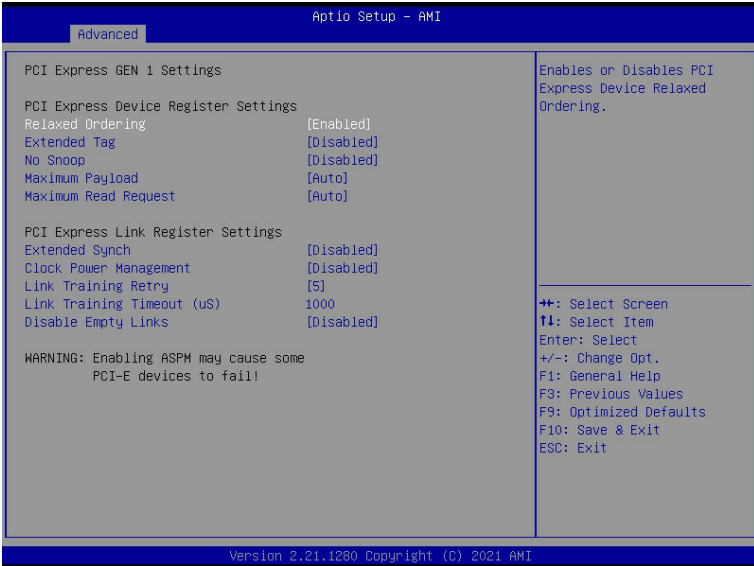

Parameter	Description
PCI Express GEN1 Setting	<p>PCI Express GEN1 Device Register Settings</p> <ul style="list-style-type: none"> <li>◆ Relaxed Ordering                             <ul style="list-style-type: none"> <li>– Enable or disable PCI Express Device Relaxed Ordering.</li> </ul>                             Options available: Enabled/Disabled. Default setting is <b>Enabled</b>.                         </li> <li>◆ Extend Tag                             <ul style="list-style-type: none"> <li>– If enabled, allows device to use 8-bit Tag field as a requester.</li> </ul>                             Options available: Enabled/Disabled. Default setting is <b>Disabled</b>.                         </li> <li>◆ No Snoop                             <ul style="list-style-type: none"> <li>– Enable or disable PCI Express Device No Snoop option.</li> </ul>                             Options available: Enabled/Disabled. Default setting is <b>Disabled</b>.                         </li> <li>◆ Maximum Payload                             <ul style="list-style-type: none"> <li>– Set Maximum Payload of PCI Express Device or allow System BIOS to select the value.</li> </ul>                             Options available: Auto/128 Bytes/ 256 Bytes. Default setting is <b>Auto</b>.                         </li> </ul>

Parameter	Description
PCI Express GEN1 Setting	PCI Express Device Link Register Settings ♦ Maximum Read Request – Set Maximum Read Request of PCI Express Device or allow System BIOS to select the value. Options available: Auto/128 /256/512/1024/2048/4096 Bytes. Default setting is <b>Auto</b> .
	♦ Extended Synch – If enabled, allows generation of Extended Synchronization patterns. Options available: Enabled/Disabled. Default setting is <b>Disabled</b> .
	♦ Clock Power Management – If support by hardware and set to 'Enabled', the device is permitted to use CLKREQ# signal for power management of link clock in accordance to protocol defined in appropriate form factor specification. Options available: Enabled/Disabled. Default setting is <b>Disabled</b> .
	♦ Link Training Retry – Defines numbers of Retry Attempts software will take to retrain the link if previous training attempt was unsuccessful. Options available: Disabled/2/3/5. Default setting is <b>Disabled</b> .
	♦ Link Training Timeout (uS) Press '+' and '-' keys to set the values. ♦ Link Training Retry – Defines numbers of Retry Attempts software will take to retrain the link if previous training attempt was unsuccessful. – ♦ Disable Empty Links – In order to save software will disable unpopulated PCI Express Device links, if this option set to 'Disabled Link'. Options available: Enabled/Disabled. Default setting is <b>Disabled</b> .

# 5-2-5-2 PCI Express GEN 2 Settings

Aptio Setup - AMI

Advanced

PCI Express GEN 2 Settings

PCI Express GEN2 Device Register Settings

Completion Timeout	[Default]
ARI Forwarding	[Disabled]
AtomicOp Requester Enable	[Disabled]
AtomicOp Egress Blocking	[Disabled]
ID0 Request Enable	[Disabled]
ID0 Completion Enable	[Disabled]
LTR Mechanism Enable	[Disabled]
End-End TLP Prefix Blocking	[Disabled]

PCI Express GEN2 Link Register Settings

Compliance SOS	[Disabled]
Hardware Autonomous Width	[Disabled]
Hardware Autonomous Speed	[Disabled]

In device Functions that support Completion Timeout programmability, allows system software to modify the Completion Timeout value. 'default' 50us to 50ms. If 'Shorter' is selected, software will use shorter timeout ranges supported by hardware. If 'Longer' is selected,

←+: Select Screen  
↑↓: Select Item  
Enter: Select  
+/-: Change Opt.  
F1: General Help  
F8: Previous Values  
F9: Optimized Defaults  
F10: Save & Exit  
ESC: Exit

Version 2.21.1280 Copyright (C) 2021 AMI

Parameter	Description
PCI Express GEN2 Setting	<p data-bbox="438 137 948 164">PCI Express GEN2 Device Register Settings</p> <ul style="list-style-type: none"> <li data-bbox="438 169 948 368">◆ Completion Timeout <ul style="list-style-type: none"> <li data-bbox="476 196 948 368">– In device Functions that support Completion Timeout programmability, allows system software to modify the Completion Timeout value. 'Default' 50us to 50ms. If 'Shorter' is selected, software will use shorter timeout ranges supported by hardware. If 'Longer' is selected, software will use longer timeout ranges.</li> </ul> </li> </ul> <p data-bbox="438 373 948 423">Options available: Default/Shorter/Longer/Disabled. Default setting is <b>Default</b>.</p> <ul style="list-style-type: none"> <li data-bbox="438 462 948 661">◆ ARI Forwarding <ul style="list-style-type: none"> <li data-bbox="476 489 948 661">– If supported by hardware and set to 'Enabled', the Downstream Port disables its traditional Device Number field being 0 enforcement when turning a Type1 Configuration Request into a Type0 Configuration Request, permitting access to Extended Functions in an ARI Device immediately below the Port.</li> </ul> </li> </ul> <p data-bbox="438 666 948 716">Options available: Default/Shorter/Longer/Disabled. Default setting is <b>Default</b>.</p> <ul style="list-style-type: none"> <li data-bbox="438 755 948 865">◆ AtomicOp Requester Enable <ul style="list-style-type: none"> <li data-bbox="476 782 948 865">– If supported by hardware and set to 'Enabled', this function initiates AtomicOp Requests only if Bus Master Enable bit is in the Command Register Set.</li> </ul> </li> </ul> <p data-bbox="438 870 948 890">Options available: Enabled/Disabled. Default setting is <b>Disabled</b>.</p> <ul style="list-style-type: none"> <li data-bbox="438 929 948 1008">◆ AtomicOp Egress Blocking <ul style="list-style-type: none"> <li data-bbox="476 956 948 1008">– If supported by hardware and set to 'Enabled', outbound AtomicOp Requests via Egress Ports will be blocked.</li> </ul> </li> </ul> <p data-bbox="438 1012 948 1033">Options available: Enabled/Disabled. Default setting is <b>Disabled</b>.</p> <ul style="list-style-type: none"> <li data-bbox="438 1072 948 1182">◆ IDO Request Enable <ul style="list-style-type: none"> <li data-bbox="476 1099 948 1182">– If supported by hardware and set to 'Enabled', this permits setting the number of ID-Based Ordering (IDO) bit (Attribute[2]) requests to be initiated..</li> </ul> </li> </ul> <p data-bbox="438 1186 948 1207">Options available: Enabled/Disabled. Default setting is <b>Disabled</b>.</p>

Parameter	Description
PCI Express GEN2 Setting	<p data-bbox="436 148 787 172">PCI Express GEN2 Device Register Settings</p> <ul style="list-style-type: none"> <li data-bbox="436 203 955 321">◆ IDO Request Enable <ul style="list-style-type: none"> <li data-bbox="468 235 955 321">– If supported by hardware and set to 'Enabled', this permits setting the number of ID-Based Ordering (IDO) bit (Attribute[2]) requests to be initiated.</li> </ul> </li> </ul> <p data-bbox="436 321 955 344">Options available: Enabled/Disabled. Default setting is <b>Disabled</b>.</p> <ul style="list-style-type: none"> <li data-bbox="436 352 955 470">◆ IDO Completion Enable <ul style="list-style-type: none"> <li data-bbox="468 384 955 470">– If supported by hardware and set to 'Enabled', this permits setting the number of ID-Based Ordering (IDO) bit (Attribute[2]) requests to be initiated.</li> </ul> </li> </ul> <p data-bbox="436 470 955 493">Options available: Enabled/Disabled. Default setting is <b>Disabled</b>.</p> <ul style="list-style-type: none"> <li data-bbox="436 501 955 619">◆ LTR Mechanism Enable <ul style="list-style-type: none"> <li data-bbox="468 533 955 619">– If supported by hardware and set to 'Enabled', this enables the Latency Tolerance Reporting (LTR) Mechanism.</li> </ul> </li> </ul> <p data-bbox="436 619 955 642">Options available: Enabled/Disabled. Default setting is <b>Disabled</b>.</p> <ul style="list-style-type: none"> <li data-bbox="436 650 955 768">◆ End-End TLP Prefix Blocking <ul style="list-style-type: none"> <li data-bbox="468 682 955 768">– If supported by hardware and set to 'Enabled', this function will block forwarding of TLPs containing End-End TLP Prefixes.</li> </ul> </li> </ul> <p data-bbox="436 768 955 791">Options available: Enabled/Disabled. Default setting is <b>Disabled</b>.</p>
	<p data-bbox="436 823 755 846">PCI Express GEN2 Device Link Settings</p> <ul style="list-style-type: none"> <li data-bbox="436 878 955 1027">◆ Compliance SOS <ul style="list-style-type: none"> <li data-bbox="468 909 955 1027">– If supported by hardware and set to 'Enabled', this will force LTSSM to send SKP Ordered Sets between sequences when sending Compliance Pattern or Modified Compliance Pattern.</li> </ul> </li> </ul> <p data-bbox="436 1027 955 1050">Options available: Enabled/Disabled. Default setting is <b>Disabled</b>.</p> <ul style="list-style-type: none"> <li data-bbox="436 1058 955 1199">◆ Hardware Autonomous Width <ul style="list-style-type: none"> <li data-bbox="468 1089 955 1199">– If supported by hardware and set to 'Disabled', this will disable the hardware's ability to change link width except width size reduction for the purpose of correcting unstable link operation.</li> </ul> </li> </ul> <p data-bbox="436 1199 955 1223">Options available: Enabled/Disabled. Default setting is <b>Disabled</b>.</p> <ul style="list-style-type: none"> <li data-bbox="436 1230 955 1372">◆ Hardware Autonomous Speed <ul style="list-style-type: none"> <li data-bbox="468 1262 955 1372">– If supported by hardware and set to 'Disabled', this will disable the hardware's ability to change link speed except speed rate reduction for the purpose of correcting unstable link operation</li> </ul> </li> </ul> <p data-bbox="436 1372 955 1395">Options available: Enabled/Disabled. Default setting is <b>Disabled</b>.</p>



## 5-2-6 Info Report Configuration

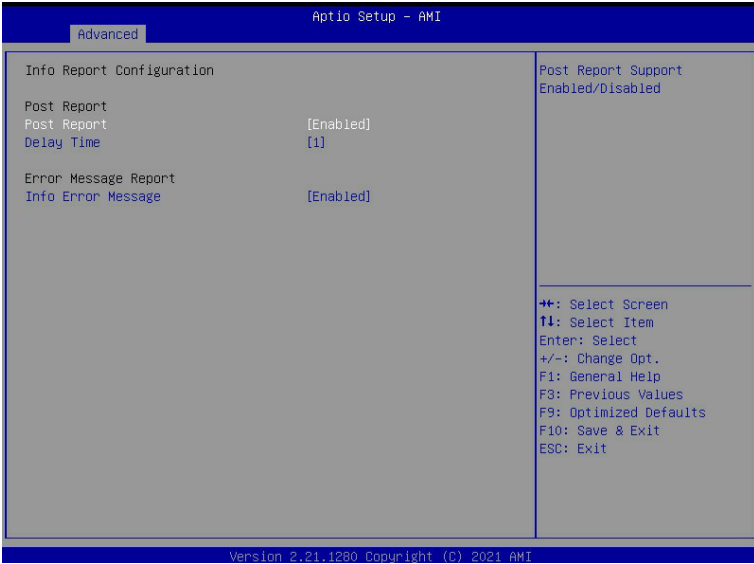

Parameter	Description
Info Report Configuration	
Post Report	
Post Report	Enable/Disable Post Report support. Options available: Enabled/Disabled. Default setting is Enabled.
Delay Time	Options available: 0/1/2/3/4/5/6/7/8/9/10/Util Press ESC. Default setting is 1.
Error Message Report	
Info Error Message	Enable/Disable Info Error Message support. Options available: Enabled/Disabled. Default setting is <b>Enabled</b> .

## 5-2-7 USB Configuration

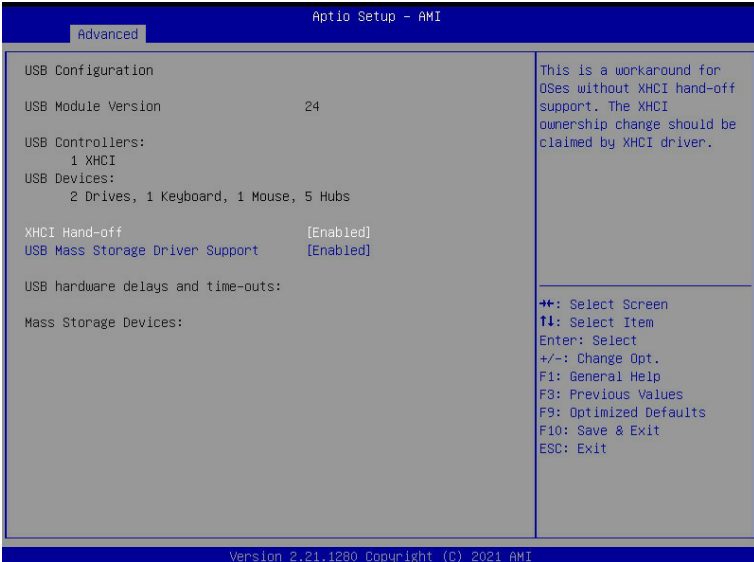

Parameter	Description
USB Configuration	
USB Module Version	Displays USB module version information.
USB Controller	Displays the supported USB controllers.
USB Devices:	Displays the USB devices connected to the system.
XHCI Hand-off	Enable/Disable the XHCI (USB 3.0) Hand-off support. Options available: Enabled/Disabled. Default setting is <b>Enabled</b> .
USB Mass Storage Driver Support <sup>(Note)</sup>	Enable/Disable the USB Mass Storage Driver Support. Options available: Enabled/Disabled. Default setting is <b>Enabled</b> .

(Note) This item is present only if you attach USB devices.

## 5-2-8 Network Stack

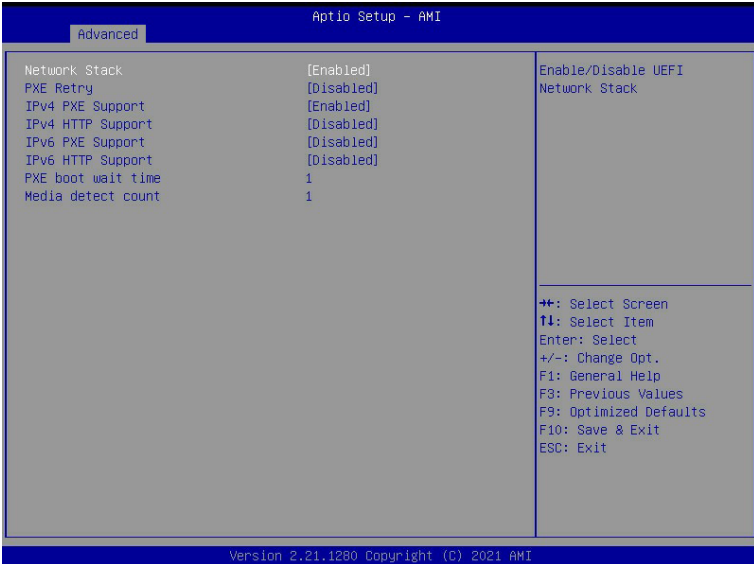

Parameter	Description
Network Stack	Enable/Disable the UEFI network stack. Options available: Enabled/Disabled. Default setting is <b>Enabled</b> .
Ipv4 PXE Support	Enable/Disable the Ipv4 PXE feature. Options available: Enabled/Disabled. Default setting is <b>Enabled</b> .
Ipv4 HTTP Support	Enable/Disable the Ipv4 HTTP feature. Options available: Enabled/Disabled. Default setting is <b>Disabled</b> .
Ipv6 PXE Support	Enable/Disable the Ipv6 PXE feature. Options available: Enabled/Disabled. Default setting is <b>Disabled</b> .
Ipv6 HTTP Support	Enable/Disable the Ipv6 HTTP feature. Options available: Enabled/Disabled. Default setting is <b>Disabled</b> .
IPSEC Certificate	Enable/Disable the IPSEC Certificate feature.
Media detect count	Press the <+> / <-> keys to increase or decrease the desired values.

## 5-2-9 NVMe Configuration

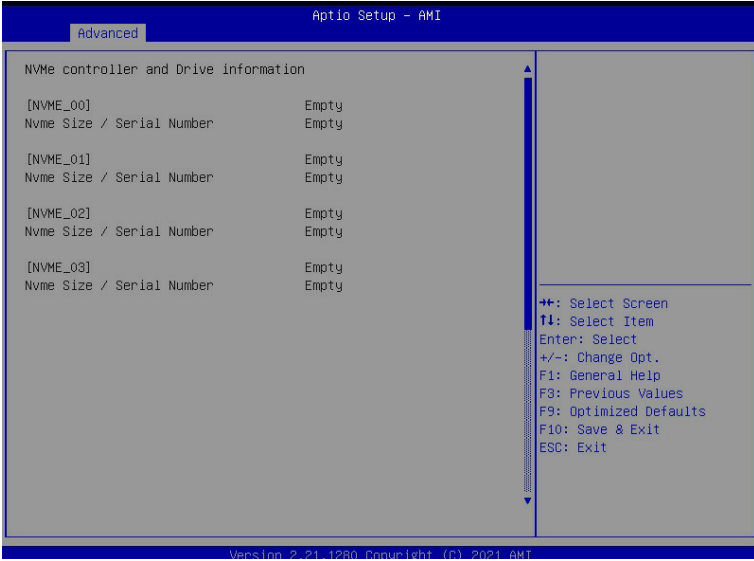

Parameter	Description
NVMe controller and Drive Information	Displays the NVMe devices connected to the system.

## 5-2-10 Power Restore Configuration

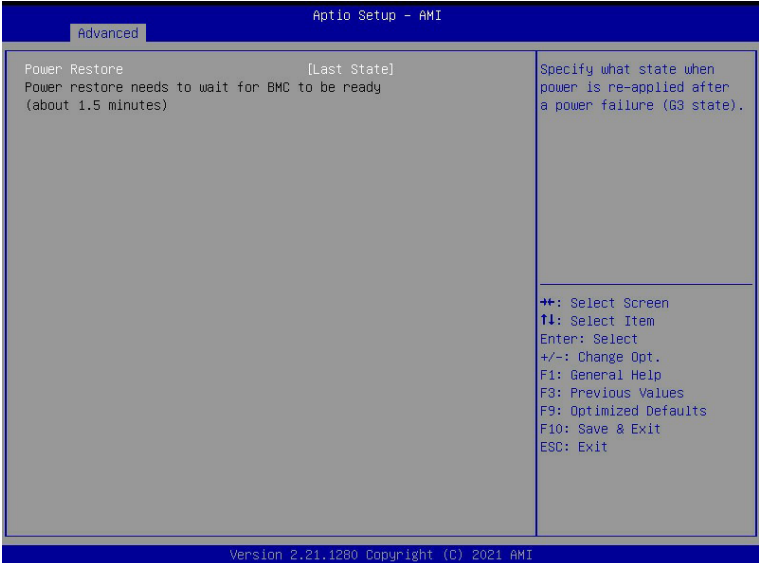

Parameter	Description
Power Restore	Specify what state when power is re-applied after a power failure (G3 state). Options available: Last State/Power On/Power Off. Default setting is <b>Last State</b> .

## 5-2-11 Intel(R) I350 Gigabit Network Connection

Aptio Setup - AMI																					
Advanced																					
▶ NIC Configuration <table border="0" style="width: 100%;"> <tr> <td style="width: 30%;">Blink LEDs</td> <td style="text-align: right;">0</td> </tr> <tr> <td>UEFI Driver</td> <td>Intel(R) PRO/1000 Open Source 9.2.06 PCI-E</td> </tr> <tr> <td>Adapter PBA</td> <td>106300-000</td> </tr> <tr> <td>Device Name</td> <td>Intel(R) I350 Gigabit Network Connection</td> </tr> <tr> <td>Chip Type</td> <td>Intel i350</td> </tr> <tr> <td>PCI Device ID</td> <td>1521</td> </tr> <tr> <td>PCI Address</td> <td>02:00:00</td> </tr> <tr> <td>Link Status</td> <td>[Disconnected]</td> </tr> <tr> <td>MAC Address</td> <td>18:C0:4D:0F:F6:CC</td> </tr> <tr> <td>Virtual MAC Address</td> <td>00:00:00:00:00:00</td> </tr> </table>		Blink LEDs	0	UEFI Driver	Intel(R) PRO/1000 Open Source 9.2.06 PCI-E	Adapter PBA	106300-000	Device Name	Intel(R) I350 Gigabit Network Connection	Chip Type	Intel i350	PCI Device ID	1521	PCI Address	02:00:00	Link Status	[Disconnected]	MAC Address	18:C0:4D:0F:F6:CC	Virtual MAC Address	00:00:00:00:00:00
Blink LEDs	0																				
UEFI Driver	Intel(R) PRO/1000 Open Source 9.2.06 PCI-E																				
Adapter PBA	106300-000																				
Device Name	Intel(R) I350 Gigabit Network Connection																				
Chip Type	Intel i350																				
PCI Device ID	1521																				
PCI Address	02:00:00																				
Link Status	[Disconnected]																				
MAC Address	18:C0:4D:0F:F6:CC																				
Virtual MAC Address	00:00:00:00:00:00																				
Click to configure the network device port.																					
++: Select Screen ↑↓: Select Item Enter: Select +/-: Change Opt. F1: General Help F8: Previous Values F9: Optimized Defaults F10: Save & Exit ESC: Exit																					
Version 2.21.1280 Copyright (C) 2021 AMI																					

Aptio Setup - AMI					
Advanced					
<table border="0" style="width: 100%;"> <tr> <td style="width: 30%;">Link Speed</td> <td style="text-align: right;">[Auto Negotiated]</td> </tr> <tr> <td>Wake On LAN</td> <td style="text-align: right;">[Enabled]</td> </tr> </table>		Link Speed	[Auto Negotiated]	Wake On LAN	[Enabled]
Link Speed	[Auto Negotiated]				
Wake On LAN	[Enabled]				
Specifies the port speed used for the selected boot protocol.					
++: Select Screen ↑↓: Select Item Enter: Select +/-: Change Opt. F1: General Help F8: Previous Values F9: Optimized Defaults F10: Save & Exit ESC: Exit					
Version 2.21.1280 Copyright (C) 2021 AMI					

Parameter	Description
NIC Configuration	<p>Press [Enter] to configure advanced items.</p> <ul style="list-style-type: none"> <li>◆ Link Speed <ul style="list-style-type: none"> <li>– Allows for automatic link speed adjustment.</li> <li>– Options available: Auto Negotiated/10 Mbps Half/10 Mbps Full/100 Mbps Half/100 Mbps Full. Default setting is <b>Auto Negotiated</b>.</li> </ul> </li> <li>◆ Wake On LAN <ul style="list-style-type: none"> <li>– Enables power on of the system via LAN. Note that configuring Wake on LAN in the operating system does not change the value of this setting, but does override the behavior of Wake on LAN in OS controlled power states.</li> <li>– Options available: Enabled/Disabled. Default setting is <b>Enabled</b>.</li> </ul> </li> </ul>
Blink LEDs	<p>Identifies the physical network port by blinking the associated LED. Press the numeric keys to adjust desired values.</p>
UEFI Driver	Displays the technical specifications for the Network Interface Controller.
Adapter PBA	Displays the technical specifications for the Network Interface Controller.
Device Name	Displays the technical specifications for the Network Interface Controller.
Chip Type	Displays the technical specifications for the Network Interface Controller.
PCI Device ID	Displays the technical specifications for the Network Interface Controller.
PCI Address	Displays the technical specifications for the Network Interface Controller.
Link Status	Displays the technical specifications for the Network Interface Controller.
MAC Address	Displays the technical specifications for the Network Interface Controller.
Virtual MAC Address	Displays the technical specifications for the Network Interface Controller.

## 5-2-12 MAC IPv4 Network Configuration

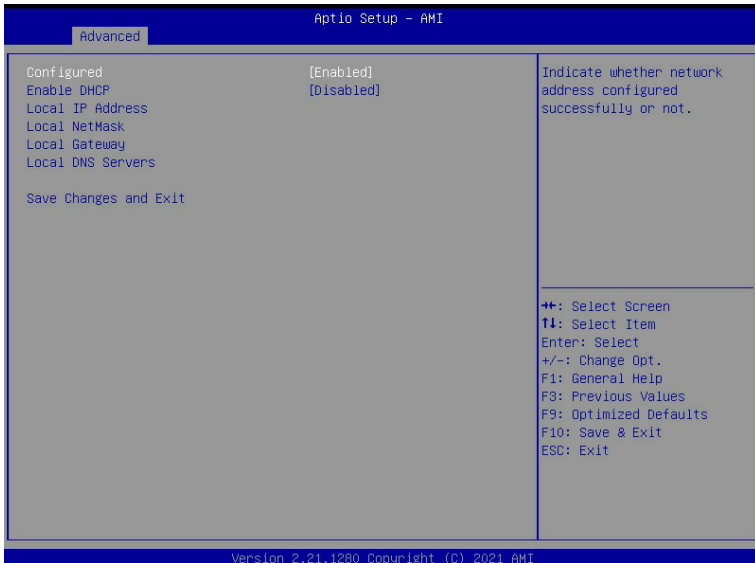

Parameter	Description
Configured <sup>(Note)</sup>	Options available: Enabled/Disabled. Default setting is <b>Disabled</b> .
Enable DHCP	Options available: Enabled/Disabled. Default setting is <b>Enabled</b> .
Local IP Address	Press [Enter] to configure local IP address.
Local NetMask	Press [Enter] to configure local NetMask.
Local Gateway	Press [Enter] to configure local Gateway
Local DNS Servers	Press [Enter] to configure local DNS servers
Save Changes and Exit	Press [Enter] save all configurations.

(Note) Advance items prompt when this item set to **Enabled**.



## 5-2-13 MAC IPv6 Network Configuration

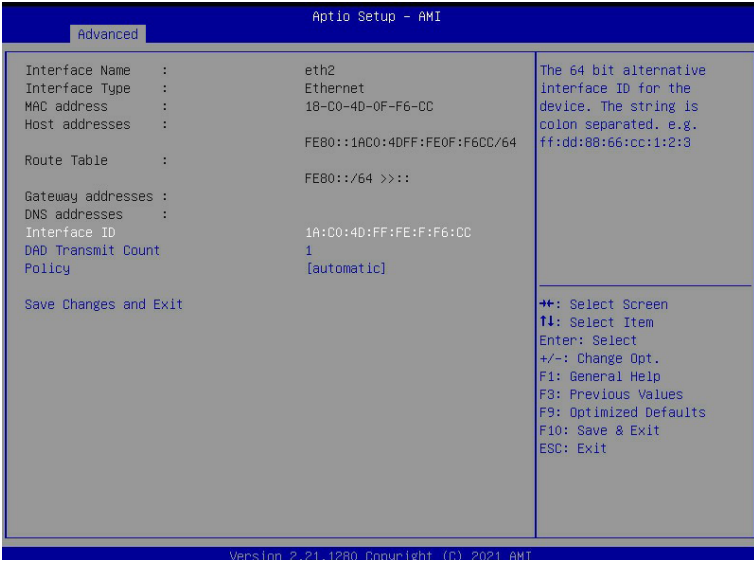

Parameter	Description
Enter Configuration Menu	Press [Enter] for configuration of advanced items.

### 5-3 Chipset Setup Menu

Chipset Setup menu displays submenu options for configuring the function of the North Bridge. Select a submenu item, then press [Enter] to access the related submenu screen.

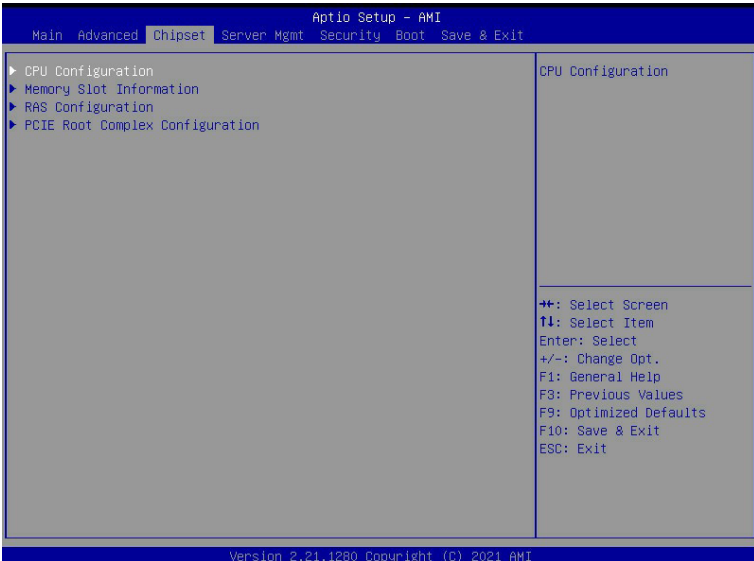

Parameter	Description
CPU Configuration	Press [Enter] for configuration of advanced items.
Memory Slot Configuration	Press [Enter] for configuration of advanced items.
RAS Configuration	Press [Enter] for configuration of advanced items.
PCIE Root Complex Configuration	Press [Enter] for configuration of advanced items.

### 5-3-1 CPU Configuration

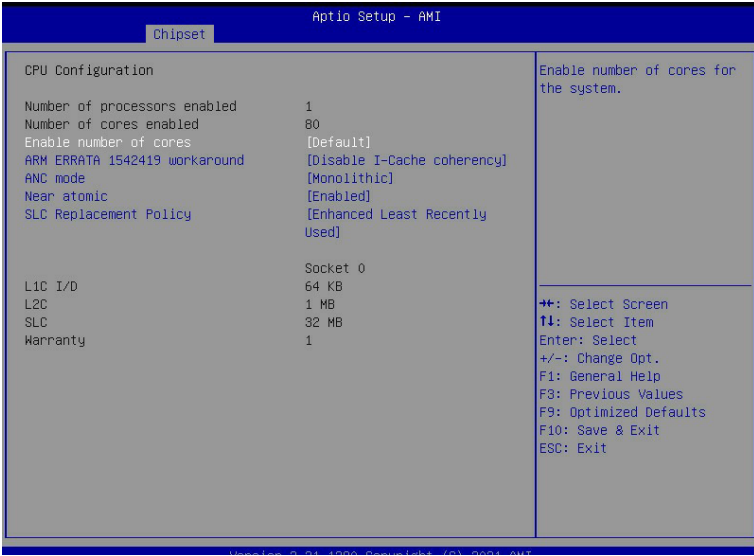

Parameter	Description
CPU Configuration	
Numbers of processor enabled	Displays the number of installed processor information.
Enable number of cores	Option: Default/2/4/6/8/10/12/14/16/18/20/22/24/26/28/30/32/34/36....80. Default Setting is <b>Default</b> .
ARM ERRATA 1542419 workaround	Option available: Disable I-Cache coherency/Software solution/Disable. Default Setting is <b>Disable I-Cache coherency</b> .
ANC mode	Option available: Monolithic/Hemisphere/Quadrant. Default Setting is <b>Monolithic</b> .
Near atomic	Enable/disable cacheable atomic instruction executed near in CPU. Option available: Enabled/Disabled. Default Setting is <b>Enabled</b> .
SLC Replacement Policy	Option available: Enhanced Least Recently Used/Linear-Feedback Shift Register. Default Setting is <b>Enhanced Least Recently Used</b> .
L1C I/D L2C SLC Warranty	Displays the technical specifications for the installed processor.

### 5-3-2 Memory Slot Information

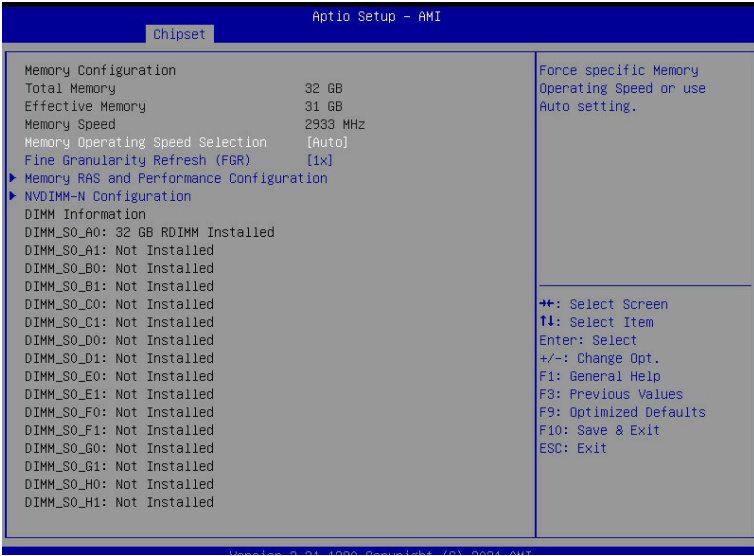

Parameter	Description
Memory Configuration	
Total Memory	
Effective Memory	Displays the technical specifications for the installed DIMM.
Memory Speed	
Memory Operating Speed Selection	Option available: Auto/2133/2400/2666/2933/3200. Default setting: <b>Auto</b> .
Fine Granularity Refresh (FGR)	Select DDR Fine Granularity Refresh (FGR) mode. Option available: 1x/2x/4x. Default setting is <b>1x</b> .
Memory RAS and Performance Configuration	Press [Enter] for advanced configuration.
NVDIMM -N Configuration	Press [Enter] for advanced configuration.
DIMM Information	Display installed DIMM information.

### 5-3-2-1 Memory RAS and Performance Configuration

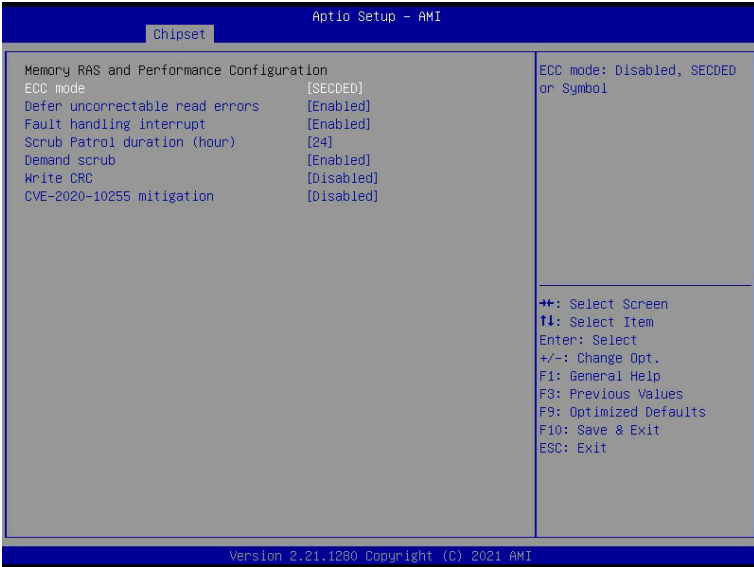

Parameter	Description
Memory RAS and Performance Configuration	
ECC Mode	Option available: Disabled/SECCDED/Symbol Default setting: SECCDED.
Defer uncorrectable read errors	Option available: Enabled/Disabled. Default setting: <b>Disabled</b> .
Fault handling interrupt	Option available: Enabled/Disabled. Default setting: <b>Enabled</b> .
Scrub Patrol duration (hour)	Option available: 1...24. Default setting: <b>24</b> .
Demand scrub	Option available: Enabled/Disabled. Default setting: <b>Enabled</b> .
Write CRC	Option available: Enabled/Disabled. Default setting: <b>Disabled</b> .
CVE=2020-10255 mitigation	Option available: Enabled/Disabled. Default setting: <b>Disabled</b> .

### 5-3-2-2 NVDIMM-N Configuration

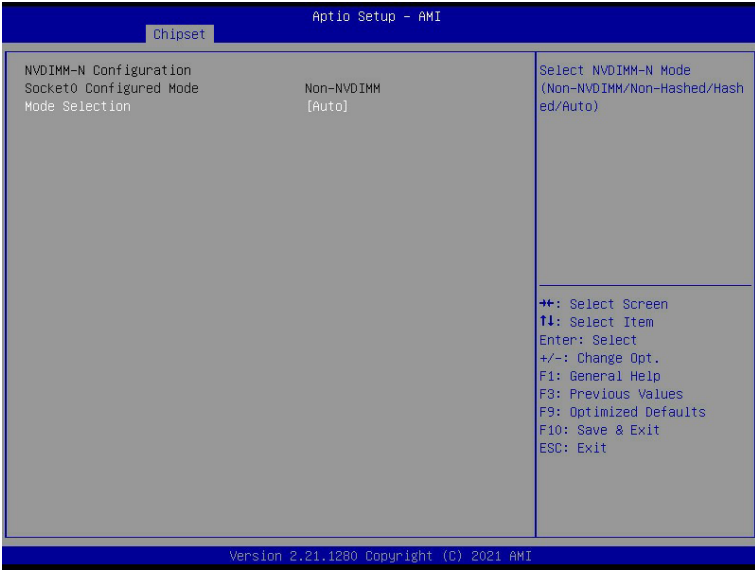

Parameter	Description
NVDIMM-N Configuration	
Socket0 Configuration	
Mode Selection	Select NVDIMM-N Mode. Option available: Non-NVDIMM/Non-Hashed/Hashed/Auto. Default setting: <b>Auto</b> .

### 5-3-3 RAS Configuration

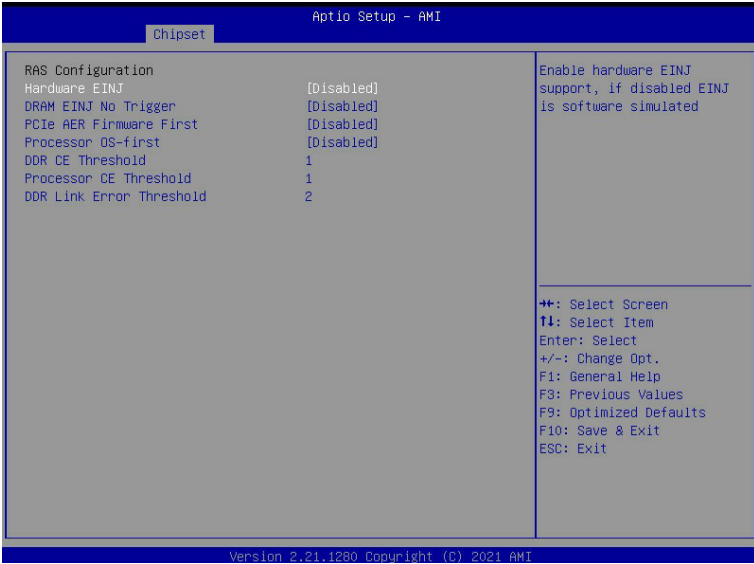

Parameter	Description
RAS Configuration	
Hardware EIJN	Option available: Enabled/Disabled. Default setting: <b>Disabled</b> .
PCIe AER Firmware First	Option available: Enabled/Disabled. Default setting: <b>Disabled</b> .
DDR CE Threshold	Press '+' or '-' to configure the threshold.
Processor CE Threshold	Press '+' or '-' to configure the threshold.
DDR Kink Error Threshold	Press '+' or '-' to configure the threshold.

### 5-3-4 PCIe Root Complex Configuration

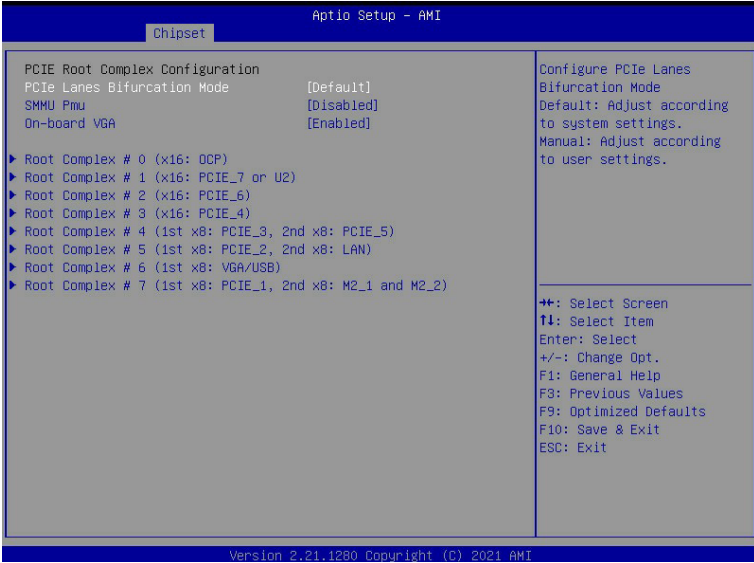

Parameter	Description
PCIe Root Complex Configuration	
PCIe Lanes Bifurcation	Option available: Manual/Default. Default setting: <b>Default</b> .
SMMU Pmu	Enable/Disable PMU feature for SMMU. Option available: Enabled/Disabled. Default setting: <b>Disabled</b> .
On-board VGA	Enable/Disable on-board VGA. Option available: Enabled/Disabled. Default setting: <b>Enabled</b> .
Root Complex_# <sup>(Note)</sup>	Press [Enter] to view advanced items.

(Note) Advance items can be configurable when PCIe Lanes Bifurcation is set to **Manual**.



## 5-4 Server Management Menu

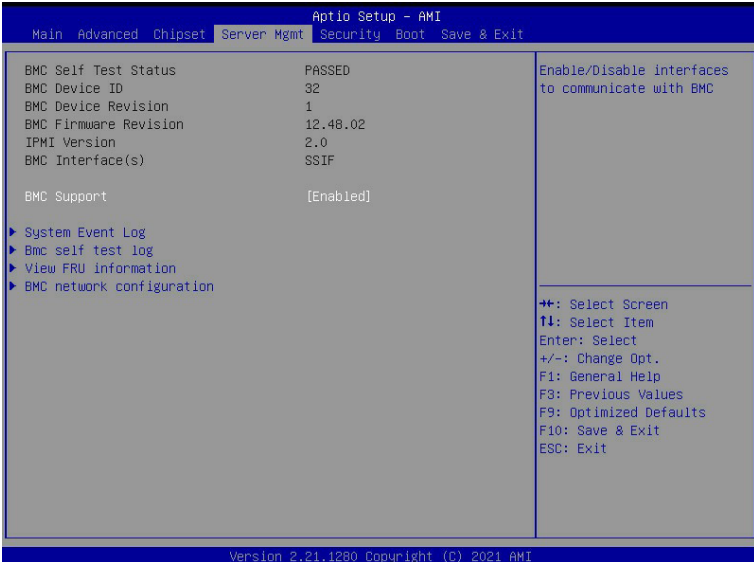

Parameter	Description
BMC Support	Enable/Disable interfaces to communicate with BMC. Options available: Enabled/Disabled. Default setting is <b>Enabled</b> .
System Event Log	Press [Enter] to configure advanced items.
BMC self test	Press [Enter] to configure advanced items.
View FRU Information	Press [Enter] to view the advanced items.
BMC network configuration	Press [Enter] to configure advanced items.

## 5-4-1 System Event Log

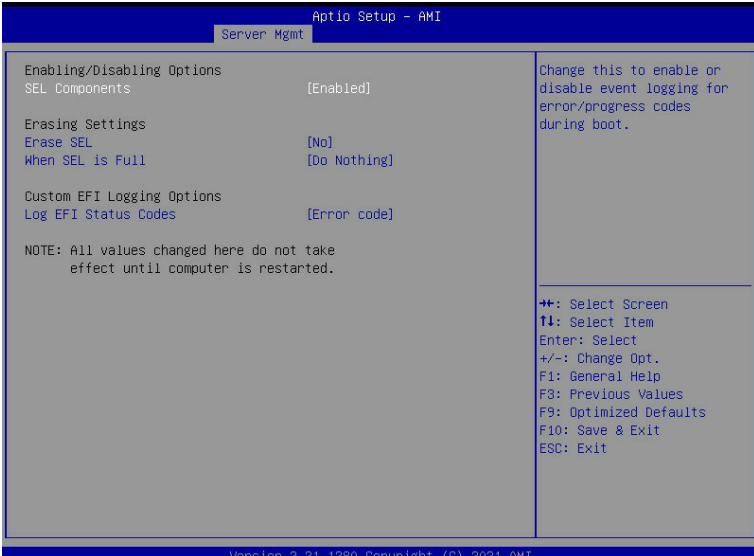

Parameter	Description
Enabling / Disabling Options	
SEL Components	Change this item to enable or disable all features of System Event Logging during boot. Options available: Enabled/Disabled. Default setting is <b>Enabled</b> .
Erasing Settings	
Erasing SEL	Choose options for erasing SEL. Options available: No/Yes, On next reset/Yes, On every reset. Default setting is <b>No</b> .
When SEL is Full	Choose options for reactions to a full SEL. Options available: Do Nothing/Erase Immediately/Delete Oldest Record. Default setting is <b>Do Nothing</b> .
Custom EFI Logging Options	
Log EFI Status Codes	Enable/Disable the logging of EFI Status Codes (if not already converted to legacy). Options available: Disabled/Both/Error code/Progress code. Default setting is <b>Error code</b> .

## 5-4-2 BMC self test

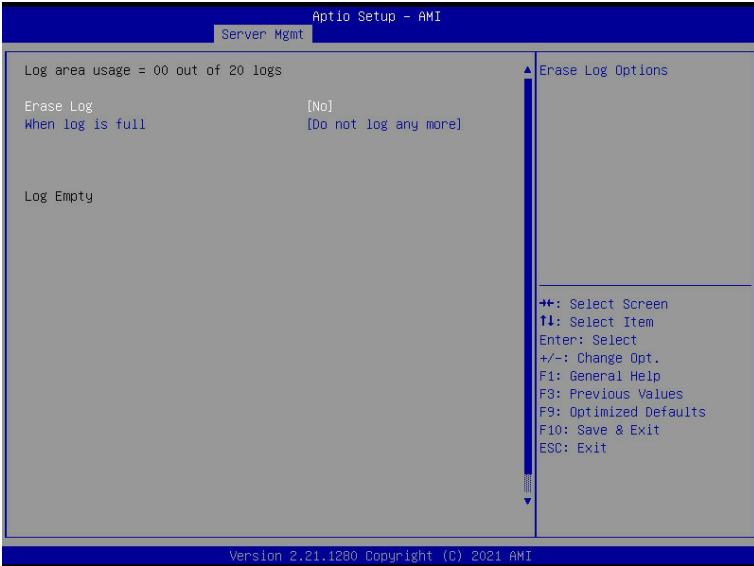

Parameter	Description
log area usage =00 out of 20 logs	
Erase Log	Options available: No/Yes, On next reset/Yes, On every reset. Default setting is <b>No</b> .
When Log is full	Configuration for reactions to a full log. Option available: Do not log any more/Clear Log. Default setting is <b>Do not log any more</b> .

### 5-4-3 View FRU Information

The FRU page is a simple display page for basic system ID information, as well as System product information. Items on this window are non-configurable.

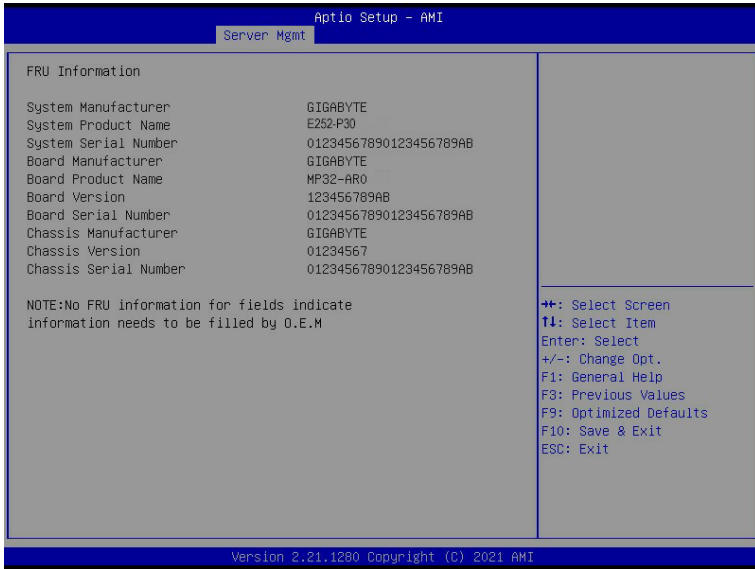

(Note) The model name will vary depends on the product you purchased.

## 5-4-4 BMC Network Configuration

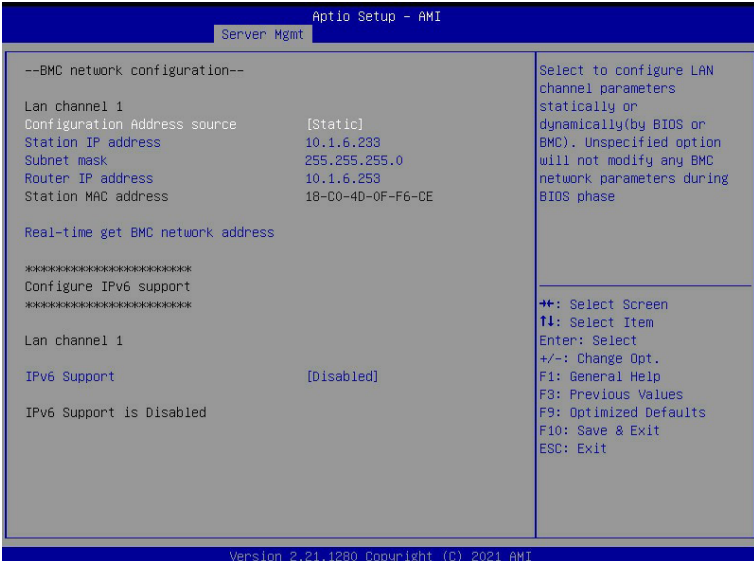

Parameter	Description
BMC network configuration	
Lan Channel 1	
Configuration Address source	Select to configure LAN channel parameters statically or dynamically (DHCP). Do nothing option will not modify any BMC network parameters during BIOS phase. Options available: Unspecified/Static/DynamicBmcDhcp. Default setting is <b>DynamicBmcDhcp</b> .
Station IP address	Displays IP Address information.
Subnet mask	Displays Subnet Mask information. Please note that the IP address must be in three digitals, for example, 192.168.000.001.
Router IP address	Displays the Router IP Address information.
Station MAC address	Displays the MAC Address information.
Real-time get BMC network address	Press [Enter] to synchronize the BMC network address
IPv6 Support <sup>(Note)</sup>	Option available: Enabled/Disabled. Default Setting is <b>Disabled</b> .

(Note) Advance items can be configurable when IPv6 Support is set to **Enabled**.

# 5-5 Security Menu

The Security menu allows you to safeguard and protect the system from unauthorized use by setting up access passwords.

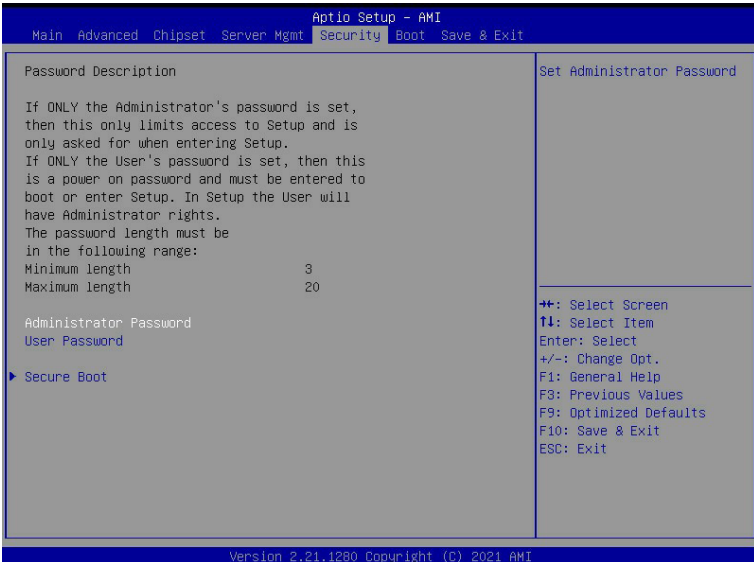

There are two types of passwords that you can set:

- Administrator Password  
Entering this password will allow the user to access and change all settings in the Setup Utility.
- User Password  
Entering this password will restrict a user's access to the Setup menus. To enable or disable this field, a Administrator Password must first be set. A user can only access and modify the System Time, System Date, and Set User Password fields.

Parameter	Description
Administrator Password	Press [Enter] to configure the administrator password.
User Password	Press [Enter] to configure the user password.
Secure Boot	Press [Enter] to configure advanced items.

## 5-5-1 Secure Boot



Parameter	Description
System Mode	Displays the system is in User mode or Setup mode.
Secure Boot Mode <sup>(Note)</sup>	<p>Secure Boot requires all the applications that are running during the booting process to be pre-signed with valid digital certificates. This way, the system knows all the files being loaded before Windows loads and gets to the login screen have not been tampered with.</p> <p>When set to Standard, it will automatically load the Secure Boot keys from the BIOS databases.</p> <p>When set to Custom, you can customize the Secure Boot settings and manually load its keys from the BIOS database.</p> <p>Options available: Standard/Custom. Default setting is Custom.</p>

(Note) Advanced items prompt when this item is set to **Custom**.

Parameter	Description
Key Management	<p data-bbox="333 137 668 161">Press [Enter] to configure advanced items.</p> <p data-bbox="333 164 939 216"><b>Please note that this item is configurable when Secure Boot Mode is set to Custom.</b></p> <ul style="list-style-type: none"> <li data-bbox="333 224 952 330">◆ Provision Factory Defaults <ul style="list-style-type: none"> <li data-bbox="370 252 952 304">– Allows to provision factory default Secure Boot keys when system is in Setup Mode.</li> <li data-bbox="370 307 902 330">– Options available: Enabled/Disabled. Default setting is <b>Disabled</b>.</li> </ul> </li> <li data-bbox="333 333 952 413">◆ Install Factory Default Keys <ul style="list-style-type: none"> <li data-bbox="370 362 926 385">– Installs all factory default keys. It will force the system in User Mode.</li> <li data-bbox="370 388 602 413">– Options available: Yes/No.</li> </ul> </li> <li data-bbox="333 417 952 497">◆ Enroll Efi Image <ul style="list-style-type: none"> <li data-bbox="370 445 902 497">– Press [Enter] to enroll SHA256 hash of the binary into Authorized Signature Database (db).</li> </ul> </li> <li data-bbox="333 500 952 551">◆ Save all Secure Boot variables <ul style="list-style-type: none"> <li data-bbox="370 528 876 551">– Press [Enter] to save all Secure Boot Keys and Key variables.</li> </ul> </li> <li data-bbox="333 555 952 606">◆ Secure Boot variable <ul style="list-style-type: none"> <li data-bbox="370 588 898 611">– Displays the current status of the variables used for secure boot.</li> </ul> </li> <li data-bbox="333 609 952 721">◆ Platform Key (PK) <ul style="list-style-type: none"> <li data-bbox="370 638 802 661">– Displays the current status of the Platform Key (PK).</li> <li data-bbox="370 664 678 688">– Press [Enter] to configure a new PK.</li> <li data-bbox="370 691 610 715">– Options available: Set New.</li> </ul> </li> <li data-bbox="333 724 952 860">◆ Key Exchange Keys (KEK) <ul style="list-style-type: none"> <li data-bbox="370 752 944 776">– Displays the current status of the Key Exchange Key Database (KEK).</li> <li data-bbox="370 779 905 829">– Press [Enter] to configure a new KEK or load additional KEK from storage devices.</li> <li data-bbox="370 832 676 856">– Options available: Set New/Append.</li> </ul> </li> <li data-bbox="333 863 952 1000">◆ Authorized Signatures (DB) <ul style="list-style-type: none"> <li data-bbox="370 892 905 915">– Displays the current status of the Authorized Signature Database.</li> <li data-bbox="370 918 948 969">– Press [Enter] to configure a new DB or load additional DB from storage devices.</li> <li data-bbox="370 972 676 995">– Options available: Set New/Append.</li> </ul> </li> <li data-bbox="333 1003 952 1139">◆ Forbidden Signatures (DBX) <ul style="list-style-type: none"> <li data-bbox="370 1031 902 1055">– Displays the current status of the Forbidden Signature Database.</li> <li data-bbox="370 1058 892 1108">– Press [Enter] to configure a new dbx or load additional dbx from storage devices.</li> <li data-bbox="370 1111 676 1135">– Options available: Set New/Append.</li> </ul> </li> <li data-bbox="333 1143 952 1279">◆ Authorized TimeStamps (DBT) <ul style="list-style-type: none"> <li data-bbox="370 1171 929 1194">– Displays the current status of the Authorized TimeStamps Database.</li> <li data-bbox="370 1197 905 1248">– Press [Enter] to configure a new DBT or load additional DBT from storage devices.</li> <li data-bbox="370 1251 676 1274">– Options available: Set New/Append.</li> </ul> </li> <li data-bbox="333 1282 952 1419">◆ OsRecovery Signatures <ul style="list-style-type: none"> <li data-bbox="370 1310 919 1334">– Displays the current status of the OsRecovery Signature Database.</li> <li data-bbox="370 1337 887 1387">– Press [Enter] to configure a new OsRecovery Signature or load additional OsRecovery Signature from storage devices.</li> <li data-bbox="370 1390 676 1414">– Options available: Set New/Append.</li> </ul> </li> </ul>



## 5-6 Boot Menu

The Boot menu allows you to set the drive priority during system boot-up. BIOS setup will display an error message if the legacy drive(s) specified is not bootable.

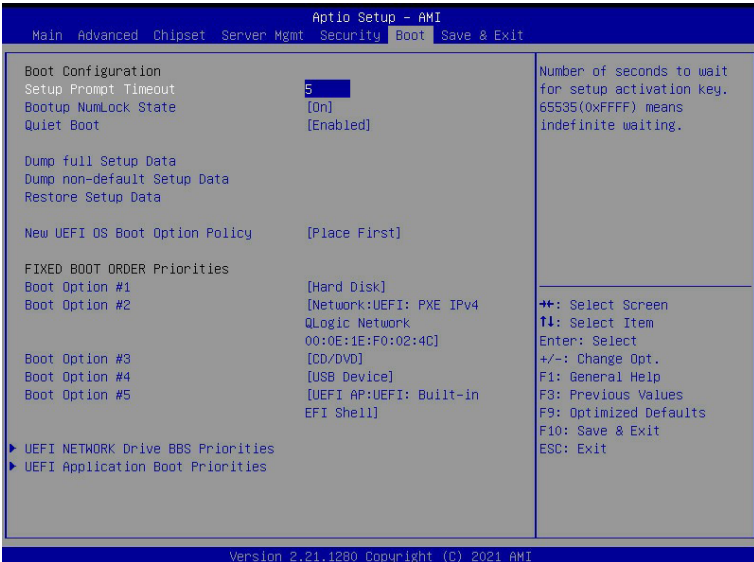

Parameter	Description
Boot Configuration	
Setup Prompt Timeout	Number of seconds to wait for setup activation key. 65535 (0xFFFF) means indefinite waiting. Press the numeric keys to input the desired values.
Bootup NumLock State	Enable/Disable the Bootup NumLock function. Options available: On/Off. Default setting is <b>On</b> .
Quiet Boot	Enable/Disable showing the logo during POST. Options available: Enabled/Disabled. Default setting is <b>Enabled</b> .
Boot mode select	Selects the boot mode. Options available: LEGACY/UEFI. Default setting is <b>UEFI</b> .

Parameter	Description
Dump full Setup Data	
Dump non-default Setup Data	
Restore Setup Date	
New UEFI OS Boot Option Policy	Option available: Default/Place First/Place Last. Default setting is <b>Place First</b> .
FIXED BOOT ORDER	
Priorities	
Boot Option #1 / #2 / #3 / #4 / #5	Press [Enter] to configure the boot priority. By default, the server searches for boot devices in the following sequence: <ol style="list-style-type: none"> <li>1. Hard drive.</li> <li>2. CD-COM/DVD drive.</li> <li>3. USB device.</li> <li>4. Network.</li> <li>5. UEFI.</li> </ol>
UEFI Network Drive BBS Priorities	Press [Enter] to configure the boot priority.
UEFI Application Boot Priorities	Press [Enter] to configure the boot priority.

## 5-7 Save & Exit Menu

The Exit menu displays the various options to quit from the BIOS setup. Highlight any of the exit options then press **Enter**.

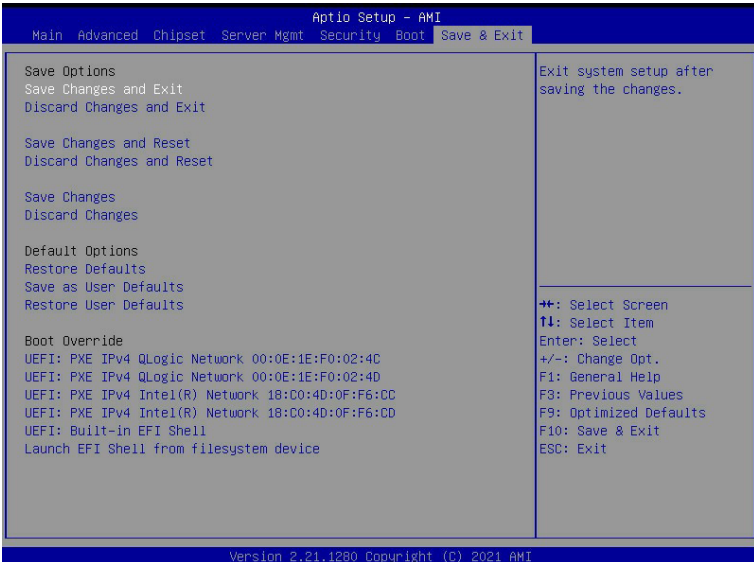

Parameter	Description
Save Options	
Save Changes and Exit	Saves changes made and closes the BIOS setup. Options available: Yes/No.
Discard Changes and Exit	Discards changes made and exits the BIOS setup. Options available: Yes/No.
Save Changes	Save changes done so far to any of the setup options. Options available: Yes/No.
Default Options	
Restore Defaults	Loads the default settings for all BIOS setup parameters. Setup Defaults are quite demanding in terms of resources consumption. If you are using low-speed memory chips or other kinds of low-performance components and you choose to load these settings, the system might not function properly. Options available: Yes/No.
Boot Override	Press [Enter] to configure the device as the boot-up drive.

## 5-8 BIOS POST Beep code (AMI standard)

### 5-8-1 PEI Beep Codes

# of Beeps	Description
1	Memory not Installed.
1	Memory was installed twice (InstallPeiMemory routine in PEI Core called twice)
2	Recovery started
3	DXE IPL was not found
3	DXE Core Firmware Volume was not found
4	Recovery failed
4	S3 Resume failed
7	Reset PPI is not available

### 5-8-2 DXE Beep Codes

# of Beeps	Description
1	Invalid password
4	Some of the Architectural Protocols are not available
5	No Console Output Devices are found
5	No Console Input Devices are found
6	Flash update is failed
7	Reset protocol is not available
8	Platform PCI resource requirements cannot be met