

GIGABYTE™

R282-P91

Ampere® Altra® Max ARM Server - 2U DP 24+4-Bay

User Manual

Rev. 1.0

Copyright

© 2022 GIGA-BYTE TECHNOLOGY CO., LTD. All rights reserved.

The trademarks mentioned in this manual are legally registered to their respective owners.

Disclaimer

Information in this manual is protected by copyright laws and is the property of GIGABYTE. Changes to the specifications and features in this manual may be made by GIGABYTE without prior notice. No part of this manual may be reproduced, copied, translated, transmitted, or published in any form or by any means without GIGABYTE's prior written permission.

Documentation Classifications

In order to assist in the use of this product, GIGABYTE provides the following types of documentation:

- User Manual: detailed information & steps about the installation, configuration and use of this product (e.g. motherboard, server barebones), covering hardware and BIOS.
- User Guide: detailed information about the installation & use of an add-on hardware or software component (e.g. BMC firmware, rail-kit) compatible with this product.
- Quick Installation Guide: a short guide with visual diagrams that you can reference easily for installation purposes of this product (e.g. motherboard, server barebones).

Please see the support section of the online product page to check the current availability of these documents.

For More Information

For related product specifications, the latest firmware and software, and other information please visit our website at <http://www.gigabyte.com>



For GIGABYTE distributors and resellers, additional sales & marketing materials are available from our reseller portal: <http://reseller.b2b.gigabyte.com>

For further technical assistance, please contact your GIGABYTE representative or visit <https://esupport.gigabyte.com/> to create a new support ticket

For any general sales or marketing enquiries, you may also message GIGABYTE server directly by email: server.grp@gigabyte.com

Conventions

The following conventions are used in this user's guide:

| | |
|---|---|
|  | NOTE! Gives bits and pieces of additional information related to the current topic. |
|  | CAUTION! Gives precautionary measures to avoid possible hardware or software problems. |
|  | WARNING! Alerts you to any damage that might result from doing or not doing specific actions. |

Server Warnings and Cautions

Before installing a server, be sure that you understand the following warnings and cautions.



WARNING!

To reduce the risk of electric shock or damage to the equipment:

- Do not disable the power cord grounding plug. The grounding plug is an important safety feature.
- Plug the power cord into a grounded (earthed) electrical outlet that is easily accessible at all times.
- Unplug all the power cords from the power supplies to disconnect power to the equipment.

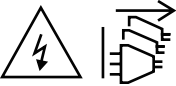

- Shock Hazard! Disconnect all power supply cords before servicing.
- Do not route the power cord where it can be walked on or pinched by items placed against it. Pay particular attention to the plug, electrical outlet, and the point where the cord extends from the server.



WARNING!

To reduce the risk of personal injury from hot surfaces, allow the drives and the internal system components to cool before touching them.



WARNING!

This server is equipped with high speed fans. Keep away from hazardous moving fan blades during servicing.



WARNING!

This equipment is not suitable for use in locations where children are likely to be present.



WARNING!

This equipment is intended to be used in Restrict Access Location. The access can only be gained by Skilled person.

Only authorized by well trained professional person can access the restrict access location.



CAUTION!

- Do not operate the server for long periods with the access panel open or removed. Operating the server in this manner results in improper airflow and improper cooling that can lead to thermal damage.
- Danger of explosion if battery is incorrectly replaced.
- Replace only with the same or equivalent type recommended by the manufacturer.
- Dispose of used batteries according to the manufacturer's instructions.

Electrostatic Discharge (ESD)



CAUTION!

ESD CAN DAMAGE DRIVES, BOARDS, AND OTHER PARTS. WE RECOMMEND THAT YOU PERFORM ALL PROCEDURES AT AN ESD WORKSTATION. IF ONE IS NOT AVAILABLE, PROVIDE SOME ESD PROTECTION BY WEARING AN ANTI-STATIC WRIST STRAP ATTACHED TO CHASSIS GROUND -- ANY UNPAINTED METAL SURFACE -- ON YOUR SERVER WHEN HANDLING PARTS.

Always handle boards carefully. They can be extremely sensitive to ESD. Hold boards only by their edges without any component and pin touching. After removing a board from its protective wrapper or from the system, place the board component side up on a grounded, static free surface. Use a conductive foam pad if available but not the board wrapper. Do not slide board over any surface.

System power on/off: To remove power from system, you must remove the system from rack. Make sure the system is removed from the rack before opening the chassis, adding, or removing any non hot-plug components.

Hazardous conditions, devices and cables: Hazardous electrical conditions may be present on power, telephone, and communication cables. Turn off the system and disconnect the cables attached to the system before servicing it. Otherwise, personal injury or equipment damage can result.

Electrostatic discharge (ESD) and ESD protection: ESD can damage drives, boards, and other parts. We recommend that you perform all procedures in this chapter only at an ESD workstation. If one is not available, provide some ESD protection by wearing an antistatic wrist strap attached to chassis ground (any unpainted metal surface on the server) when handling parts.

ESD and handling boards: Always handle boards carefully. They can be extremely sensitive to electrostatic discharge (ESD). Hold boards only by their edges. After removing a board from its protective wrapper or from the system, place the board component side up on a grounded, static free surface. Use a conductive foam pad if available but not the board wrapper. Do not slide board over any surface.

Installing or removing jumpers: A jumper is a small plastic encased conductor that slips over two jumper pins. Some jumpers have a small tab on top that can be gripped with fingertips or with a pair of fine needle nosed pliers. If the jumpers do not have such a tab, take care when using needle nosed pliers to remove or install a jumper; grip the narrow sides of the jumper with the pliers, never the wide sides. Gripping the wide sides can damage the contacts inside the jumper, causing intermittent problems with the function controlled by that jumper. Take care to grip with, but not squeeze, the pliers or other tool used to remove a jumper, or the pins on the board may bend or break.

**CAUTION!**

Risk of explosion if battery is replaced incorrectly or with an incorrect type. Replace the battery only with the same or equivalent type recommended by the manufacturer. Dispose of used batteries according to the manufacturer's instructions.

Table of Contents

| | |
|---|----|
| Chapter 1 Hardware Installation | 9 |
| 1-1 Installation Precautions | 9 |
| 1-2 Product Specifications | 10 |
| 1-3 System Block Diagram | 14 |
| Chapter 2 System Appearance | 15 |
| 2-1 Front View | 15 |
| 2-2 Rear View | 15 |
| 2-3 Front Panel LEDs and Buttons | 16 |
| 2-4 Power Supply Unit LED | 17 |
| 2-5 Hard Disk Drive LEDs | 18 |
| Chapter 3 System Hardware Installation | 19 |
| 3-1 System Compartments | 20 |
| 3-2 Removing and Installing the Chassis Cover | 21 |
| 3-3 Removing and Installing the Fan Duct | 22 |
| 3-4 Removing and Installing the Heat Sink | 23 |
| 3-5 Removing and Installing the CPU | 24 |
| 3-6 Removing and Installing Memory | 25 |
| 3-6-1 Eight-Channel Memory Configuration | 25 |
| 3-6-2 Removing and Installing a Memory Module | 26 |
| 3-6-3 Processor and Memory Module Matrix Table | 27 |
| 3-7 Removing and Installing the PCIe Card | 28 |
| 3-8 Removing and Installing the Hard Disk Drive | 30 |
| 3-9 Replacing the Fan Assembly | 31 |
| 3-10 Removing and Installing the Power Supply | 32 |
| 3-11 Installing and Removing an M.2 Solid State Drive | 33 |
| 3-12 Cable Routing | 34 |
| Chapter 4 Motherboard Components | 43 |
| 4-1 Motherboard Components | 43 |
| 4-2 Jumper Setting | 45 |
| 4-3 Backplane Board Storage Connector | 46 |
| 4-3-1 System Front HDD Backplane Board (CBP2007) | 46 |
| 4-3-2 System Rear HDD Backplane Board (CBP2022) | 46 |

| | |
|---|----|
| Chapter 5 BIOS Setup | 47 |
| 5-1 The Main Menu | 49 |
| 5-2 Advanced Menu | 51 |
| 5-2-1 Trusted Computing | 52 |
| 5-2-2 ACPI Settings | 53 |
| 5-2-3 APEI Configuration | 54 |
| 5-2-4 General Watchdog Timer | 55 |
| 5-2-5 X86 Emulator Configuration | 56 |
| 5-2-6 PCI Subsystem Settings | 57 |
| 5-2-7 Info Report Configuration | 64 |
| 5-2-8 USB Configuration | 65 |
| 5-2-9 Network Stack Configuration | 66 |
| 5-2-10 IP Configuration | 67 |
| 5-2-11 NVMe Configuration | 68 |
| 5-2-12 SATA Configuration | 69 |
| 5-2-13 Graphic Output Configuration | 70 |
| 5-2-14 Power Restore Configuration | 71 |
| 5-2-15 Intel(R) I350 Gigabit Network Connection | 72 |
| 5-2-16 MAC IPv4 Network Configuration | 74 |
| 5-2-17 MAC IPv6 Network Configuration | 75 |
| 5-2-18 Driver Health | 76 |
| 5-3 Chipset Setup Menu | 77 |
| 5-3-1 CPU Configuration | 78 |
| 5-3-2 RAS Configuration | 80 |
| 5-3-3 Memory Slot Information | 81 |
| 5-3-4 Serialport Console | 85 |
| 5-3-5 PCIE Root Complex Configuration | 86 |
| 5-4 Server Management Menu | 87 |
| 5-4-1 System Event Log | 88 |
| 5-4-2 BMC self test | 89 |
| 5-4-3 View FRU Information | 90 |
| 5-4-4 BMC Network Configuration | 91 |
| 5-5 Security Menu | 92 |
| 5-5-1 Media Sanitization | 93 |
| 5-5-2 Secure Boot | 94 |
| 5-6 Boot Menu | 96 |
| 5-7 Save & Exit Menu | 98 |
| 5-8 BIOS POST Beep code (AMI standard) | 99 |
| 5-8-1 PEI Beep Codes | 99 |
| 5-8-2 DXE Beep Codes | 99 |

Chapter 1 Hardware Installation

1-1 Installation Precautions

The motherboard/system contain numerous delicate electronic circuits and components which can become damaged as a result of electrostatic discharge (ESD). Prior to installation, carefully read the user manual and follow these procedures:







- Prior to installation, do not remove or break motherboard S/N (Serial Number) sticker or warranty sticker provided by your dealer. These stickers are required for warranty validation.
- Always remove the AC power by unplugging the power cord from the power outlet before installing or removing the motherboard or other hardware components.
- When connecting hardware components to the internal connectors on the motherboard, make sure they are connected tightly and securely.
- When handling the motherboard, avoid touching any metal leads or connectors.
- It is best to wear an electrostatic discharge (ESD) wrist strap when handling electronic components such as a motherboard, CPU or memory. If you do not have an ESD wrist strap, keep your hands dry and first touch a metal object to eliminate static electricity.
- Prior to installing the motherboard, please have it on top of an antistatic pad or within an electrostatic shielding container.
- Before unplugging the power supply cable from the motherboard, make sure the power supply has been turned off.
- Before turning on the power, make sure the power supply voltage has been set according to the local voltage standard.
- Before using the product, please verify that all cables and power connectors of your hardware components are connected.
- To prevent damage to the motherboard, do not allow screws to come in contact with the motherboard circuit or its components.
- Make sure there are no leftover screws or metal components placed on the motherboard or within the computer casing.
- Do not place the computer system on an uneven surface.
- Do not place the computer system in a high-temperature environment.
- Turning on the computer power during the installation process can lead to damage to system components as well as physical harm to the user.
- If you are uncertain about any installation steps or have a problem related to the use of the product, please consult a certified computer technician.

1-2 Product Specifications



NOTE:

We reserve the right to make any changes to the product specifications and product-related information without prior notice.

| | |
|--|--|
|  CPU | <ul style="list-style-type: none">◆ Ampere® Altra® Max Processor◆ Dual processors, 7nm technology◆ Up to 128-core per processor, TDP 250W <p>NOTE: If only 1 CPU is installed, some PCIe or memory functions might be unavailable</p> |
|  Socket | <ul style="list-style-type: none">◆ Dual sockets◆ LGA4926 |
|  Chipset | <ul style="list-style-type: none">◆ System on Chip |
|  Memory | <ul style="list-style-type: none">◆ 32 x DIMM slots◆ DDR4 memory supported only◆ 8-Channel memory architecture◆ RDIMM modules up to 256GB supported◆ LRDIMM modules up to 256GB supported◆ Up to 4TB of memory capacity supported per processor◆ Memory speed: Up to 3200 MHz <p>NOTE: Only supports configurations with 1, 2, 4, 6, 8, 12, or 16 DIMMs</p> |
|  LAN | <ul style="list-style-type: none">◆ 2 x 1Gb/s LAN ports (1 x Intel® I350-AM2)◆ NCSI function supported◆ 1 x 10/100/1000 Mbps management LAN |
|  Video | <ul style="list-style-type: none">◆ Integrated in Aspeed® AST2600◆ 2D Video Graphic Adapter with PCIe bus interface◆ 1920x1200@60Hz 32bpp, DDR4 SDRAM |
|  Storage | <ul style="list-style-type: none">◆ Front side: 24 x 2.5" Gen4 NVMe hot-swappable bays◆ Rear side: 4 x 2.5" SATA hot-swappable bays, from onboard SATA controller (asmedia ASM1166) |



Expansion Slot

Riser Card CRS101J:

- ◆ 1 x PCIe x16 slot (Gen4 x16), Full height half-length

Riser Card CRS101K:

- ◆ 1 x PCIe x16 slot (Gen4 x16), Full height half-length

Riser Card CRS202G:

- ◆ 1 x PCIe x16 slot (Gen4 x16), Full height half-length

NOTE: 1 PCIe slot is disabled

- ◆ **Riser Card CRS202H:**

- ◆ 1 x PCIe x16 slot (Gen4 x16), Full height full-length

NOTE: 1 PCIe slot is disabled

2 x OCP 3.0 Gen4 x16 mezzanine slots (Disabled)

1 x M.2 slots:

- ◆ M-key
- ◆ PCIe Gen4 x4
- ◆ Supports 2242/2260/2280/22110 cards



Internal I/O

- ◆ 1 x M.2 slot
- ◆ 1 x TPM header
- ◆ 1 x Front panel header
- ◆ 1 x HDD/SSD back plane board header
- ◆ 1 x PMBus connector
- ◆ 1 x IPMB connector
- ◆ 1 x Clear CMOS jumper



Front I/O

- ◆ 2 x USB 3.2 Gen1
- ◆ 1 x Power button with LED
- ◆ 1 x ID button with LED
- ◆ 1 x Reset button
- ◆ 2 x LAN activity LEDs
- ◆ 1 x HDD activity LED
- ◆ 1 x System status LED



Rear I/O

- ◆ 2 x USB 3.2 Gen1
- ◆ 1 x mini-DP
- ◆ 2 x RJ45
- ◆ 1 x MLAN



Backplane I/O

- ◆ Front side_CBP2007: 24 x Gen4 U.2 ports
- ◆ Rear side_CBP2022: 2 x SATA ports
- ◆ Speed and bandwidth: PCIe Gen4 x4 or SATA



TPM

- ◆ 1 x TPM header with SPI interface
- ◆ Optional TPM2.0 kit: CTM010



Power Supply

- ◆ 2 x 1600W power supply
- ◆ 80 PLUS Platinum

AC Input:

- ◆ 100-120V~/ 12A, 50-60Hz
- ◆ 200-240V~/ 10A, 50-60Hz

◆ DC Input:

- 40Vdc/ 4.5A

DC Output:

- ◆ Max 1000W/ 100-120V~
- ◆ +12V/ 81.5A
- ◆ +12Vsb/ 2.5A
- ◆ - Max 1600W/ 200-240V or 240Vdc Input
- ◆ +12V/ 133A
- ◆ +12Vsb/ 2.5A



System Management

- ◆ Aspeed® AST2600 management controller
- ◆ GIGABYTE Management Console (AMI MegaRAC SP-X) web interface

- ◆ Dashboard
- ◆ HTML5 KVM
- ◆ Sensor Monitor (Voltage, RPM, Temperature, CPU Status ...etc.)
- ◆ Sensor Reading History Data
- ◆ FRU Information
- ◆ SEL Log in Linear Storage / Circular Storage Policy
- ◆ Hardware Inventory
- ◆ Fan Profile
- ◆ System Firewall
- ◆ Power Consumption
- ◆ Power Control
- ◆ LDAP / AD / RADIUS Support
- ◆ Backup & Restore Configuration
- ◆ Remote BIOS/BMC/CPLD Update
- ◆ Event Log Filter
- ◆ User Management
- ◆ Media Redirection Settings
- ◆ PAM Order Settings
- ◆ SSL Settings
- ◆ SMTP Settings



Operating Properties

- ◆ Operating temperature: 10°C to 35°C
- ◆ Operating humidity: 8%-80% (non-condensing)
- ◆ Non-operating temperature: -40°C to 60°C
- ◆ Non-operating humidity: 20%-95% (non-condensing)



System

- ◆ 2U

Dimension

- ◆ 438mm (W) x 87mm (H) x 730mm (D)

1-3 System Block Diagram

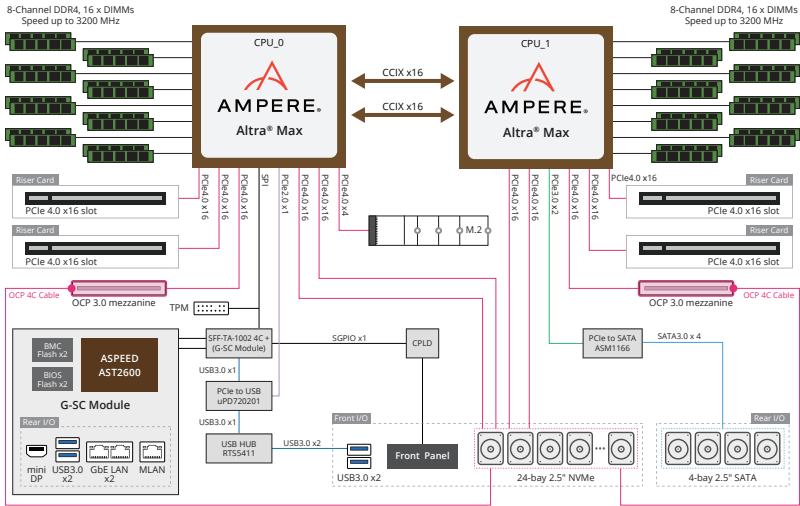

Chapter 2 System Appearance

2-1 Front View

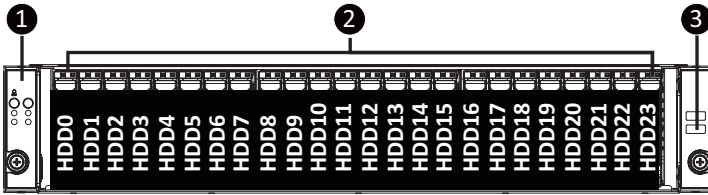

| No. | Description |
|--|------------------------------|
| 1. | Front Panel LEDs and Buttons |
| 2. | 2.5" HDD Bays |
| 3. | Front USB 3.0 Ports |
| NOTE! The Green Latch Supports NVMe | |



- Refer to section **2-3 Front Panel LEDs and Buttons** for a detailed description of the function of the LEDs.

2-2 Rear View

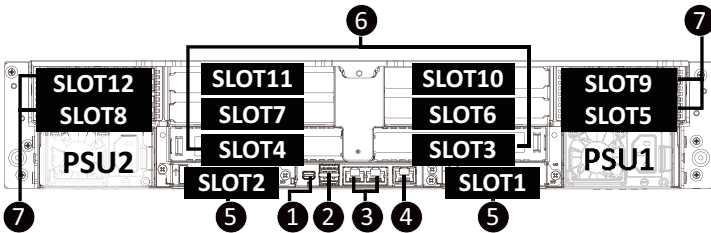

| No. | Description | No. | Description |
|-----|----------------------------|-----|----------------------|
| 1. | Mini DP Port | 5. | NVMe SSD Slot |
| 2. | USB 3.0 Port x 2 | 6. | PCIe Slot |
| 3. | 1GbE LAN Port x 2 | 7. | 2.5" SATA Hard Drive |
| 4. | Server Management LAN Port | -- | -- |

2-3 Front Panel LEDs and Buttons

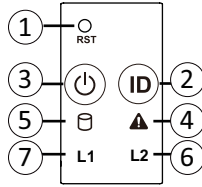

| No. | Name | Color | Status | Description |
|------|------------------------|-----------------|--------|--|
| 1. | Reset Button | -- | -- | Press this button to reset the system. |
| 2. | ID Button with LED | Blue | On | Indicates the system identification is active. |
| | | N/A | Off | Indicates the system identification is disabled. |
| 3. | Power button with LED | Green | On | Indicates the system is powered on. |
| | | Green | Blink | System is in ACPI S1 state (sleep mode). |
| | | N/A | Off | - System is not powered on or in ACPI S5 state (power off) - System is in ACPI S4 state (hibernate mode) |
| 4. | System Status LED | Green | On | Indicates system is operating normally. |
| | | Amber | On | Indicates a critical condition, may include: - System fan failure - System temperature |
| | | | Blink | Indicates non-critical condition, may include: - Redundant power module failure - Temperature and voltage issue - Chassis intrusion |
| | | N/A | Off | Indicates system is not ready, may include: - POST error - NMI error - Processor or terminator is missing |
| 5. | HDD Status LED | Green | On | Indicates locating the HDD. |
| | | | Blink | Indicates accessing the HDD. |
| | | Amber | On | Indicates HDD error. |
| | | Green/ Amber | Blink | Indicates HDD rebuilding. |
| | | N/A | Off | Indicates no HDD access or no HDD error. |
| 6/7. | LAN1/2 Active/Link LED | Green | On | Indicates a link between the system and the network or no access. |
| | | Green | Blink | Indicates data transmission or receiving is occurring. |
| | | N/A | Off | Indicates no data transmission or receiving is occurring. |

2-4 Power Supply Unit LED

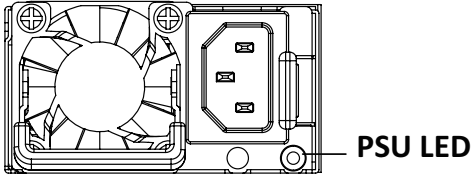

| State | Description |
|----------------------|---|
| OFF | No AC power to all power supplies |
| 0.5Hz Green Blinking | AC present / only standby on / Cold redundant mode |
| 2Hz Green Blinking | Power supply firmware updateing mode |
| Amber | AC cord unplugged or AC power lost; with a second power supply in parallel still with AC input power |
| | Power supply critical event causing shut down: failure, OCP, OVP, fan failure and UVP |
| 0.5Hz Amber Blinking | Power supply warning events where the power supply continues to operate: high temp, high power, high current and slow fan |

2-5 Hard Disk Drive LEDs

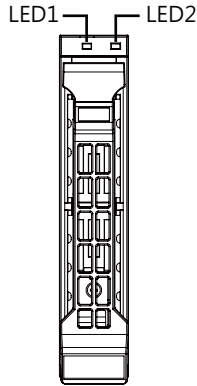

| RAID SKU | | LED #1 | Locate | HDD Fault | Rebuilding | HDD Access | HDD Present (No Access) |
|---|--------------------------------------|--------|--------|-----------|-------------------|------------|-------------------------|
| No RAID configuration (via HBA) | Disk LED (LED on Back Panel) | Green | ON(*1) | OFF | | BLINK (*2) | OFF |
| | | Amber | OFF | OFF | | OFF | OFF |
| | Removed HDD Slot (LED on Back Panel) | Green | ON(*1) | OFF | | -- | -- |
| | | Amber | OFF | OFF | | -- | -- |
| RAID configuration (via HW RAID Card or SW RAID Card) | Disk LED | Green | ON | OFF | | BLINK (*2) | OFF |
| | | Amber | OFF | ON | (Low Speed: 2 Hz) | OFF | OFF |
| | Removed HDD Slot | Green | ON(*1) | OFF | (*3) | -- | -- |
| | | Amber | OFF | ON | (*3) | -- | -- |

| LED #2 | HDD Present | No HDD |
|--------|-------------|--------|
| Green | ON | OFF |

NOTE:

*1: Depends on HBA/Utility Spec.

*2: Blink cycle depends on HDD's activity signal.

*3: If HDD is pulled out during rebuilding, the disk status of this HDD is regarded as faulty.

Chapter 3 System Hardware Installation



Pre-installation Instructions

Computer components and electronic circuit boards can be damaged by discharges of static electricity. Working on computers that are still connected to a power supply can be extremely dangerous. Follow the simple guidelines below to avoid damage to your computer or injury to yourself.

- Always disconnect the computer from the power outlet whenever you are working inside the computer case.
- If possible, wear a grounded wrist strap when you are working inside the computer case. Alternatively, discharge any static electricity by touching the bare metal system of the computer case, or the bare metal body of any other grounded appliance.
- Hold electronic circuit boards by the edges only. Do not touch the components on the board unless it is necessary to do so. Do not flex or stress the circuit board.
- Leave all components inside the static-proof packaging until you are ready to use the component for the installation.

3-1 System Compartments

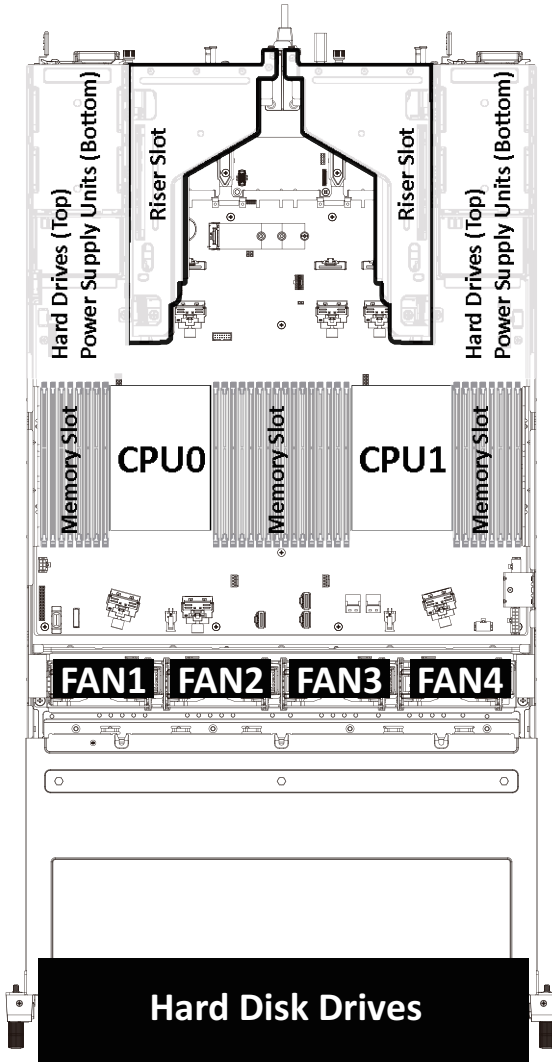

3-2 Removing and Installing the Chassis Cover



Before you remove or install the system cover

- Make sure the system is not turned on or connected to AC power.

Follow these instructions to remove the chassis cover:

1. Remove the screw on the top cover.
2. Unlock the plastic handle and pull the grip handle to open the panel cover.
3. Slide the cover cover to the rear of the system and then remove the cover in the direction indicated by the arrow.
4. To reinstall the chassis cover reverse steps 1-3.

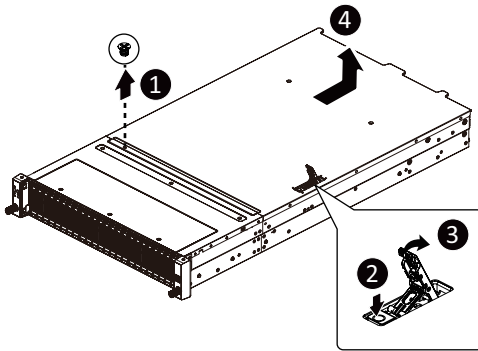

3-3 Removing and Installing the Fan Duct

Follow these instructions to remove the fan duct:

1. Lift up to remove the fan duct.
2. To reinstall the fan duct, align the fan duct with the guiding groove. Push down the fan duct until it is firmly seated on the system.

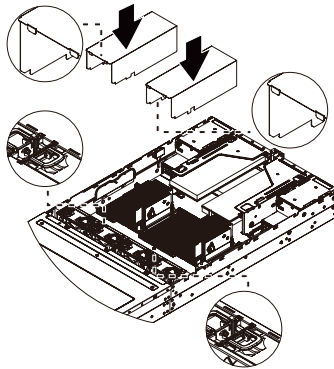
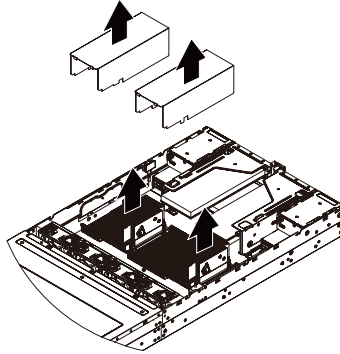

3-4 Removing and Installing the Heat Sink



Read the following guidelines before you begin to install the heat sink:

- Always turn off the computer and unplug the power cord from the power outlet before installing the heat sink to prevent hardware damage.
- Unplug all cables from the power outlets.
- Disconnect all telecommunication cables from their ports.
- Place the system unit on a flat and stable surface.
- Open the system according to the instructions.



WARNING!

Failure to turn off the server before you start installing components may cause serious damage. Do not attempt the procedures described in the following sections unless you are a qualified service technician.

Follow these instructions to install the heat sink:

1. Loosen the screws securing the heat sink in place in reverse order (4→3→2→1).
2. Lift and remove the heat sink from the system.
3. To install the heat sink, reverse steps 1-2 while ensuring that you tighten the captive screws in sequential order (1→2→3→4) as seen in the image below.

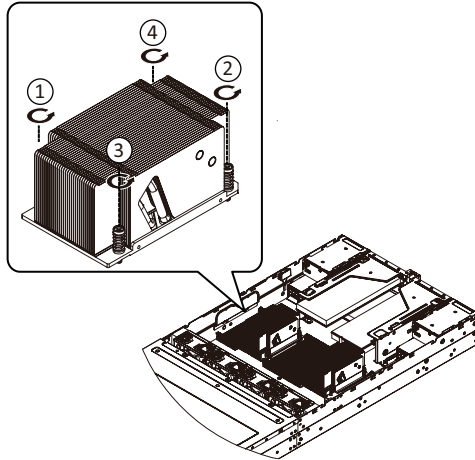

3-5 Removing and Installing the CPU



Read the following guidelines before you begin to install the CPU:

- Make sure that the motherboard supports the CPU.
- Always turn off the computer and unplug the power cord from the power outlet before installing the CPU to prevent hardware damage.
- Unplug all cables from the power outlets.
- Disconnect all telecommunication cables from their ports.
- Place the system unit on a flat and stable surface.
- Open the system according to the instructions.



WARNING!

Failure to properly turn off the server before you start installing components may cause serious damage. Do not attempt the procedures described in the following sections unless you are a qualified service technician.

Follow these instructions to install the CPU:

1. Loosen the three captive screws securing the CPU cover in sequential order (1→2→3→4→5).
2. Flip open the CPU cover.
3. Remove the CPU carrier from the CPU frame using the handle on the CPU carrier.
4. Install the CPU into place in the CPU socket.
5. Flip the CPU cover into place over the CPU socket.
6. Tighten the CPU cover screws in sequential order (1→2→3→4→5) to secure the CPU cover in place.
7. To remove the CPUs, follow steps 1-6 in reverse order.



- When installing the heat sink over the CPU, use Phillip#2 driver to tighten the 4 captive nuts in sequential order (1→2→3→4).The screw tightening torque: 10.0 kgf-cm

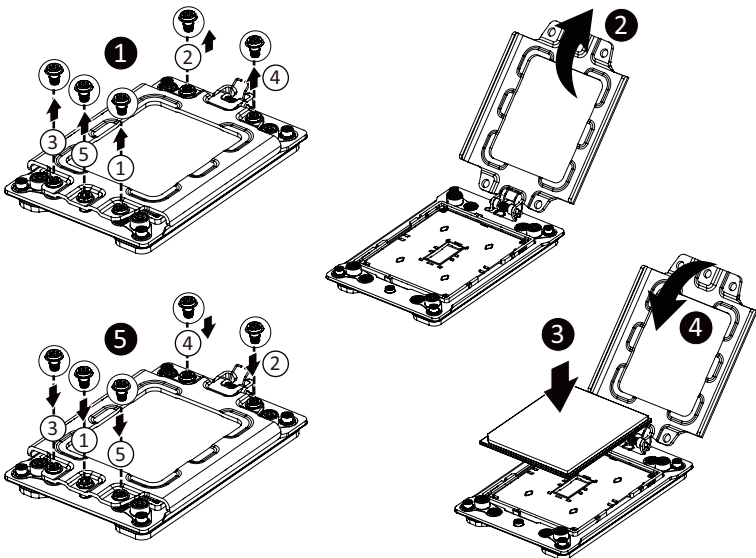

3-6 Removing and Installing Memory



Read the following guidelines before you begin to install the memory:

- Make sure that the motherboard supports the memory. It is recommended that memory of the same capacity, brand, speed, and chips be used.
- Always turn off the computer and unplug the power cord from the power outlet before installing the memory to prevent hardware damage.
- Memory modules have a foolproof design. A memory module can be installed in only one direction. If you are unable to insert the memory, switch the direction.

3-6-1 Eight-Channel Memory Configuration

This motherboard provides 32 DDR4 memory sockets and supports Eight Channel Technology. After the memory is installed, the BIOS will automatically detect the specifications and capacity of the memory.

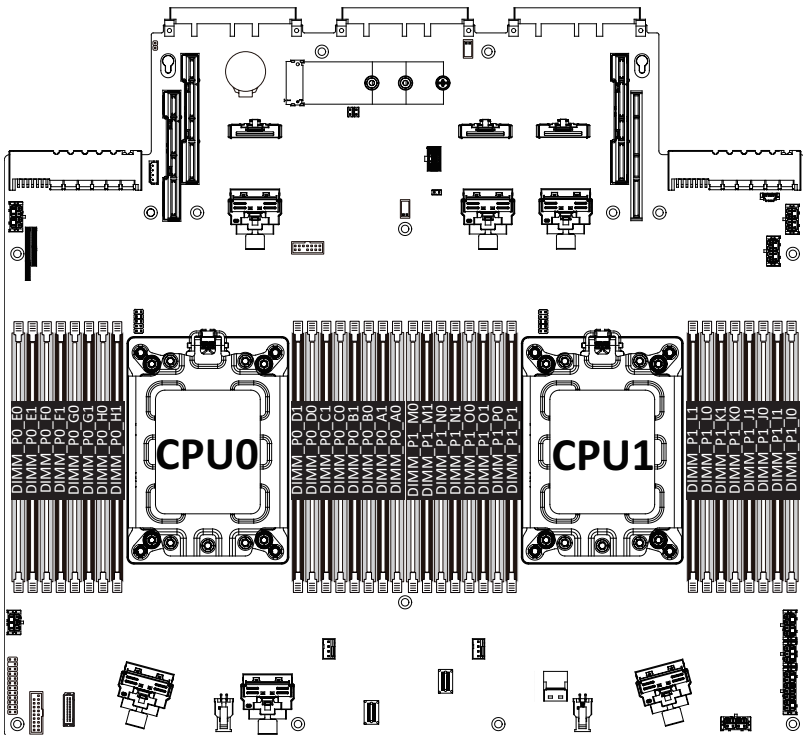

3-6-2 Removing and Installing a Memory Module



Before installing a memory module, make sure to turn off the computer and unplug the power cord from the power outlet to prevent damage to the memory module. Be sure to install DDR4 DIMMs on to this motherboard.

Follow these instructions to install a DIMM module:

1. Insert the DIMM memory module vertically into the DIMM slot and push it down.
2. Close the plastic clip at both edges of the DIMM slots to lock the DIMM module.
3. Reverse the installation steps when you want to remove the DIMM module.

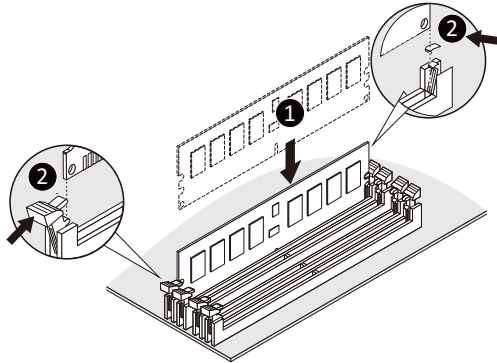

3-6-3 Processor and Memory Module Matrix Table

| Memory Q'ty for each CPU | CPU0 | | | | | | | | | | | | | | | |
|-----------------------------|------|----|----|----|----|----|----|----|----|----|----|----|----|----|----|----|
| | E0 | E1 | F0 | F1 | G0 | G1 | H0 | H1 | D1 | D0 | C1 | C0 | B1 | B0 | A1 | A0 |
| 1 DIMM | | | | | | | | | | | | | | | | V |
| 2 DIMM | V | | | | | | | | | | | | | | | V |
| 4 DIMM | V | | V | | | | | | | | | | | V | | V |
| 6 DIMM | V | | V | | V | | | | | | | V | | V | | V |
| 8 DIMM | V | | V | | V | | V | | | V | | V | | V | | V |
| 12 DIMM | V | V | V | V | V | V | | | | | V | V | V | V | V | V |
| 16 DIMM | V | V | V | V | V | V | V | V | V | V | V | V | V | V | V | V |
| Memory Q'ty for each CPU | CPU1 | | | | | | | | | | | | | | | |
| | M0 | M1 | N0 | N1 | O0 | O1 | P0 | P1 | L1 | L0 | K1 | K0 | J1 | J0 | I1 | I0 |
| 1 DIMM | | | | | | | | | | | | | | | | V |
| 2 DIMM | V | | | | | | | | | | | | | | | V |
| 4 DIMM | V | | V | | | | | | | | | | | V | | V |
| 6 DIMM | V | | V | | V | | | | | | | V | | V | | V |
| 8 DIMM | V | | V | | V | | V | | | V | | V | | V | | V |
| 12 DIMM | V | V | V | V | V | V | | | | | V | V | V | V | V | V |
| 16 DIMM | V | V | V | V | V | V | V | V | V | V | V | V | V | V | V | V |

3-7 Removing and Installing the PCIe Card



- Voltages can be present within the server whenever an AC power source is connected. This voltage is present even when the main power switch is in the off position. Ensure that the system is powered off and all power sources have been disconnected from the server prior to installing a PCIe card.
- Failure to observe these warnings could result in personal injury or damage to equipment.



- The PCIe riser assembly does not include a riser card or any cabling as standard. To install a PCIe card, a riser card must be installed.

Follow these instructions to install a PCIe card:

1. Loosen the thumbnail screw securing the riser bracket from the rear side of the system.
 2. Loosen the two thumbnail screws securing the riser bracket inside the system.
 3. Lift up the riser bracket out of system.
 4. Remove the screw securing the slot cover from riser bracket.
 5. Orient the PCIe card with the riser guide slot and push in the direction of the arrow until the PCIe card sits in the PCIe card connector.
- NOTE:** Some riser brackets allow for single or multiple PCIe cards.
Repeat steps 4-5 as necessary.
6. Secure the PCIe card with the screw.
 7. Repeat steps 1-3 to install the PCIe card into the system.

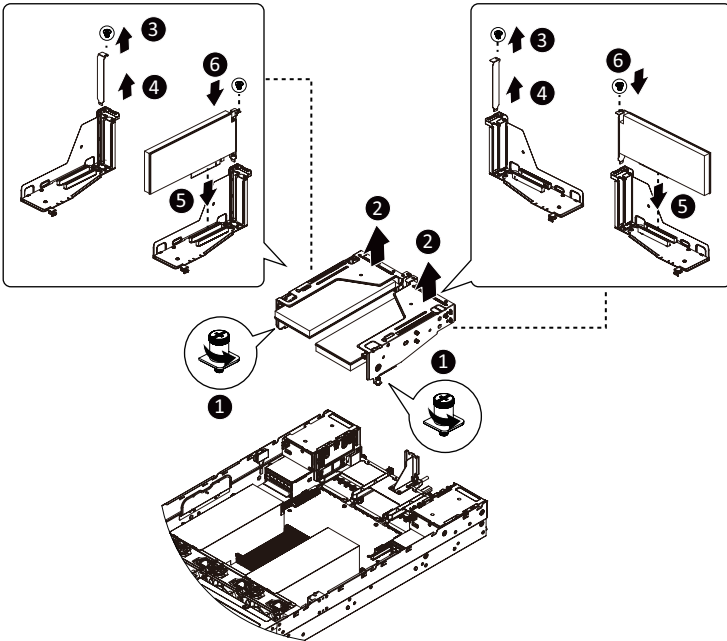

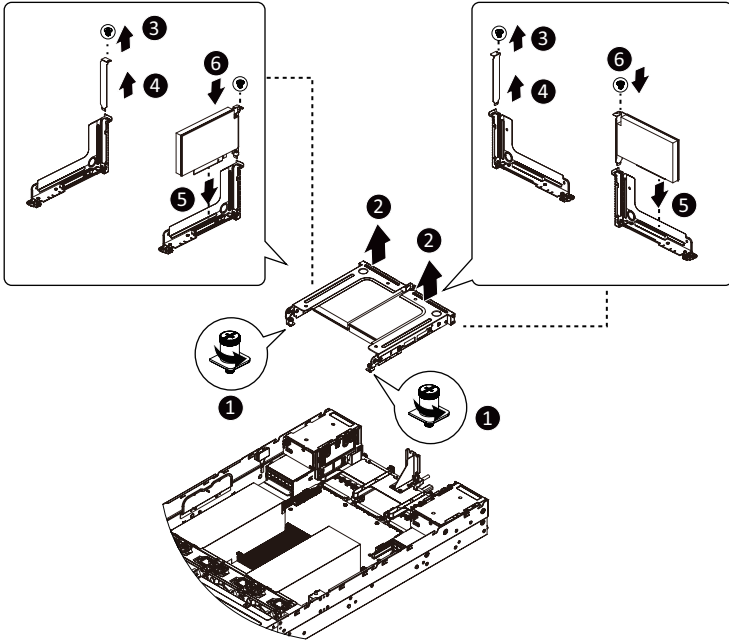

3-8 Removing and Installing the Hard Disk Drive



Read the following guidelines before you begin to install the hard disk drive:

- Take note of the HDD tray orientation before sliding it out.
- The tray will not fit back into the bay if it is inserted incorrectly.
- Make sure that the hard disk drive is connected to the connector on the backplane.

Follow these instructions to install a 2.5" hard disk drive:

1. Press the release button.
2. Extend the locking lever.
3. Pull the locking lever in the direction indicated to remove the HDD tray.
4. Align the hard disk drive with the positioning stud on the HDD tray.
5. Slide the hard disk drive into the HDD tray.
6. Reinsert the HDD tray into the slot and close the locking lever.

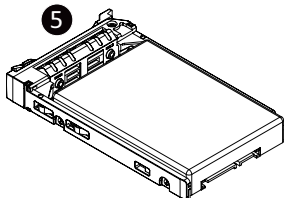
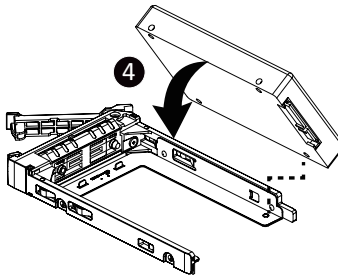
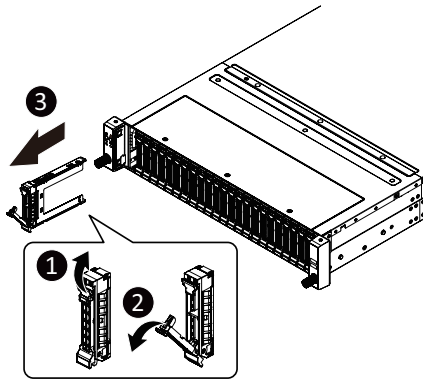

3-9 Replacing the Fan Assembly



- Voltages can be present within the server whenever an AC power source is connected. This voltage is present even when the main power switch is in the off position. Ensure that the system is powered-down and all power sources have been disconnected from the server prior to replacing a system fan.

Failure to observe these warnings could result in personal injury or damage to equipment.

Follow these instructions to replace a fan assembly:

1. Flip the latches on the top of the fan outwards.
2. Using the latches, lift up the fan assembly from the chassis.
3. Reverse the previous steps to install the replacement fan assembly.

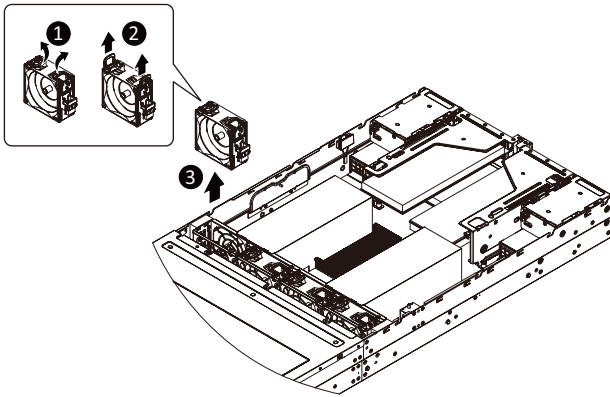

3-10 Removing and Installing the Power Supply

Follow these instructions to replace the power supply:

1. Flip up and then grasp the power supply handle.
2. Press the retaining clip on the right side of the power supply unit in the direction indicated.
3. Pull out the power supply unit using the handle.
4. Insert the replacement power supply unit firmly into the chassis. Connect the AC power cord to the replacement power supply.
5. Repeat steps 1-4 for replacement of the second power supply.

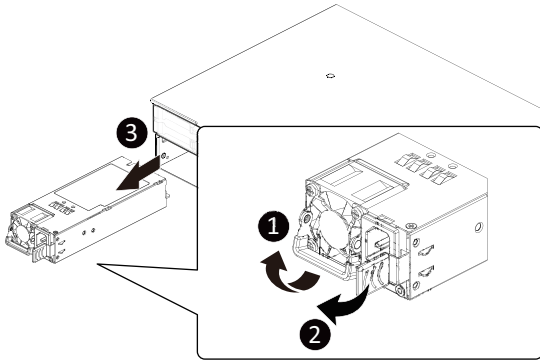

3-11 Installing and Removing an M.2 Solid State Drive

Follow these instructions to install an optional M.2 solid state drive (SSD):



NOTE:

To install/remove the M.2 heatsink use a No. 1 Phillips-head screwdriver with a screw torque of $1.5 \pm 0.2 \text{ kg}^* \text{cm}$

1. Place the solid state drive into the M.2 connector.
2. Secure the solid state drive to the motherboard with a single screw.

NOTE: The position of the screw will depend on the size of the SSD. Refer to the second image below for proper placement.

3. Reverse steps 1-2 to remove the solid state drive.

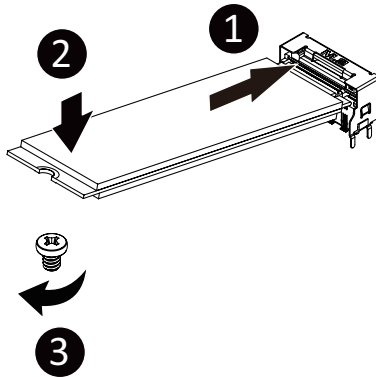

3-12 Cable Routing

Front Panel USB 3.0 Ports Cable

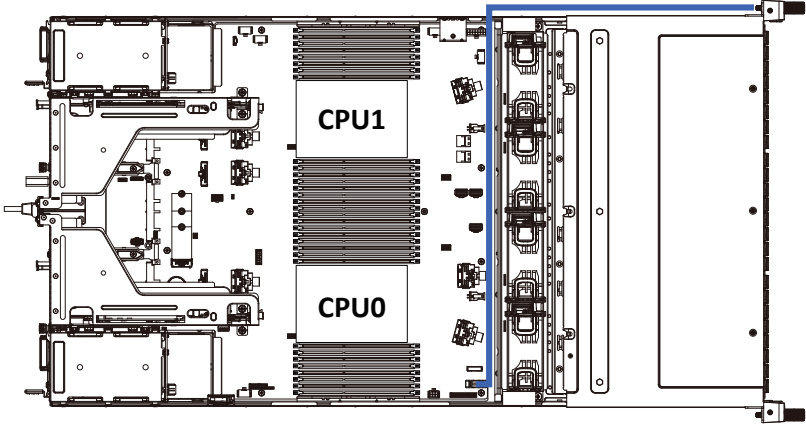

Front Panel LEDs and Buttons Cable

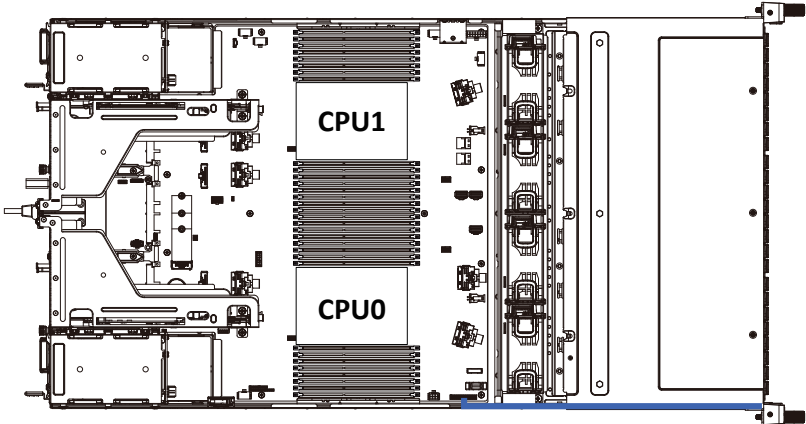

Motherboard Power Cable

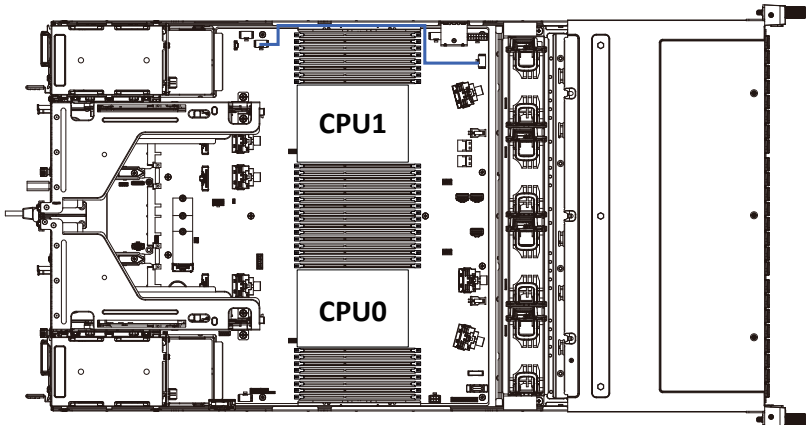

Rear HDD Backplane Board Power Cable

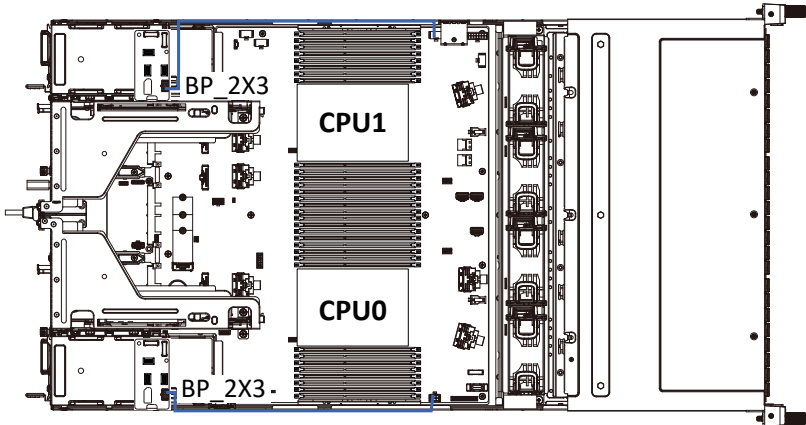

HDD Backplane Board Signal Cable

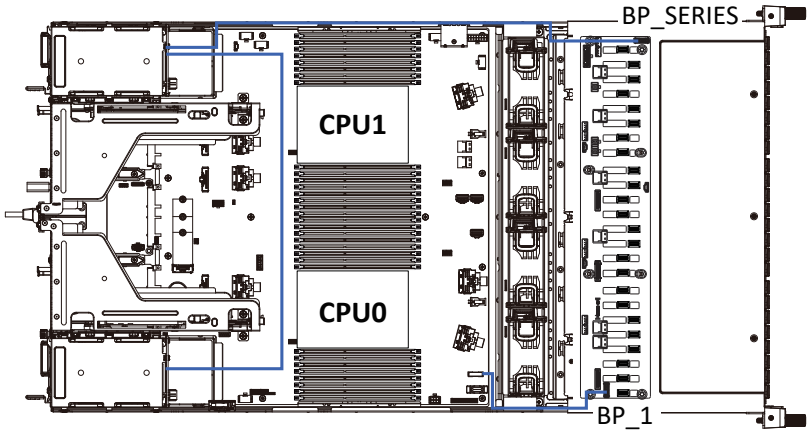

HDD Backplane Board Power Cable

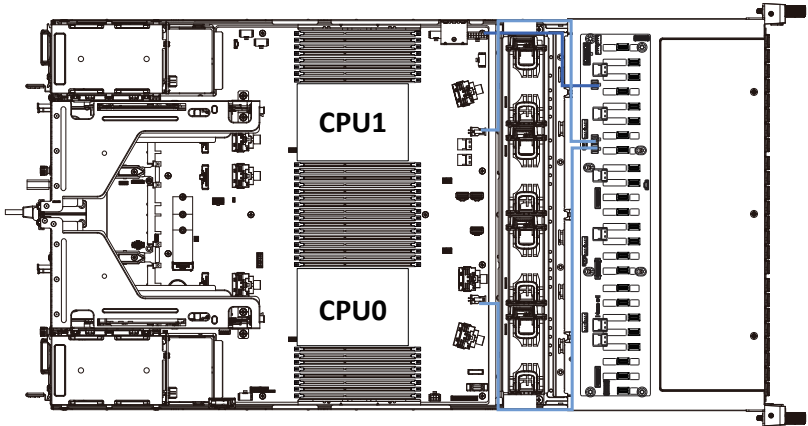

NVMe 0-3 Cable

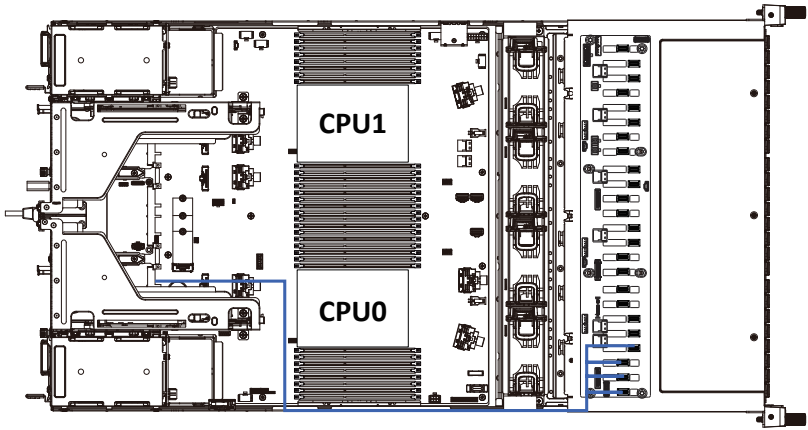

NVMe 4-5 Cable

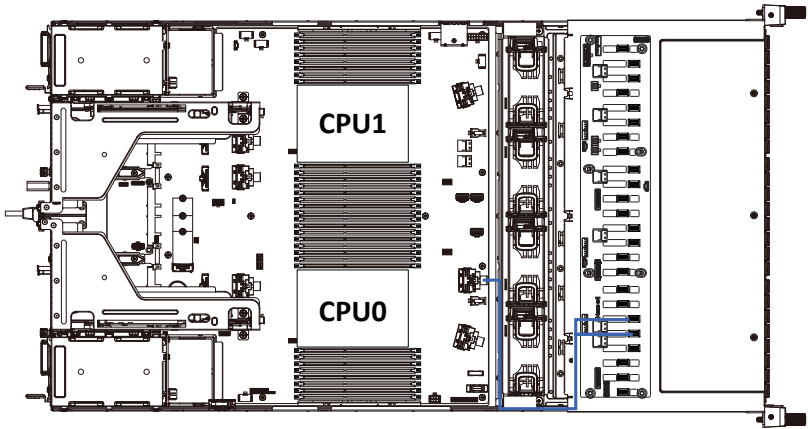

NVMe 6-7 Cable

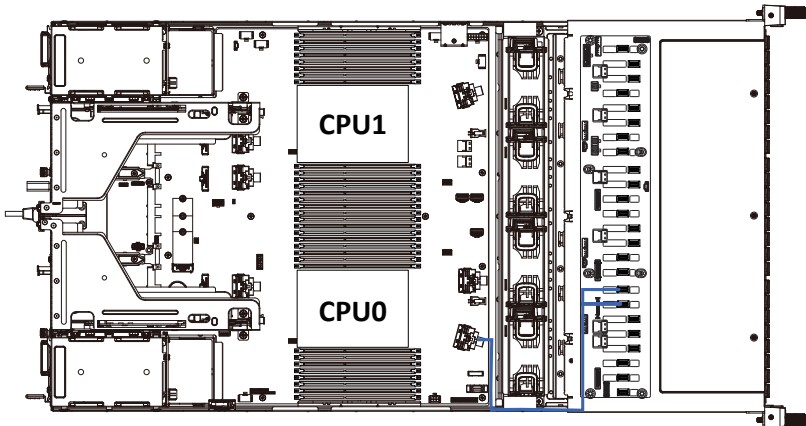

NVMe 8-9 Cable

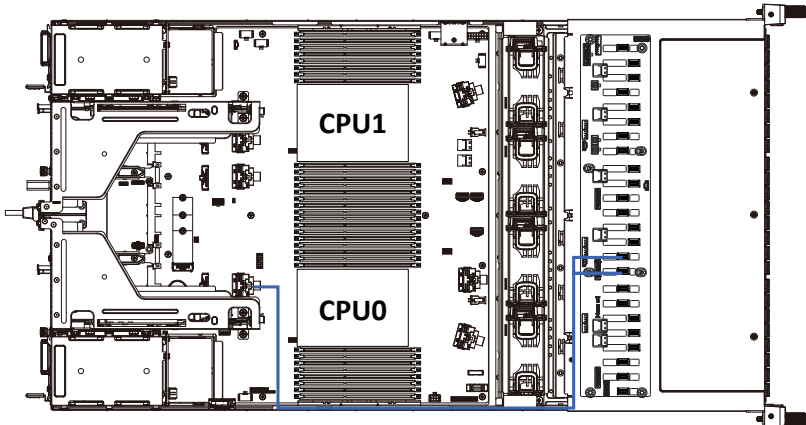

NVMe 10-11 Cable

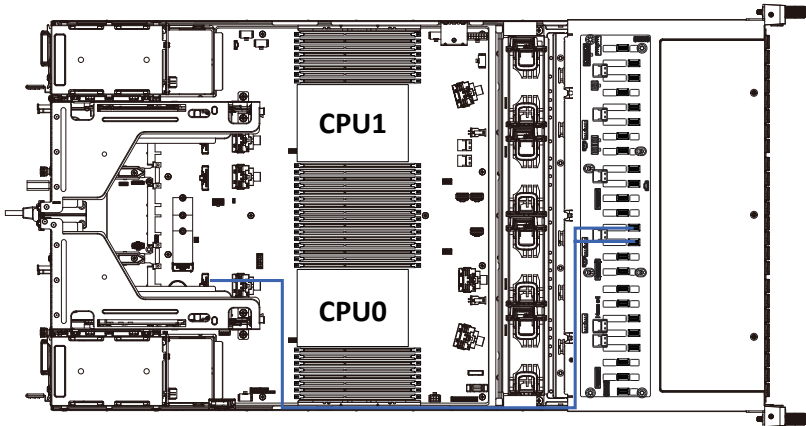

NVMe 12-13 Cable

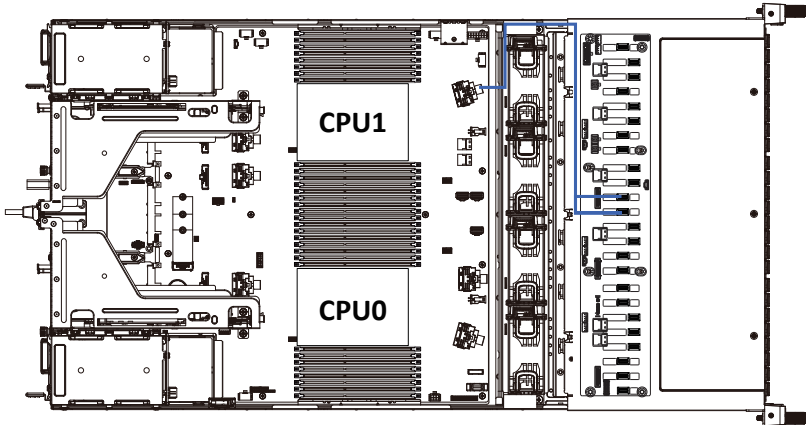

NVMe 14-15 Cable

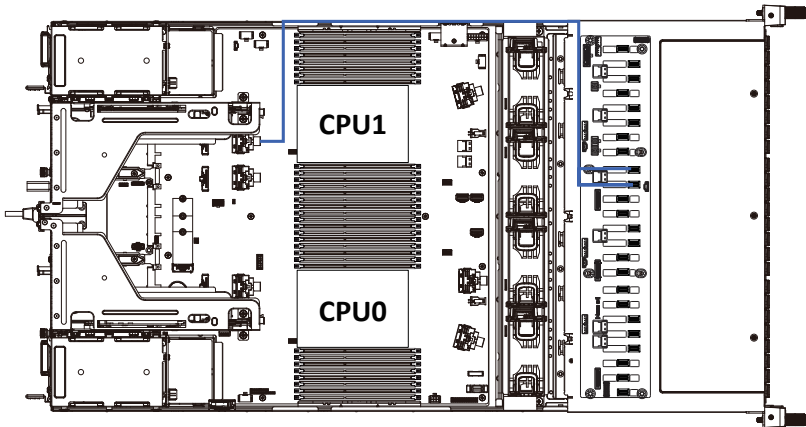

NVMe 16-17 Cable

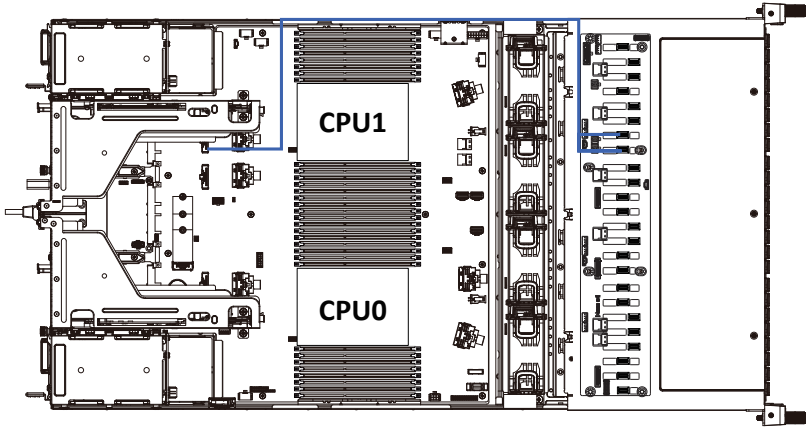

NVMe 18-19 Cable

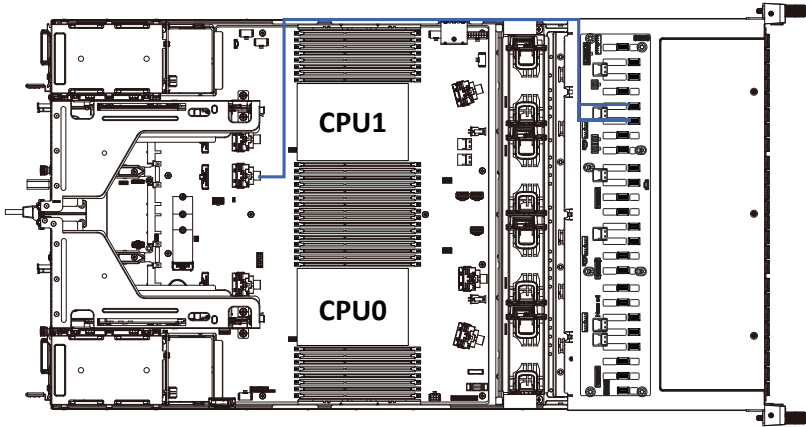

NVMe 20-23 Cable

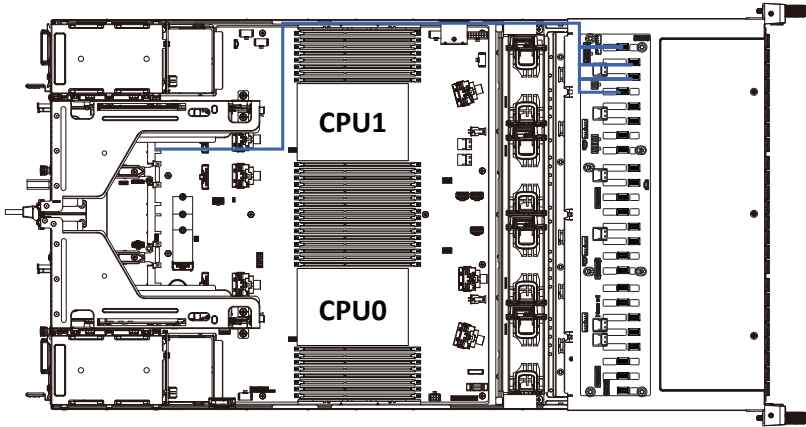

On-Board SATA Cable

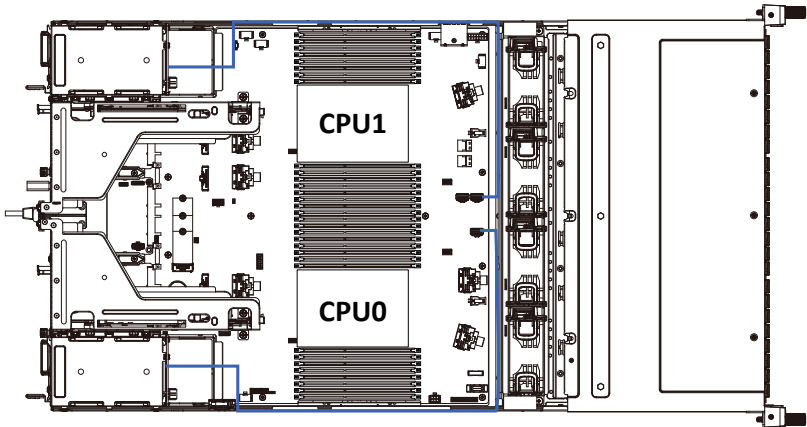

Chapter 4 Motherboard Components

4-1 Motherboard Components

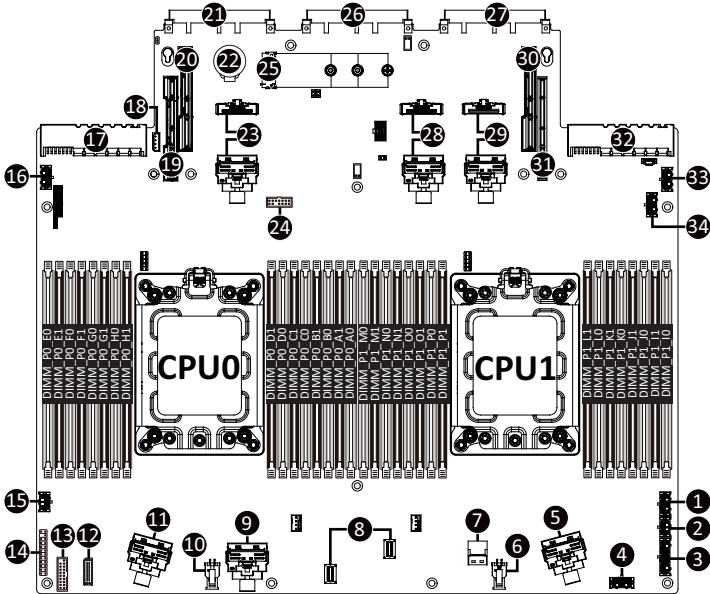

| Item | Description |
|------|---|
| 1 | 2 x 4 Pin P12V GPU Power Connector |
| 2 | 2 x 3 Pin Power Connector |
| 3 | 2 x 7 Pin Power Connector |
| 4 | 2 x 4 Pin P12V Power Connector |
| 5 | MCIO Connector (MCIO_P1_3/PCIe Gen4) |
| 6 | 2 x 2 Pin P12V Backplane Power Connector |
| 7 | SlimLine SAS Connector (MCIO_P1_22/PCIe Gen4) |
| 8 | SlimLine SAS Connectors |
| 9 | MCIO Connector (MCIO_P0_1/PCIe Gen4) |
| 10 | 2 x 2 Pin P12V Backplane Power Connector |
| 11 | MCIO Connector (MCIO_P0_0/PCIe Gen4) |
| 12 | HDD Backplane Board Connector |
| 13 | Front Panel USB 3.0 Connector |
| 14 | Front Panel Header |
| 15 | 2 x 3 Pin Power Connector |
| 16 | 2 x 4 Pin P12V GPU Power Connector |
| 17 | Power Supply Connector#1 (Primary) |
| 18 | IPMB Connector |

| | |
|----|---|
| 19 | Riser Connector #1 (PCIe Gen4/x16 Slot) |
| 20 | Riser Connector #2 (PCIe Gen4/x16 Slot) |
| 21 | OCP Mezzanine Connector (OCP 3.0/SFF Type/Gen4 x16) |
| 22 | RTC Battery |
| 23 | MCIO Connectors (MCIO_P0_2/MCIO_P0_3/PCIe Gen4) |
| 24 | TPM Module Connector (SPI Interface) |
| 25 | M.2 Slot (PCIe Gen4 x4, Support NGFF-22110) |
| 26 | G-SCM Module Connector |
| 27 | OCP Mezzanine Connector (OCP 3.0/SFF Type/Gen4 x16) |
| 28 | MCIO Connectors (MCIO_P1_4/MCIO_P1_5/PCIe Gen4) |
| 29 | MCIO Connectors (MCIO_P1_0/MCIO_P1_1/PCIe Gen4) |
| 30 | Riser Connector #3 (PCIe Gen4/x16 Slot) |
| 31 | Riser Connector #4 (PCIe Gen4/x16 Slot) |
| 32 | Power Supply Connector#2 (Secondary) |
| 33 | 2 x 4 Pin P12V GPU Power Connector |
| 34 | 2 x 4 Pin P12V Power Connector |

4-2 Jumper Setting

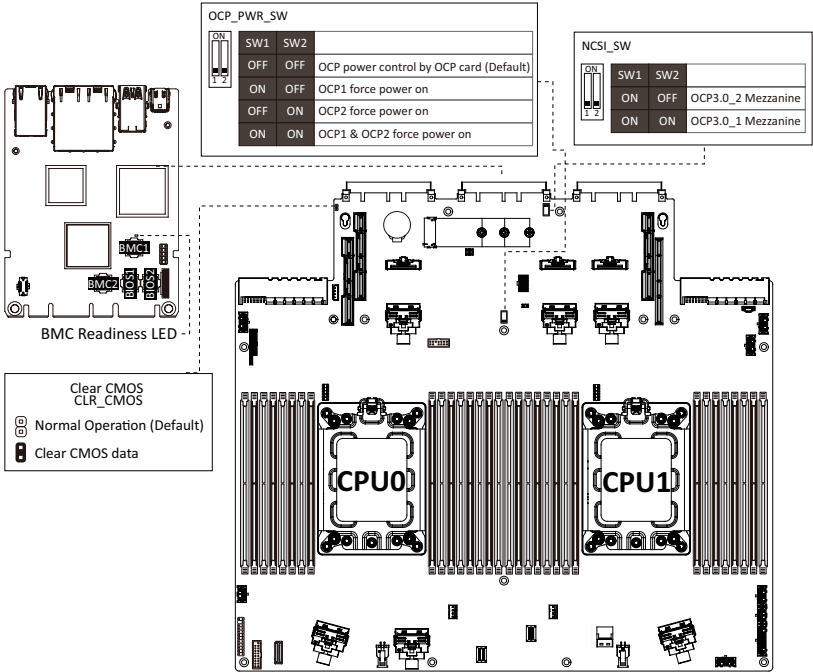

4-3 Backplane Board Storage Connector

4-3-1 System Front HDD Backplane Board (CBP2007)

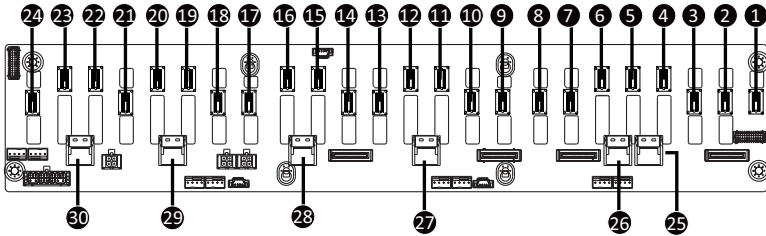

| Item | Description | Item | Description |
|------|---------------------------------|------|----------------------------------|
| 1 | SilmLine SAS Connector (U_2_0) | 16 | SilmLine SAS Connector (U_2_15) |
| 2 | SilmLine SAS Connector (U_2_1) | 17 | SilmLine SAS Connector (U_2_16) |
| 3 | SilmLine SAS Connector (U_2_2) | 18 | SilmLine SAS Connector (U_2_17) |
| 4 | SilmLine SAS Connector (U_2_3) | 19 | SilmLine SAS Connector (U_2_18) |
| 5 | SilmLine SAS Connector (U_2_4) | 20 | SilmLine SAS Connector (U_2_19) |
| 6 | SilmLine SAS Connector (U_2_5) | 21 | SilmLine SAS Connector (U_2_20) |
| 7 | SilmLine SAS Connector (U_2_6) | 22 | SilmLine SAS Connector (U_2_21) |
| 8 | SilmLine SAS Connector (U_2_7) | 23 | SilmLine SAS Connector (U_2_22) |
| 9 | SilmLine SAS Connector (U_2_8) | 24 | SilmLine SAS Connector (U_2_23) |
| 10 | SilmLine SAS Connector (U_2_9) | 25 | SilmLine SAS Connector (SL_SAS0) |
| 11 | SilmLine SAS Connector (U_2_10) | 26 | SilmLine SAS Connector (SL_SAS1) |
| 12 | SilmLine SAS Connector (U_2_11) | 27 | SilmLine SAS Connector (SL_SAS2) |
| 13 | SilmLine SAS Connector (U_2_12) | 28 | SilmLine SAS Connector (SL_SAS3) |
| 14 | SilmLine SAS Connector (U_2_13) | 29 | SilmLine SAS Connector (SL_SAS4) |
| 15 | SilmLine SAS Connector (U_2_14) | 30 | SilmLine SAS Connector (SL_SAS5) |

4-3-2 System Rear HDD Backplane Board (CBP2022)

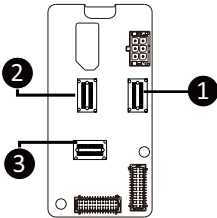

| Item | Description |
|------|----------------------------------|
| 1 | SilmLine SAS Connector (U_2_0) |
| 2 | SilmLine SAS Connector (U_2_1) |
| 3 | SilmLine SAS Connector (SL_SAS0) |

Chapter 5 BIOS Setup

BIOS (Basic Input and Output System) records hardware parameters of the system in the EFI on the motherboard. Its major functions include conducting the Power-On Self-Test (POST) during system startup, saving system parameters and loading operating system, etc. BIOS includes a BIOS Setup program that allows the user to modify basic system configuration settings or to activate certain system features. When the power is turned off, the battery on the motherboard supplies the necessary power to the CMOS to keep the configuration values in the CMOS.

To access the BIOS Setup program, press the key during the POST when the power is turned on.



- BIOS flashing is potentially risky, if you do not encounter problems of using the current BIOS version, it is recommended that you don't flash the BIOS. To flash the BIOS, do it with caution. Inadequate BIOS flashing may result in system malfunction.
- It is recommended that you not alter the default settings (unless you need to) to prevent system instability or other unexpected results. Inadequately altering the settings may result in system's failure to boot. If this occurs, try to clear the CMOS values and reset the board to default values. (Refer to the **Exit** section in this chapter or introductions of the battery/clearing CMOS jumper in Chapter 4 for how to clear the CMOS values.)

BIOS Setup Program Function Keys

| | |
|----------|--|
| <<-><->> | Move the selection bar to select the screen |
| <↑><↓> | Move the selection bar to select an item |
| <+> | Increase the numeric value or make changes |
| <-> | Decrease the numeric value or make changes |
| <Enter> | Execute command or enter the submenu |
| <Esc> | Main Menu: Exit the BIOS Setup program Submenus: Exit current submenu |
| <F1> | Show descriptions of general help |
| <F3> | Restore the previous BIOS settings for the current submenus |
| <F9> | Load the Optimized BIOS default settings for the current submenus |
| <F10> | Save all the changes and exit the BIOS Setup program |

■ **Main**

This setup page includes all the items in standard compatible BIOS.

■ **Advanced**

This setup page includes all the items of AMI BIOS special enhanced features.

(ex: Auto detect fan and temperature status, automatically configure hard disk parameters.)

■ **Chipset**

This setup page includes all the submenu options for configuring the function of processor, network, North Bridge, South Bridge, and System event logs.

■ **Server Management**

Server additional features enabled/disabled setup menus.

■ **Security**

Change, set, or disable supervisor and user password. Configuration supervisor password allows you to restrict access to the system and BIOS Setup.

A supervisor password allows you to make changes in BIOS Setup.

A user password only allows you to view the BIOS settings but not to make changes.

■ **Boot**

This setup page provides items for configuration of boot sequence.

■ **Save & Exit**

Save all the changes made in the BIOS Setup program to the CMOS and exit BIOS Setup. (Pressing <F10> can also carry out this task.)

Abandon all changes and the previous settings remain in effect. Pressing <Y> to the confirmation message will exit BIOS Setup. (Pressing <Esc> can also carry out this task.)

5-1 The Main Menu

Once you enter the BIOS Setup program, the Main Menu (as shown below) appears on the screen. Use arrow keys to move among the items and press <Enter> to accept or enter other sub-menu.

Main Menu Help

The on-screen description of a highlighted setup option is displayed on the bottom line of the Main Menu.

Submenu Help

While in a submenu, press <F1> to display a help screen (General Help) of function keys available for the menu. Press <Esc> to exit the help screen. Help for each item is in the Item Help block on the right side of the submenu.



- When the system is not stable as usual, select the **Restore Defaults** item to set your system to its defaults.
- The BIOS Setup menus described in this chapter are for reference only and may differ by BIOS version.



| Parameter | Description |
|-------------------------|---|
| Access Level | Display the privileges level information. |
| System Product Name | Displays the system product name information. |
| System Project Name | Displays the system project name information. |
| Project Name | Displays the motherboard project name information. |
| Project Version | Displays version number of the BIOS setup utility. |
| Build Date and Time | Displays the date and time when the BIOS setup utility was created. |
| BMC Information | |
| BMC Firmware Version | Displays version number of the BIOS setup utility. |
| Processor Information | |
| CPU0/1 Brand String | Displays the technical specifications for the installed processor. |
| Processor Core | |
| Max CPU Speed | |
| Memory Information | |
| Total Memory | Displays the technical specifications for the installed memory. |
| Memory Frequency | |
| Memory Slot Information | Press [Enter] to view installed memory slot information. |
| System Language | Option: English |
| System Date | Sets the date following the weekday-month-day-year format. |
| System Time | Sets the system time following the hour-minute-second format. |

5-2 Advanced Menu

The Advanced menu display submenu options for configuring the function of various hardware components. Select a submenu item, then press [Enter] to access the related submenu screen.

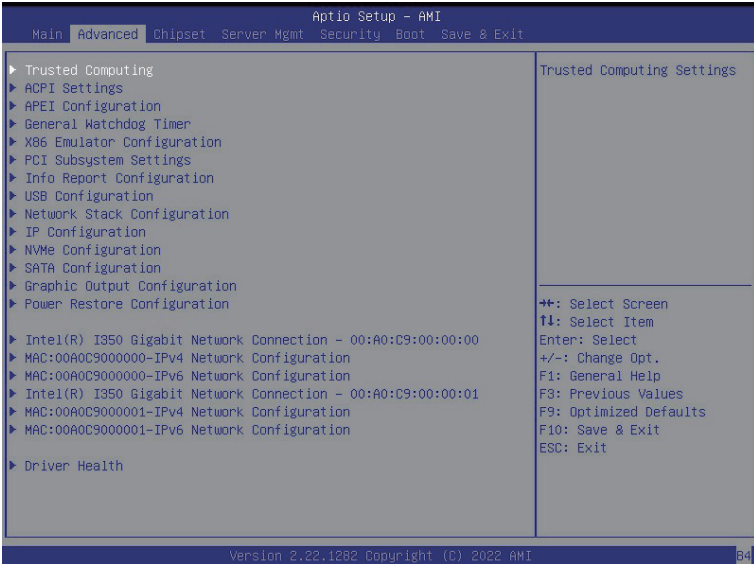

5-2-1 Trusted Computing

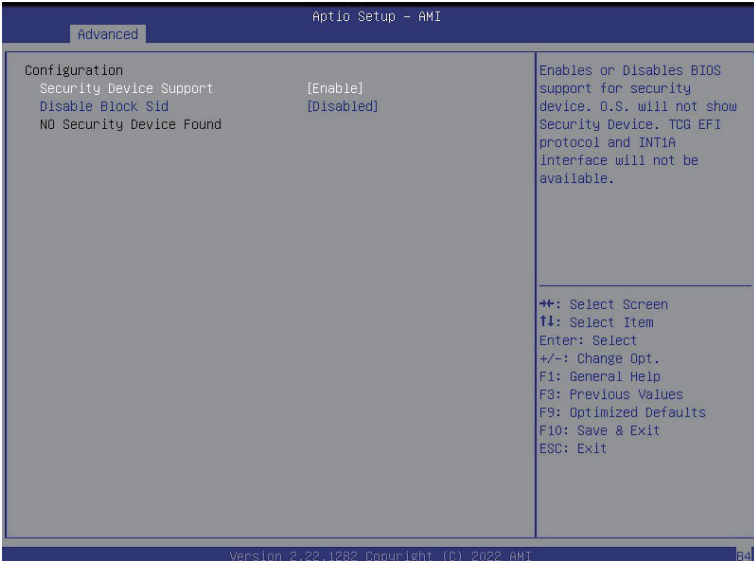

| Parameter | Description |
|-------------------------|--|
| Configuration | |
| Security Device Support | Select Enabled to activate TPM support feature. Options available: Enable/Disable. Default setting is Enable . |
| Disable Block Sid | Options available: Enabled/Disabled. Default setting is Disabled . |

5-2-2 ACPI Settings

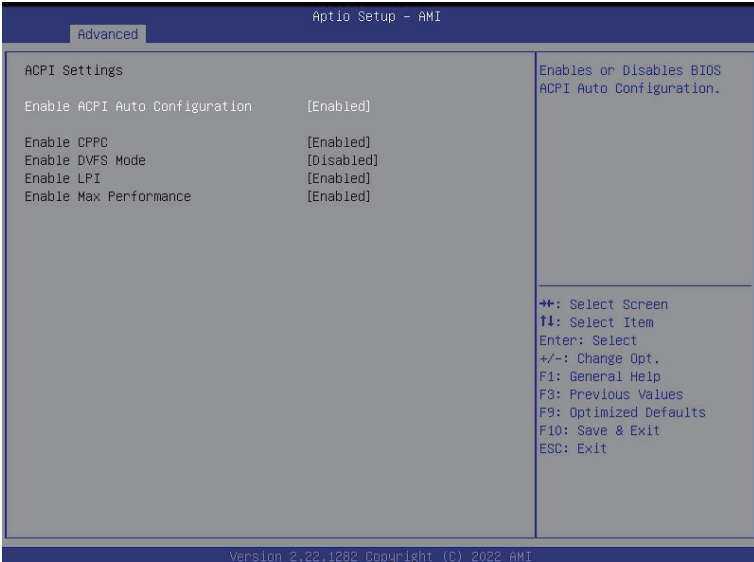

| Parameter | Description |
|--------------------------------|---|
| ACPI Settings | |
| Enable ACPI Auto Configuration | Enable or disable BIOS ACPI auto configuration. Options available: Enabled/Disabled. Default setting is Enabled . |
| Enable CPPC | Enable or disable CPPC. Options available: Enable/Disable. Default setting is Enabled . |
| Enable DVFS Mode | Options available: Enabled/Disabled. Default setting is Disabled . |
| Enable LPI | Options available: Enabled/Disabled. Default setting is Enabled . |
| Enable Max Performance | Options available: Enabled/Disabled. Default setting is Enabled . |

5-2-3 APEI Configuration



| Parameter | Description |
|--------------------|---|
| APEI Configuration | |
| APEI Enable | Enable/Disable ACPI Platform Error Interface support. Options available: Enabled/Disabled. Default setting is Disabled . |

5-2-4 General Watchdog Timer

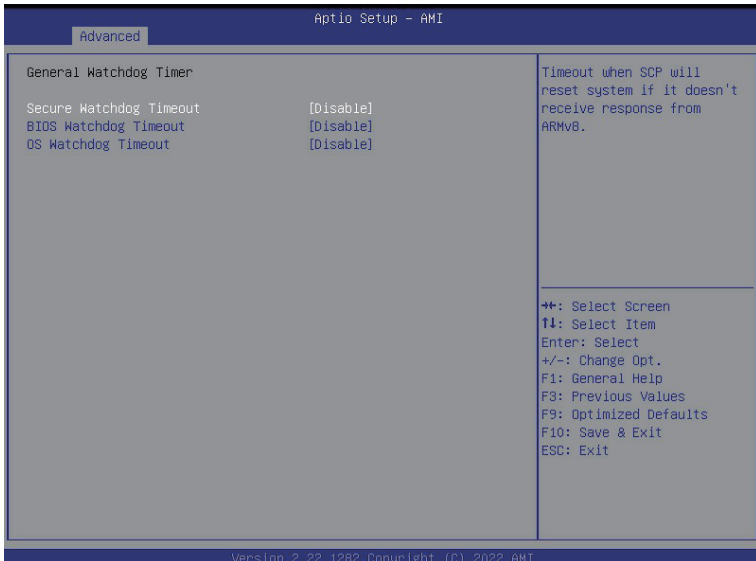

| Parameter | Description |
|-------------------------|--|
| General Watchdog Timer | |
| Secure Watchdog Timeout | Timeout when SCP will reset system if it doesn't receive response from ARMv8. Options available: 5 minutes/6 minutes/10 minutes/15 minutes/20 minutes. Default setting is Disable . |
| BIOS Watchdog Timeout | Options available: 5 minutes/6 minutes/10 minutes/15 minutes/20 minutes. Default setting is Disable . |
| OS Watchdog Timeout | Timeout when boot OS. Options available: Disable/3 minutes/4 minutes/5 minutes/6 minutes/ 10 minutes/15 minutes/20 minutes. Default setting is Disable . |

5-2-5 X86 Emulator Configuration

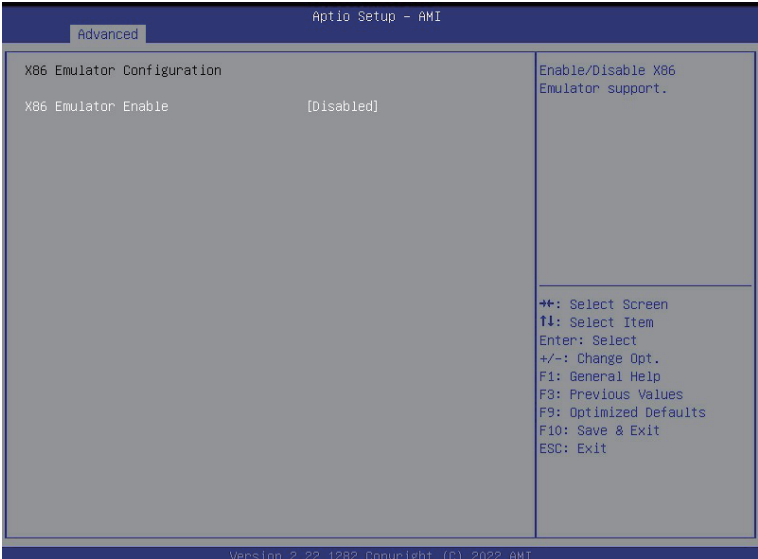

| Parameter | Description |
|----------------------------|--|
| X86 Emulator Configuraiton | |
| X86 Emulator Enable | Enable/Disable X86 Emulator support. Options available: Enabled/Disabled. Default setting is Disabled . |

5-2-6 PCI Subsystem Settings

| Aptio Setup - AMI | |
|--|---|
| Advanced | |
| <p>AMI PCI Driver Version : A5.01.20</p> <p>PCI Settings Common for all Devices: SR-IOV Support [Enabled]</p> <p>Change Settings of the Following PCI Devices:</p> <ul style="list-style-type: none"> ▶ Slot # 4 Occupied [Mass Storage Controller] ▶ Slot # 5 Occupied [Mass Storage Controller] ▶ Slot # 6 Occupied [Mass Storage Controller] ▶ Slot # 7 Occupied [Mass Storage Controller] ▶ Slot # 8 Occupied [Mass Storage Controller] ▶ Slot # 9 Occupied [Mass Storage Controller] ▶ Slot #24 Occupied [Bridge Device] ▶ Slot #25 Occupied [Mass Storage Controller] ▶ Slot #32 Occupied [Mass Storage Controller] ▶ Slot #33 Occupied [Mass Storage Controller] ▶ Slot #48 Occupied [Mass Storage Controller] ▶ Onboard Device [Bridge Device] <p>WARNING: Changing PCI Device(s) settings may have unwanted side effects! System may HANG! PROCEED WITH CAUTION.</p> | <p>If system has SR-IOV capable PCIe Devices, this option Enables or Disables Single Root IO Virtualization Support.</p> <hr/> <p> ++: Select Screen ↑↓: Select Item Enter: Select +/-: Change Opt. F1: General Help F8: Previous Values F9: Optimized Defaults F10: Save & Exit ESC: Exit </p> |
| Version 2.22.1282 Copyright (C) 2022 AMI | |

| Aptio Setup - AMI | |
|---|---|
| Advanced | |
| <p>Slot # 4 Occupied [Mass Storage Controller] Location: S:01h B:01h D:00h F:00h; VID:144D ID:A80A Supports: PCIe GEN1[X]; GEN2[X]; GEN3[X]; GEN4[X]; ARI[X]; HP []</p> <p> PCI Latency Timer [32 PCI Bus Clocks] PCI-X Latency Timer [64 PCI Bus Clocks] VGA Palette Snoop [Disabled] FERR# Generation [Disabled] SERR# Generation [Enabled] </p> <p> Disable PCIe Init [Disabled] Disable PCIe GEN 2 [Disabled] </p> <ul style="list-style-type: none"> ▶ PCI Express GEN 1 Settings ▶ PCI Express GEN 2 Settings | <p>Value to be programmed into PCI Latency Timer Register.</p> <hr/> <p> ++: Select Screen ↑↓: Select Item Enter: Select +/-: Change Opt. F1: General Help F8: Previous Values F9: Optimized Defaults F10: Save & Exit ESC: Exit </p> |
| Version 2.22.1282 Copyright (C) 2022 AMI | |

| Parameter | Description |
|--|--|
| AMI PCI Bus Driver Version | Displays the AMI PCI Bus Driver version information. |
| PCI Settings Common for all Devices: | |
| SR-IOV Support | If the system has SR-IOV capable PCIe devices, this item Enable/Disable Single Root IO Virtualization Support. Options available: Enabled/Disabled. Default setting is Enabled . |
| Change Settings of the Following PCI Devices | |
| Slot_# Occupied Onboard Device_# | <ul style="list-style-type: none"> ◆ PCI Latency Timer <ul style="list-style-type: none"> – Value to be programmed onto PCI Latency Timer Register. Options available: 32/64/96/128/160/192/224/248 PCI Bus Clocks. Default setting is 32 PCI Bus Clocks. ◆ PCI-X Latency Timer <ul style="list-style-type: none"> – Value to be programmed onto PCI Latency Timer Register. Options available: 32/64/96/128/160/192/224/248 PCI Bus Clocks. Default setting is 64 PCI Bus Clocks. ◆ VGA Palette Snoop <ul style="list-style-type: none"> – Enable or disable VGA Palette Registers Snooping. Options available: Enabled/Disabled. Default setting is Disabled. ◆ PERR# <ul style="list-style-type: none"> – Enable or disable PCI device to generate PERR. Options available: Enabled/Disabled. Default setting is Disabled. ◆ SERR# <ul style="list-style-type: none"> – Enable or disable PCI device to generate SERR. Options available: Enabled/Disabled. Default setting is Disabled. ◆ Disable PCIe Init Options available: Enabled/Disabled. Default setting is Disabled ◆ DisablePCIe GEN 2 Options available: Enabled/Disabled. Default setting is Disabled. |

5-2-6-1 PCI Express GEN 1 Settings

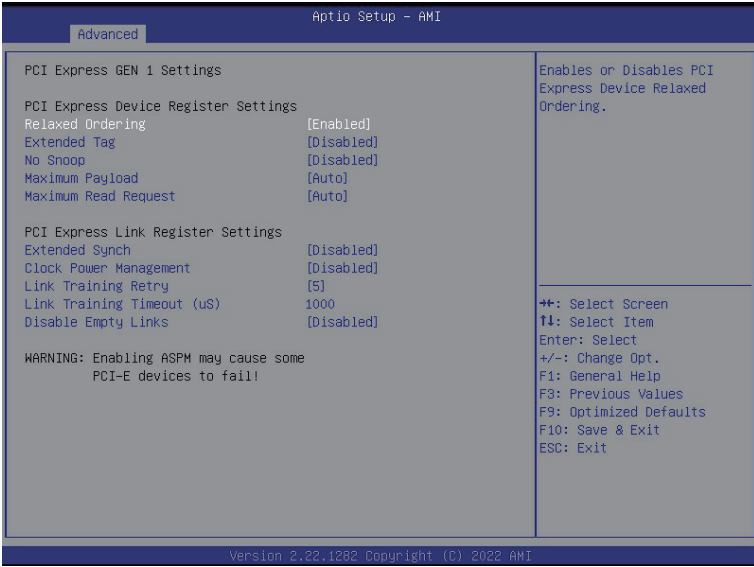

| Parameter | Description |
|--------------------------|--|
| PCI Express GEN1 Setting | <p>PCI Express GEN1 Device Register Settings</p> <ul style="list-style-type: none"> ◆ Relaxed Ordering <ul style="list-style-type: none"> – Enable or disable PCI Express Device Relaxed Ordering. Options available: Enabled/Disabled. Default setting is Enabled. ◆ Extend Tag <ul style="list-style-type: none"> – If enabled, allows device to use 8-bit Tag field as a requester. Options available: Enabled/Disabled. Default setting is Disabled. ◆ No Snoop <ul style="list-style-type: none"> – Enable or disable PCI Express Device No Snoop option. Options available: Enabled/Disabled. Default setting is Disabled. ◆ Maximum Payload <ul style="list-style-type: none"> – Set Maximum Payload of PCI Express Device or allow System BIOS to select the value. Options available: Auto/128 Bytes/ 256 Bytes. Default setting is Auto. |

| Parameter | Description |
|--------------------------|---|
| PCI Express GEN1 Setting | PCI Express Device Link Register Settings <ul style="list-style-type: none"> ◆ Maximum Read Request <ul style="list-style-type: none"> – Set Maximum Read Request of PCI Express Device or allow System BIOS to select the value. Options available: Auto/128 /256/512/1024/2048/4096 Bytes. Default setting is Auto . |
| | <ul style="list-style-type: none"> ◆ Extended Synch <ul style="list-style-type: none"> – If enabled, allows generation of Extended Synchronization patterns. Options available: Enabled/Disabled. Default setting is Disabled . |
| | <ul style="list-style-type: none"> ◆ Clock Power Management <ul style="list-style-type: none"> – If support by hardware and set to 'Enabled', the device is permitted to use CLKREQ# signal for power management of link clock in accordance to protocol defined in appropriate form factor specification. Options available: Enabled/Disabled. Default setting is Disabled . |
| | <ul style="list-style-type: none"> ◆ Link Training Retry <ul style="list-style-type: none"> – Defines numbers of Retry Attempts software will take to retrain the link if previous training attempt was unsuccessful. Options available: Disabled/2/3/5. Default setting is 5 . |
| | <ul style="list-style-type: none"> ◆ Link Training Timeout (uS) Press '+' and '-' keys to set the values. ◆ Link Training Retry <ul style="list-style-type: none"> – Defines numbers of Retry Attempts software will take to retrain the link if previous training attempt was unsuccessful. – ◆ Disable Empty Links <ul style="list-style-type: none"> – In order to save software will disable unpopulated PCI Express Device links, if this option set to 'Disabled Link'. Options available: Enabled/Disabled. Default setting is Disabled . |

5-2-6-2 PCI Express GEN 2 Settings

Advanced Aptio Setup - AMI

| | |
|--|--|
| <p>PCI Express GEN 2 Settings</p> <p>PCI Express GEN2 Device Register Settings</p> <p>Completion Timeout [Default]</p> <p>ARI Forwarding [Disabled]</p> <p>AtomicOp Requester Enable [Disabled]</p> <p>AtomicOp Egress Blocking [Disabled]</p> <p>ID0 Request Enable [Disabled]</p> <p>ID0 Completion Enable [Disabled]</p> <p>LTR Mechanism Enable [Disabled]</p> <p>End-End TLP Prefix Blocking [Disabled]</p> <p>PCI Express GEN2 Link Register Settings</p> <p>Compliance SOS [Disabled]</p> <p>Hardware Autonomous Width [Disabled]</p> <p>Hardware Autonomous Speed [Disabled]</p> | <p>In device Functions that support Completion Timeout programmability, allows system software to modify the Completion Timeout value. 'default' 50us to 50ms. If 'Shorter' is selected, software will use shorter timeout ranges supported by hardware. If 'Longer' is selected,</p> <p>←+: Select Screen ↑↓: Select Item Enter: Select +/-: Change Opt. F1: General Help F8: Previous Values F9: Optimized Defaults F10: Save & Exit ESC: Exit</p> |
|--|--|

Version 2.22.1282 Copyright (C) 2022 AMI

| Parameter | Description |
|--------------------------|---|
| | <p>PCI Express GEN2 Device Register Settings</p> <ul style="list-style-type: none"> ◆ Completion Timeout <ul style="list-style-type: none"> – In device Functions that support Completion Timeout programmability, allows system software to modify the Completion Timeout value. 'Default' 50us to 50ms. If 'Shorter' is selected, software will use shorter timeout ranges supported by hardware. If 'Longer' is selected, software will use longer timeout ranges. <p>Options available: Default/Shorter/Longer/Disabled. Default setting is Default.</p> <ul style="list-style-type: none"> ◆ ARI Forwarding <ul style="list-style-type: none"> – If supported by hardware and set to 'Enabled', the Downstream Port disables its traditional Device Number field being 0 enforcement when turning a Type1 Configuration Request into a Type0 Configuration Request, permitting access to Extended Functions in an ARI Device immediately below the Port. <p>Options available: Default/Shorter/Longer/Disabled. Default setting is Disabled.</p> |
| PCI Express GEN2 Setting | <ul style="list-style-type: none"> ◆ AtomicOp Requester Enable <ul style="list-style-type: none"> – If supported by hardware and set to 'Enabled', this function initiates AtomicOp Requests only if Bus Master Enable bit is in the Command Register Set. <p>Options available: Enabled/Disabled. Default setting is Disabled.</p> ◆ AtomicOp Egress Blocking <ul style="list-style-type: none"> – If supported by hardware and set to 'Enabled', outbound AtomicOp Requests via Egress Ports will be blocked. <p>Options available: Enabled/Disabled. Default setting is Disabled.</p> ◆ IDO Request Enable <ul style="list-style-type: none"> – If supported by hardware and set to 'Enabled', this permits setting the number of ID-Based Ordering (IDO) bit (Attribute[2]) requests to be initiated.. <p>Options available: Enabled/Disabled. Default setting is Disabled.</p> |

| Parameter | Description |
|--------------------------|---|
| PCI Express GEN2 Setting | <p data-bbox="440 150 788 170">PCI Express GEN2 Device Register Settings</p> <ul style="list-style-type: none"> <li data-bbox="440 208 929 318">◆ IDO Request Enable <ul style="list-style-type: none"> <li data-bbox="476 236 929 318">– If supported by hardware and set to 'Enabled', this permits setting the number of ID-Based Ordering (IDO) bit (Attribute[2]) requests to be initiated. <p data-bbox="440 326 948 346">Options available: Enabled/Disabled. Default setting is Disabled.</p> <ul style="list-style-type: none"> <li data-bbox="440 354 929 464">◆ IDO Completion Enable <ul style="list-style-type: none"> <li data-bbox="476 382 929 464">– If supported by hardware and set to 'Enabled', this permits setting the number of ID-Based Ordering (IDO) bit (Attribute[2]) requests to be initiated. <p data-bbox="440 471 948 492">Options available: Enabled/Disabled. Default setting is Disabled.</p> <ul style="list-style-type: none"> <li data-bbox="440 500 892 609">◆ LTR Mechanism Enable <ul style="list-style-type: none"> <li data-bbox="476 528 892 609">– If supported by hardware and set to 'Enabled', this enables the Latency Tolerance Reporting (LTR) Mechanism. <p data-bbox="440 617 948 638">Options available: Enabled/Disabled. Default setting is Disabled.</p> <ul style="list-style-type: none"> <li data-bbox="440 646 919 755">◆ End-End TLP Prefix Blocking <ul style="list-style-type: none"> <li data-bbox="476 674 919 755">– If supported by hardware and set to 'Enabled', this function will block forwarding of TLPs containing End-End TLP Prefixes. <p data-bbox="440 763 948 784">Options available: Enabled/Disabled. Default setting is Disabled.</p> |
| | <p data-bbox="440 821 756 842">PCI Express GEN2 Device Link Settings</p> <ul style="list-style-type: none"> <li data-bbox="440 879 919 1020">◆ Compliance SOS <ul style="list-style-type: none"> <li data-bbox="476 907 919 1020">– If supported by hardware and set to 'Enabled', this will force LTSSM to send SKP Ordered Sets between sequences when sending Compliance Pattern or Modified Compliance Pattern. <p data-bbox="440 1028 948 1048">Options available: Enabled/Disabled. Default setting is Disabled.</p> <ul style="list-style-type: none"> <li data-bbox="440 1056 940 1197">◆ Hardware Autonomous Width <ul style="list-style-type: none"> <li data-bbox="476 1085 940 1197">– If supported by hardware and set to 'Disabled', this will disable the hardware's ability to change link width except width size reduction for the purpose of correcting unstable link operation. <p data-bbox="440 1205 948 1226">Options available: Enabled/Disabled. Default setting is Disabled.</p> <ul style="list-style-type: none"> <li data-bbox="440 1234 945 1375">◆ Hardware Autonomous Speed <ul style="list-style-type: none"> <li data-bbox="476 1262 945 1375">– If supported by hardware and set to 'Disabled', this will disable the hardware's ability to change link speed except speed rate reduction for the purpose of correcting unstable link operation <p data-bbox="440 1382 948 1403">Options available: Enabled/Disabled. Default setting is Disabled.</p> |

5-2-7 Info Report Configuration



| Parameter | Description |
|---------------------------|--|
| Info Report Configuration | |
| Post Report | |
| Post Report | Enable/Disable Post Report support. Options available: Enabled/Disabled. Default setting is Enabled. |
| Delay Time | Options available: 0/1/2/3/4/5/6/7/8/9/10/Util Press ESC. Default setting is 1. |
| Error Message Report | |
| Info Error Message | Enable/Disable Info Error Message support. Options available: Enabled/Disabled. Default setting is Enabled . |

5-2-8 USB Configuration

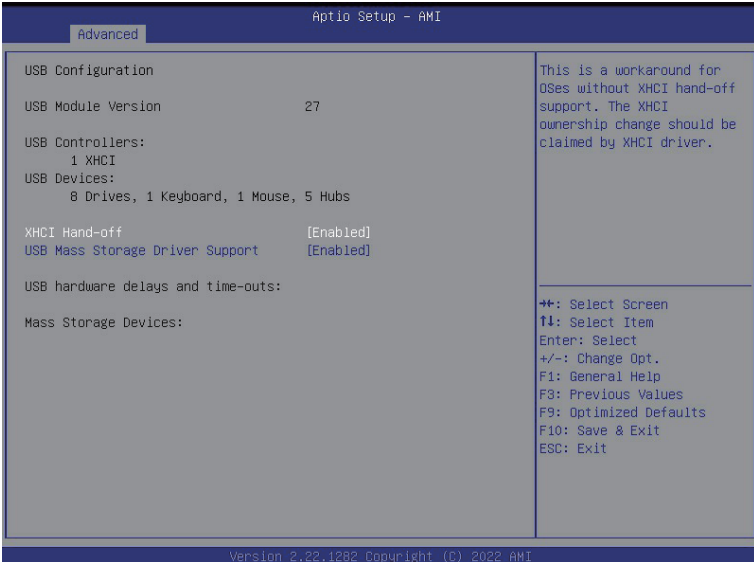

| Parameter | Description |
|---|---|
| USB Configuration | |
| USB Module Version | Displays USB module version information. |
| USB Controller | Displays the supported USB controllers. |
| USB Devices: | Displays the USB devices connected to the system. |
| XHCI Hand-off | Enable/Disable the XHCI (USB 3.0) Hand-off support. Options available: Enabled/Disabled. Default setting is Enabled . |
| USB Mass Storage Driver Support ^(Note) | Enable/Disable the USB Mass Storage Driver Support. Options available: Enabled/Disabled. Default setting is Enabled . |

(Note) This item is present only if you attach USB devices.

5-2-9 Network Stack Configuration

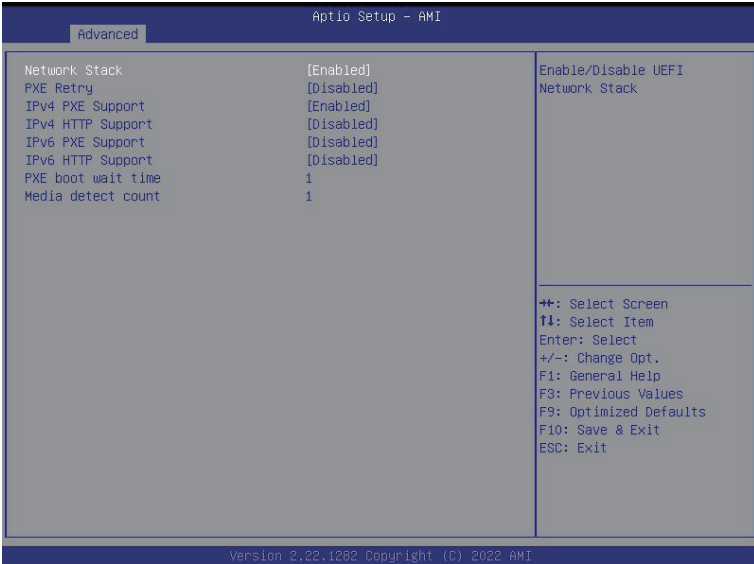

| Parameter | Description |
|--------------------|--|
| Network Stack | Enable/Disable the UEFI network stack. Options available: Enabled/Disabled. Default setting is Enabled . |
| PXE Retry | Options available: Enabled/Disabled. Default setting is Disabled . |
| Ipv4 PXE Support | Enable/Disable the Ipv4 PXE feature. Options available: Enabled/Disabled. Default setting is Enabled . |
| Ipv4 HTTP Support | Enable/Disable the Ipv4 HTTP feature. Options available: Enabled/Disabled. Default setting is Disabled . |
| Ipv6 PXE Support | Enable/Disable the Ipv6 PXE feature. Options available: Enabled/Disabled. Default setting is Disabled . |
| Ipv6 HTTP Support | Enable/Disable the Ipv6 HTTP feature. Options available: Enabled/Disabled. Default setting is Disabled . |
| PXE boot wait time | Press the <+> / <-> keys to increase or decrease the desired values. |
| Media detect count | Press the <+> / <-> keys to increase or decrease the desired values. |

5-2-10 IP Configuration



| Parameter | Description |
|---|--|
| IP Configuration Settings | |
| Provide the Options to Configure the IP Address | |
| Auto Configuration | Options available: Disabled/Every Boot/On Demand. Default setting is Disabled . |

5-2-11 NVMe Configuration

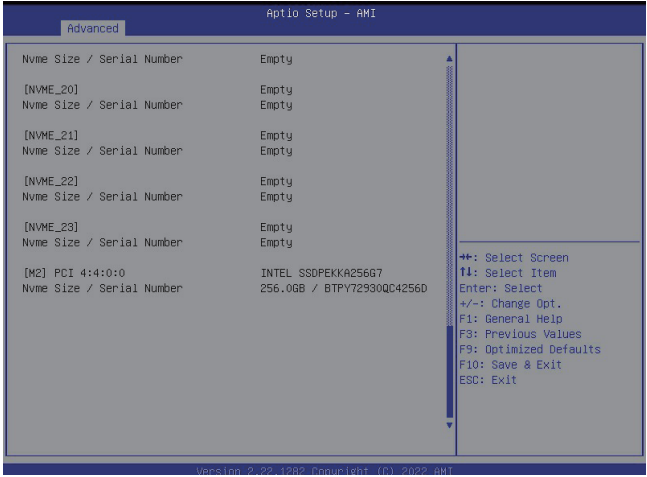
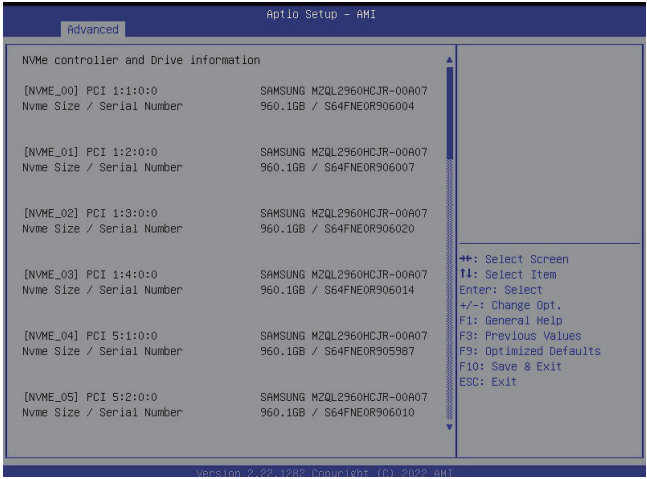

| Parameter | Description |
|---------------------------------------|--|
| NVMe controller and Drive Information | Displays the NVMe devices connected to the system. |
| Auto Configuration | Allows user to set IP. Options available: Every Boot/On Demand/Disabled. Default setting is Disabled . |

5-2-12 SATA Configuration

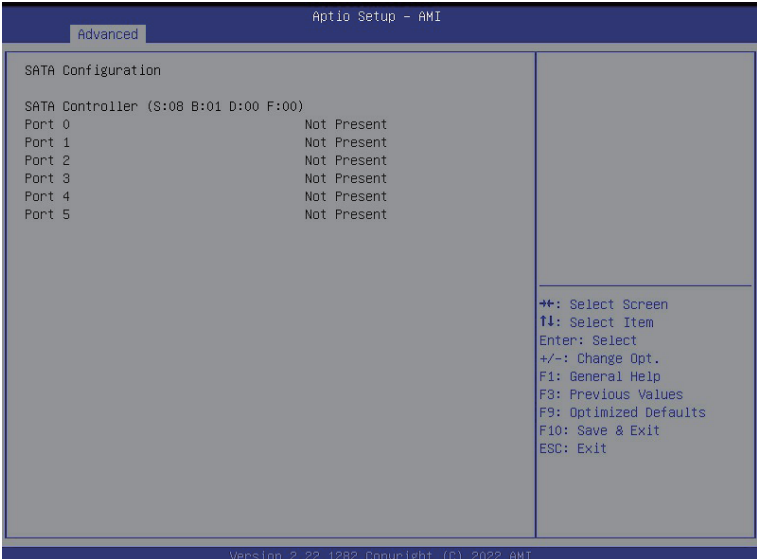

| Parameter | Description |
|-----------------------------|--|
| SATA Configuration | |
| SATA Controllers: Port_# | Displays the installed HDD devices information. System will automatically detect HDD type. |

5-2-13 Graphic Output Configuration



| Parameter | Description |
|--------------------|--|
| UEFI Configuration | |
| Output Device Type | Select output device. Options available: First loaded Device, Onboard Device, External Device, Specific Device. Default setting is Onboard Device . |
| OS graphics output | Options available: Controlled by OS/Onboard VGA. Default setting is Controlled by OS . |

5-2-14 Power Restore Configuration

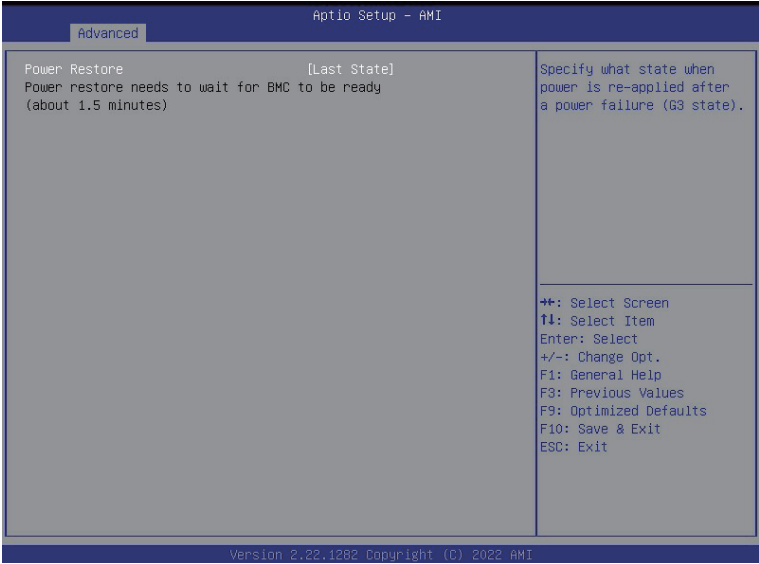

| Parameter | Description |
|---------------|--|
| Power Restore | Specify what state when power is re-applied after a power failure (G3 state). Options available: Last State/Power On/Power Off. Default setting is Last State . |

5-2-15 Intel(R) I350 Gigabit Network Connection

Aptio Setup - AMI

Advanced

| | | |
|---|--|---|
| <p>▶ NIC Configuration</p> <p>Blink LEDs 15</p> <p>UEFI Driver Intel(R) PRO/1000 Open Source 9.2.06 PCI-E</p> <p>Adapter PBA 106300-000</p> <p>Device Name Intel(R) I350 Gigabit Network Connection</p> <p>Chip Type Intel i350</p> <p>PCI Device ID 1521</p> <p>PCI Address 05:00:00</p> <p>Link Status [Disconnected]</p> <p>MAC Address 00:A0:C9:00:00:00</p> <p>Virtual MAC Address Intel(R) I350 Gig</p> | | <p>Click to configure the network device port.</p> |
| | | <p>→: Select Screen ↑↓: Select Item Enter: Select +/-: Change Opt. F1: General Help F8: Previous Values F9: Optimized Defaults F10: Save & Exit ESC: Exit</p> |

Version 2.22.12B2 Copyright (C) 2022 AMI

Aptio Setup - AMI

Advanced

| | | |
|--|--|---|
| <p>Link Speed [Auto Negotiated]</p> <p>Wake On LAN [Enabled]</p> | | <p>Specifies the port speed used for the selected boot protocol.</p> |
| | | <p>→: Select Screen ↑↓: Select Item Enter: Select +/-: Change Opt. F1: General Help F8: Previous Values F9: Optimized Defaults F10: Save & Exit ESC: Exit</p> |

Version 2.22.12B2 Copyright (C) 2022 AMI

| Parameter | Description |
|---------------------|--|
| NIC Configuration | <p>Press [Enter] to configure advanced items.</p> <ul style="list-style-type: none"> ◆ Link Speed <ul style="list-style-type: none"> – Allows for automatic link speed adjustment. – Options available: Auto Negotiated/10 Mbps Half/10 Mbps Full/100 Mbps Half/100 Mbps Full. Default setting is Auto Negotiated. ◆ Wake On LAN <ul style="list-style-type: none"> – Enables power on of the system via LAN. Note that configuring Wake on LAN in the operating system does not change the value of this setting, but does override the behavior of Wake on LAN in OS controlled power states. – Options available: Enabled/Disabled. Default setting is Enabled. |
| Blink LEDs | <p>Identifies the physical network port by blinking the associated LED. Press the numeric keys to adjust desired values.</p> |
| UEFI Driver | Displays the technical specifications for the Network Interface Controller. |
| Adapter PBA | Displays the technical specifications for the Network Interface Controller. |
| Device Name | Displays the technical specifications for the Network Interface Controller. |
| Chip Type | Displays the technical specifications for the Network Interface Controller. |
| PCI Device ID | Displays the technical specifications for the Network Interface Controller. |
| PCI Address | Displays the technical specifications for the Network Interface Controller. |
| Link Status | Displays the technical specifications for the Network Interface Controller. |
| MAC Address | Displays the technical specifications for the Network Interface Controller. |
| Virtual MAC Address | Displays the technical specifications for the Network Interface Controller. |

5-2-16 MAC IPv4 Network Configuration

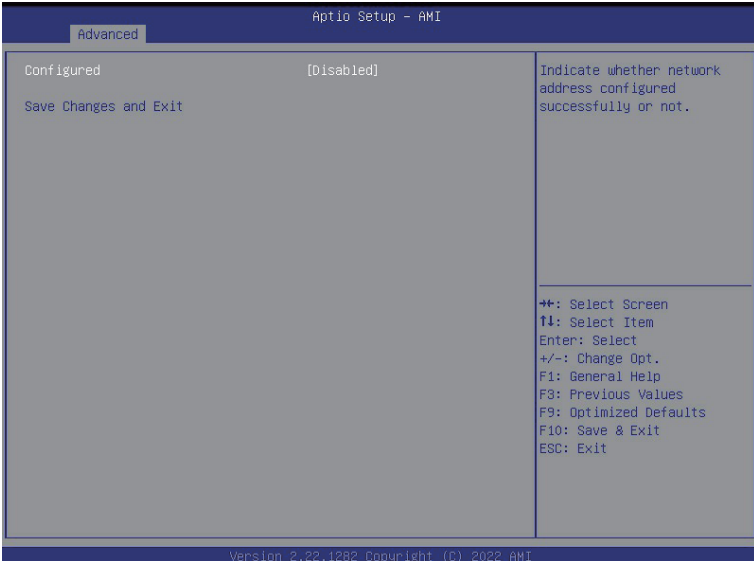

| Parameter | Description |
|------------------------------|---|
| Configured ^(Note) | Options available: Enabled/Disabled. Default setting is Disabled . |
| Enable DHCP | Options available: Enabled/Disabled. Default setting is Enabled . |
| Local IP Address | Press [Enter] to configure local IP address. |
| Local NetMask | Press [Enter] to configure local NetMask. |
| Local Gateway | Press [Enter] to configure local Gateway |
| Local DNS Servers | Press [Enter] to configure local DNS servers |
| Save Changes and Exit | Press [Enter] save all configurations. |

(Note) Advance items prompt when this item set to **Enabled**.

5-2-17 MAC IPv6 Network Configuration



| Parameter | Description |
|--------------------------|--|
| Enter Configuration Menu | Press [Enter] for configuration of advanced items. |

5-2-18 Driver Health

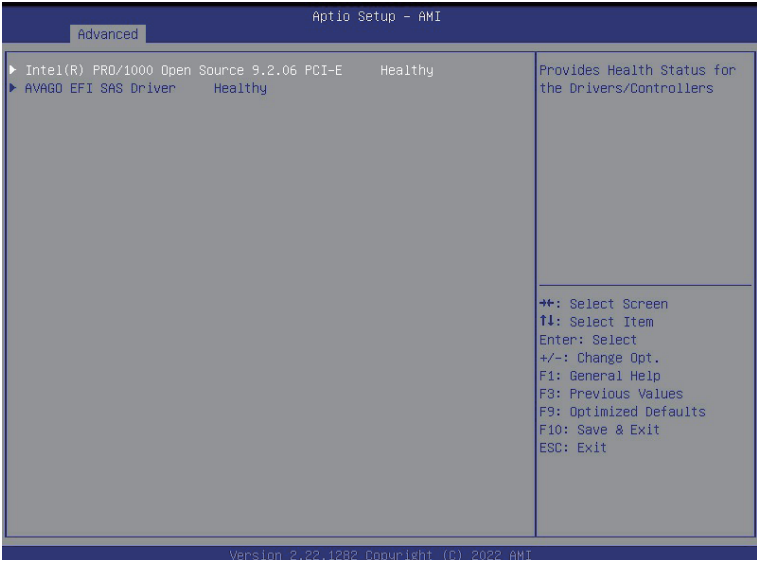

| Parameter | Description |
|---------------|---|
| Driver Health | Displays driver health status of the devices/controllers if installed |

5-3 Chipset Setup Menu

Chipset Setup menu displays submenu options for configuring the function of the North Bridge. Select a submenu item, then press [Enter] to access the related submenu screen.



| Parameter | Description |
|---------------------------------|--|
| CPU Configuration | Press [Enter] for configuration of advanced items. |
| RAS Configuration | Press [Enter] for configuration of advanced items. |
| Memory Slot Configuration | Press [Enter] for configuration of advanced items. |
| Serialport Console | Press [Enter] for configuration of advanced items. |
| PCIE Root Complex Configuration | Press [Enter] for configuration of advanced items. |

5-3-1 CPU Configuration

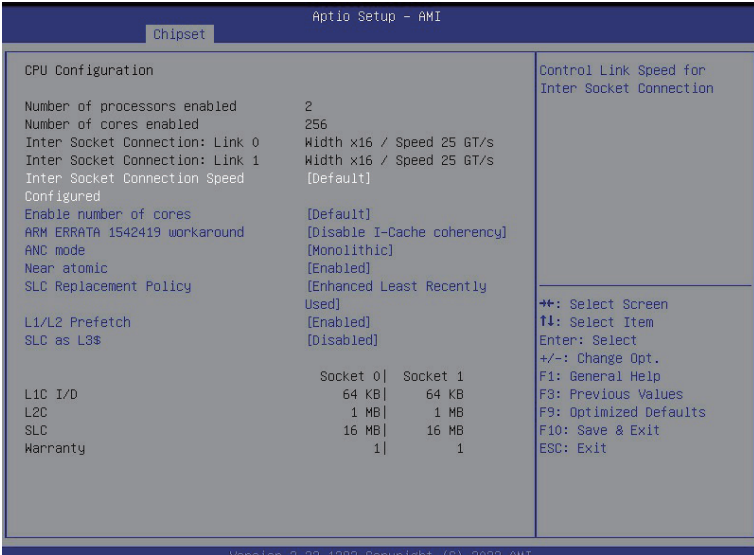

| Parameter | Description |
|--|---|
| CPU Configuration | |
| Numbers of processor enabled | Displays the number of installed processor information. |
| Numbers of core enabled | Displays the core of installed processor information. |
| Inter Socket Connection 0/1 | Displays the inter socket 0/1 connection information. |
| Inter Socket Connection Speed Configured | Control Link Speed for Inter Socket Connection. Option: Default/16 GT/s/20 GT/s/25 GT/s. Default Setting is Default . |
| Enable number of cores | Option: Default/2/4/6/8/10/12/14/16/18/20/22/24/26/28/30/32/34/36....256. Default Setting is Default . |
| ARM ERRATA 1542419 workaround | Option available: Disable I-Cache coherency/Software solution/Disable. Default Setting is Disable I-Cache coherency . |
| ANC mode | Option available: Monolithic/Hemisphere/Quadrant. Default Setting is Monolithic . |
| Near atomic | Enable/disable cacheable atomic instruction executed near in CPU. Option available: Enabled/Disabled. Default Setting is Enabled . |

| | |
|-----------------------------------|--|
| SLC Replacement Policy | Option available: Enhanced Least Recently Used/Linear-Feedback Shift Register. Default Setting is Enhanced Least Recently Used . |
| L1C I/D L2C SLC Warranty | Displays the technical specifications for the installed processor. |

5-3-2 RAS Configuration

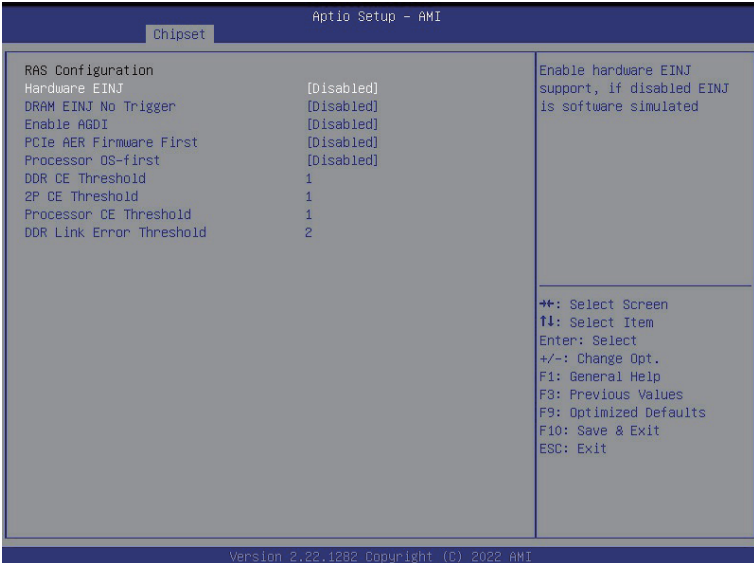

| Parameter | Description |
|--------------------------|---|
| RAS Configuration | |
| Hardware EIJN | Option available: Enabled/Disabled. Default setting: Disabled . |
| DRAM EIJN No Trigger | Option available: Enabled/Disabled. Default setting: Disabled . |
| Enable AGDI | Option available: Enabled/Disabled. Default setting: Disabled . |
| PCIe AER Firmware First | Option available: Enabled/Disabled. Default setting: Disabled . |
| Processor OS-first | Option available: Enabled/Disabled. Default setting: Disabled . |
| DDR CE Threshold | Press '+' or '-' to configure the threshold. |
| 2P CE Threshold | Press '+' or '-' to configure the threshold. |
| Processor CE Threshold | Press '+' or '-' to configure the threshold. |
| DDR Kink Error Threshold | Press '+' or '-' to configure the threshold. |

5-3-3 Memory Slot Information

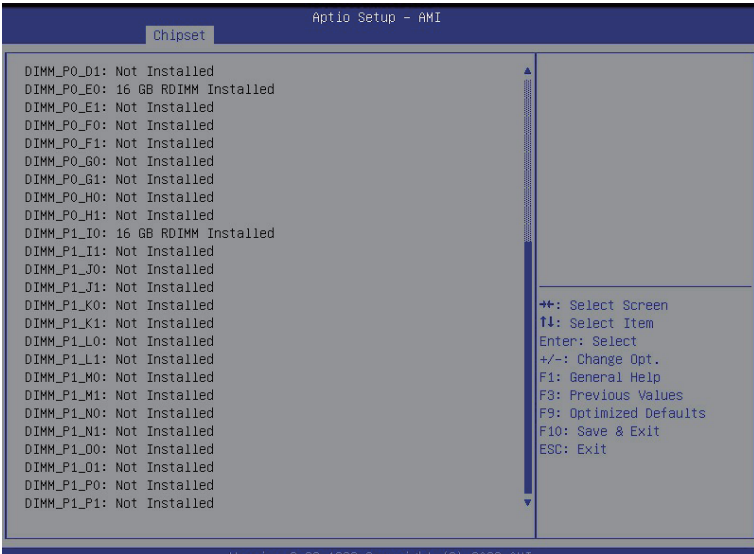
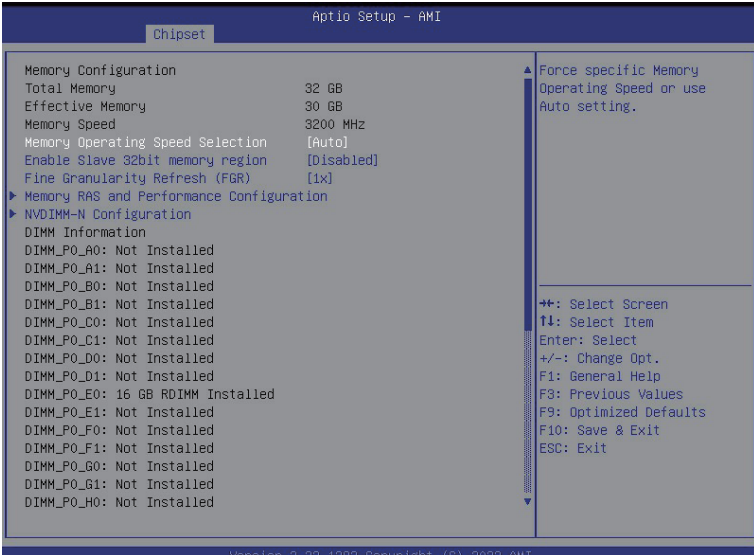

| Parameter | Description |
|--|---|
| Memory Configuration | |
| Total Memory | |
| Effective Memory | Displays the technical specifications for the installed DIMM. |
| Memory Speed | |
| Memory Operating Speed Selection | Option available: Auto/2133/2400/2666/2933/3200. Default setting: Auto . |
| Enable Slave 32bit memory region | Option available: Enabled/Disabled. Default setting: Disabled . |
| Fine Granularity Refresh (FGR) | Select DDR Fine Granularity Refresh (FGR) mode. Option available: 1x/2x/4x. Default setting is 1x . |
| Memory RAS and Performance Configuration | Press [Enter] for advanced configuration. |
| NVDIMM -N Configuration | Press [Enter] for advanced configuration. |
| DIMM Information | Display installed DIMM information. |

5-3-3-1 Memory RAS and Performance Configuration

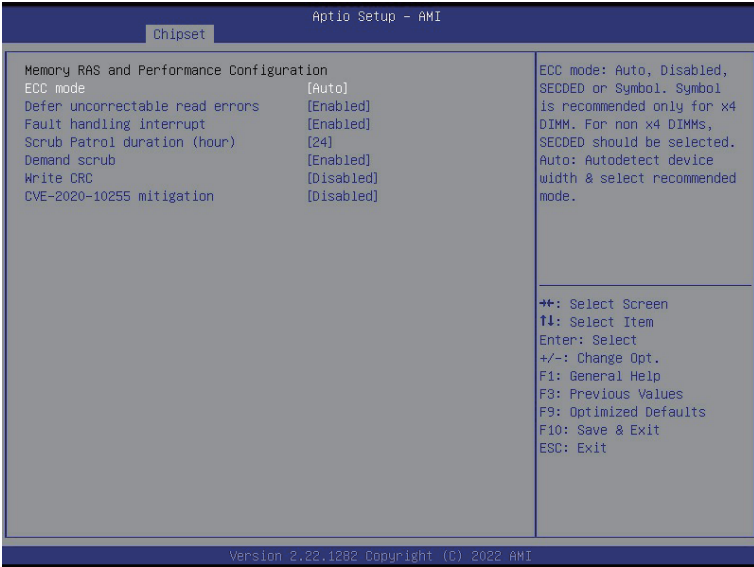

| Parameter | Description |
|--|---|
| Memory RAS and Performance Configuration | |
| ECC Mode | Option available: Disabled/SECCDED/Symbol Default setting: SECCDED. |
| Defer uncorrectable read errors | Option available: Enabled/Disabled. Default setting: Disabled . |
| Fault handling interrupt | Option available: Enabled/Disabled. Default setting: Enabled . |
| Scrub Patrol duration (hour) | Option available: 1...24. Default setting: 24 . |
| Demand scrub | Option available: Enabled/Disabled. Default setting: Enabled . |
| Write CRC | Option available: Enabled/Disabled. Default setting: Disabled . |
| CVE=2020-10255 mitigation | Option available: Enabled/Disabled. Default setting: Disabled . |

5-3-3-2 NVDIMM-N Configuration

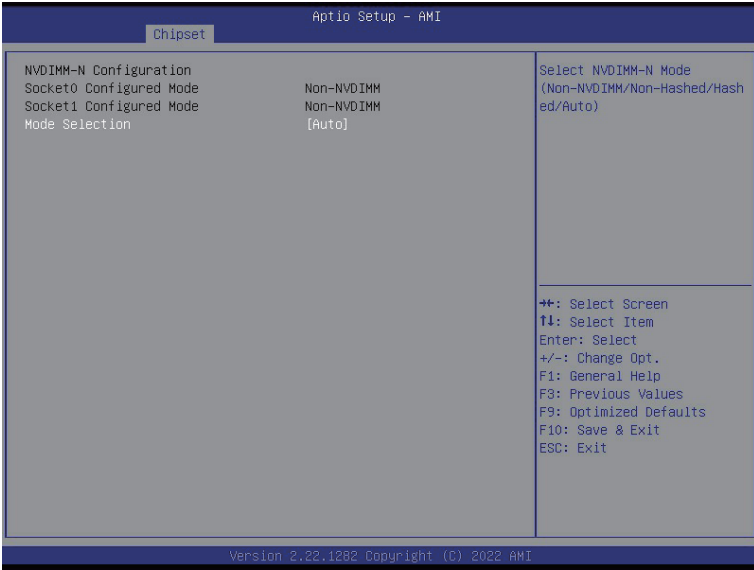

| Parameter | Description |
|-------------------------|---|
| NVDIMM-N Configuration | |
| Socket0/1 Configuration | |
| Mode Selection | Select NVDIMM-N Mode. Option available: Non-NVDIMM/Non-Hashed/Hashed/Auto. Default setting: Auto . |

5-3-4 Serialport Console



| Parameter | Description |
|-----------------------------|---|
| Serialport console | |
| Serialport console or UART0 | To enable or disable the Console Redirection for UART0. Option available: Enabled/Disabled. Default setting: Enabled . |
| Serialport console or UART2 | To enable or disable the Console Redirection for UART2. Option available: Enabled/Disabled. Default setting: Enabled . |

5-3-5 PCIe Root Complex Configuration

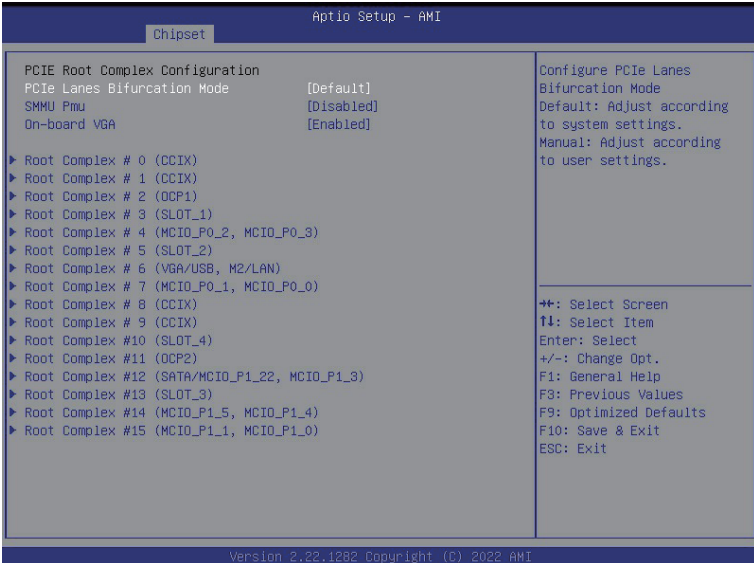

| Parameter | Description |
|----------------------------------|---|
| PCIe Root Complex Configuration | |
| PCIe Lanes Bifurcation | Option available: Manual/Default. Default setting: Default . |
| SMMU Pmu | Enable/Disable PMU feature for SMMU. Option available: Enabled/Disabled. Default setting: Disabled . |
| On-board VGA | Enable/Disable on-board VGA. Option available: Enabled/Disabled. Default setting: Enabled . |
| Root Complex_# ^(Note) | Press [Enter] to view advanced items. |

(Note) Advance items can be configurable when PCIe Lanes Bifurcation is set to **Manual**.

5-4 Server Management Menu

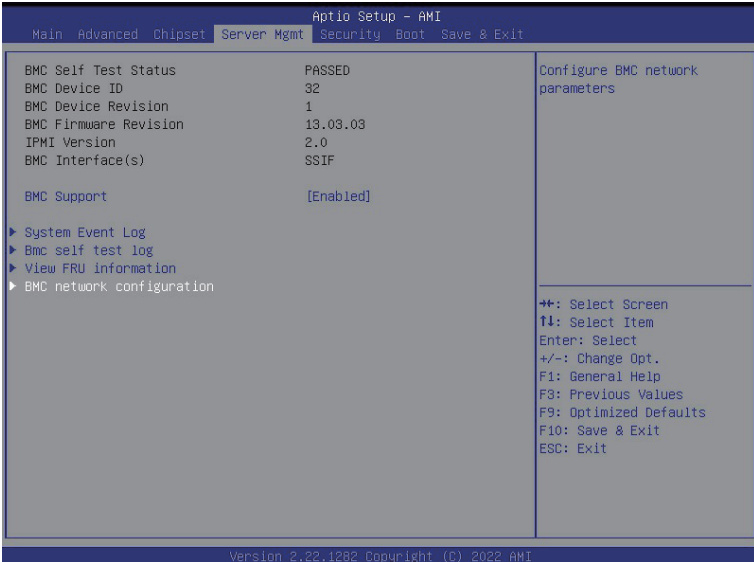

| Parameter | Description |
|---------------------------|--|
| BMC Support | Enable/Disable interfaces to communicate with BMC. Options available: Enabled/Disabled. Default setting is Enabled . |
| System Event Log | Press [Enter] to configure advanced items. |
| BMC self test | Press [Enter] to configure advanced items. |
| View FRU Information | Press [Enter] to view the advanced items. |
| BMC network configuration | Press [Enter] to configure advanced items. |

5-4-1 System Event Log



| Parameter | Description |
|------------------------------|---|
| Enabling / Disabling Options | |
| SEL Components | Change this item to enable or disable all features of System Event Logging during boot. Options available: Enabled/Disabled. Default setting is Enabled . |
| Erasing Settings | |
| Erasing SEL | Choose options for erasing SEL. Options available: No/Yes, On next reset/Yes, On every reset. Default setting is No . |
| When SEL is Full | Choose options for reactions to a full SEL. Options available: Do Nothing/Erase Immediately/Delete Oldest Record. Default setting is Do Nothing . |
| Custom EFI Logging Options | |
| Log EFI Status Codes | Enable/Disable the logging of EFI Status Codes (if not already converted to legacy). Options available: Disabled/Both/Error code/Progress code. Default setting is Error code . |

5-4-2 BMC self test



| Parameter | Description |
|-----------------------------------|---|
| log area usage =00 out of 20 logs | |
| Erase Log | Options available: No/Yes, On next reset/Yes, On every reset. Default setting is No . |
| When Log is full | Configuration for reactions to a full log. Option available: Do not log any more/Clear Log. Default setting is Do not log any more . |

5-4-3 View FRU Information

The FRU page is a simple display page for basic system ID information, as well as System product information. Items on this window are non-configurable.



(Note) The model name will vary depends on the product you purchased.

5-4-4 BMC Network Configuration

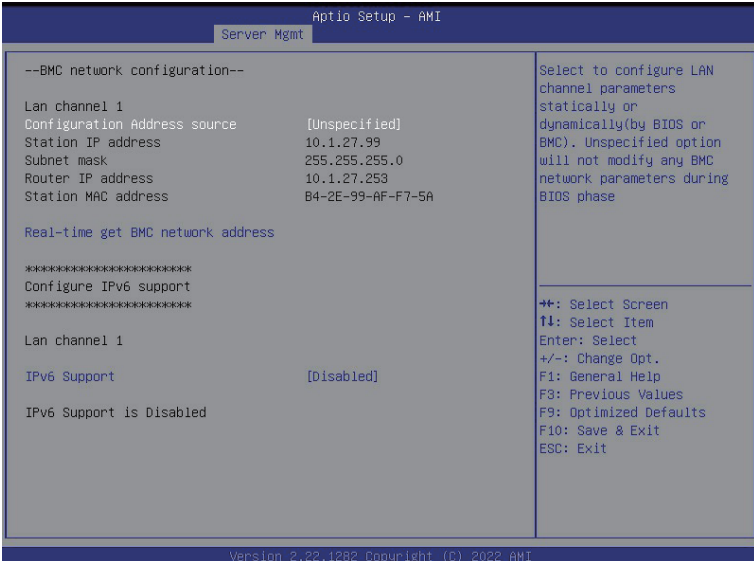

| Parameter | Description |
|-----------------------------------|--|
| BMC network configuration | |
| Lan Channel 1 | |
| Configuration Address source | Select to configure LAN channel parameters statically or dynamically (DHCP). Do nothing option will not modify any BMC network parameters during BIOS phase. Options available: Unspecified/Static/DynamicBmcDhcp. Default setting is DynamicBmcDhcp . |
| Station IP address | Displays IP Address information. |
| Subnet mask | Displays Subnet Mask information. Please note that the IP address must be in three digitals, for example, 192.168.000.001. |
| Router IP address | Displays the Router IP Address information. |
| Station MAC address | Displays the MAC Address information. |
| Real-time get BMC network address | Press [Enter] to synchronize the BMC network address |
| IPv6 Support ^(Note) | Option available: Enabled/Disabled. Default Setting is Disabled . |

(Note) Advance items can be configurable when IPv6 Support is set to **Enabled**.

5-5 Security Menu

The Security menu allows you to safeguard and protect the system from unauthorized use by setting up access passwords.

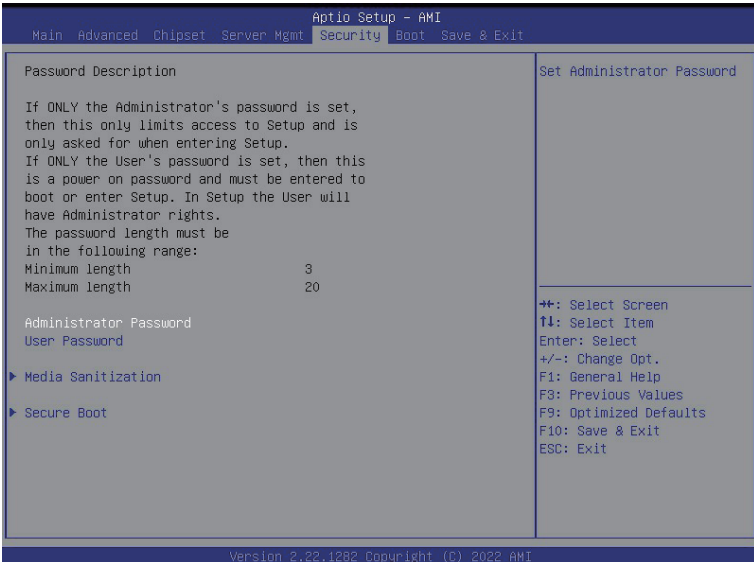

There are two types of passwords that you can set:

- Administrator Password
Entering this password will allow the user to access and change all settings in the Setup Utility.
- User Password
Entering this password will restrict a user's access to the Setup menus. To enable or disable this field, a Administrator Password must first be set. A user can only access and modify the System Time, System Date, and Set User Password fields.

| Parameter | Description |
|------------------------|--|
| Administrator Password | Press [Enter] to configure the administrator password. |
| User Password | Press [Enter] to configure the user password. |
| Media Sanitization | Press [Enter] to configure advanced items. |
| Secure Boot | Press [Enter] to configure advanced items. |

5-5-1 Media Sanitization

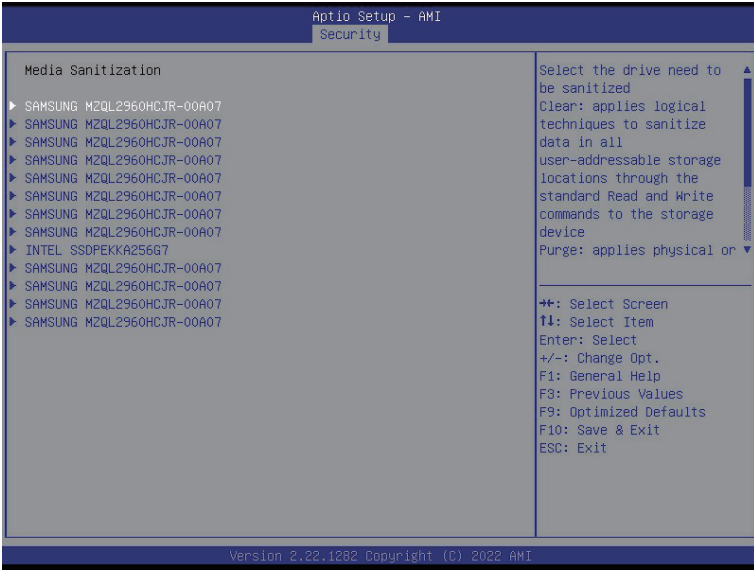

| Parameter | Description |
|----------------------------------|---|
| Media Sanitization Configuration | |
| Device Name | Display device name. |
| Method Type | Select which method apply for this drive. Options available: Clear/Purge. Default settings: Clear. |
| Start This Device Sanitization | Start sanitizing this device with setup configuraiton. |

5-5-2 Secure Boot



| Parameter | Description |
|------------------------------------|---|
| System Mode | Displays the system is in User mode or Setup mode. |
| Secure Boot Mode ^(Note) | Secure Boot requires all the applications that are running during the booting process to be pre-signed with valid digital certificates. This way, the system knows all the files being loaded before Windows loads and gets to the login screen have not been tampered with. When set to Standard, it will automatically load the Secure Boot keys from the BIOS databases. When set to Custom, you can customize the Secure Boot settings and manually load its keys from the BIOS database. Options available: Standard/Custom. Default setting is Custom. |
| Restore Factory Keys | Press [Enter] to force system to User mode. Install factory default Secure Boot key databases. |
| Reset To Setup Mode | Press [Enter] to delete all Secure Boot key databases from NVRAM. |

(Note) Advanced items prompt when this item is set to **Custom**.

| Parameter | Description |
|----------------|---|
| Key Management | <p data-bbox="333 137 668 161">Press [Enter] to configure advanced items.</p> <p data-bbox="333 166 939 216">Please note that this item is configurable when Secure Boot Mode is set to Custom.</p> <ul style="list-style-type: none"> <li data-bbox="333 221 950 330">◆ Provision Factory Defaults <ul style="list-style-type: none"> <li data-bbox="370 244 950 299">– Allows to provision factory default Secure Boot keys when system is in Setup Mode. <li data-bbox="370 304 902 330">– Options available: Enabled/Disabled. Default setting is Disabled. <li data-bbox="333 335 950 413">◆ Install Factory Default Keys <ul style="list-style-type: none"> <li data-bbox="370 359 928 385">– Installs all factory default keys. It will force the system in User Mode. <li data-bbox="370 390 602 413">– Options available: Yes/No. <li data-bbox="333 418 950 497">◆ Enroll Efi Image <ul style="list-style-type: none"> <li data-bbox="370 442 902 497">– Press [Enter] to enroll SHA256 hash of the binary into Authorized Signature Database (db). <li data-bbox="333 501 950 556">◆ Save all Secure Boot variables <ul style="list-style-type: none"> <li data-bbox="370 525 877 556">– Press [Enter] to save all Secure Boot Keys and Key variables. <li data-bbox="333 561 950 616">◆ Secure Boot variable <ul style="list-style-type: none"> <li data-bbox="370 584 896 616">– Displays the current status of the variables used for secure boot. <li data-bbox="333 620 950 730">◆ Platform Key (PK) <ul style="list-style-type: none"> <li data-bbox="370 644 804 671">– Displays the current status of the Platform Key (PK). <li data-bbox="370 675 678 702">– Press [Enter] to configure a new PK. <li data-bbox="370 707 612 730">– Options available: Set New. <li data-bbox="333 735 950 868">◆ Key Exchange Keys (KEK) <ul style="list-style-type: none"> <li data-bbox="370 758 944 785">– Displays the current status of the Key Exchange Key Database (KEK). <li data-bbox="370 790 907 845">– Press [Enter] to configure a new KEK or load additional KEK from storage devices. <li data-bbox="370 849 678 868">– Options available: Set New/Append. <li data-bbox="333 873 950 1006">◆ Authorized Signatures (DB) <ul style="list-style-type: none"> <li data-bbox="370 896 907 923">– Displays the current status of the Authorized Signature Database. <li data-bbox="370 928 950 983">– Press [Enter] to configure a new DB or load additional DB from storage devices. <li data-bbox="370 987 678 1006">– Options available: Set New/Append. <li data-bbox="333 1011 950 1144">◆ Forbidden Signatures (DBX) <ul style="list-style-type: none"> <li data-bbox="370 1034 902 1061">– Displays the current status of the Forbidden Signature Database. <li data-bbox="370 1066 896 1121">– Press [Enter] to configure a new dbx or load additional dbx from storage devices. <li data-bbox="370 1125 678 1144">– Options available: Set New/Append. <li data-bbox="333 1149 950 1282">◆ Authorized TimeStamps (DBT) <ul style="list-style-type: none"> <li data-bbox="370 1172 928 1199">– Displays the current status of the Authorized TimeStamps Database. <li data-bbox="370 1204 907 1259">– Press [Enter] to configure a new DBT or load additional DBT from storage devices. <li data-bbox="370 1263 678 1282">– Options available: Set New/Append. <li data-bbox="333 1287 950 1420">◆ OsRecovery Signatures <ul style="list-style-type: none"> <li data-bbox="370 1310 918 1337">– Displays the current status of the OsRecovery Signature Database. <li data-bbox="370 1342 891 1397">– Press [Enter] to configure a new OsRecovery Signature or load additional OsRecovery Signature from storage devices. <li data-bbox="370 1401 678 1420">– Options available: Set New/Append. |

5-6 Boot Menu

The Boot menu allows you to set the drive priority during system boot-up. BIOS setup will display an error message if the legacy drive(s) specified is not bootable.

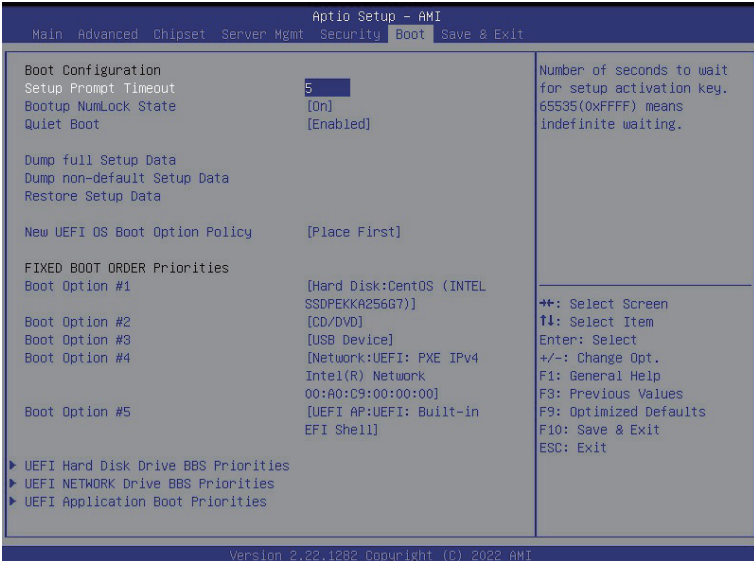

| Parameter | Description |
|----------------------|---|
| Boot Configuration | |
| Setup Prompt Timeout | Number of seconds to wait for setup activation key. 65535 (0xFFFF) means indefinite waiting. Press the numeric keys to input the desired values. |
| Bootup NumLock State | Enable/Disable the Bootup NumLock function. Options available: On/Off. Default setting is On . |
| Quiet Boot | Enable/Disable showing the logo during POST. Options available: Enabled/Disabled. Default setting is Enabled . |

| Parameter | Description |
|------------------------------------|--|
| Dump full Setup Data | |
| Dump non-default Setup Data | |
| Restore Setup Date | |
| New UEFI OS Boot Option Policy | Option available: Default/Place First/Place Last. Default setting is Place First . |
| FIXED BOOT ORDER | |
| Priorities | |
| Boot Option #1 / #2 / #3 / #4 / #5 | Press [Enter] to configure the boot priority. By default, the server searches for boot devices in the following sequence: <ol style="list-style-type: none"> 1. Hard drive. 2. CD-COM/DVD drive. 3. USB device. 4. Network. 5. UEFI. |
| UEFI Network Drive BBS Priorities | Press [Enter] to configure the boot priority. |
| UEFI Application Boot Priorities | Press [Enter] to configure the boot priority. |

5-7 Save & Exit Menu

The Exit menu displays the various options to quit from the BIOS setup. Highlight any of the exit options then press **Enter**.

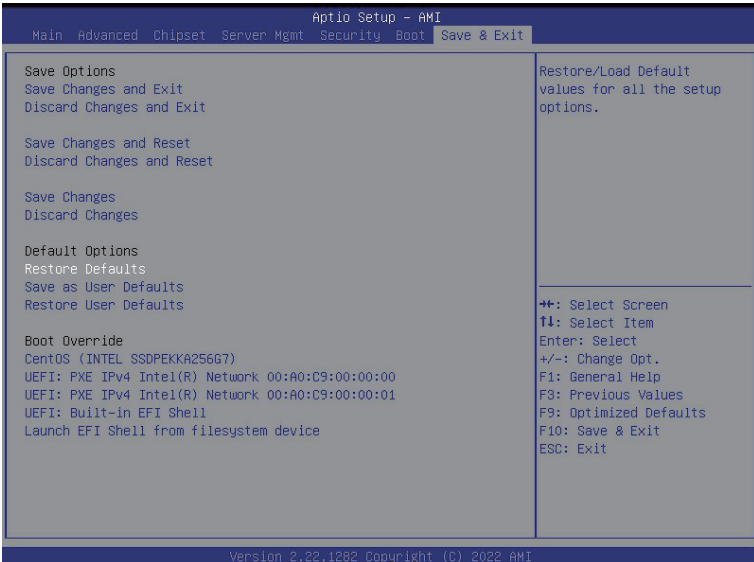

| Parameter | Description |
|--------------------------|---|
| Save Options | |
| Save Changes and Exit | Saves changes made and closes the BIOS setup. Options available: Yes/No. |
| Discard Changes and Exit | Discards changes made and exits the BIOS setup. Options available: Yes/No. |
| Save Changes | Save changes done so far to any of the setup options. Options available: Yes/No. |
| Default Options | |
| Restore Defaults | Loads the default settings for all BIOS setup parameters. Setup Defaults are quite demanding in terms of resources consumption. If you are using low-speed memory chips or other kinds of low-performance components and you choose to load these settings, the system might not function properly. Options available: Yes/No. |
| Boot Override | Press [Enter] to configure the device as the boot-up drive. |

5-8 BIOS POST Beep code (AMI standard)

5-8-1 PEI Beep Codes

| # of Beeps | Description |
|------------|--|
| 1 | Memory not Installed. |
| 1 | Memory was installed twice (InstallPeiMemory routine in PEI Core called twice) |
| 2 | Recovery started |
| 3 | DXE IPL was not found |
| 3 | DXE Core Firmware Volume was not found |
| 4 | Recovery failed |
| 4 | S3 Resume failed |
| 7 | Reset PPI is not available |

5-8-2 DXE Beep Codes

| # of Beeps | Description |
|------------|---|
| 1 | Invalid password |
| 4 | Some of the Architectural Protocols are not available |
| 5 | No Console Output Devices are found |
| 5 | No Console Input Devices are found |
| 6 | Flash update is failed |
| 7 | Reset protocol is not available |
| 8 | Platform PCI resource requirements cannot be met |