

GIGABYTE™

R243-E30-AAC1

R243-E30-AAH1

Rack Server - AMD EPYC™ 8004 - 2U UP 12-Bay Gen5 NVMe/SATA/SAS4

User Manual

Rev. 1.0

Copyright

© 2024 Giga Computing Technology CO., LTD. All rights reserved.

The trademarks mentioned in this manual are legally registered to their respective owners.

Disclaimer

Information in this manual is protected by copyright laws and is the property of Giga Computing. Changes to the specifications and features in this manual may be made by Giga Computing without prior notice. No part of this manual may be reproduced, copied, translated, transmitted, or published in any form or by any means without Giga Computing's prior written permission.

Documentation Classifications

In order to assist in the use of this product, Giga Computing provides the following types of documentation:

- User Manual: detailed information & steps about the installation, configuration and use of this product (e.g. motherboard, server barebones), covering hardware and BIOS.
- User Guide: detailed information about the installation & use of an add-on hardware or software component (e.g. BMC firmware, rail-kit) compatible with this product.
- Quick Installation Guide: a short guide with visual diagrams that you can reference easily for installation purposes of this product (e.g. motherboard, server barebones).

Please see the support section of the online product page to check the current availability of these documents.

For More Information

For related product specifications, the latest firmware and software, and other information please visit our website at <http://www.gigabyte.com/Enterprise>

For GIGABYTE distributors and resellers, additional sales & marketing materials are available from our reseller portal: <http://reseller.b2b.gigabyte.com>

For further technical assistance, please contact your GIGABYTE representative or visit <https://support.gigabyte.com/> to create a new support ticket

For any general sales or marketing enquiries, you may also message GIGABYTE server directly by email: server.grp@gigabyte.com

Conventions

The following conventions are used in this user's guide:

	NOTE! Gives bits and pieces of additional information related to the current topic.
	CAUTION! Gives precautionary measures to avoid possible hardware or software problems.
	WARNING! Alerts you to any damage that might result from doing or not doing specific actions.

Server Warnings and Cautions

Before installing a server, be sure that you understand the following warnings and cautions.



WARNING!

To reduce the risk of electric shock or damage to the equipment:

- Do not disable the power cord grounding plug. The grounding plug is an important safety feature.
- Plug the power cord into a grounded (earthed) electrical outlet that is easily accessible at all times.
- Unplug all the power cords from the power supplies to disconnect power to the equipment.

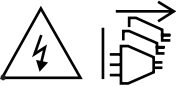

- Shock Hazard! Disconnect all power supply cords before servicing.
- Do not route the power cord where it can be walked on or pinched by items placed against it. Pay particular attention to the plug, electrical outlet, and the point where the cord extends from the server.



WARNING!

To reduce the risk of personal injury from hot surfaces, allow the drives and the internal system components to cool before touching them.



WARNING!

This server is equipped with high speed fans. Keep away from hazardous moving fan blades during servicing.



WARNING!

This equipment is intended to be used in Restrict Access Location. The access can only be gained by Skilled person. Only authorized by well trained professional person can access the restrict access location.



CAUTION!

- Do not operate the server for long periods with the access panel open or removed. Operating the server in this manner results in improper airflow and improper cooling that can lead to thermal damage.
- Danger of explosion if battery is incorrectly replaced.
- Replace only with the same or equivalent type recommended by the manufacturer.
- Dispose of used batteries according to the manufacturer's instructions.



CAUTION!

Risk of explosion if battery is replaced incorrectly or with an incorrect type. Replace the battery only with the same or equivalent type recommended by the manufacturer. Dispose of used batteries according to the manufacturer's instructions.

Electrostatic Discharge (ESD)



CAUTION!

ESD CAN DAMAGE DRIVES, BOARDS, AND OTHER PARTS. WE RECOMMEND THAT YOU PERFORM ALL PROCEDURES AT AN ESD WORKSTATION. IF ONE IS NOT AVAILABLE, PROVIDE SOME ESD PROTECTION BY WEARING AN ANTI-STATIC WRIST STRAP ATTACHED TO CHASSIS GROUND -- ANY UNPAINTED METAL SURFACE -- ON YOUR SERVER WHEN HANDLING PARTS.

Always handle boards carefully. They can be extremely sensitive to ESD. Hold boards only by their edges without any component and pin touching. After removing a board from its protective wrapper or from the system, place the board component side up on a grounded, static free surface. Use a conductive foam pad if available but not the board wrapper. Do not slide board over any surface.

System power on/off: To remove power from system, you must remove the system from rack. Make sure the system is removed from the rack before opening the chassis, adding, or removing any non hot-plug components.

Hazardous conditions, devices and cables: Hazardous electrical conditions may be present on power, telephone, and communication cables. Turn off the system and disconnect the cables attached to the system before servicing it. Otherwise, personal injury or equipment damage can result.

Electrostatic discharge (ESD) and ESD protection: ESD can damage drives, boards, and other parts. We recommend that you perform all procedures in this chapter only at an ESD workstation. If one is not available, provide some ESD protection by wearing an antistatic wrist strap attached to chassis ground (any unpainted metal surface on the server) when handling parts.

ESD and handling boards: Always handle boards carefully. They can be extremely sensitive to electrostatic discharge (ESD). Hold boards only by their edges. After removing a board from its protective wrapper or from the system, place the board component side up on a grounded, static free surface. Use a conductive foam pad if available but not the board wrapper. Do not slide board over any surface.

Installing or removing jumpers: A jumper is a small plastic encased conductor that slips over two jumper pins. Some jumpers have a small tab on top that can be gripped with fingertips or with a pair of fine needle nosed pliers. If the jumpers do not have such a tab, take care when using needle nosed pliers to remove or install a jumper; grip the narrow sides of the jumper with the pliers, never the wide sides. Gripping the wide sides can damage the contacts inside the jumper, causing intermittent problems with the function controlled by that jumper. Take care to grip with, but not squeeze, the pliers or other tool used to remove a jumper, or the pins on the board may bend or break.

Table of Contents

Chapter 1 Hardware Installation	9
1-1 Installation Precautions	9
1-2 Product Specifications	10
1-3 System Block Diagram	14
Chapter 2 System Appearance	15
2-1 Front View	15
2-2 Rear View	16
2-3 Front Panel LEDs and Buttons	17
2-3-1 RoT LEDs	18
2-4 Rear System LAN LEDs	20
2-5 Power Supply Unit (PSU) LED	21
2-6 Hard Disk Drive LEDs	22
Chapter 3 System Hardware Installation	23
3-1 Removing Chassis Cover	24
3-2 Removing and Installing the Fan Duct	25
3-3 Removing and installing the Heat Sink	26
3-4 Installing the CPU	27
3-5 Installing the Memory	28
3-5-1 Six Channel Memory Configuration	28
3-5-2 Installing the Memory	29
3-5-3 DIMM Population Table	30
3-5-4 Processor and Memory Module Matrix Table	30
3-6 Installing the PCI Expansion Card	31
3-7 Installing the Mezzanine Card	32
3-7-1 OCP 3.0	32
3-8 Installing the Hard Disk Drive	33
3-9 Installing the M.2 Device and Heat Sink	35
3-10 Replacing the Fan Assembly	36
3-11 Replacing the Power Supply	37
3-12 Cable Routing	38
Chapter 4 Motherboard Components	41
4-1 Motherboard Components	41
4-2 Jumper Setting	43

4-3	Backplane Board Storage Connector	44
4-3-1	CBP20C7.....	44
Chapter 2	BIOS Setup	45
2-1	The Main Menu	47
2-2	Advanced Menu	50
2-2-1	Trusted Computing.....	51
2-2-2	PSP Firmware Versions.....	52
2-2-3	Legacy Video Select.....	53
2-2-4	AST2600 Super IO Configuration.....	54
2-2-5	S5 RTC Wake Settings.....	56
2-2-6	Serial Port Console Redirection	57
2-2-7	CPU Configuration.....	61
2-2-8	PCI Subsystem Settings.....	62
2-2-9	USB Configuration.....	64
2-2-10	Network Stack Configuration	66
2-2-11	Post Report Configuration	67
2-2-12	NVMe Configuration	68
2-2-13	SATA Configuration.....	69
2-2-14	Graphic Output Configuration.....	70
2-2-15	AMD Mem Configuration Status.....	71
2-2-16	Tls Auth Configuration	72
2-2-17	RAM Disk Configuration	73
2-2-18	iSCSI Configuration	74
2-2-19	Intel(R) I210 Gigabit Network Connection	75
2-2-20	VLAN Configuration.....	77
2-2-21	MAC IPv4 Network Configuration	78
2-2-22	MAC IPv6 Network Configuration	79
2-3	AMD CBS Menu.....	80
2-3-1	CPU Common Options	81
2-3-2	DF Common Options.....	87
2-3-3	UMC Common Options	94
2-3-4	NBIO Common Options.....	115
2-3-5	FCH Common Options	126
2-3-6	SOC Miscellaneous Control	135
2-3-7	CXL Common Options.....	137
2-4	AMD PBS Menu	138
2-4-1	RAS.....	139
2-5	Chipset Setup Menu.....	141
2-5-1	North Bridge	142

2-5-2	Fabric Resource	143
2-6	Server Management Menu.....	145
2-6-1	System Event Log	147
2-6-2	View FRU Information	148
2-6-3	BMC Network Configuration.....	149
2-6-4	IPv6 BMC Network Configuration.....	150
2-7	Security Menu	151
2-7-1	Secure Boot	152
2-8	Boot Menu.....	154
2-9	Save & Exit Menu.....	156
2-10	BIOS Recovery	157
2-11	BIOS POST Beep code (AMI standard).....	158
2-11-1	PEI Beep Codes	158
2-11-2	DXE Beep Codes	158

Chapter 1 Hardware Installation

1-1 Installation Precautions

The motherboard/system contain numerous delicate electronic circuits and components which can become damaged as a result of electrostatic discharge (ESD). Prior to installation, carefully read the service guide and follow these procedures:

- Prior to installation, do not remove or break motherboard S/N (Serial Number) sticker or warranty sticker provided by your dealer. These stickers are required for warranty validation.
- Always remove the AC power by unplugging the power cord from the power outlet before installing or removing the motherboard or other hardware components.
- When connecting hardware components to the internal connectors on the motherboard, make sure they are connected tightly and securely.
- When handling the motherboard, avoid touching any metal leads or connectors.
- It is best to wear an electrostatic discharge (ESD) wrist strap when handling electronic components such as a motherboard, CPU or memory. If you do not have an ESD wrist strap, keep your hands dry and first touch a metal object to eliminate static electricity.
- Prior to installing the motherboard, please have it on top of an antistatic pad or within an electrostatic shielding container.
- Before unplugging the power supply cable from the motherboard, make sure the power supply has been turned off.
- Before turning on the power, make sure the power supply voltage has been set according to the local voltage standard.
- Before using the product, please verify that all cables and power connectors of your hardware components are connected.
- To prevent damage to the motherboard, do not allow screws to come in contact with the motherboard circuit or its components.
- Make sure there are no leftover screws or metal components placed on the motherboard or within the computer casing.
- Do not place the computer system on an uneven surface.
- Do not place the computer system in a high-temperature environment.
- Turning on the computer power during the installation process can lead to damage to system components as well as physical harm to the user.
- If you are uncertain about any installation steps or have a problem related to the use of the product, please consult a certified computer technician.







1-2 Product Specifications



NOTE:

We reserve the right to make any changes to the product specifications and product-related information without prior notice.

	System Dimension	<ul style="list-style-type: none"> ◆ 2U ◆ 438mm (W) x 87.5mm (H) x 710mm (D)
	CPU	<ul style="list-style-type: none"> ◆ AMD EPYC™ 8004 Series Processors ◆ Single processor, 5nm technology ◆ Up to 64 cores, 128 threads ◆ cTDP up to 225W
	Socket	<ul style="list-style-type: none"> ◆ 1 x LGA 4844 ◆ Socket SP6
	Chipset	<ul style="list-style-type: none"> ◆ System on Chip
	Security	<ul style="list-style-type: none"> ◆ UEFI Secure Boot ◆ Silicon root of trust (Option) ◆ SNMP Support: V3
	Memory	<ul style="list-style-type: none"> ◆ 12 x DIMM slots ◆ DDR5 memory supported only ◆ 6-Channel memory architecture ◆ RDIMM up to 96GB supported ◆ Memory speed: Up to 4800 MT/s (1DPC), 3600 MT/s (2DPC)
	LAN	<p>Rear side:</p> <ul style="list-style-type: none"> ◆ 1 x 1Gb/s LAN port (1 x Intel® I210-AT) ◆ Supports NCSI function <ul style="list-style-type: none"> ◆ 1 x 10/100/1000 Mbps Management LAN
	Video	<ul style="list-style-type: none"> ◆ Integrated in Aspeed® AST2600 ◆ 2D Video Graphic Adapter with PCIe bus interface ◆ 1920x1200@60Hz 32bpp
	Storage	<p>Front side:</p> <ul style="list-style-type: none"> ◆ 4 x 3.5"/2.5" Gen5 NVMe/SATA/SAS-4* hot-swappable bays ◆ 8 x 3.5"/2.5" SATA/SAS-4* hot-swappable bays <p>*SAS card is required to support SAS drives.</p>
	SAS	<ul style="list-style-type: none"> ◆ Require SAS add-in cards
	RAID	<ul style="list-style-type: none"> ◆ Require RAID add-in cards

	Expansion Slot	<ul style="list-style-type: none"> ◆ Riser Card CRS201H: <ul style="list-style-type: none"> - 1 x PCIe x16 (Gen5 x16) FHHL slot ◆ Riser Card CRS201M: <ul style="list-style-type: none"> - 1 x PCIe x16 (Gen5 x16) FHHL slot ◆ 2 x OCP 3.0 slots with PCIe Gen5 x16 bandwidth <ul style="list-style-type: none"> - Support NCSI function ◆ 1 x M.2 slot: <ul style="list-style-type: none"> - M-key - PCIe Gen3 x4 - Supports 2280/22110 cards
	Internal I/O	<ul style="list-style-type: none"> ◆ 1 x TPM header
	Front I/O	<ul style="list-style-type: none"> ◆ 2 x USB 3.2 Gen1 ◆ 1 x Power button with LED ◆ 1 x ID button with LED ◆ 1 x NMI button ◆ 1 x Reset button ◆ 2 x LAN activity LEDs (1 x LED disabled) ◆ 1 x Storage activity LED ◆ 1 x System status LED
	Rear I/O	<ul style="list-style-type: none"> ◆ 2 x USB 3.2 Gen1 ◆ 1 x Mini-DP ◆ 1 x RJ45 ◆ 1 x MLAN ◆ 1 x ID button with LED
	Backplane I/O	<ul style="list-style-type: none"> ◆ Speed and bandwidth: PCIe Gen5 x4 or SATA 6Gb/s or SAS-4 24Gb/s
	TPM	<ul style="list-style-type: none"> ◆ 1 x TPM header with SPI interface ◆ Optional TPM2.0 kit: CTM010



Power Supply

R243-Z30-AAC1

- ◆ 1+1 1300W 80 PLUS Platinum redundant power supplies

- ◆ AC Input:
 - 100-240V~/ 12-7A, 50-60Hz
 - 200-240V~/ 8A, 50-60Hz

- ◆ DC Input: (Only for China)
 - 240Vdc/ 6.5A

- ◆ DC Output:
 - Max 1000W/ 100-240V~
 - + 12V/ 80.5A
 - + 12Vsb/ 3A
 - Max 1300W at 200-240V~ or 240Vdc Input
 - + 12V/ 105.4A
 - + 12Vsb/ 3A

R243-E30-AAH1

- ◆ 1+1 1300W 80 PLUS Titanium redundant power supplies

- ◆ AC Input:
 - 100-127V ~/ 12A, 50-60Hz
 - 200-240V~/ 8A, 50-60Hz

- ◆ DC Input: (Only for China)
 - 240Vdc/ 7A

- ◆ DC Output:
 - Max 1000W/ 100-127V~
 - + 12.2V/ 82A
 - + 12.2Vsb/ 3A
 - Max 1300W at 200-240V~ or 240Vdc Input
 - + 12.2V/ 106A
 - + 12.2Vsb/ 3A

NOTE:

- ◆ The default power supply is based on a basic system configuration. Please contact with technical representatives to determine the best power supply selection for your system configuration requirements and preferred efficiency.
- ◆ The power supply specifications provided herein is for the default server configuration. Different SKUs have different PSU specs, so please see the system rating label on the server for the accurate PSU specification.



System Management

- ◆ Aspeed® AST2600 management controller
- ◆ GIGABYTE Management Console (AMI MegaRAC SP-X) web interface

- ◆ Dashboard
- ◆ HTML5 KVM
- ◆ Sensor Monitor (Voltage, RPM, Temperature, CPU Status ...etc.)
- ◆ Sensor Reading History Data
- ◆ FRU Information
- ◆ SEL Log in Linear Storage / Circular Storage Policy
- ◆ Hardware Inventory
- ◆ Fan Profile
- ◆ System Firewall
- ◆ Power Consumption
- ◆ Power Control
- ◆ Advanced power capping
- ◆ LDAP / AD / RADIUS Support
- ◆ Backup & Restore Configuration
- ◆ Remote BIOS/BMC/CPLD Update
- ◆ Event Log Filter
- ◆ User Management
- ◆ Media Redirection Settings
- ◆ PAM Order Settings
- ◆ SSL Settings
- ◆ SMTP Settings



Operating Properties

- ◆ Operating temperature: 10°C to 35°C
- ◆ Operating humidity: 8-80% (non-condensing)
- ◆ Non-operating temperature: -40°C to 60°C
- ◆ Non-operating humidity: 20%-95% (non-condensing)

1-3 System Block Diagram

6-Channel DDR5, 12 x DIMMs
Up to 4800 MHz (1DPC) / 3600 MHz (2DPC)

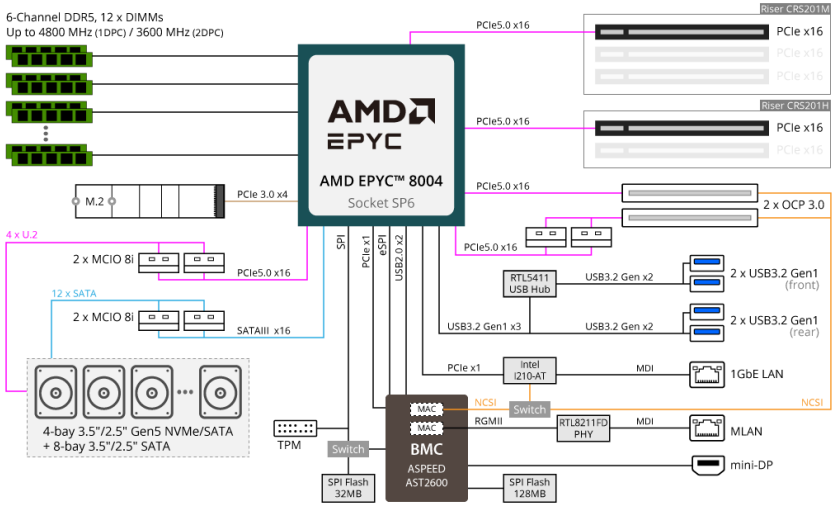

Chapter 2 System Appearance

2-1 Front View

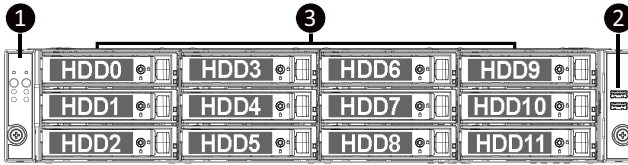

No.	Description
1.	Front Panel LEDs and Buttons
2.	Front USB 3.2 Gen1 Ports
3.	3.5"/2.5" Drive Bays
Note! Drives with green latches support NVMe.	



- Please Go to Chapter 2-3 Front Panel LED and Buttons for detail description of function LEDs.

2-2 Rear View

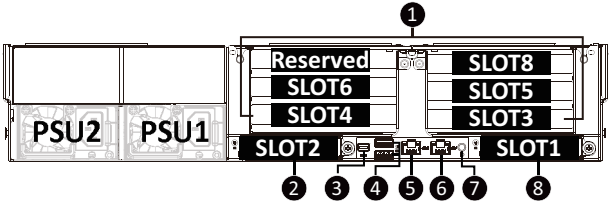

No.	Description
1.	PCIe Slot
2.	OCP 3.0 Slot (Option/SFF)
3.	Mini DisplayPort
4.	USB 3.2 Gen1 Port x 2
5.	10/100/1000 Server Management LAN Port
6.	1GbE LAN Port
7.	ID Button
8.	OCP 3.0 Slot (Option/SFF)

2-3 Front Panel LEDs and Buttons

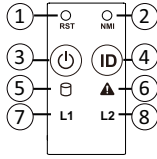

No.	Name	Color	Status	Description	
1.	Reset Button			Press the button to reset the system.	
2.	NMI button			Press the button server generates a NMI to the processor if the multiple-bit ECC errors occur, which effectively halt the server.	
3.	Power button with LED	Green	On	System is powered on	
		Green	Blink	System is in ACPI S1 state (sleep mode)	
		N/A	Off	<ul style="list-style-type: none"> System is not powered on or in ACPI S5 state (power off) System is in ACPI S4 state (hibernate mode) 	
4.	ID Button ^(Note)			Press the button to activate system identification	
5.	HDD Status LED	Green	On	HDD locate	
			Blink	HDD access	
		Amber	On	HDD fault	
		Green/Amber	Blink	HDD rebuilding	
		N/A	Off	No HDD access or no HDD fault.	
6.	System Status LED ^(Note)	Green	On	System is operating normally.	
			Amber	On	Critical condition, may indicate: System fan failure; System temperature
				Blink	Non-critical condition, may indicate: Redundant power module failure Temperature and voltage issue Chassis intrusion
		N/A	Off	System is not ready, may indicate: POST error; NMI error; Processor or terminator missing	
7.	LAN 1 Active/Link LED	Green	On	Link between system and network or no access.	
			Blink	Data transmission or receiving is occurring	
			Off	No data transmission or receiving is occurring	
8.	LAN 2 Active/Link LED			The function is disabled.	

(Note) If your server features RoT function, please see the following section for detail LED behavior.

2-3-1 RoT LEDs

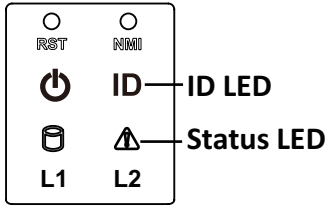

LED on Front panel ^(Note5)		
	ID LED	Status LED
EC Firmware (FW) Authentication fail or not exit		
EC FW is broken or not exit ^(Note1)	OFF	OFF
Authenticating/Recovering BMC/BIOS Images		
Authenticating Images	OFF	OFF
Recovering BMC Active Flash	Blinks Blue 4 times per second	Blinks Green 4 times per second
Recovering BIOS Active Flash	Blinks Blue 4 times per second	Blinks Green 4 times per second
Authentication (AUTH) Pass		
Recovering BIOS Active Flash	OFF	OFF
BMC : AUTH pass after doing recovery	OFF	OFF
BIOS : AUTH pass after doing recovery	OFF	OFF
BMC : AUTH pass	OFF	OFF
BIOS : AUTH pass after doing recovery	OFF	OFF
Active Flash Authentication (AUTH) Fail		
BMC : AUTH Fail ^(Note2)	Blinks Blue 1 time per second	Blinks Green 1 time per second

BIOS : AUTH fail^(Note2)	Blinks Blue 1 time per second	Blinks Amber 1 time per second
BMC : AUTH fail after doing recovery^(Note3)	Blinks Blue 2 times per second [ON OFF OFF]	Blinks Green 2 times per second [ON OFF OFF]
BIOS : AUTH fail after doing recovery^(Note3)	Blinks Blue 2 times per second [ON OFF OFF]	Blinks Amber 2 times per second [ON OFF OFF]
Backup Flash Authentication Fail^(Note4)		
BMC : AUTH fail	Blinks Blue 2 times per second [ON OFF ON OFF]	Blinks Green 2 times per second [ON OFF ON OFF]
BIOS : AUTH fail	Blinks Blue 2 times per second [ON OFF ON OFF]	Blinks Amber 2 times per second [ON OFF ON OFF]

NOTE!

1. EC FW is broken or not exited result in Microchip CEC1702 cannot load EC FW for authentication.
2. (1) Authentication fail include below scenarios
Configuration table is missing or modified
Public key is missing or modified
Protected area or signature is modified
Flash empty
3. If active flash is still authentication failed after recovery sequence, Microchip CEC1702 stop the process and showing LED behavior.
4. If backup flash authentication is failed cause by configuration table, public key or protected area is broken. Microchip CEC1702 stop the process and showing LED behavior.
5. Front panel LED is controlled by BMC or Microchip CEC1702. Once Microchip CEC1702 is working(Auth or recovery), the front panel LED is controlled by Microchip CEC1702 and vice versa.

2-4 Rear System LAN LEDs

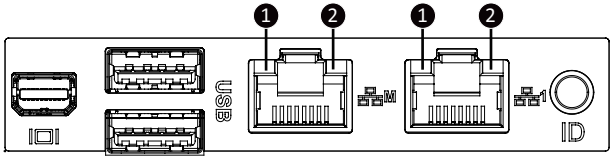

No.	Name	Color	Status	Description
1.	1GbE Speed LED	Yellow	On	1 Gbps data rate
		Green	On	100 Mbps data rate
		N/A	Off	10 Mbps data rate
2.	1GbE Link/Activity LED	Green	On	Link between system and network or no access
			Blink	Data transmission or receiving is occurring
		N/A	Off	No data transmission or receiving is occurring

2-5 Power Supply Unit (PSU) LED



NOTE!

The power supply may be vary based on the system configuration.

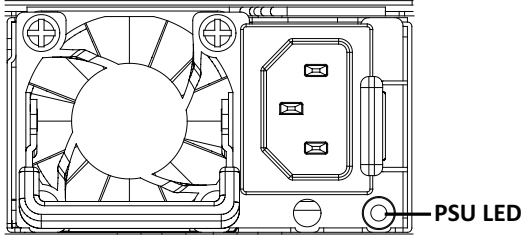

State	Description
OFF	No AC power to all power supplies
1Hz Green Blinking	AC present / only standby on / Cold redundant mode
2Hz Green Blinking	Power supply firmware updating mode
Amber	AC cord unplugged or AC power lost; with a second power supply in parallel still with AC input power
	Power supply critical event causing shut down: failure, OCP, OVP, fan failure and UVP
1Hz Amber Blinking	Power supply warning events where the power supply continues to operate: high temp, high power, high current and slow fan

2-6 Hard Disk Drive LEDs

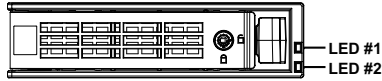

RAID SKU		LED #1	Locate	HDD Fault	Rebuilding	HDD Access	HDD Present (No Access)
No RAID configuration (via HBA)	Disk LED (LED on Back Panel)	Green	ON(*1)	OFF		BLINK (*2)	OFF
		Amber	OFF	OFF		OFF	OFF
	Removed HDD Slot (LED on Back Panel)	Green	ON(*1)	OFF		--	--
		Amber	OFF	OFF		--	--
RAID configuration (via HW RAID Card or SW RAID Card)	Disk LED	Green	ON	OFF		BLINK (*2)	OFF
		Amber	OFF	ON	(Low Speed: 2 Hz)	OFF	OFF
	Removed HDD Slot	Green	ON(*1)	OFF	(*3)	--	--
		Amber	OFF	ON	(*3)	--	--

LED #2	HDD Present	No HDD
Green	ON	OFF

NOTE:

*1: Depends on HBA/Utility Spec.

*2: Blink cycle depends on HDD's activity signal.

*3: If HDD is pulled out during rebuilding, the disk status of this HDD is regarded as faulty.

Chapter 3 System Hardware Installation



Pre-installation Instructions

Computer components and electronic circuit boards can be damaged by electrostatic discharge. Working on computers that are still connected to a power supply can be extremely dangerous. Follow the simple guidelines below to avoid damage to your computer or injury to yourself.

- Always disconnect the computer from the power outlet whenever you are working inside the computer case.
- If possible, wear a grounded wrist strap when you are working inside the computer case. Alternatively, discharge any static electricity by touching the bare metal system of the computer case, or the bare metal body of any other grounded appliance.
- Hold electronic circuit boards by the edges only. Do not touch the components on the board unless it is necessary to do so. Do not flex or stress the circuit board.
- Leave all components inside the static-proof packaging until you are ready to use the component for the installation.

3-1 Removing Chassis Cover



Before you remove or install the system cover

- Make sure the system is not turned on or connected to AC power.

Follow these instructions to remove the chassis cover:

1. Remove the screw securing the chassis cover.
2. Push button to unlock the handle.
3. Pull the grip handle to open the panel cover.
4. Slide the chassis cover towards the rear and remove the chassis cover in the direction indicated.
5. To reinstall the chassis cover reverse steps 1-4.

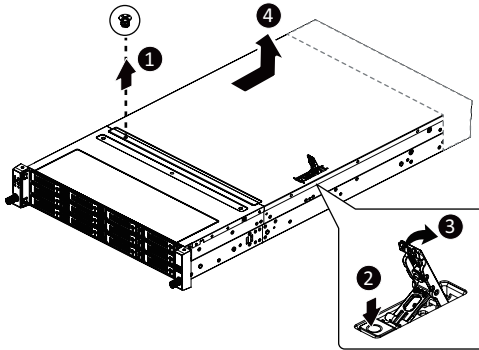

3-2 Removing and Installing the Fan Duct

Follow these instructions to remove/install the fan duct:

1. Lift up to remove the fan duct
2. To install the fan duct, align the fan duct with the guiding groove. Push down the fan duct into chassis until its firmly seat.

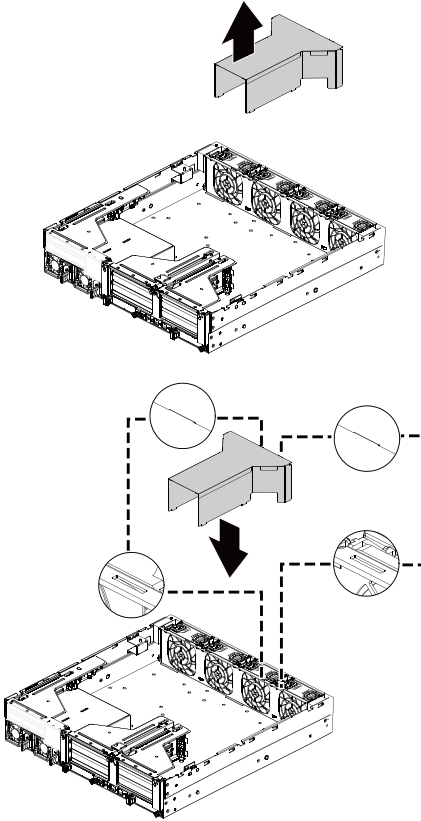

3-3 Removing and installing the Heat Sink



Read the following guidelines before you begin to remove/install the heat sink:

- Always turn off the computer and unplug the power cord from the power outlet before installing the heat sink to prevent hardware damage.
- Unplug all cables from the power outlets.
- Disconnect all telecommunication cables from their ports.
- Place the system unit on a flat and stable surface.
- Open the system according to the instructions.



WARNING!

Failure to turn off the server before you start installing components may cause serious damage. Do not attempt the procedures described in the following sections unless you are a qualified service technician.

Follow these instructions to remove/install the heat sink:

1. Loosen the captive screws securing the heat sink in place in reverse order (4→3→2→1).
2. Lift and remove the heat sink from the system.
3. To reinstall the heat sink reverse steps 1-2 while ensuring that you tighten the captive screws in sequential order (1→2→3→4) as seen in the image below.

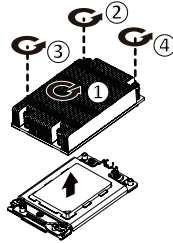

- When installing the heat sink to CPU, use T-20 6-Lobe screwdriver to tighten 4 captive nuts in sequence as 1-4. The screw tightening torque: 13.8 ± 1.3 kgf-cm.
- To ensure the system operates properly, make sure the heat sink is seated on the processor firmly.

3-4 Installing the CPU



Read the following guidelines before you begin to install the CPU:

- Make sure that the motherboard supports the CPU.
- Always turn off the computer and unplug the power cord from the power outlet before installing the CPU to prevent hardware damage.
- Unplug all cables from the power outlets.
- Disconnect all telecommunication cables from their ports.
- Place the system unit on a flat and stable surface.
- Open the system according to the instructions.



WARNING!

Failure to properly turn off the server before you start installing components may cause serious damage. Do not attempt the procedures described in the following sections unless you are a qualified service technician.

Follow these instructions to install the CPU:

1. Loosen the three captive screws securing the CPU cover in sequential order (1 → 2 → 3).
2. Flip open the CPU cover.
3. Remove the CPU carrier from the CPU frame using the handle on the CPU carrier.
4. Using the handle on the CPU carrier insert the new CPU carrier with CPU installed into the CPU frame.

NOTE: Ensure the CPU is installed in the CPU carrier in the correct orientation, with the triangle on the CPU aligned to the top left corner of the CPU carrier.

5. Flip the CPU frame with CPU installed into place in the CPU socket.
6. Flip the CPU cover into place over the CPU socket.
7. Tighten the CPU cover screws in sequential order (1 → 2 → 3) to secure the CPU cover in place.

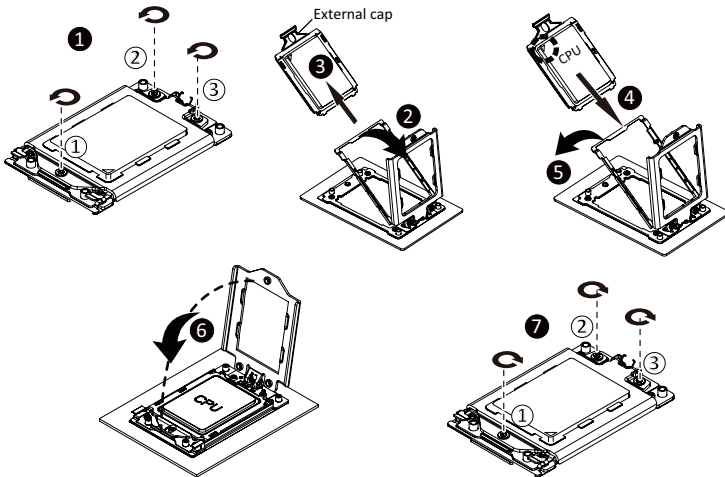

- Tighten the CPU cover screws, use T-20 6-Lobe driver to tighten 3 captive nuts in sequence as 1-3.
- The screw tightening torque: 13.8 ± 1.3 kgf-cm.

3-5 Installing the Memory



Read the following guidelines before you begin to install the memory:

- Make sure that the motherboard supports the memory. It is recommended that memory of the same capacity, brand, speed, and chips be used.
- Always turn off the computer and unplug the power cord from the power outlet before installing the memory to prevent hardware damage.
- Memory modules have a foolproof design. A memory module can be installed in only one direction. If you are unable to insert the memory, switch the direction.

3-5-1 Six Channel Memory Configuration

This motherboard provides 12 DDR5 memory slots and supports 6-Channel Technology. After the memory is installed, the BIOS will automatically detect the specifications and capacity of the memory.

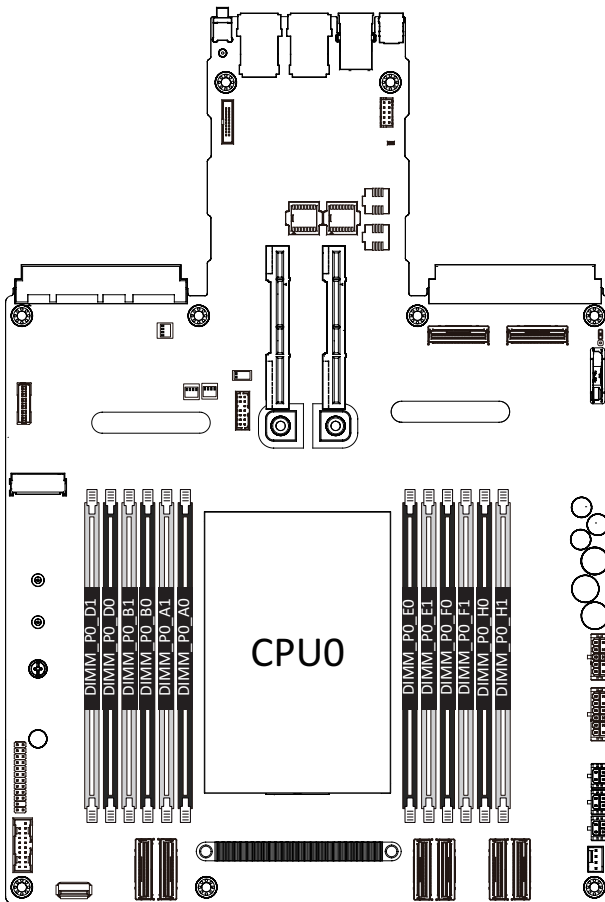

3-5-2 Installing the Memory



Before installing a memory module, make sure to turn off the computer and unplug the power cord from the power outlet to prevent damage to the memory module.

Be sure to install DDR5 DIMMs on this motherboard.

Make sure your DIMM slots have a single latch or a double latch.

Follow these instructions to install a DIMM module with Single Latch :

1. Open the plastic latch of the memory slot, then place the memory module as pre-inserted vertically position.

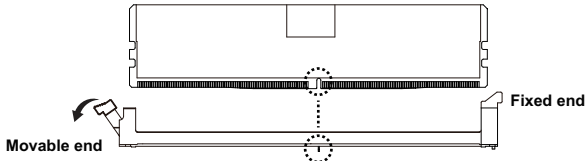

2. Hold it with both hands, insert the memory module into the movable end first, and then insert the memory module into the fixed end.

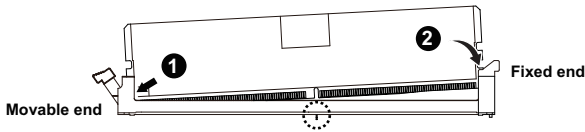

3. Then use both hands to insert the memory module vertically into the DIMM slot and push it down. Close the plastic latch at the edge of the DIMM slots to lock the memory module.

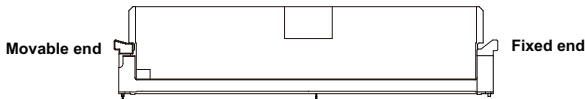

4. Reverse the installation steps when you want to remove the memory module.

Follow these instructions to install a DIMM module with Double Latch:

1. Insert the DIMM memory module vertically into the DIMM slot and push it down.
2. Close the plastic clip at both edges of the DIMM slots to lock the DIMM module.
3. Reverse the installation steps when you want to remove the DIMM module.

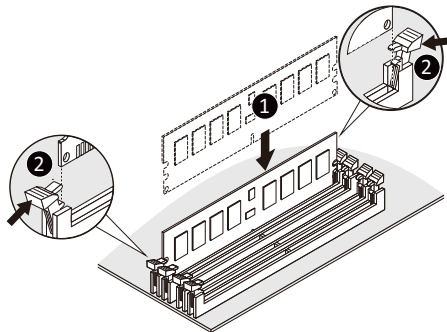

3-5-3 DIMM Population Table

DIMM Type	DIMM Population		DDR5 Frequency (MT/s)
	DIMM 0	DIMM 1	14-layer 77mil PCB stackup
RDIMM	--	1R	4800
	1R	1R	4000
	--	2R	4800
	2R	2R	3600

3-5-4 Processor and Memory Module Matrix Table

Memory Q'ty	CPU0											
	D1	D0	B1	B0	A1	A0	E0	E1	F0	F1	H0	H1
1 DIMM					v							
2 DIMM					v			v				
4 DIMM	v				v			v				v
6 DIMM	v		v		v			v		v		v
8 DIMM	v	v			v	v	v	v			v	v
12 DIMM	v	v	v	v	v	v	v	v	v	v	v	v

3-6 Installing the PCI Expansion Card



- Voltages can be present within the server whenever an AC power source is connected. This voltage is present even when the main power switch is in the off position. Ensure that the system is powered-down and all power sources have been disconnected from the server prior to installing a PCIe card.

Failure to observe these warnings could result in personal injury or damage to equipment.



- The PCIe riser assembly does not include a riser card or any cabling as standard. To install a PCIe card, a riser card must be installed.

Follow these instructions for a PCI Expansion card:

1. Remove the screws and loosen the thumbscrew securing the riser bracket.
2. Lift up the riser bracket out of system.
3. Remove the screw securing the slot cover from the riser bracket.
4. Remove the slot covers from the riser bracket.
5. Orient the PCIe card with the riser guide slot and push in the direction of the arrow until the PCIe card sits in the PCIe card connector.
6. Secure the PCIe card with the screw.
7. Reverse the previous steps to install the riser bracket.

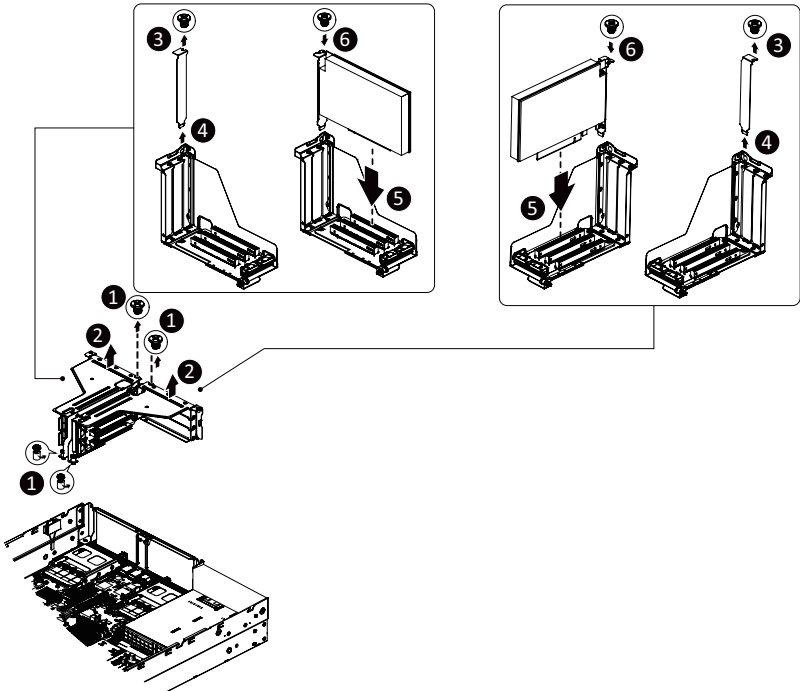

3-7 Installing the Mezzanine Card

3-7-1 OCP 3.0



Use of the following type of OCP 3.0 NIC is recommended:

- OCP 3.0 SFF with Pull Tab
- OCP 3.0 SFF with Ejector Latch

Follow these instructions to install an OCP 3.0 mezzanine card:

1. Remove the two screws securing the mezzanine card slot cover.
2. Remove the slot cover from the system.
3. Insert the OCP 3.0 mezzanine card into the card slot ensuring that the card is firmly connected to the connector on the motherboard.
4. Tighten the thumbnail screw to secure the OCP 3.0 mezzanine card in place.
5. Reverse the previous steps to replace the OCP 3.0 mezzanine card.

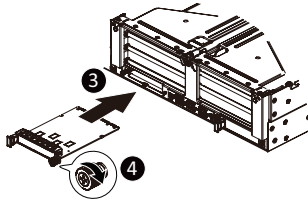
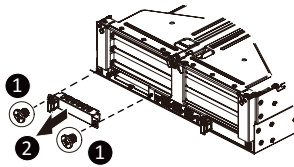

3-8 Installing the Hard Disk Drive



Read the following guidelines before you begin to install the HDD:

- Take note of the drive tray orientation before sliding it out.
- The tray will not fit back into the bay if inserted incorrectly.
- Make sure that the HDD is connected to the HDD connector on the backplane.

Follow these instructions to install a 3.5" HDD:

1. Press the release button.
2. Extend the locking lever.
3. Pull the locking lever in the direction indicated to remove the HDD tray.
4. Slide the hard disk drive into the HDD tray.
5. Reinsert the HDD tray into the slot and close the locking lever.

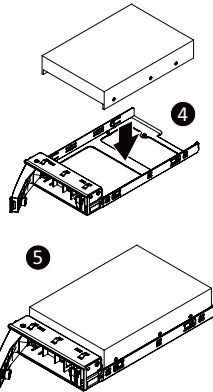
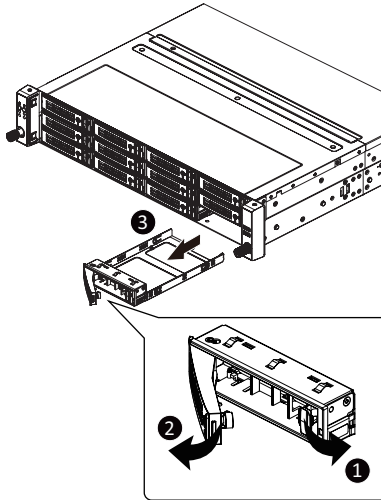

Follow these instructions to install 2.5" hard disk drive into 3.5" HDD Tray:

1. Press the release button.
2. Extend the locking lever.
3. Pull the locking lever in the direction indicated to remove the HDD tray.
4. Align the hard disk drive with the positioning screw on the HDD tray.
5. Secure the hard disk drive with five screws.
6. Reinsert the HDD tray into the slot and close the locking lever.

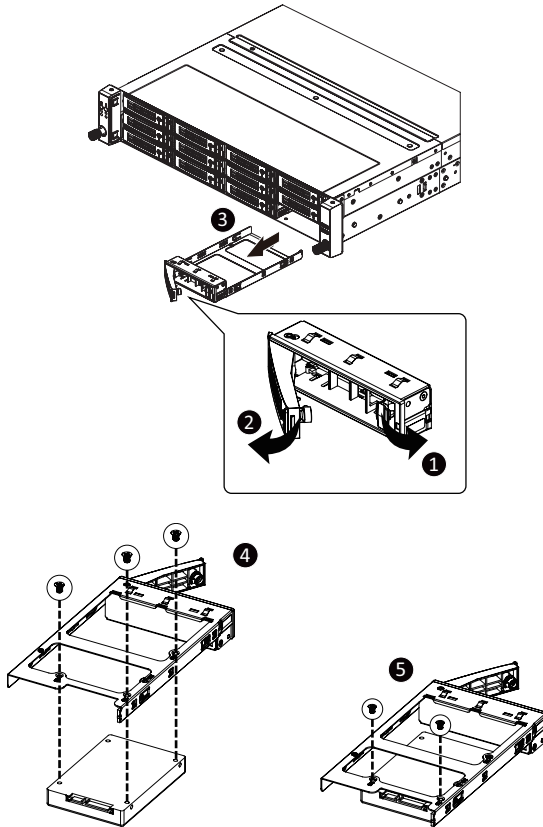

3-9 Installing the M.2 Device and Heat Sink



CAUTION

The position of the stand-off screw will depend on the size of the M.2 device. The stand-off screw is pre-installed for 22110 cards as standard. Refer to the size of the M.2 device and change the position of the stand-off screw accordingly.



WARNING:

Please ensure a heat sink is attached to any M.2 device installed into the system. Installing an M.2 device without any heat sink may result in the system overheating or system performance being throttled.



- To install/remove the M.2 module and Heat sink use a No. 1 Phillips-head screwdriver with a screw torque of $1.5 \pm 0.2 \text{ kg}^{\circ}\text{cm}$

Follow these instructions to install the M.2 device and heat sink:

1. Insert the M.2 device into the M.2 connector.
2. Press down on the M.2 device.
3. Install the thermal pad of the M.2 device to the M.2 device.
4. Press down on the thermal pad.
5. Secure the M.2 device and its thermal pad to the motherboard with a single screw.
6. Reverse steps 1-2 to remove the M.2 device.

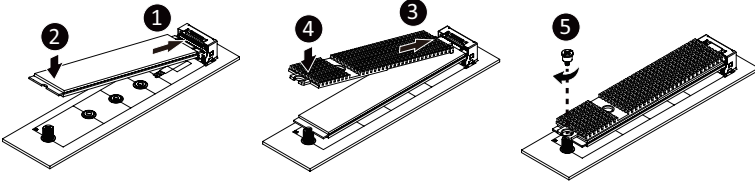

3-10 Replacing the Fan Assembly



- Voltages can be present within the server whenever an AC power source is connected. This voltage is present even when the main power switch is in the off position. Ensure that the system is powered-down and all power sources have been disconnected from the server prior to replacing a system fan.
- Failure to observe these warnings could result in personal injury or damage to equipment.

Follow these instructions to replace the fan assembly:

1. Pull outward the fan ear.
2. Lift up the fan assembly from the chassis.
3. Reverse the previous steps to install the replacement fan assembly.

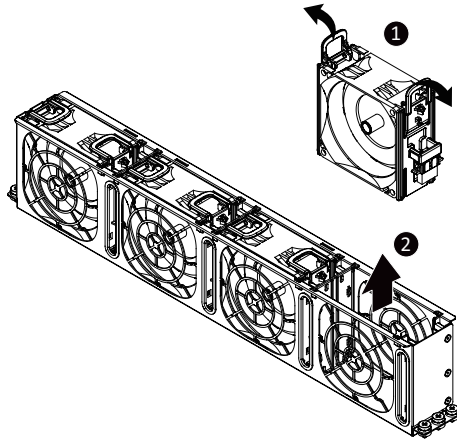

3-11 Replacing the Power Supply



CAUTION!

- In order to reduce the risk of injury from electric shock, disconnect AC power from the power supply before removing the power supply from the system

Follow these instructions to replace the power supply:

1. Flip and then grasp the power supply handle.
2. Press the retaining clip on the top side of the power supply in the direction indicated.
3. Pull out the power supply using the handle.
4. Insert the replacement power supply firmly into the chassis. Connect the AC power cord to the replacement power supply.

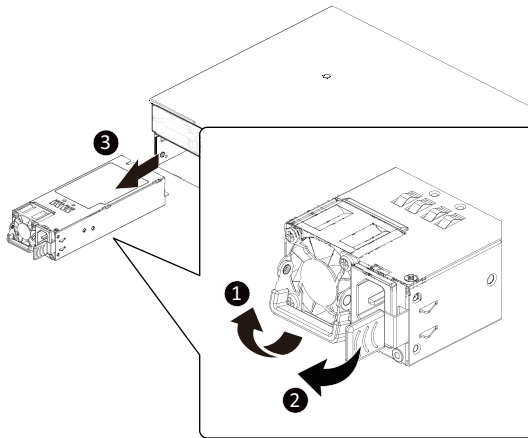

3-12 Cable Routing

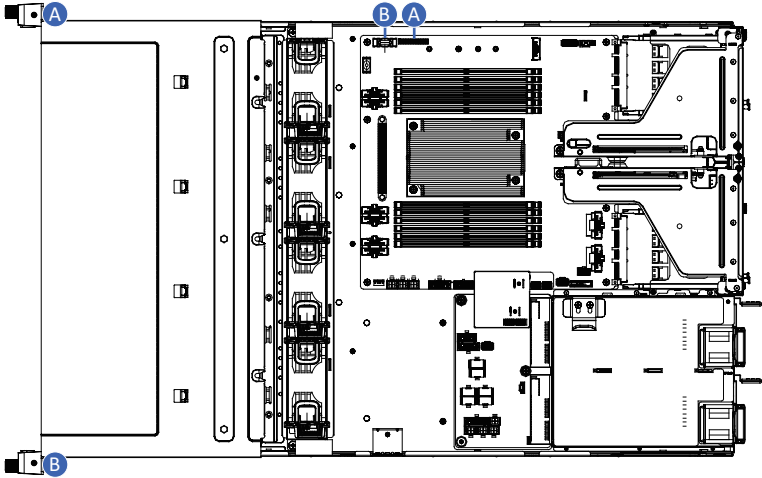

A	Front Switch/LED Cable	Motherboard: FP_1
		--
B	Front USB 3 Cable	Motherboard: F_USB3
		--

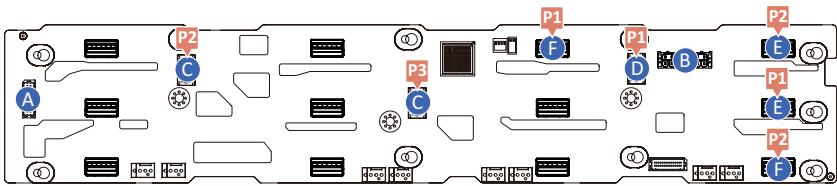
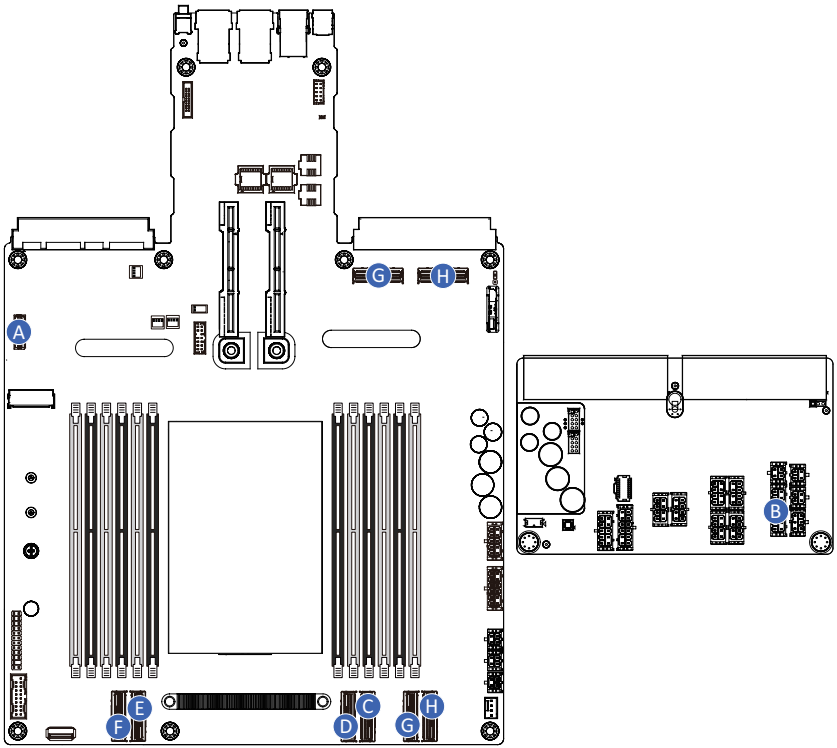

A	Backplane Board Signal Cable	Motherboard: BP_1
		Backplane Board: BP_1
B	Backplane Board Power Cable	Power Board: BP_ATX1
		Backplane Board: ATX1
C	SATA Cable	Motherboard: U2_P0_G3_0
		Backplane Board: SL_SAS0/SL_SAS1
D	SATA Cable	Motherboard: U2_P0_G3_1
		Backplane Board: SL_SAS2
E	NVMe Cable	Motherboard: U2_P0_G0_1
		Backplane Board: U_2_10/ U_2_11
F	NVMe Cable	Motherboard: U2_P0_G0_0
		Backplane Board: U_2_8/ U_2_9
G	OCP Cable	Motherboard: U2_P0_G2_0
		Motherboard: P0_OCP2_A
H	OCP Cable	Motherboard: U2_P0_G2_1
		Motherboard: P0_OCP2_B

Chapter 4 Motherboard Components

4-1 Motherboard Components

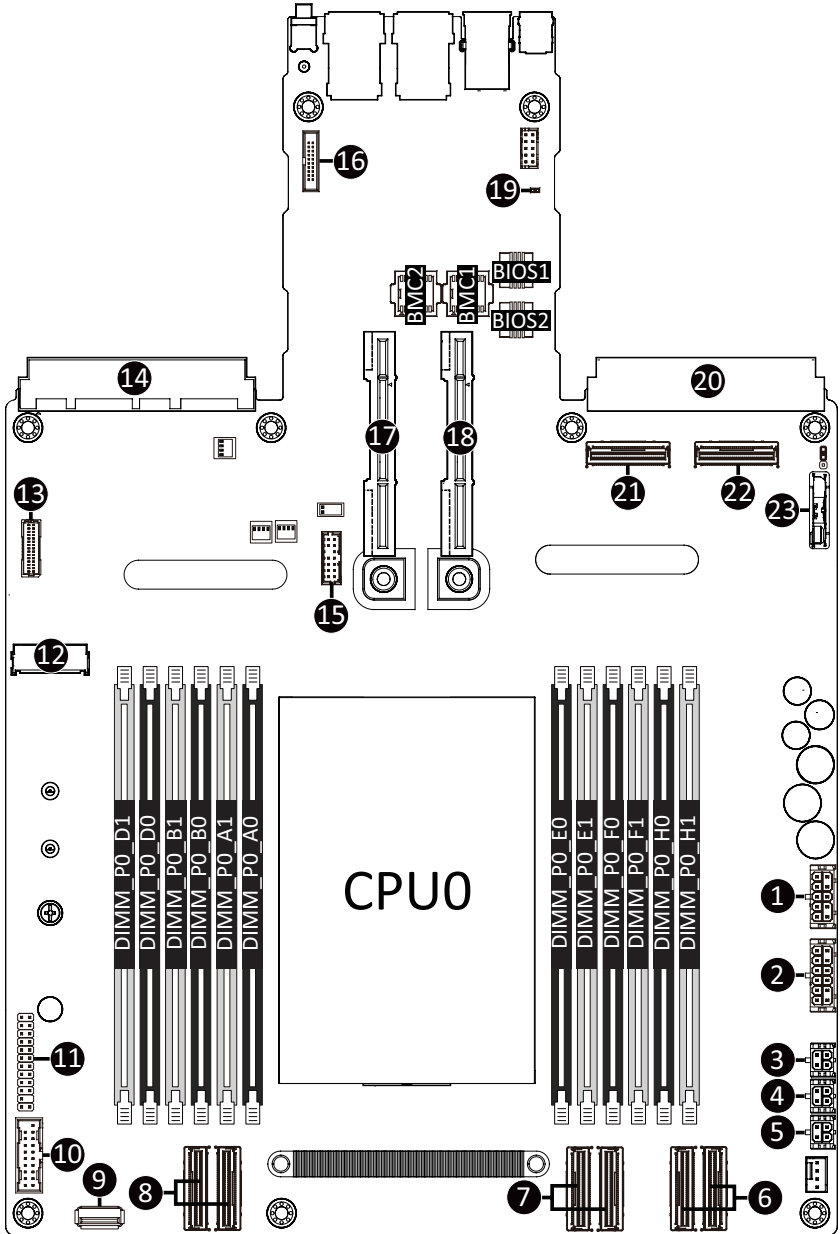

Item	Description
1	2 x 5 Pin ATX Power Connector (MB_ATX2)
2	2 x 6 Pin ATX Power Connector (MB_ATX1)
3	2 x 2 Pin Slot Power Connector (PCIE_PWR3)
4	2 x 2 Pin Slot Power Connector (PCIE_PWR2)
5	2 x 2 Pin Slot Power Connector (PCIE_PWR1)
6	MCIO Connector (U2_P0_G2_0/U2_P0_G2_1)
7	MCIO Connector (U2_P0_G3_0/U2_P0_G3_1)
8	MCIO Connector (U2_P0_G0_0/U2_P0_G0_1)
9	Internal USB 3.0 Type A Connector
10	Front Panel USB 3.2 Gen1 Connector
11	Front Panel Connector
12	M.2 Slot (PCIe Gen3 x4, Support NGFF-22110)
13	HDD Backplane Board Connector
14	OCP 3.0 Connector (PCIe Gen5 x16)
15	TPM Module Connector (SPI Interface)
16	NCSI Connector
17	Riser Connector #1 (PCIe Gen5/x16 Slot)
18	Riser Connector #2 (PCIe Gen5/x16 Slot)
19	BMC Readiness LED
20	OCP 3.0 Connector (PCIe Gen5 x16)
21	MCIO Connector (P0_OCP2_A)
22	MCIO Connector (P0_OCP2_B)
23	System Battery

4-2 Jumper Setting

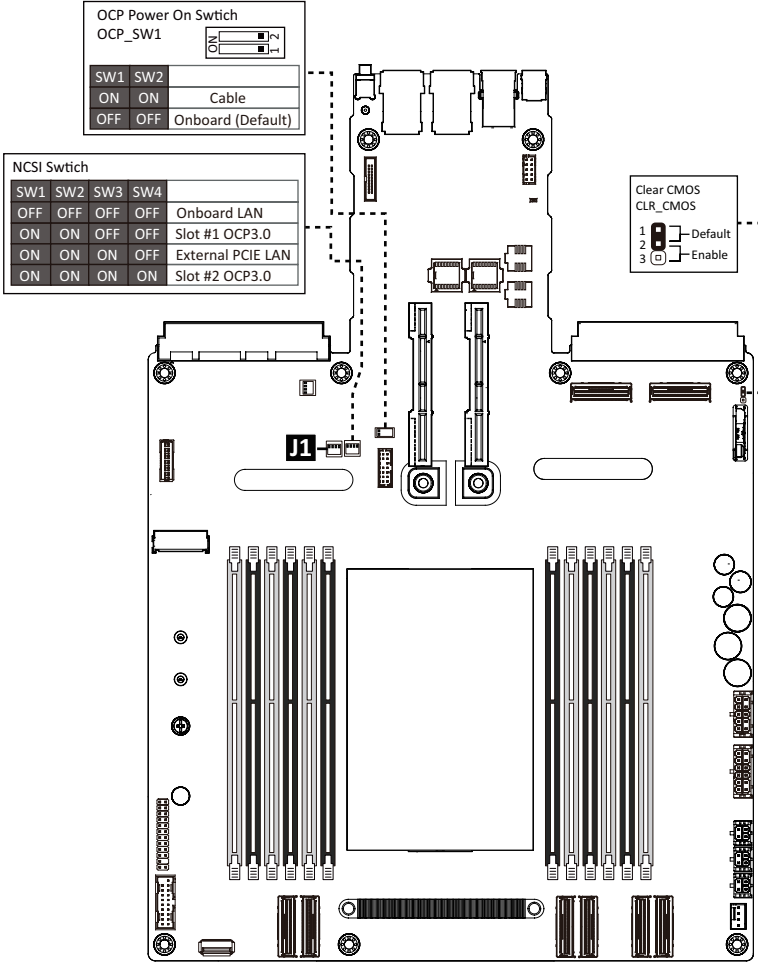

OCP Power On Switch
OCP_SW1

ON	OFF
OFF	ON

SW1	SW2	
ON	ON	Cable
OFF	OFF	Onboard (Default)

NCSI Switch

SW1	SW2	SW3	SW4	
OFF	OFF	OFF	OFF	Onboard LAN
ON	ON	OFF	OFF	Slot #1 OCP3.0
ON	ON	ON	OFF	External PCIE LAN
ON	ON	ON	ON	Slot #2 OCP3.0

Clear CMOS
CLR_CMOS

1	Default
2	Enable
3	Enable

J1	ON	OFF
1	HSMB_SEL	BIOS Defined
2	PMBUS_SEL	BIOS Defined
3	BIOS_PWD_CLEAR	Clear supervisor password Normal [Default]
4	BIOS_RCVR	BIOS recovery mode Normal [Default]

4-3 Backplane Board Storage Connector

4-3-1 CBP20C7

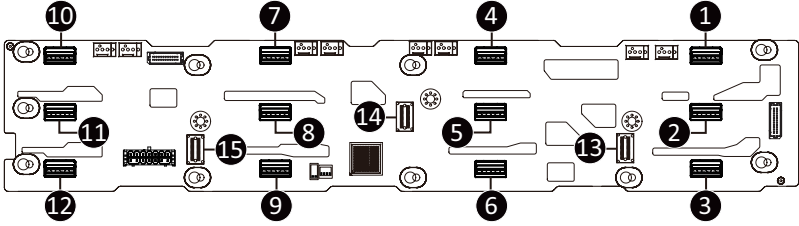

Item	Description
1.	MCIO 4i (SFF-TA-1016 / U.2_0)
2.	MCIO 4i (SFF-TA-1016 / U.2_1)
3.	MCIO 4i (SFF-TA-1016 / U.2_2)
4.	MCIO 4i (SFF-TA-1016 / U.2_3)
5.	MCIO 4i (SFF-TA-1016 / U.2_4)
6.	MCIO 4i (SFF-TA-1016 / U.2_5)
7.	MCIO 4i (SFF-TA-1016 / U.2_6)
8.	MCIO 4i (SFF-TA-1016 / U.2_7)
9.	MCIO 4i (SFF-TA-1016 / U.2_8)
10.	MCIO 4i (SFF-TA-1016 / U.2_9)
11.	MCIO 4i (SFF-TA-1016 / U.2_10)
12.	MCIO 4i (SFF-TA-1016 / U.2_11)
13.	SlimSAS 4i Connector (SFF-8654 / SL_SAS0)
14.	SlimSAS 4i Connector (SFF-8654 / SL_SAS1)
15.	SlimSAS 4i Connector (SFF-8654 / SL_SAS2)

Chapter 2 BIOS Setup

BIOS (Basic Input and Output System) records hardware parameters of the system in the EFI on the motherboard. Its major functions include conducting the Power-On Self-Test (POST) during system startup, saving system parameters, loading the operating system etc. The BIOS includes a BIOS Setup program that allows the user to modify basic system configuration settings or to activate certain system features. When the power is turned off, the battery on the motherboard supplies the necessary power to the CMOS to keep the configuration values in the CMOS.

To access the BIOS Setup program, press the key during the POST when the power is turned on.



- BIOS flashing is potentially risky, if you do not encounter any problems when using the current BIOS version, it is recommended that you don't flash the BIOS. To flash the BIOS, do it with caution. Inadequate BIOS flashing may result in system malfunction.
- It is recommended that you not alter the default settings (unless you need to) to prevent system instability or other unexpected results. Inadequately altering the settings may result in system's failure to boot. If this occurs, try to clear the CMOS values and reset the board to default values. (Refer to the **Exit** section in this chapter or introductions of the battery/clearing CMOS jumper in Chapter 1 for how to clear the CMOS values.)

BIOS Setup Program Function Keys

<<-><->>	Move the selection bar to select the screen
<↑><↓>	Move the selection bar to select an item
<+>	Increase the numeric value or make changes
<->	Decrease the numeric value or make changes
<Enter>	Execute command or enter the submenu
<Esc>	Main Menu: Exit the BIOS Setup program Submenus: Exit current submenu
<F1>	Show descriptions of general help
<F3>	Restore the previous BIOS settings for the current submenus
<F9>	Load the Optimized BIOS default settings for the current submenus
<F10>	Save all the changes and exit the BIOS Setup program

■ **Main**

This setup page includes all the items of the standard compatible BIOS.

■ **Advanced**

This setup page includes all the items of AMI BIOS special enhanced features.

(ex: Auto detect fan and temperature status, automatically configure hard disk parameters.)

■ **AMD CBS**

This setup page includes the common items for configuration of AMD motherboard-related information.

■ **AMD PBS Option**

This setup page includes the common items for configuration of AMD CPM RAS related settings.

■ **Chipset**

This setup page includes all the submenu options for configuring the functions of the North Bridge.

■ **Server Management**

Server additional features enabled/disabled setup menus.

■ **Security**

Change, set, or disable supervisor and user password. Configuration supervisor password allows you to restrict access to the system and BIOS Setup.

A supervisor password allows you to make changes in BIOS Setup.

A user password only allows you to view the BIOS settings but not to make changes.

■ **Boot**

This setup page provides items for configuration of the boot sequence.

■ **Save & Exit**

Save all the changes made in the BIOS Setup program to the CMOS and exit BIOS Setup. (Pressing <F10> can also carry out this task.)

Abandon all changes and the previous settings remain in effect. Pressing <Y> to the confirmation message will exit BIOS Setup. (Pressing <Esc> can also carry out this task.)

2-1 The Main Menu

Once you enter the BIOS Setup program, the Main Menu (as shown below) appears on the screen. Use arrow keys to move among the items and press <Enter> to accept or enter other sub-menu.

Main Menu Help

The on-screen description of a highlighted setup option is displayed on the bottom line of the Main Menu.

Submenu Help

While in a submenu, press <F1> to display a help screen (General Help) of function keys available for the menu. Press <Esc> to exit the help screen. Help for each item is in the Item Help block on the right side of the submenu.



- When the system is not stable as usual, select the **Restore Defaults** item to set your system to its defaults.
- The BIOS Setup menus described in this chapter are for reference only and may differ by BIOS version.

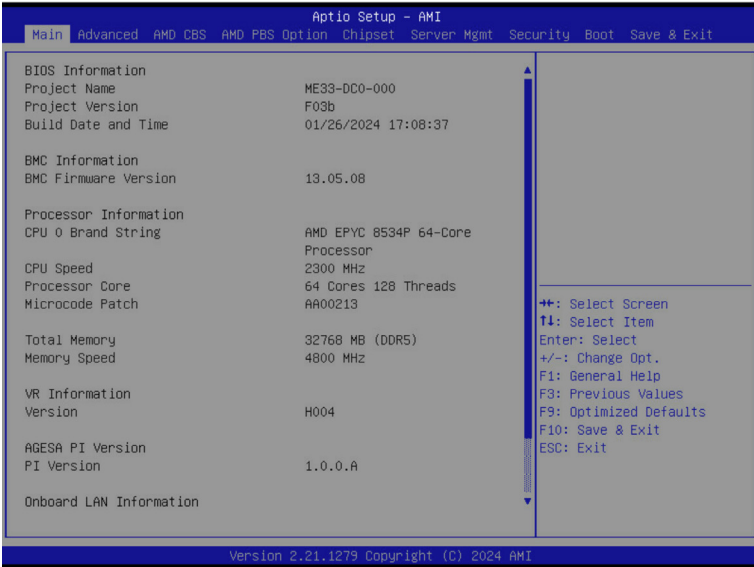

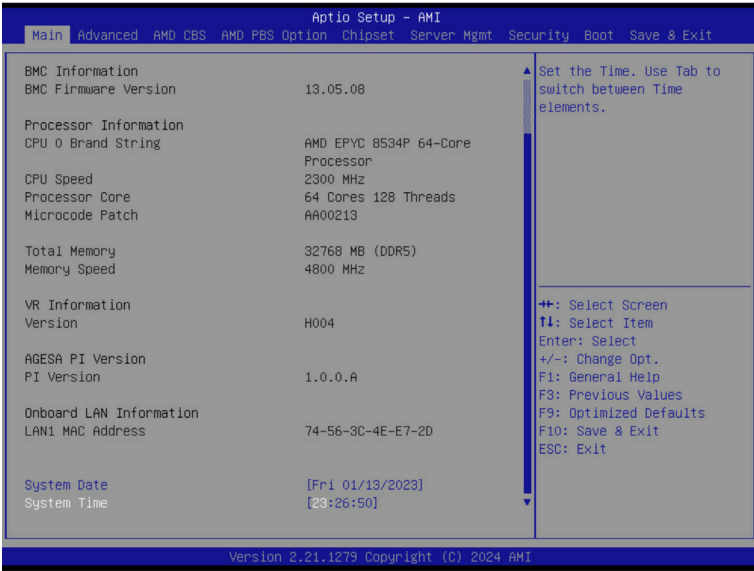

Parameter	Description
BIOS Information	
Project Name	Displays the project name information.
Project Version	Displays version number of the BIOS setup utility.
Build Date and Time	Displays the date and time when the BIOS setup utility was created.
BMC Information ^(Note1)	
BMC Firmware Version ^(Note1)	Displays BMC firmware version information.
Processor Information	
CPU Brand String / CPU Speed / Processor Core / Microcode Patch	Displays the technical specifications for the installed processor(s).
Total Memory ^(Note2)	Displays the total memory size of the installed memory.
Memory Speed ^(Note2)	Displays the frequency information of the installed memory.
VR Information Version	Displays VR version information.
AGESA PI Version	
PI Version	Displays AGESA PI version information.

(Note1) Functions available on selected models.

(Note2) This section will display capacity and frequency information of the memory that the customer has installed.

Parameter	Description
Onboard LAN Information	
LAN1 MAC Address ^(Note)	Displays LAN MAC address information.
System Date	Sets the date following the weekday-month-day-year format.
System Time	Sets the system time following the hour-minute-second format.

(Note) The number of LAN ports listed will depend on the motherboard / system model.

2-2 Advanced Menu

The Advanced Menu displays submenu options for configuring the function of various hardware components. Select a submenu item, then press <Enter> to access the related submenu screen.

When Boot Mode Select is set to UEFI (Default)

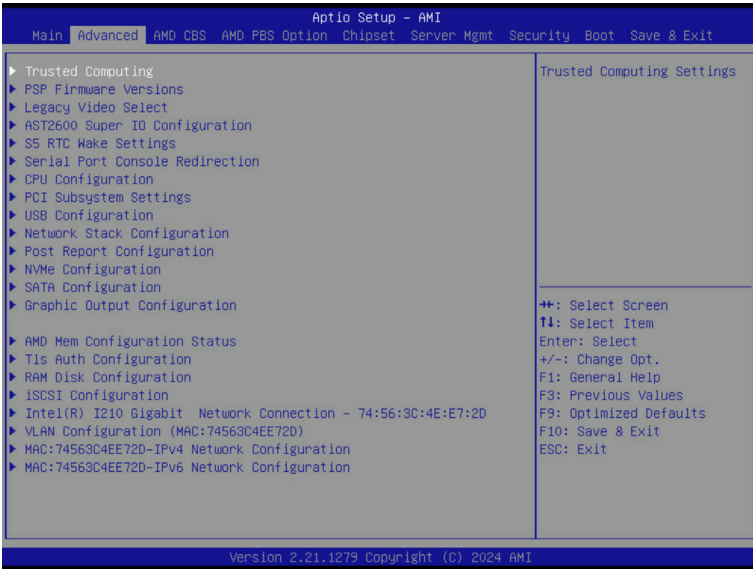

When "Boot Mode Select" is set to Legacy in the Boot > Boot Mode Select section

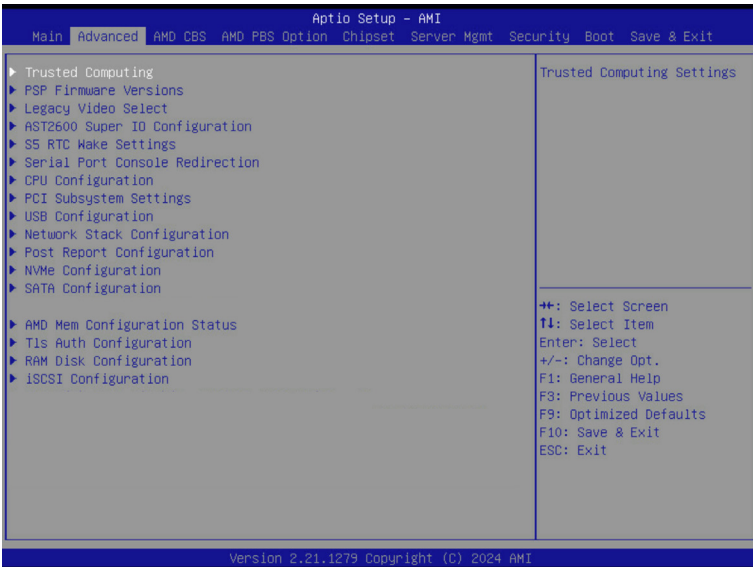

2-2-1 Trusted Computing

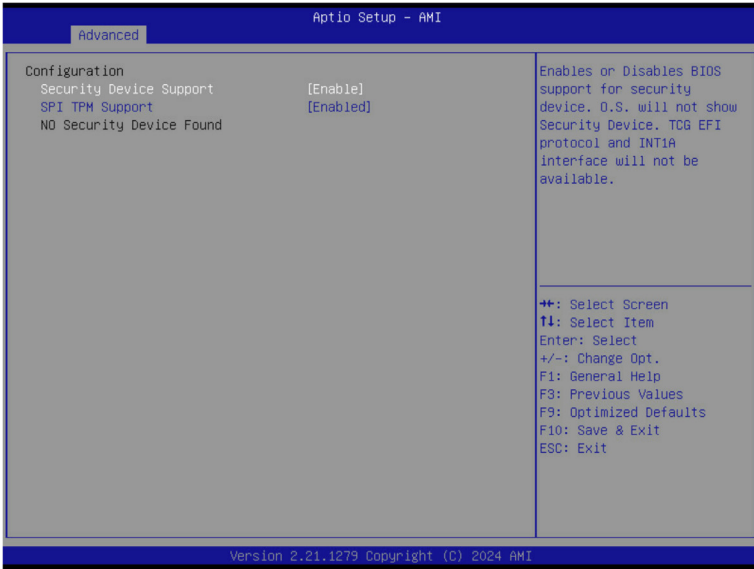

Parameter	Description
Configuration	
Security Device Support	<p>Enable/Disable BIOS support for security device. OS will not show security device. TCG EFI protocol and INT1A interface will not be available.</p> <p>Options available: Disable, Enable. Default setting is Enable.</p>
SPI TPM Support	<p>Select Enable to activate TPM support feature.</p> <p>Options available: Disabled, Enabled. Default setting is Enabled.</p>

2-2-2 PSP Firmware Versions

The PSP Firmware Versions page displays the basic PSP firmware version information. Items on this window are non-configurable.

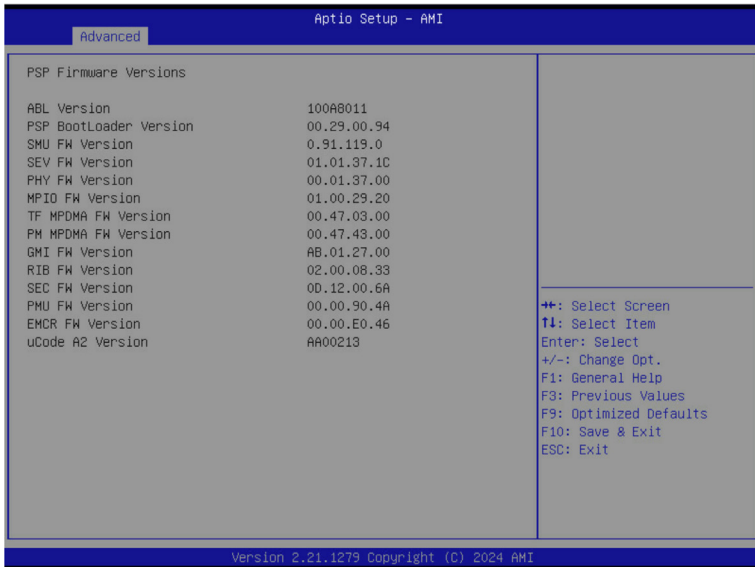

2-2-3 Legacy Video Select

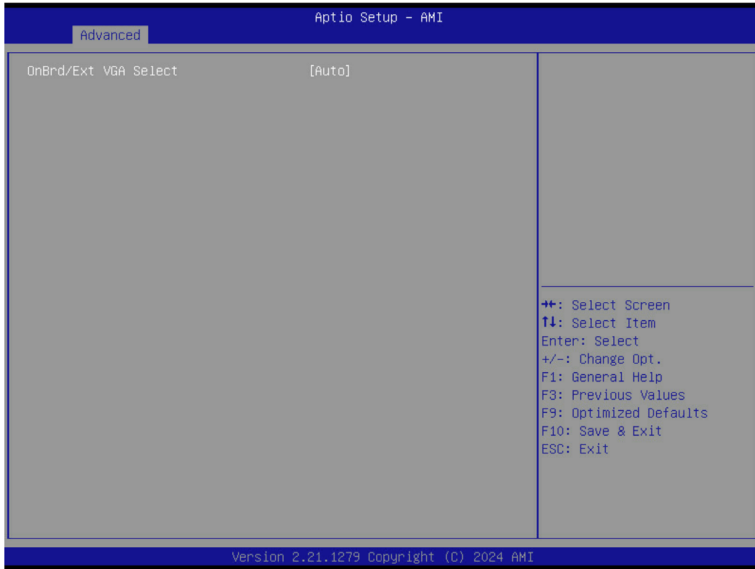

Parameter	Description
OnBrd/Ext VGA Select	Selects between onboard or external VGA support. Options available: Auto, Onboard, External. Default setting is Auto .

(Note) This configurable option will be displayed when "Boot Mode Select" is set to **Legacy** in the **Boot > Boot Mode Select** section.

2-2-4 AST2600 Super IO Configuration

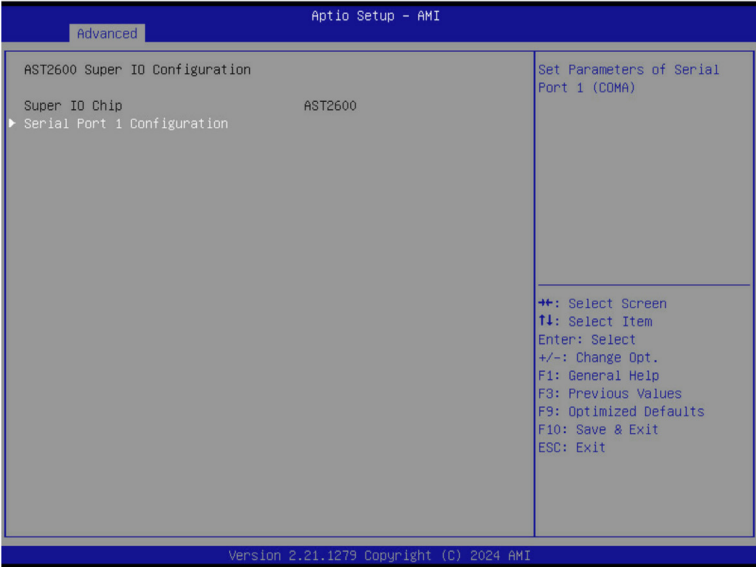

Parameter	Description
AST2600 Super IO Configuration	
Super IO Chip	Displays the super IO chip information
Serial Port 1 Configuration	Press [Enter] for configuration of advanced items.

2-2-4-1 Serial Port 1 Configuration

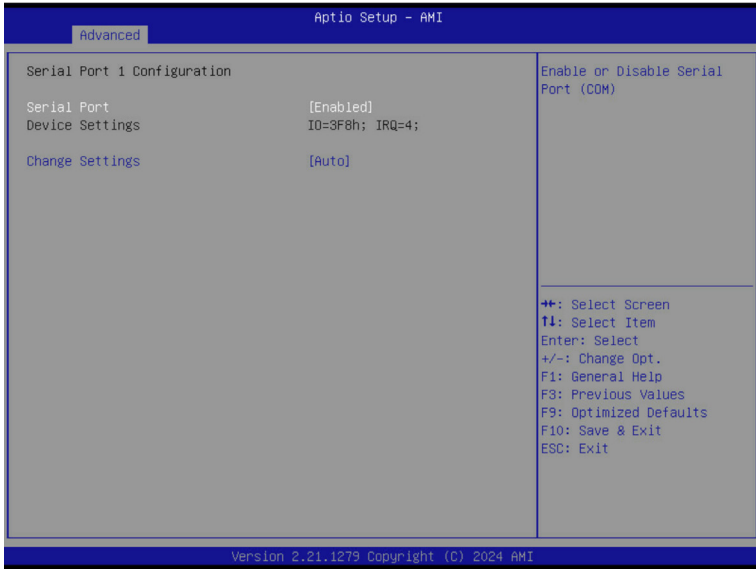

Parameter	Description
Serial Port 1 Configuration	
Serial Port ^(Note)	Enable/Disable the Serial Port (COM). When set to Enabled allows you to configure the Serial port 1 settings. When set to Disabled, displays no configuration for the serial port. Options available: Disabled, Enabled. Default setting is Enabled .
Devices Settings	Displays the Serial Port 1 device settings.
Change Settings	Select an optimal settings for Super IO Device. Options available for Serial Port 1: Auto IO=3F8h; IRQ=4; IO=3F8h; IRQ=3, 4, 5, 6, 7, 9, 10, 11, 12; IO=2F8h; IRQ=3, 4, 5, 6, 7, 9, 10, 11, 12; IO=3E8h; IRQ=3, 4, 5, 6, 7, 9, 10, 11, 12; IO=2E8h; IRQ=3, 4, 5, 6, 7, 9, 10, 11, 12; Default setting is Auto .

(Note) Advanced items prompt when this item is defined.

2-2-5 S5 RTC Wake Settings



Parameter	Description
Wake System from S5	Enable/Disable system wake on alarm event. Options available: Disabled, Fixed Time, Dynamic Time. When Fixed Time is selected, system will wake on the hr::min::sec specified. Default setting is Disabled .

2-2-6 Serial Port Console Redirection

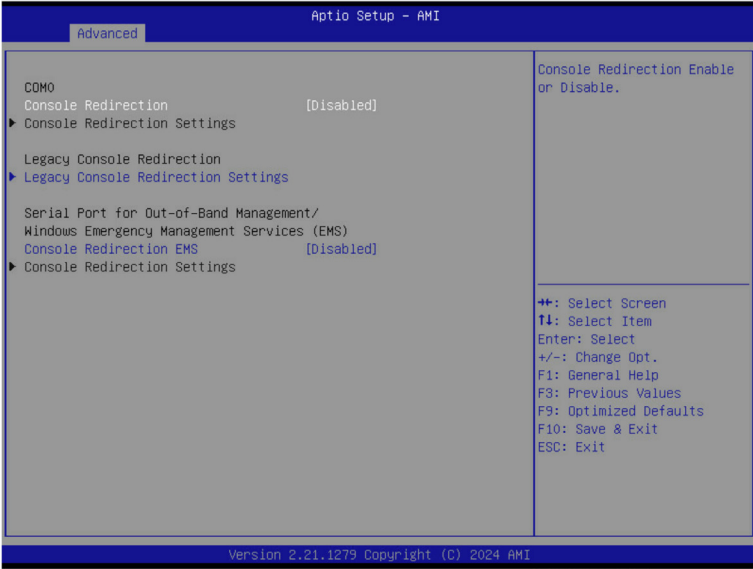

Parameter	Description
COM0 Console Redirection ^(Note)	<p>Select whether to enable console redirection for specified device. Console redirection enables the users to manage the system from a remote location.</p> <p>Options available: Enabled, Disabled. Default setting is Disabled.</p>
COM0 Console Redirection Settings	<p>Press [Enter] to configure advanced items.</p> <p>Please note that this item is configurable when COM0 Console Redirection is set to Enabled.</p> <ul style="list-style-type: none"> ◆ Terminal Type <ul style="list-style-type: none"> – Selects a terminal type to be used for console redirection. – Options available: VT100, VT100Plus, ANSI, VT-UTF8. Default setting is ANSI. ◆ Bits per second <ul style="list-style-type: none"> – Selects the transfer rate for console redirection. – Options available: 9600, 19200, 38400, 57600, 115200. Default setting is 115200. ◆ Data Bits <ul style="list-style-type: none"> – Selects the number of data bits used for console redirection. – Options available: 7, 8. Default setting is 8.

(Note) Advanced items prompt when this item is defined.

Parameter	Description
COM0 Console Redirection Settings (continued)	<ul style="list-style-type: none"> ◆ Parity <ul style="list-style-type: none"> – A parity bit can be sent with the data bits to detect some transmission errors. – Even: parity bit is 0 if the num of 1's in the data bits is even. – Odd: parity bit is 0 if num of 1's in the data bits is odd. – Mark: parity bit is always 1. Space: Parity bit is always 0. – Mark and Space Parity do not allow for error detection. – Options available: None, Even, Odd, Mark, Space. Default setting is None. ◆ Stop Bits <ul style="list-style-type: none"> – Stop bits indicate the end of a serial data packet. (A start bit indicates the beginning). The standard setting is 1 stop bit. Communication with slow devices may require more than 1 stop bit. – Options available: 1, 2. Default setting is 1. ◆ Flow Control <ul style="list-style-type: none"> – Flow control can prevent data loss from buffer overflow. When sending data, if the receiving buffers are full, a 'stop' signal can be sent to stop the data flow. Once the buffers are empty, a 'start' signal can be sent to re-start the flow. Hardware flow control uses two wires to send start/stop signals. – Options available: None, Hardware RTS/CTS. Default setting is None. ◆ VT-UTF8 Combo Key Support <ul style="list-style-type: none"> – Enable/Disable the VT-UTF8 Combo Key Support. – Options available: Enabled, Disabled. Default setting is Enabled. ◆ Recorder Mode <ul style="list-style-type: none"> – When this mode enabled, only texts will be send. This is to capture Terminal data. – Options available: Enabled, Disabled. Default setting is Disabled. ◆ Resolution 100x31 <ul style="list-style-type: none"> – Enable/Disable extended terminal resolution. – Options available: Enabled, Disabled. Default setting is Enabled. ◆ Putty Keypad <ul style="list-style-type: none"> – Selects Function Key and Keypad on Putty. – Options available: VT100, LINUX, XTERMR6, SC0, ESCN, VT400. Default setting is VT100.

Parameter	Description
Legacy Console Redirection	
Legacy Console Redirection Settings	<p>Press [Enter] to configure advanced items.</p> <ul style="list-style-type: none"> ◆ Redirection COM Port <ul style="list-style-type: none"> – Selects a COM port for Legacy serial redirection. – Default setting is COM0. ◆ Resolution <ul style="list-style-type: none"> – Selects the number of rows and columns used in Console Redirection for legacy OS support. – Options available: 80x24, 80x25. Default setting is 80x24. ◆ Redirect After POST <ul style="list-style-type: none"> – When Bootloader is selected, then Legacy Console Redirection is disabled before booting to legacy OS. When Always Enable is selected, then Legacy Console Redirection is enabled for legacy OS. – Options available: Always Enable, BootLoader. Default setting is Always Enable.
Serial Port for Out-of-Band Management / Windows Emergency Management Services (EMS) Console Redirection ^(Note)	<p>EMS console redirection allows the user to configure Console Redirection Settings to support Out-of-Band Serial Port management.</p> <p>Options available: Disabled, Enabled. Default setting is Disabled.</p>
Serial Port for Out-of-Band EMS Console Redirection Settings	<p>Press [Enter] to configure advanced items.</p> <p>Please note that this item is configurable when Serial Port for Out-of-Band Management EMS Console Redirection is set to Enabled.</p> <ul style="list-style-type: none"> ◆ Out-of-Band Mgmt Port <ul style="list-style-type: none"> – Microsoft Windows Emergency Management Service (EMS) allows for remote management of a Windows Server OS through a serial port. – Default setting is COM0. ◆ Terminal Type <ul style="list-style-type: none"> – Selects a terminal type to be used for console redirection. – Options available: VT100, VT100Plus, ANSI, VT-UTF8. Default setting is ANSI. ◆ Bits per second <ul style="list-style-type: none"> – Selects the transfer rate for console redirection. – Options available: 9600, 19200, 57600, 115200. Default setting is 115200.

(Note) Advanced items prompt when this item is defined.

Parameter	Description
Serial Port for Out-of-Band EMS Console Redirection Settings(continued)	<ul style="list-style-type: none">◆ Flow Control<ul style="list-style-type: none">– Flow control can prevent data loss from buffer overflow. When sending data, if the receiving buffers are full, a 'stop' signal can be sent to stop the data flow. Once the buffers are empty, a 'start' signal can be sent to re-start the flow. Hardware flow control uses two wires to send start/stop signals.– Options available: None, Hardware RTS/CTS, Software Xon/Xoff. Default setting is None.

2-2-7 CPU Configuration

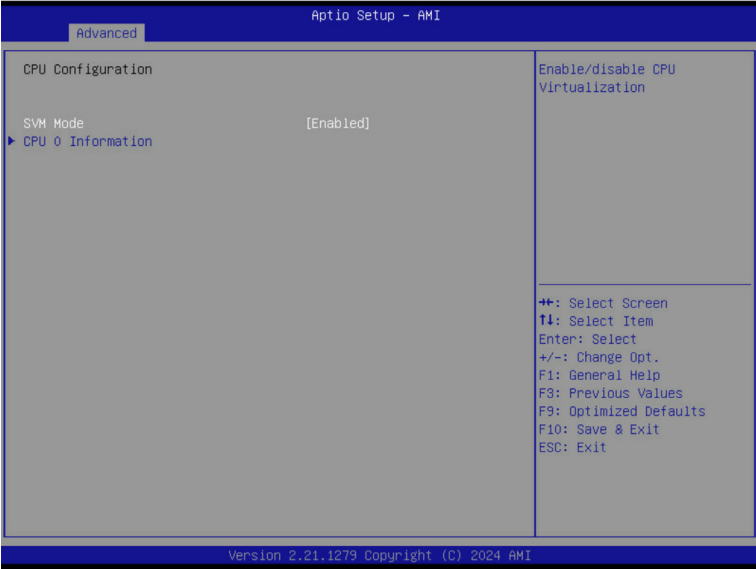

Parameter	Description
SVM Mode	Enable/Disable the CPU Virtualization. Options available: Disabled, Enabled. Default setting is Enabled .
CPU 0 Information	Press [Enter] to view the memory information related to CPU 0.

2-2-8 PCI Subsystem Settings

Aptio Setup - AMI

Advanced

PCI Bus Driver Version	A5.01.30	▲ Change OCP1 POP0 PCIe Lanes. ⇄ Select Screen T4: Select Item Enter: Select +/-: Change Opt. F1: General Help F3: Previous Values F9: Optimized Defaults F10: Save & Exit ESC: Exit
OCP1 POP0	[Auto]	
OCP1 POP0 I/O ROM	[Enabled]	
OCP1 POP0 Link Speed	[Auto]	
MCIO POP0	[Auto]	
MCIO POP0 I/O ROM	[Enabled]	
MCIO POP0 Link Speed	[Auto]	
Slot1	[Auto]	
Slot1 I/O ROM	[Enabled]	
Slot1 Link Speed	[Auto]	
MCIO POP2	[Auto]	⇄ Select Screen T4: Select Item Enter: Select +/-: Change Opt. F1: General Help F3: Previous Values F9: Optimized Defaults F10: Save & Exit ESC: Exit
MCIO POP2 I/O ROM	[Enabled]	
MCIO POP2 Link Speed	[Auto]	
Slot2	[Auto]	
Slot2 I/O ROM	[Enabled]	
Slot2 Link Speed	[Auto]	
MCIO POP3	[Auto]	
MCIO POP3 I/O ROM	[Enabled]	
MCIO POP3 Link Speed	[Auto]	

Version 2.21.1279 Copyright (C) 2024 AMI

Aptio Setup - AMI

Advanced

MCIO POP0 Link Speed	[Auto]	▲ Enables or Disables PCI Express Device Relaxed Ordering. ⇄ Select Screen T4: Select Item Enter: Select +/-: Change Opt. F1: General Help F3: Previous Values F9: Optimized Defaults F10: Save & Exit ESC: Exit
Slot1	[Auto]	
Slot1 I/O ROM	[Enabled]	
Slot1 Link Speed	[Auto]	
MCIO POP2	[Auto]	
MCIO POP2 I/O ROM	[Enabled]	
MCIO POP2 Link Speed	[Auto]	
Slot2	[Auto]	
Slot2 I/O ROM	[Enabled]	
Slot2 Link Speed	[Auto]	
MCIO POP3	[Auto]	⇄ Select Screen T4: Select Item Enter: Select +/-: Change Opt. F1: General Help F3: Previous Values F9: Optimized Defaults F10: Save & Exit ESC: Exit
MCIO POP3 I/O ROM	[Enabled]	
MCIO POP3 Link Speed	[Auto]	
Onboard LAN Controller	[Enabled]	
Onboard LAN1 I/O ROM	[Enabled]	
PCI Devices Common Settings:		
Above 4G Decoding	[Enabled]	
SR-IOV Support	[Enabled]	
Relaxed Ordering	[Enabled]	

Version 2.21.1279 Copyright (C) 2024 AMI

Parameter	Description
PCI Bus Driver Version	Displays the PCI Bus Driver version information.
OC P0P0 ^(Note1)	Change the PCIe lanes.
MCIO P0G# ^(Note2) SLOT# ^(Note3)	Options available: Disabled, Auto, x16, x8x8, x8x4x4, x4x4x8, x4x4x4x4. Default setting is Auto .
MCIO P0G3 ^(Note2)	Change MCIO PCIe lanes. Options available: Disabled, Auto, SATA, x16, x8x8, x8x4x4, x4x4x8, x4x4x4x4. Default setting is Auto .
OC P0P0 I/O ROM ^(Note1) MCIO P0G# I/O ROM ^(Note2) SLOT# I/O ROM ^(Note3)	When enabled, this setting will initialize the device expansion ROM for the related PCI-E slot. Options available: Disabled, Enabled. Default setting is Enabled .
OC P0P0 Link Speed ^(Note1) MCIO P0G# Link Speed ^(Note2) SLOT# Link Speed ^(Note3)	Configure PCIe max link speed. Options available: Auto, Gen4, Gen3, Gen2, Gen1. Default setting is Auto .
Onboard LAN Controller ^(Note4)	Enable/Disable the onboard LAN devices. Options available: Disabled, Enabled. Default setting is Enabled .
Onboard LAN# I/O ROM ^(Note4)	Enable/Disable the onboard LAN devices, and initializes device expansion ROM. Options available: Disabled, Enabled. Default setting is Enabled .
PCI Devices Common Settings	
Above 4G Decoding	Enable/Disable memory mapped I/O to 4GB or greater address space (Above 4G Decoding). Options available: Disabled, Enabled. Default setting is Enabled .
SR-IOV Support	If the system has SR-IOV capable PCIe devices, this item Enable/Disable Single Root IO Virtualization Support. Options available: Disabled, Enabled. Default setting is Enabled .
Relaxed Ordering	Enable/Disable PCI express device relaxed ordering. Options available: Disabled, Enabled. Default setting is Enabled .

(Note1) This section is dependent on the available OCP connector.

(Note2) This section is dependent on the available MCIO connector.

(Note3) This section is dependent on the available PCIe slot.

(Note4) This section is dependent on the available LAN controller.

2-2-9 USB Configuration

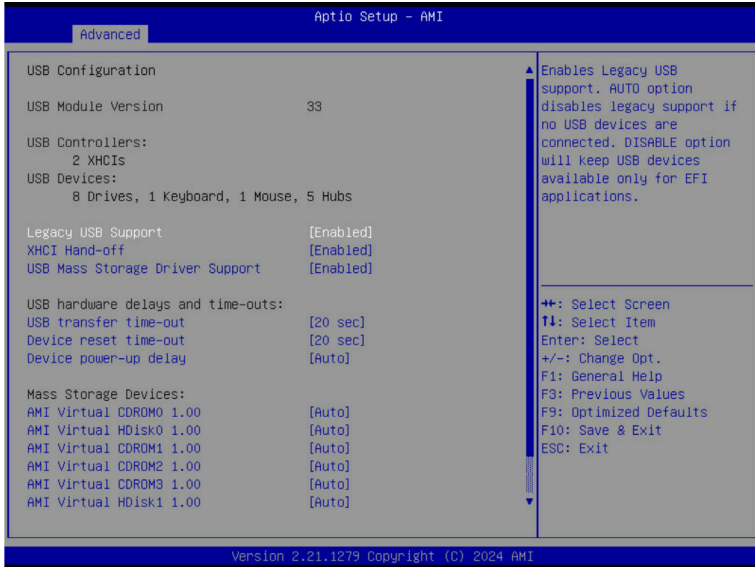

Parameter	Description
USB Configuration	
USB Module Version	Displays the USB module version information.
USB Controllers	Displays the supported USB controllers.
USB Devices:	Displays the USB devices connected to the system.
Legacy USB Support	Enable/Disable the Legacy USB support function. AUTO option disables legacy support if no USB devices are connected. DISABLE option will keep USB devices available only for EFI applications. Options available: Enabled, Disabled, Auto. Default setting is Enabled .
XHCI Hand-off	Enable/Disable the XHCI Hand-off support. Options available: Enabled, Disabled. Default setting is Enabled .
USB Mass Storage Driver Support ^(Note)	Enable/Disable the USB Mass Storage Driver Support. Options available: Disabled, Enabled. Default setting is Enabled .
USB hardware delays and time-outs	
USB transfer time-out	Selects the time-out value for USB Control/Bulk/Interrupt transfers. Options available: 1 sec, 5 sec, 10 sec, 20 sec. Default setting is 20 sec .

(Note) This item is present only if you attach USB devices.

Parameter	Description
Device reset time-out	Selects the time-out value during a USB mass storage device reset. Options available: 10 sec, 20 sec, 30 sec, 40 sec. Default setting is 20 sec .
Device power-up delay	Maximum time the device will take before it properly reports itself to the Host Controller. "Auto" uses default value: for a Root port it is 100 ms, for a Hub port the delay is taken from Hub descriptor. Options available: Auto, Manual. Default setting is Auto .

2-2-10 Network Stack Configuration

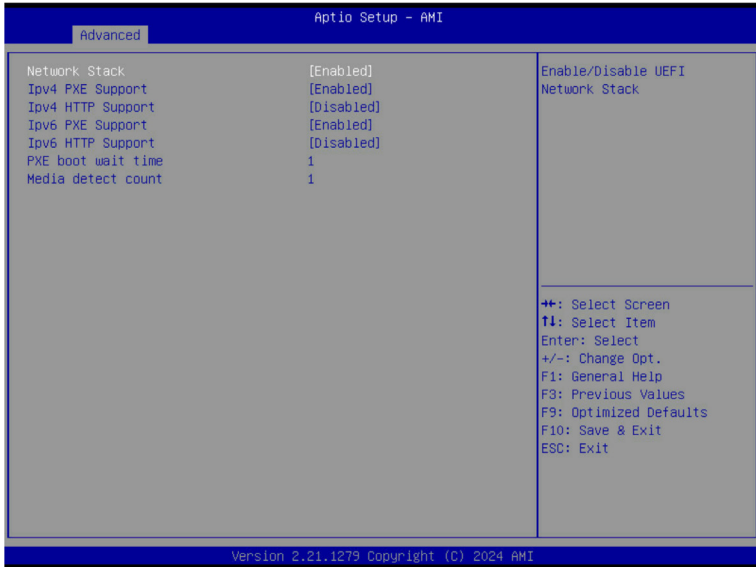

Parameter	Description
Network Stack	Enable/Disable the UEFI network stack. Options available: Enabled, Disabled. Default setting is Enabled .
Ipv4 PXE Support ^(Note)	Enable/Disable the Ipv4 PXE feature. Options available: Enabled, Disabled. Default setting is Enabled .
Ipv4 HTTP Support ^(Note)	Enable/Disable the Ipv4 HTTP feature. Options available: Enabled, Disabled. Default setting is Disabled .
Ipv6 PXE Support ^(Note)	Enable/Disable the Ipv6 PXE feature. Options available: Enabled, Disabled. Default setting is Enabled .
Ipv6 HTTP Support ^(Note)	Enable/Disable the Ipv6 HTTP feature. Options available: Enabled, Disabled. Default setting is Disabled .
PXE boot wait time ^(Note)	Wait time in seconds to press ESC key to abort the PXE boot. Press the <+> / <-> keys to increase or decrease the desired values.
Media detect count ^(Note)	Number of times the presence of media will be checked. Press the <+> / <-> keys to increase or decrease the desired values.

(Note) This item appears when **Network Stack** is set to **Enabled**.

2-2-11 Post Report Configuration

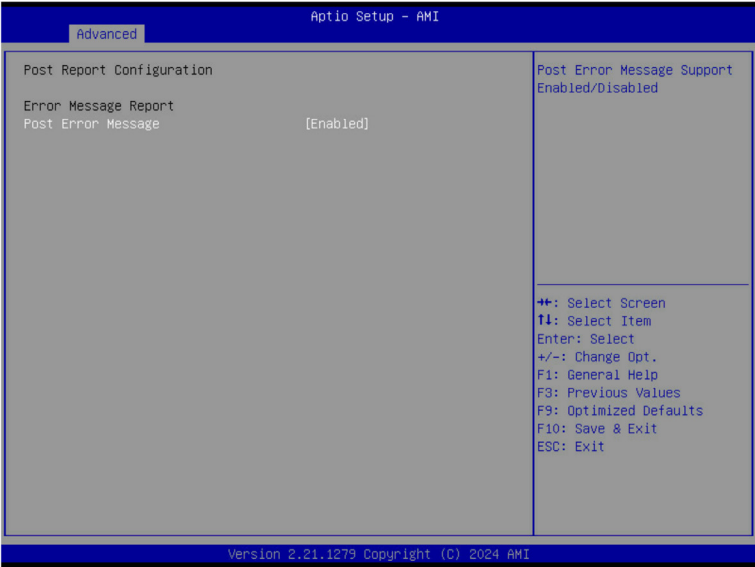

Parameter	Description
Post Report Configuration	
Error Message Report	
Post Error Message	Enable/Disable the POST Error Message support. Options available: Enabled, Disabled. Default setting is Enabled .

2-2-12 NVMe Configuration

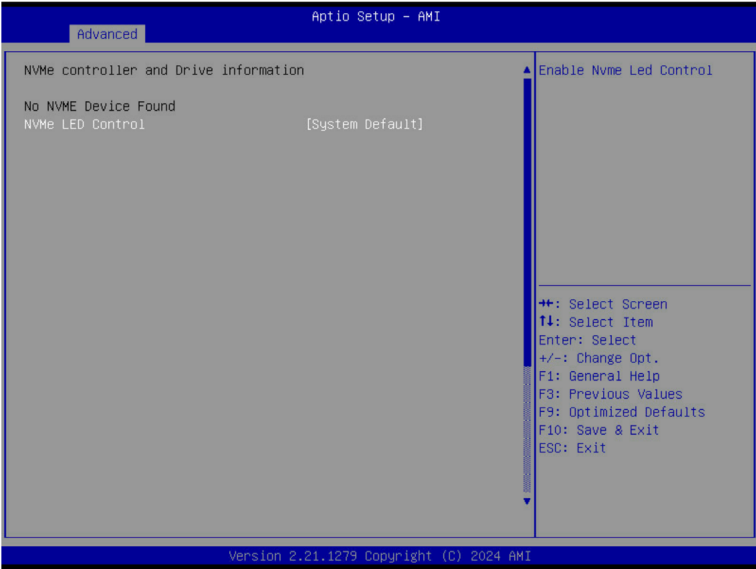

Parameter	Description
NVMe Configuration	Displays the NVMe devices connected to the system.
NVMe LED Control	Enable/Disable NVMe LED Control. Options available: System Default, Disabled, Enabled. Default setting is System Default .

2-2-13 SATA Configuration

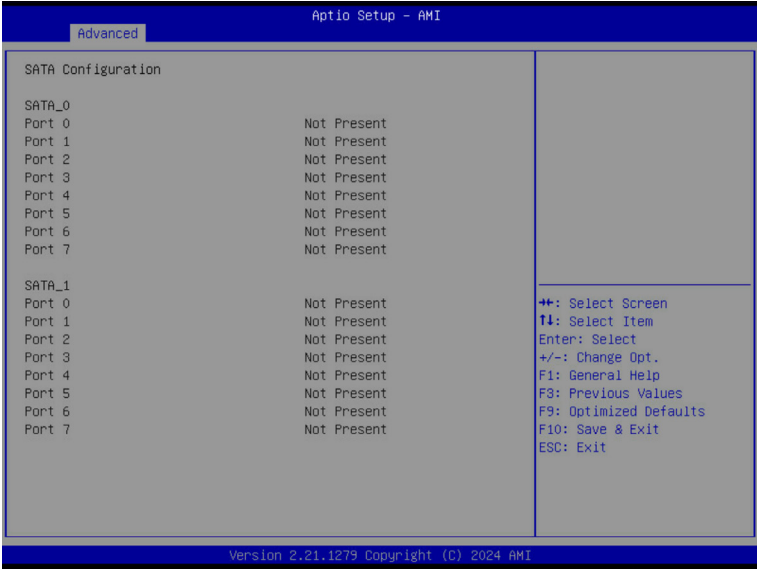

Parameter	Description
SATA Configuration	Displays the installed HDD devices information. System will automatically detect HDD type.

2-2-14 Graphic Output Configuration

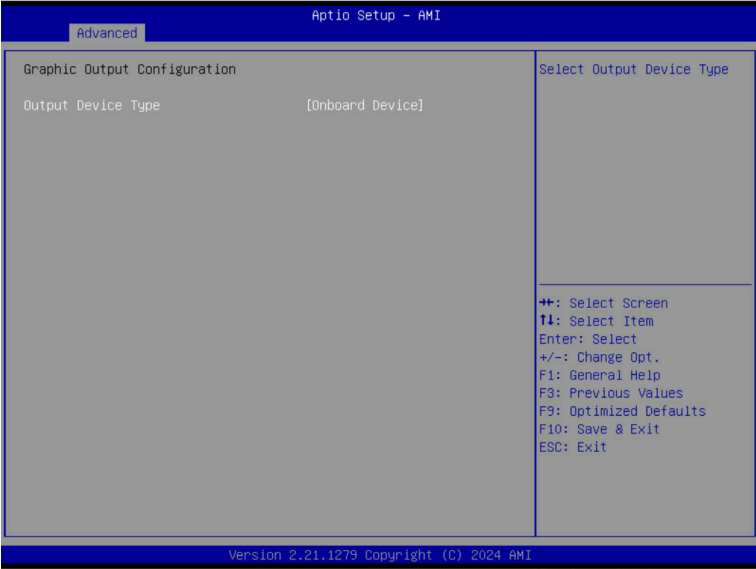

Parameter	Description
Output Device Type	Selects output device type. Options available: First loaded Device, Onboard Device, External Device, Specific Device. Default setting is Onboard Device .

2-2-15 AMD Mem Configuration Status

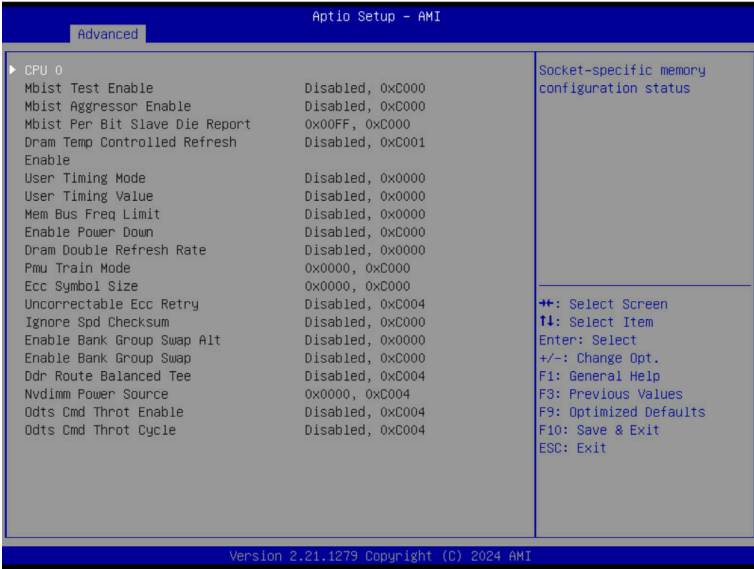

Parameter	Description
CPU 0	Press [Enter] to view the memory configuration status related to CPU 0.

2-2-16 Tls Auth Configuration

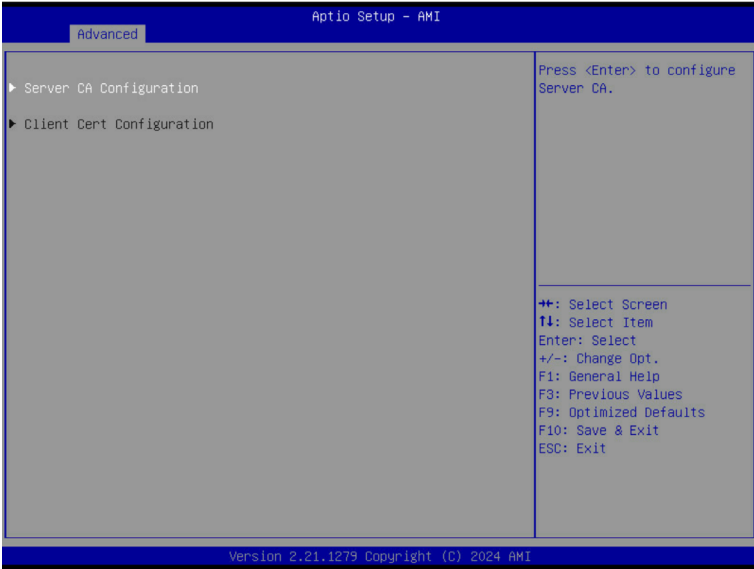

Parameter	Description
Server CA Configuration	<p>Press [Enter] for configuration of advanced items.</p> <ul style="list-style-type: none"> ◆ Enroll Cert <ul style="list-style-type: none"> – Press [Enter] to enroll a certificate <ul style="list-style-type: none"> • Enroll Cert Using File • Cert GUID Input digit character in 1111111-2222-3333-4444-1234567890ab format. – Commit Changes and Exit – Discard Changes and Exit ◆ Delete Cert
Client Cert Configuration	Press [Enter] for configuration of advanced items.

2-2-17 RAM Disk Configuration

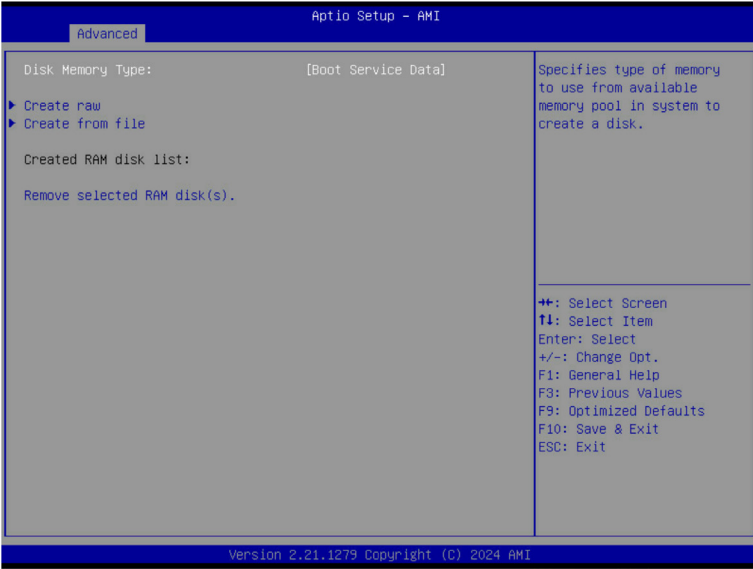

Parameter	Description
Disk Memory Type	Specifies the type of memory to use from available memory pool in system to create a disk. Options available: Boot Service Data, Reserved. Default setting is Boot Service Data .
Create Raw	Creates a raw RAM disk. <ul style="list-style-type: none"> ◆ Size (Hex) <ul style="list-style-type: none"> – Input a valid RAM disk size that should be multiple of the RAM disk block size. ◆ Create & Exit ◆ Discard & Exit
Create from file	Creates a RAM disk from a given file.
Created RAM disk list	
Remove selected RAM disk(s)	Selects the RAM disk(s) to remove.

2-2-18 iSCSI Configuration

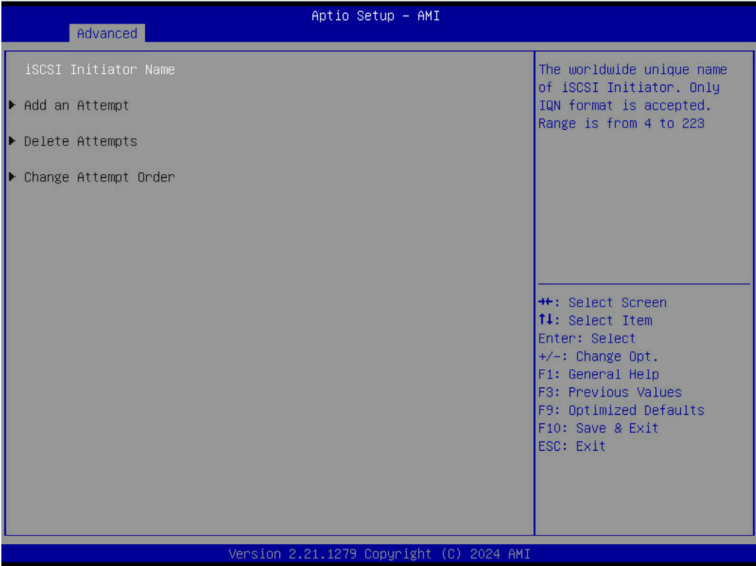

Parameter	Description
iSCSI Initiator Name	Press [Enter] and name iSCSI Initiator. Only IQN format is accepted. Range: from 4 to 223
Add an Attempt	Press [Enter] to configure advanced items.
Delete Attempts	Press [Enter] to configure advanced items.
Change Attempt Order	Press [Enter] to configure advanced items.

2-2-19 Intel(R) I210 Gigabit Network Connection

Advanced		Aptio Setup - AMI	
<p>▶ NIC Configuration</p> <p>Blink LEDs 0</p> <p>UEFI Driver Intel(R) PRO/1000 8.5.21 PCI-E</p> <p>Adapter PBA 211018-008</p> <p>Device Name Intel(R) I210 Gigabit Network Connection</p> <p>Chip Type Intel i210</p> <p>PCI Device ID 1533</p> <p>PCI Address C7:00:00</p> <p>Link Status [Disconnected]</p> <p>MAC Address 74:56:3C:4E:E7:2D</p> <p>Virtual MAC Address 00:00:00:00:00:00</p>		<p>Click to configure the network device port.</p> <hr/> <p> ++: Select Screen ↑↓: Select Item Enter: Select +/-: Change Opt. F1: General Help F3: Previous Values F9: Optimized Defaults F10: Save & Exit ESC: Exit </p>	
Version 2.21.1279 Copyright (C) 2024 AMI			

Advanced		Aptio Setup - AMI	
<p>Link Speed [Auto Negotiated]</p> <p>Wake On LAN [Enabled]</p>		<p>Specifies the port speed used for the selected boot protocol.</p> <hr/> <p> ++: Select Screen ↑↓: Select Item Enter: Select +/-: Change Opt. F1: General Help F3: Previous Values F9: Optimized Defaults F10: Save & Exit ESC: Exit </p>	
Version 2.21.1279 Copyright (C) 2024 AMI			

Parameter	Description
NIC Configuration	<p>Press [Enter] to configure advanced items.</p> <ul style="list-style-type: none"> ◆ Link Speed <ul style="list-style-type: none"> – Allows for automatic link speed adjustment. – Options available: Auto Negotiated, 10 Mbps Half, 10 Mbps Full, 100 Mbps Half, 100 Mbps Full. Default setting is Auto Negotiated. ◆ Wake On LAN <ul style="list-style-type: none"> – Enables power on of the system via LAN. Note that configuring Wake on LAN in the operating system does not change the value of this setting, but does override the behavior of Wake on LAN in OS controlled power states. – Options available: Disabled, Enabled. Default setting is Enabled.
Blink LEDs	<p>Identifies the physical network port by blinking the associated LED. Press the numeric keys to adjust desired values.</p>
UEFI Driver	Displays the technical specifications for the Network Interface Controller.
Adapter PBA	Displays the technical specifications for the Network Interface Controller.
Device Name	Displays the technical specifications for the Network Interface Controller.
Chip Type	Displays the technical specifications for the Network Interface Controller.
PCI Device ID	Displays the technical specifications for the Network Interface Controller.
PCI Address	Displays the technical specifications for the Network Interface Controller.
Link Status	Displays the technical specifications for the Network Interface Controller.
MAC Address	Displays the technical specifications for the Network Interface Controller.
Virtual MAC Address	Displays the technical specifications for the Network Interface Controller.

2-2-20 VLAN Configuration

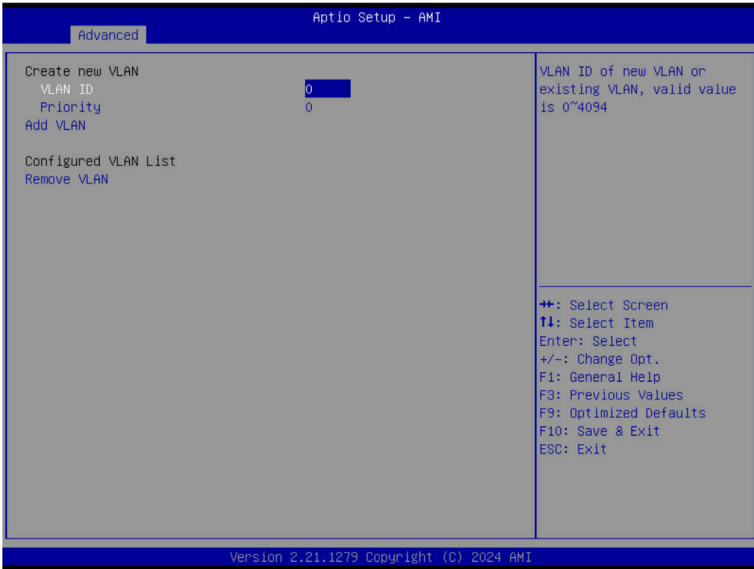

Parameter	Description
Enter Configuration Menu	<p>Press [Enter] to configure advanced items.</p> <ul style="list-style-type: none"> ◆ Create new VLAN ◆ VLAN ID <ul style="list-style-type: none"> – Sets VLAN ID for a new VLAN or an existing VLAN. – Press the <+> / <-> keys to increase or decrease the desired values. – The valid range is from 0 to 4094. ◆ Priority <ul style="list-style-type: none"> – Sets 802.1Q Priority for a new VLAN or an existing VLAN. – Press the <+> / <-> keys to increase or decrease the desired values. – The valid range is from 0 to 7. ◆ Add VLAN <ul style="list-style-type: none"> – Press [Enter] to create a new VLAN or update an existing VLAN. ◆ Configured VLAN List ◆ Remove VLAN <ul style="list-style-type: none"> – Press [Enter] to remove an existing VLAN.

2-2-21 MAC IPv4 Network Configuration

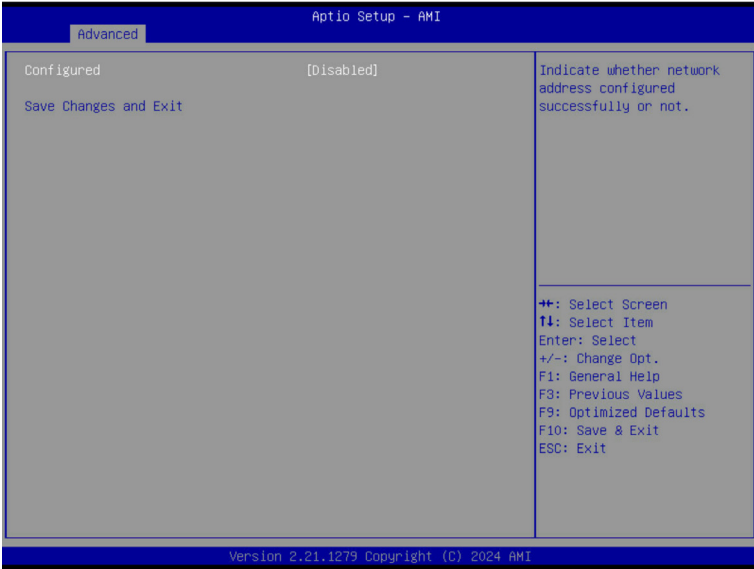

Parameter	Description
Configured	Indicates whether network address is configured successfully or not. Options available: Enabled, Disabled. Default setting is Disabled .
Enable DHCP ^(Note)	Options available: Enabled, Disabled. Default setting is Disabled .
Local IP Address ^(Note)	Press [Enter] to configure local IP address.
Local NetMask ^(Note)	Press [Enter] to configure local NetMask.
Local Gateway ^(Note)	Press [Enter] to configure local Gateway
Local DNS Servers ^(Note)	Press [Enter] to configure local DNS servers
Save Changes and Exit	Press [Enter] to save all configurations.

(Note) This item appears when **Configured** is set to **Enabled**.

2-2-22 MAC IPv6 Network Configuration

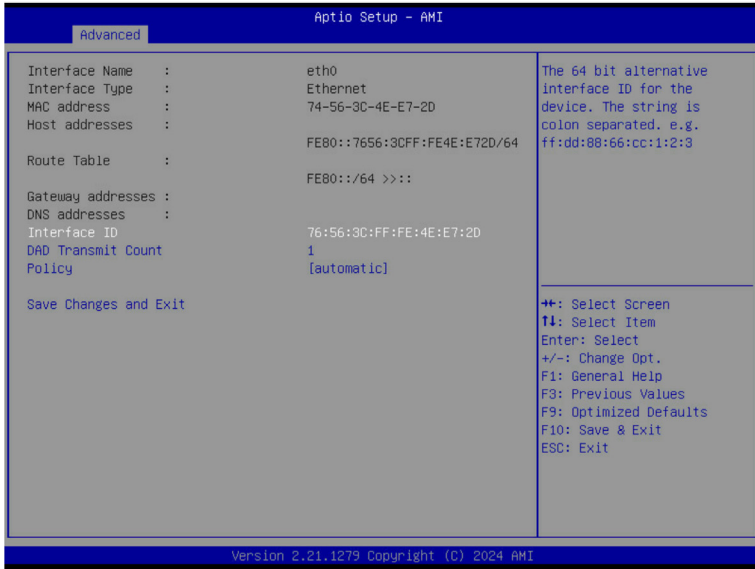

Parameter	Description
Enter Configuration Menu	<p>Press [Enter] to configure advanced items.</p> <ul style="list-style-type: none"> ◆ Displays the MAC Address information. ◆ Interface ID <ul style="list-style-type: none"> – The 64 bit alternative interface ID for the device. The string is colon separated. e.g. ff:dd:88:66:cc:1:2:3. ◆ DAD Transmit Count <ul style="list-style-type: none"> – The number of consecutive Neighbor solicitation messages sent while performing Duplicate Address Detection on a tentative address. A value of zero indicates that Duplicate Address Detection is not performed. ◆ Policy <ul style="list-style-type: none"> – Options available: automatic, manual. Default setting is automatic. ◆ Save Changes and Exit <ul style="list-style-type: none"> – Press [Enter] to save all configurations.

2-3 AMD CBS Menu

AMD CBS menu displays submenu options for configuring the CPU-related information that the BIOS automatically sets. Select a submenu item, then press [Enter] to access the related submenu screen.

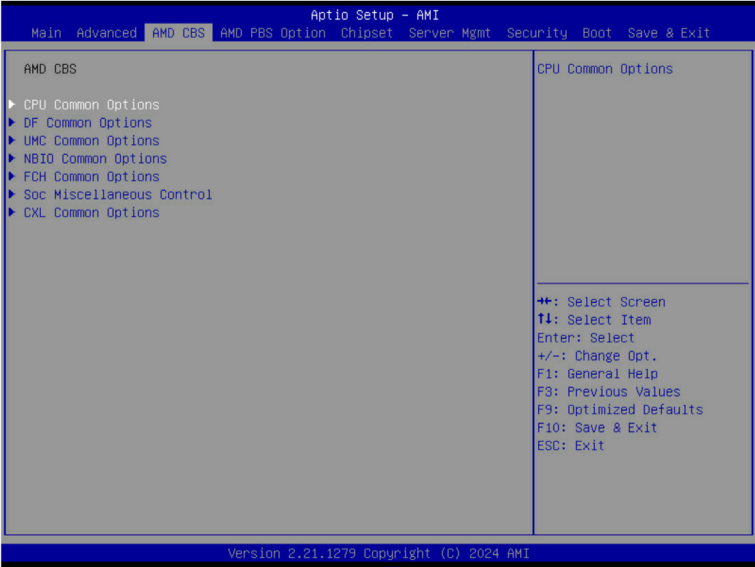

2-3-1 CPU Common Options

AMD CBS Aptio Setup - AMI

CPU Common Options		Performance
▶ Performance		
REP-MOV/STOS Streaming	[Enabled]	
▶ Prefetcher settings		
▶ Core Watchdog		
RedirectForReturnDis	[Auto]	
Platform First Error Handling	[Auto]	
Core Performance Boost	[Auto]	
Global C-state Control	[Auto]	
Power Supply Idle Control	[Auto]	
SEV-ES ASID Space Limit	1	
SEV Control	[Enabled]	
Streaming Stores Control	[Auto]	
Local APIC Mode	[Auto]	
ACPI _CST C1 Declaration	[Auto]	
ACPI CST C2 Latency	800	
MCA error thresh enable	[True]	
MCA error thresh count	0	
MCA FruText	[True]	
SMU and PSP Debug Mode	[Auto]	
PPIN Opt-in	[Auto]	
SNP Memory (RMP Table) Coverage	[Auto]	
SMEE	[Auto]	

⇧: Select Screen
 ⇩: Select Item
 Enter: Select
 +/-: Change Opt.
 F1: General Help
 F3: Previous Values
 F9: Optimized Defaults
 F10: Save & Exit
 ESC: Exit

Version 2.21.1279 Copyright (C) 2024 AMI

AMD CBS Aptio Setup - AMI

Power Supply Idle Control	[Auto]	Enables XI logic which calculates average latency, updates throttle level, and sends throttle level messages to L2
SEV-ES ASID Space Limit	1	
SEV Control	[Enabled]	
Streaming Stores Control	[Auto]	
Local APIC Mode	[Auto]	
ACPI _CST C1 Declaration	[Auto]	
ACPI CST C2 Latency	800	
MCA error thresh enable	[True]	
MCA error thresh count	0	
MCA FruText	[True]	
SMU and PSP Debug Mode	[Auto]	
PPIN Opt-in	[Auto]	
SNP Memory (RMP Table) Coverage	[Auto]	
SMEE	[Auto]	
Action on BIST Failure	[Auto]	
Fast Short REP MOVSB (FSRM)	[Auto]	
Enhanced REP MOVSB/STOSB (ERSM)	[Auto]	
Log Transparent Errors	[Auto]	
AVX512	[Auto]	
MONITOR and MWAIT disable	[Auto]	
Small Hammer Configuration	[Auto]	
Corrector Branch Predictor	[Disabled]	
PAUSE Delay	[Auto]	
CPU Speculative Store Modes	[Auto]	
Prefetch/Request Throttle	[Auto]	

⇧: Select Screen
 ⇩: Select Item
 Enter: Select
 +/-: Change Opt.
 F1: General Help
 F3: Previous Values
 F9: Optimized Defaults
 F10: Save & Exit
 ESC: Exit

Version 2.21.1279 Copyright (C) 2024 AMI

Parameter	Description
CPU Common Options	
Performance	Press [Enter] for configuration of advanced items.
REP-MOV/STOS Streaming	Allow REP-MOV/STOS to use non-caching streaming stores for large sizes. Options available: Disabled, Enabled. Default setting is Enabled .
Prefetcher settings	Press [Enter] for configuration of advanced items.
Core Watchdog	Press [Enter] for configuration of advanced items.
RedirectForReturnDis	From a workaround for GCC/C000005 issue for XV Core on CZ A0, setting MSRC001_1029 Decode Configuration (DE_CFG) bit 14 [DecfgNoRdrctForReturns] to 1. Options available: Auto, 1, 0. Default setting is Auto .
Platform First Error Handling	Enable/Disable PFEH, cloak individual banks, and mask deferred error interrupts from each bank. Options available: Enabled, Disabled, Auto. Default setting is Auto .
Core Performance Boost	Enable/Disable the Core Performance Boost function. Options available: Disabled, Auto. Default setting is Auto .
Global C-state Control	Controls the IO based C-state generation and DF C-states. Options available: Disabled, Enabled, Auto. Default setting is Auto .
Power Supply Idle Control	Configures the Power Supply Idle Control. Options available: Low Current Idle, Typical Current Idle, Auto. Default setting is Auto .
SEV-ES ASID Space Limit	Configures the Space limit for SEV-ES ASIDs. Default setting is 1 .
SEV Control	Enable/Disable SEV control. Options available: Enable, Disable. Default setting is Enable .
Streaming Stores Control	Enable/Disable the Streaming Stores functionality. Options available: Disabled, Enabled, Auto. Default setting is Auto .
Local APIC Mode	Sets the Local APIC Mode. Options available: Compatibility, xAPIC, x2APIC, Auto. Default setting is Auto .
ACPI_CST C1 Declaration	Determines whether or not to declare the C1 state to the OS.. Options available: Disabled, Enabled, Auto. Default setting is Auto .
ACPI CST C2 Latency	Enter in microseconds (decimal value).
MCA error thresh enable	Enable MCA error thresholding. Options available: False, True, Auto. Default setting is True .
MCA error thresh count	Effective error threshold count = 0xFFFF(4095) - <this value> (e.g. the default value of 0xFF5(4085) results in a threshold of 0xA (10)).
MCA FruText	Enable MCA FruText. Options available: False, True. Default setting is True .
SMU and PSP Debug Mode	When this option is enabled, specific uncorrected errors detected by the PSP FW or SMU FW will hand and not reset the system. Options available: Disabled, Enabled, Auto. Default setting is Auto .
PPIN Opt-in	Enable/Disable the PPIN feature. Options available: Disabled, Enabled, Auto. Default setting is Auto .

Parameter	Description
SNP Memory (RMP Table) Coverage	Enabled: Enter system memory is covered. Options available: Disabled, Enabled, Custom, Auto. Default setting is Auto .
SMEE	Controls the Secure Memory Encryption Enable (SMEE) function. Options available: Disable, Enable, Auto. Default setting is Auto .
Action on BIST Failure	Action to take when a CCD BIST failure is detected. Options available: Do nothing, Down-CCD, Auto. Default setting is Auto .
Fast Short REP MOVSB (FSRM)	Options available: Disabled, Enabled, Auto. Default setting is Auto .
Enhanced REP MOVSB/STOSB (ERMSB)	Options available: Disabled, Enabled, Auto. Default setting is Auto .
Log Transparent Errors	Enable/Disable the log Transparent errors function. Options available: Auto, Disabled, Enabled. Default setting is Auto .
AVX512	Enable/Disable AVX512. Options available: Disabled, Enabled, Auto. Default setting is Auto .
MONITOR and MWAIT disable	The MONITOR, MWAIT, MONITORX and MWAITX opcodes become invalid when enabled. Options available: Enabled, Disabled, Auto. Default setting is Auto
Small Hammer Configuration	Options available: Disabled, Enabled, Auto. Default setting is Auto .
Corrector Branch Predictor	Options available: Disable, Enable. Default setting is Disable .
PAUSE Delay	Number a cycles thread will be idle after a PAUSE instruction. Options available: Auto, Disable, 16 cycles, 32 cycles, 64 cycles, 128 cycles. Default setting is Auto .
CPU Speculative Store Modes	Select the CPU speculative store modes. Options available: Balanced, More Speculative, Less Speculative, Auto. Default setting is Auto .
Prefetch/Request Throttle	Enables XI logic which calculates average latency, updates throttle level, and sends throttle level messages to L2. Options available: Disable, Enable, Auto. Default setting is Auto .

2-3-1-1 Performance

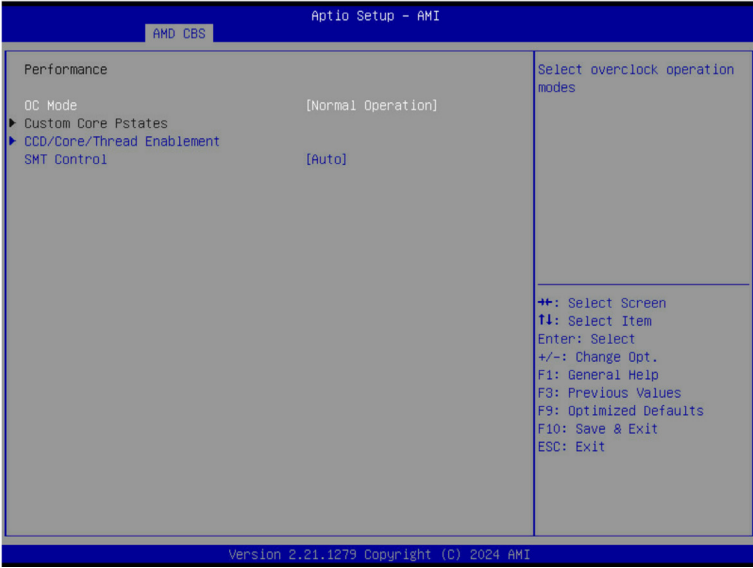

Parameter	Description
Performance	
OC Mode ^(Notes)	Options available: Normal Operation, Customized. Default setting is Normal Operation .
Custom Core Pstates	Allows you to accept or decline enabling Custom Core Pstates. When accepted, you can disable or customize core pstates.
CCD/Core/Thread Enablement	Allows you to accept or decline enabling CCDs, processor cores and threads. When accepted, you can control the number of CCDs to be used, and the number of cores to be used. <ul style="list-style-type: none"> ◆ CCD Control <ul style="list-style-type: none"> – Options available: Auto, 2 CCDs. Default setting is Auto. ◆ Core Control <ul style="list-style-type: none"> – Options available: Auto, TWO(1+1), FOUR(2+2), SIX(3+3), EIGHT(4+4), TEN(5+5), TWELVE(6+6), FOURTEEN(7+7). – Default setting is Auto.
SMT Control	Can be used to disable symmetric multithreading. To re-enable SMT, a POWER CYCLE is needed after select the 'Enable' option. Select 'Auto' base on BIOS PCD. (PcdAmdSmtMode) default setting. <p>Options available: Disabled, Enabled, Auto. Default setting is Auto.</p>

(Note) Advanced items are configurable when this item is defined.

2-3-1-2 Prefetcher Settings

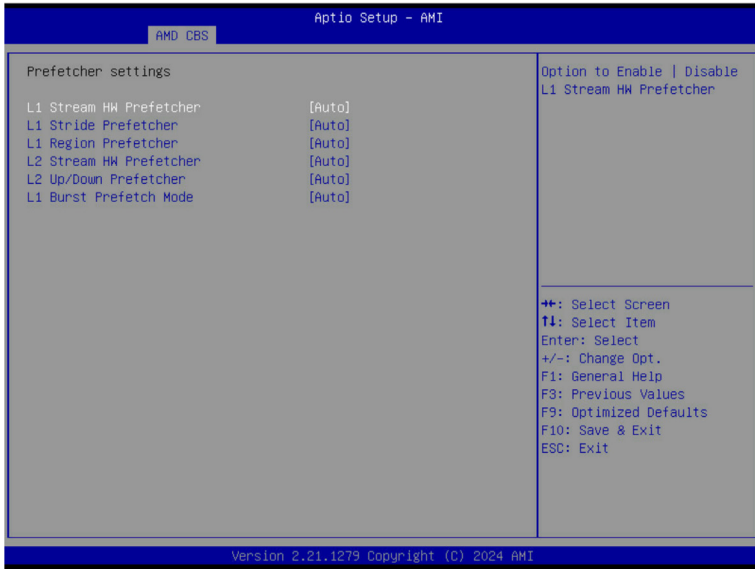

Parameter	Description
Prefetcher settings	
L1 Stream HW Prefetcher	Enable/Disable L1 Stream HW Prefetcher. Options available: Disabled, Enabled, Auto. Default setting is Auto .
L1 Stride Prefetcher	Use memory access history of individual instructions to fetch additional lines when each access is a constant distance from the previous. Enable/Disable L1 Stride Prefetcher. Options available: Disabled, Enabled, Auto. Default setting is Auto .
L1 Region Prefetcher	Use memory access history to fetch additional lines when the data access for a given instruction tends to be followed by other data accesses. Enable/Disable L1 Region Prefetcher. Options available: Disabled, Enabled, Auto. Default setting is Auto .
L2 Stream HW Prefetcher	Enable/Disable L2 Stream HW Prefetcher. Options available: Disabled, Enabled, Auto. Default setting is Auto .
L2 Up/Down Prefetcher	Use memory access history to determine whether to fetch the next or previous line for all memory accesses. Enable/Disable L2 Up/Down Prefetcher. Options available: Disabled, Enabled, Auto. Default setting is Auto .
L1 Burst Prefetch Mode	Enable/Disable L1 Burst Prefetch Mode. Options available: Disabled, Enabled, Auto. Default setting is Auto .

2-3-1-3 Core Watchdog

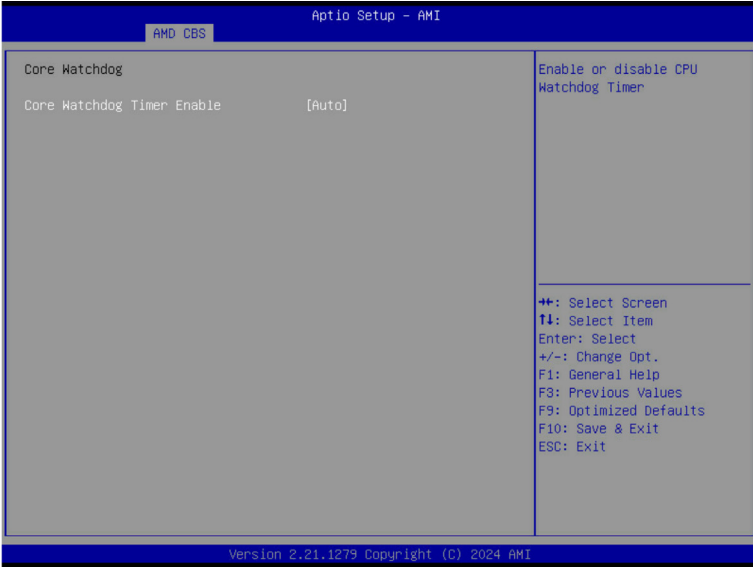

Parameter	Description
Core Watchdog	
Core Watchdog Timer Enable ^(Note)	Enable/Disable CPU Watchdog Timer. Options available: Disabled, Enabled, Auto. Default setting is Auto .
Core Watchdog Timer Interval	Select the CPU Watchdog Timer interval. Options available: 2.681s, 1.340s, 669.41ms, 334.05ms, 166.37ms, 82.53ms, 40.61ms, 20.970ms, 10.484ms, 5.241ms, 2.620ms, 1.309ms, 654.08us, 326.4us, 162.56us, 80.64us, 39.68us, Auto. Default setting is Auto .

(Note) Advanced items prompt when this item is defined.

2-3-2 DF Common Options

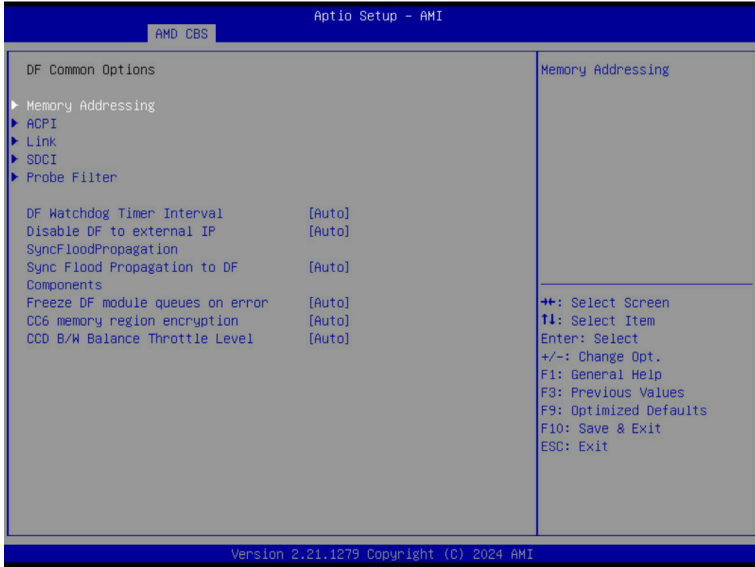

Parameter	Description
DF Common Options	
Memory Addressing	Press [Enter] for configuration of advanced items.
ACPI	Press [Enter] for configuration of advanced items.
Link	Press [Enter] for configuration of advanced items.
SDCI	Press [Enter] for configuration of advanced items.
Probe Filter	Press [Enter] for configuration of advanced items.
DF Watchdog Timer Interval	Configures the Data Fabric watchdog timer interval. Options available: Auto, 41ms, 166ms, 334ms, 669ms, 1.34 seconds, 2.68 seconds, 5.36 seconds. Default setting is Auto .
Disable DF to external IP sync flood propagation	Enable/Disable SyncFlood to UMC & downstream slaves. Options available: Sync flood disabled, Sync flood enabled, Auto. Default setting is Auto .
Sync flood propagation to DF Components	Enable/Disable DF Sync Flood propagation. Options available: Sync flood disabled, Sync flood enabled, Auto. Default setting is Auto .
Freeze DF module queues on error	Options available: Disabled, Enabled, Auto. Default setting is Auto .
CC6 memory region encryption	Controls whether or not the CC6 save/restor memory is encrypted. Options available: Disabled, Enabled, Auto. Default setting is Auto .
CCD B/W Balance Throttle Level	Options available: Auto, Level 0, Level 1, Level 2, Level 3, Level 4. Default setting is Auto .

2-3-2-1 Memory Addressing

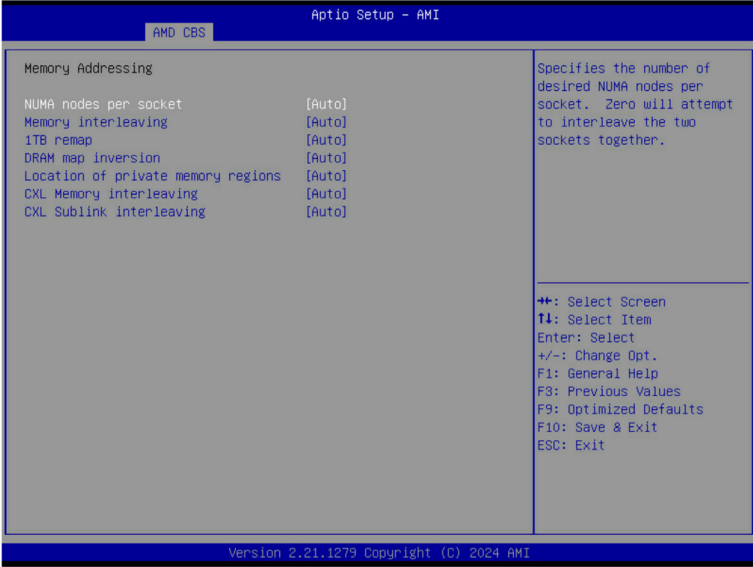

Parameter	Description
Memory Addressing	
NUMA nodes per socket	<p>Specifies the number of desired NUMA nodes per socket. Options available: NPS0, NPS1, NPS2, NPS4, Auto. Default setting is Auto. NOTE!</p> <ul style="list-style-type: none"> • Available options may vary by system configuration. • Only dual processor configuration supports NPS0.
Memory interleaving	<p>Enable/Disable the Memory interleaving feature. Options available: Disabled, Auto, Enabled. Default setting is Auto.</p>
1TB remap	<p>Enable/Disable to remap DRAM out of the space just below the 1TB boundary. The ability to remap depends on DRAM configuration, NPS, and interleaving selection, and may not always be possible. Options available: Do not remap, Attempt to remap, Auto. Default setting is Auto.</p>
DRAM map inversion	<p>Enable/Disable the DRAM map inversion function. Options available: Disabled, Enabled, Auto. Default setting is Auto.</p>
Location of private memory regions	<p>Controls whether or not the private memory regions (PSP, SMU and CC6) are at the top of DRAM or distributed. Options available: Distributed, Consolidated, Auto. Default setting is Auto.</p>
CXL Memory interleaving	<p>Options available: Disabled, Enabled, Auto. Default setting is Auto.</p>
CXL Sublink interleaving	<p>Options available: Enable, Disable, Auto. Default setting is Auto.</p>

2-3-2-2 ACPI

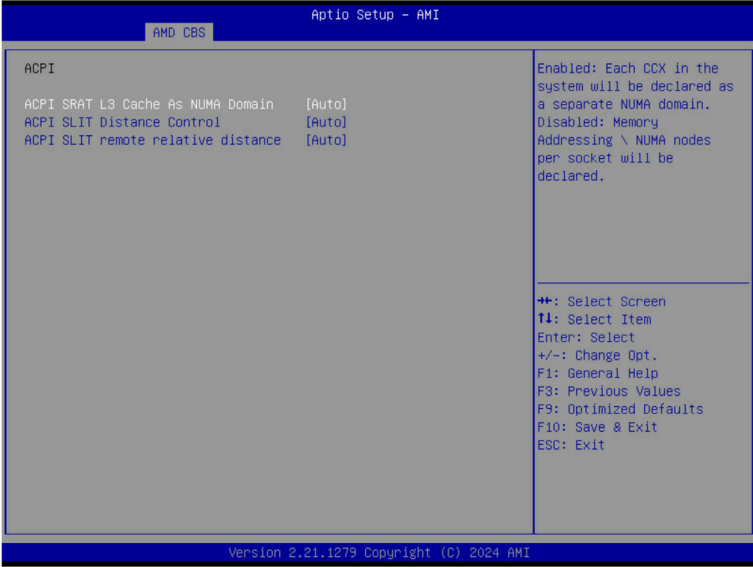

Parameter	Description
ACPI	
ACPI SRAT L3 Cache As NUMA Domain	Enable/Disable report each L3 cache as a NUMA Domain to the OS. Options available: Disabled, Enabled, Auto. Default setting is Auto .
ACPI SLIT Distance Control	Determines how the SLIT distances are declared. Options available: Manual, Auto. Default setting is Auto .
ACPI SLIT remote relative distance	Sets the remote socket distance for 2P systems as near (2.8) or far (3.2). Options available: Near, Far, Auto. Default setting is Auto .

2-3-2-3 Link

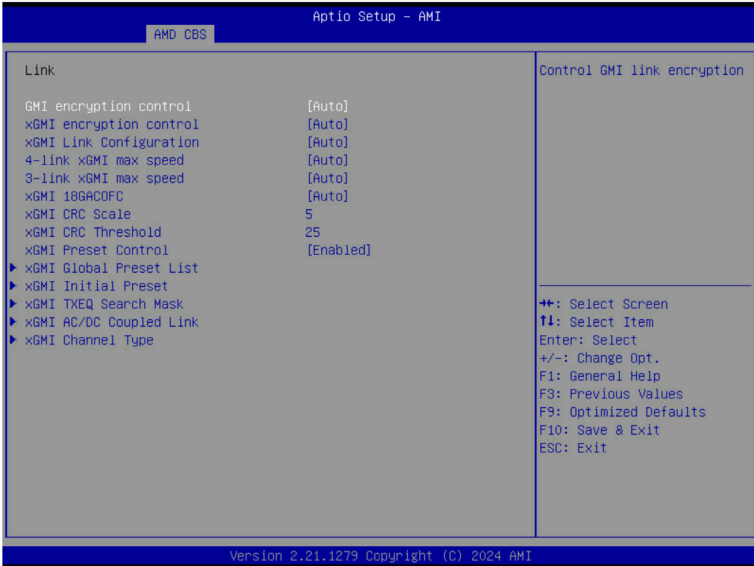

Parameter	Description
GMI encryption control	Enable/Disable GMI link encryption. Options available: Disabled, Enabled, Auto. Default setting is Auto .
xGMI encryption control	Enable/Disable xGMI link encryption. Options available: Disabled, Enabled, Auto. Default setting is Auto .
xGMI Link Configuration	Configures the number of xGMI2 links used on a multi-socket system. Options available: Auto, 3 xGMI Links, 4 xGMI Links, 2 xGMI Links + 2 PCI Links. Default setting is Auto .
4-link xGMI max speed	Specifies the max speed of 4-link xGMI. Options available: 20Gbps, 25Gbps, 32Gbps, Auto. Default setting is Auto .
3-link xGMI max speed	Specifies the max speed of 3-link xGMI. Options available: 120Gbps, 25Gbps, 32Gbps, Auto. Default setting is Auto .
xGMI 18GACOFC	Configures xGMI 18GACOFC. Options available: Auto, Enable, Disable. Default setting is Auto .
xGMI CRC Scale	Configures leaky bucket scale for xGMI and WAFL CRC errors. Every scale milliseconds an error will leak from the CRC counter. Default setting is 7 .
xGMI CRC Threshold	Configures leaky bucket threshold for xGMI and WAFL CRC errors. If link CRC counter exceeds this threshold, an error will be logged. Default setting is 25 .
xGMI Preset Control	Enable/Disable xGMI Preset control. Options available: Disabled, Enabled, Auto. Default setting is Auto .
xGMI Global Preset List	Press [Enter] to configure the xGMI Preset list.
xGMI Initial Preset	Press [Enter] to configure the xGMI Initial Preset CPU link.
xGMI TXEQ Search Mask	Press [Enter] to configure the xGMI TXEQ Search Mask CPU link.

Parameter	Description
xGMI AC/DC Coupled Link	Press [Enter] to configure the xGMI AC/DC Coupled link. ♦ xGMI AC/DC Coupled Link Control ^(Note) – Options available: Manual, Auto. Default setting is Auto .
xGMI Channel Type	Press [Enter] to configure the xGMI Channel Type. ♦ xGMI Channel Type Control ^(Note) – Options available: Manual, Auto. Default setting is Auto .

(Note) Advanced items prompt when this item is defined.

2-3-2-4 SDCI

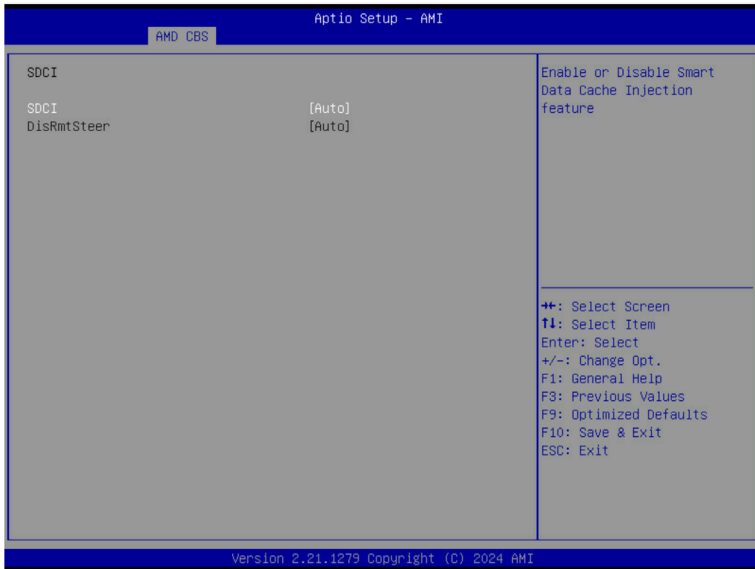

Parameter	Description
SDCI ^(Note)	Options available: Disabled, Enabled, Auto. Default setting is Auto .
DisRmSteer	Options available: Disabled, Enabled, Auto. Default setting is Auto .

(Note) Advanced items prompt when this item is defined.

2-3-2-5 Probe Filter

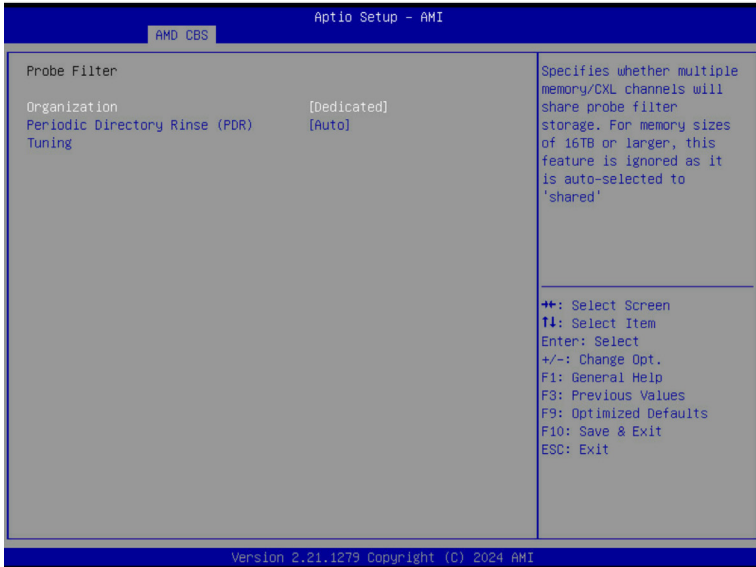

Parameter	Description
Organization	Specifies whether multiple memory/CXL channels will share probe filter storage. Options available: Auto, Dedicated, Shared. Default setting is Dedicated .
Periodic Directory Rinse (PDR)	Controls PDR settings that may impact performance by workload and/or processor.
Tuning	Options available: Memory-Sensitive, Cache-Bound, Neutral, Adaptive, Auto. Default setting is Auto .

2-3-3 UMC Common Options

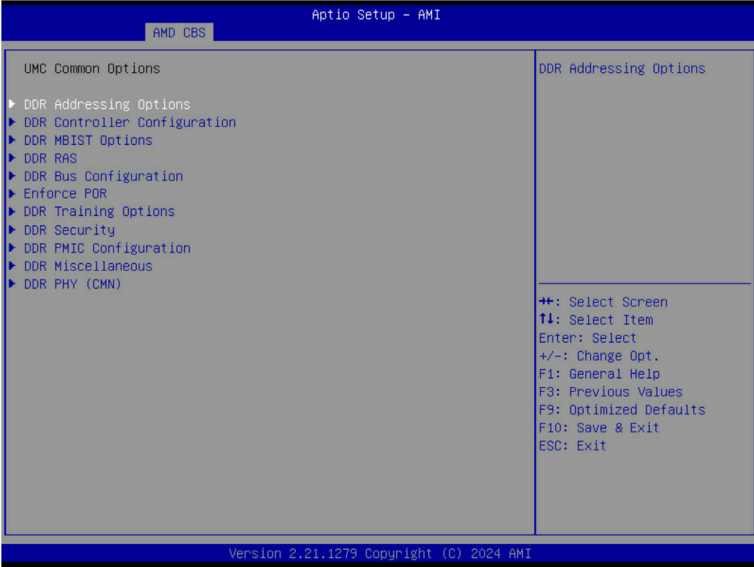

Parameter	Description
UMC Common Options	
DDR Addressing Options	Press [Enter] for configuration of advanced items.
DDR Controller Configuration	Press [Enter] for configuration of advanced items.
DDR MBIST Options	Press [Enter] for configuration of advanced items.
DDR RAS	Press [Enter] for configuration of advanced items.
DDR Bus Configuration	Press [Enter] for configuration of advanced items.
Enforce POR	Press [Enter] for configuration of advanced items.
DDR Training Options	Press [Enter] for configuration of advanced items.
DDR Security	Press [Enter] for configuration of advanced items.
DDR PMIC Configuration	Press [Enter] for configuration of advanced items.
DDR Miscellaneous	Press [Enter] for configuration of advanced items.
DDR PHY (CMN)	Press [Enter] for configuration of advanced items.

2-3-3-1 DDR Addressing Options

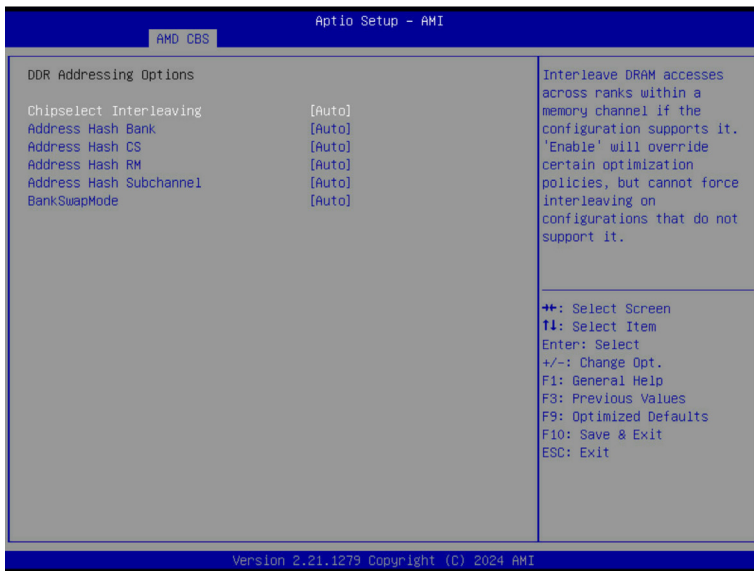

Parameter	Description
DDR Addressing Options	
Chipselect Interleaving	Interleaves memory blocks across the DRAM chip selects for node 0. Options available: Disabled, Enabled, Auto. Default setting is Auto .
Address Hash Bank	Enable or disable bank addressing hashing. Options available: Disabled, Enabled, Auto. Default setting is Auto .
Address Hash CS	Enable or disable CS addressing hashing. Options available: Auto, Enabled, Disabled. Default setting is Auto .
Address Hash RM	Enable or disable RM addressing hashing for 3DS DIMMs. Options available: Auto, Enabled, Disabled. Default setting is Auto .
Address Hash Subchannel	Enable or disable sub-channel addressing hashing. Options available: Auto, Enabled, Disabled. Default setting is Auto .
BankSwapMode	Options available: Auto, Disabled, Swap CPU. Default setting is Auto .

2-3-3-2 DDR Controller Configuration

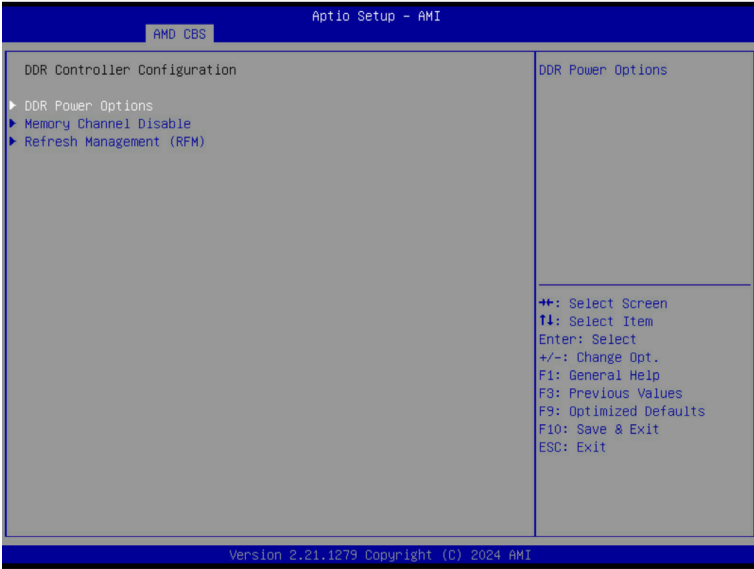

Parameter	Description
DDR Controller Configuration	
DDR Power Options	Press [Enter] for configuration of advanced items.
Memory Channel Disable	Press [Enter] for configuration of advanced items.
Refresh Management (RFM)	Press [Enter] for configuration of advanced items.

2-3-3-2-1 DDR Power Options

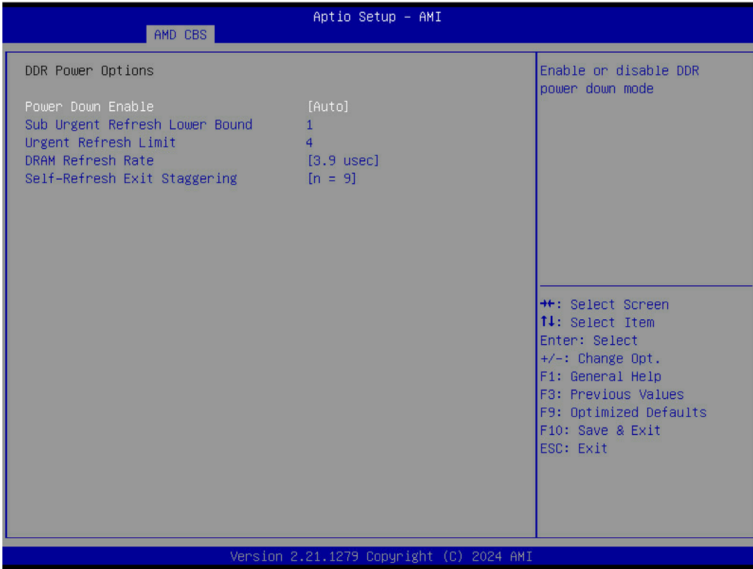

Parameter	Description
DDR Power Options	
Power Down Enable	Enable or disable DDR power down mode. Options available: Disabled, Enabled, Auto. Default setting is Auto .
Sub Urgent Refresh Lower Bound	Specifies the stored refresh limit required to enter sub-urgent refresh mode.
Urgent Refresh Limit	Specifies the stored refresh limit required to enter urgent refresh mode.
DRAM Refresh Rate	DRAM refresh rate: 1.95us or 3.9us. Options available: 3.9 usec, 1.95usec. Default setting is 3.9 usec .
Self-Refresh Exit Staggering	Options available: Disabled, n=1~9. Default setting is n=9 .

2-3-3-2-2 Memory Channel Disable

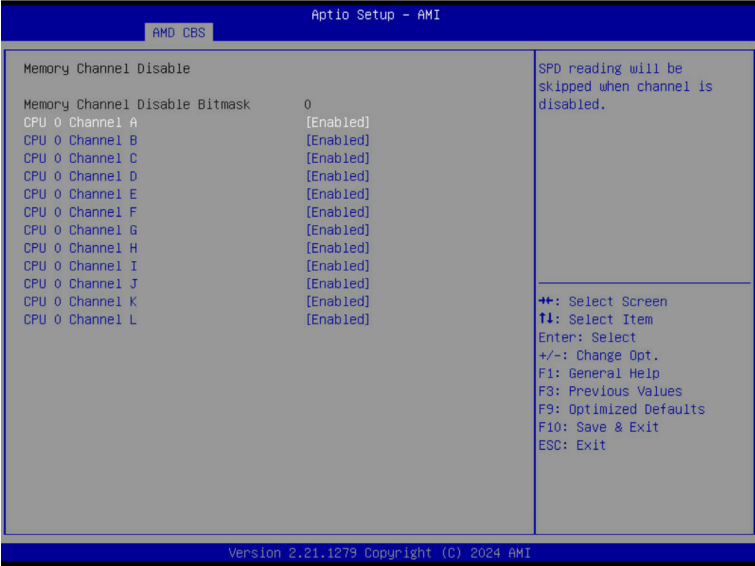

Parameter	Description
Memory Channel Disable	
Memory Channel Disable Bitmask	
Socket 0 Channel_#	Press [Enter] to enable/disable specific memory channel.

2-3-3-2-3 Refresh Management (RFM)

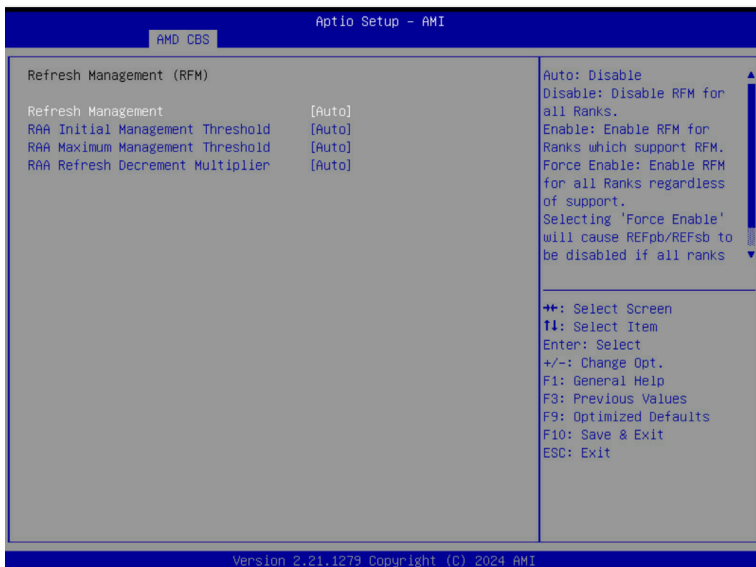

Parameter	Description
Refresh Management (RFM)	
Refresh Management	Configure Refresh Management. Options available: Auto, Disabled, Enabled, Force Enable. Default setting is Auto .
RAA Initial Management Threshold	Override Rolling Accumulated ACT Initial Management Threshold. Options available: 32, 40, 48, 56, 64, 72, 80, Auto. Default setting is Auto .
RAA Maximum Management Threshold	Override Rolling Accumulated ACT Maximum Management Threshold. Options available: 3X, 4X, 5X, 6X, Auto. Default setting is Auto .
RAA Refresh Decrement Multiplier	Override RAA Refresh Decrement Multiplier. Options available: 0.5, 1, Auto. Default setting is Auto .

2-3-3-3 DDR MBIST Options

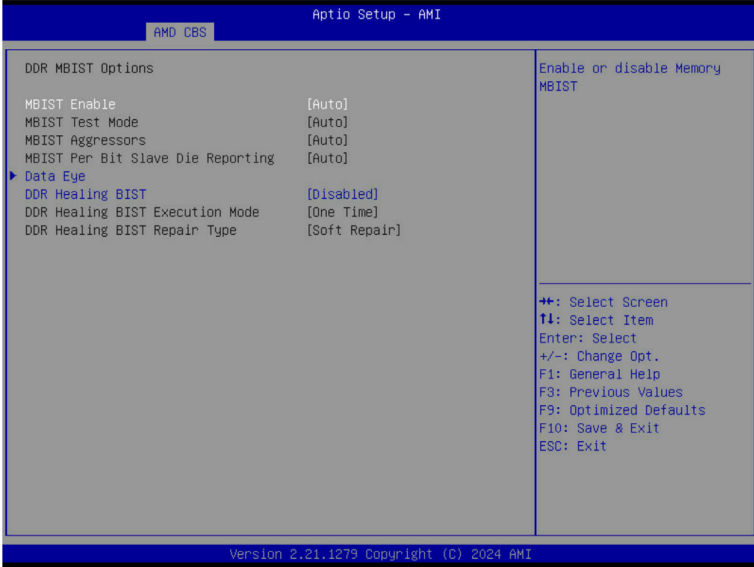

Parameter	Description
DDR MBIST Options	
MBIST Enable	Enable/Disable the Memory MBIST function. Options available: Disabled, Enabled, Auto. Default setting is Auto .
MBIST Test Mode ^(Note1)	Selects MBIST Test Mode. Interface Mode: Tests Single and Multiple CS transactions and Basic Connectivity. Data Eye Mode: Measures Voltage vs. Timing. Options available: Auto, Both, Interface Mode, Data Eye Mode. Default setting is Auto .
MBIST Aggressors ^(Note1)	Enable/Disable MBIST Aggressor test. Options available: Auto, Enabled, Disabled. Default setting is Auto .
MBIST Per Bit Slave Die Reporting ^(Note1)	Enable/Disable to report 2D data eye results in ABL log for each DQ, Chipselect, and Channel. Options available: Auto, Enabled, Disabled. Default setting is Auto .
Data Eye	Press [Enter] to configure advanced items.
Memory Healing BIST	Enable/Disable memory healing BIST. Options available: Disabled, PMU Mem BIST, Self-Healing Mem BIST, PMU and Self-Healing Mem BIST. Default setting is Disabled .

(Note1) This item appears when **MBIST Enable** is set to **Enabled**.

Parameter	Description
DDR Healing BIST Execution Mode ^(Note2)	Options available: One Time, Every boot. Default setting is One Time .
PMU Mem BIST Algorithm ^(Note2)	Press [Enter] to enable/disable PMU Mem BIST Algorithm.
DDR Healing BIST Repair Type ^(Note2)	For DRAM errors found in the BIOS memory BIST select the repair type. Options available: Soft Repair, Hard Repair, No Repairs -Test only. Default setting is Soft Repair .

(Note2) This item appears when **DDR Healing BIST** is defined.

2-3-3-3-1 Data Eye

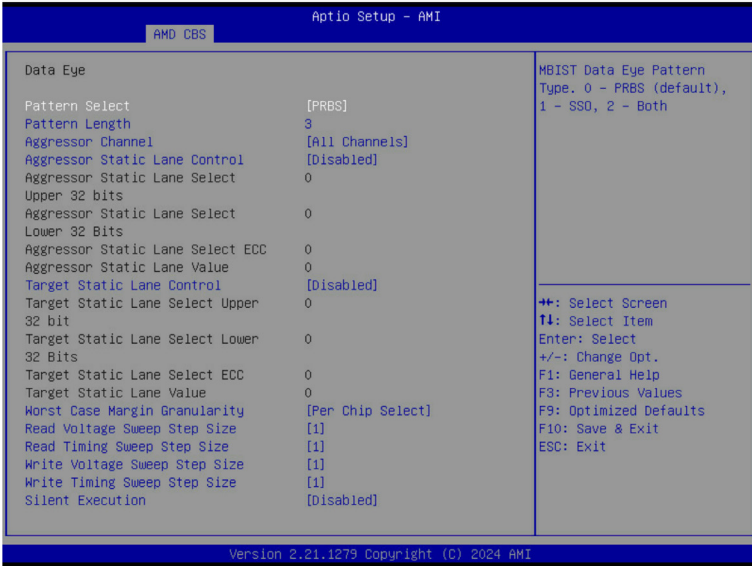

Parameter	Description
Data Eye	
Pattern Select	Options available: PRBS, SSO, Both. Default setting is PRBS .
Pattern Length	Determines the pattern length. The possible options are N=3....12.
Aggressor Channel	This item helps read the aggressors channels. Options available: One Sub-Channel, Half Channels, All Channels. Default setting is All Channels .
Aggressor Static Lane Control	Enable/Disable the Aggressor Static Lane Control function. Options available: Enabled, Disabled. Default setting is Disabled .
Aggressor Static Lane Select Upper 32 bits	This item is configurable when Aggressor Static Lane Control is set to Enabled .
Aggressor Static Lane Select Lower 32 bits	This item is configurable when Aggressor Static Lane Control is set to Enabled .
Aggressor Static Lane Select ECC	This item is configurable when Aggressor Static Lane Control is set to Enabled .
Aggressor Static Lane Value	This item is configurable when Aggressor Static Lane Control is set to Enabled .
Target Static Lane Control	Enable/Disable the Target Static Lane Control function. Options available: Enabled, Disabled. Default setting is Disabled .

Parameter	Description
Target Static Lane Select Upper 32 bits	This item is configurable when Target Static Lane Control is set to Enabled .
Target Static Lane Select Lower 32 bits	This item is configurable when Target Static Lane Control is set to Enabled .
Target Static Lane Select ECC	This item is configurable when Target Static Lane Control is set to Enabled .
Target Static Lane Value	This item is configurable when Target Static Lane Control is set to Enabled .
Worst Case Margin Granularity	Configures Worst Case Margin Granularity. Options available: Per Chip Select, Per Nibble. Default setting is Per Chip Select .
Read Voltage Sweep Step Size	Configures the step size for read Data Eye voltage sweep. Options available: 1, 2, 4. Default setting is 1.
Read Timing Sweep Step Size	Configures the step size for read Data Eye timing sweep. Options available: 1, 2, 4. Default setting is 1.
Write Voltage Sweep Step Size	Configures the step size for write Data Eye voltage sweep. Options available: 1, 2, 4. Default setting is 1.
Write Timing Sweep Step Size	Configures the step size for write Data Eye timing sweep. Options available: 1, 2, 4. Default setting is 1.
Silent Execution	Execute MBIST Data Eye silently without ABL log output. Options available: Enabled, Disabled. Default setting is Disabled .

2-3-3-4 DDR RAS



Parameter	Description
DDR RAS	
Data Poisoning	Enable/Disable the Data Poisoning function. Options available: Auto, Enabled, Disabled. Default setting is Auto .
DRAM Boot Time Post Package Repair	Enable/Disable the DRAM Boot Time Post Package Repair function. Options available: Enabled, Disabled. Default setting is Disabled .
DRAM Runtime Post Package Repair	Enable/Disable the DRAM Runtime Post Package Repair function. Options available: Enabled, Disabled. Default setting is Disabled .
RCD Parity	Enable/Disable the RCD Parity function. Options available: Auto, Enabled, Disabled. Default setting is Enabled .
Max RCD Parity Error Replay	Default setting is 8 .
Disable Memory Error Injection	Options available: False, True, Auto. Default setting is Auto .
ECC Configuration	Press [Enter] to configure advanced items. <ul style="list-style-type: none"> ◆ DRAM ECC Symbol Size <ul style="list-style-type: none"> – Configures the DRAM ECC Symbol Size. – Options available: Auto, x4, x16. Default setting is Auto. ◆ DRAM ECC Enable <ul style="list-style-type: none"> – Enable/Disable DRAM ECC. When set to Auto, it will set ECC to enable. – Options available: Auto, Enabled, Disabled. Default setting is Auto.

Parameter	Description
ECC Configuration (continued)	<ul style="list-style-type: none"> ◆ DRAM UECC Retry <ul style="list-style-type: none"> – Enable/Disable DRAM UECC Retry. – Options available: Auto, Enabled, Disabled. Default setting is Disabled. ◆ Max DRAM UECC Error Replay^(Note) <ul style="list-style-type: none"> – Default setting is 8. ◆ Memory Clear <ul style="list-style-type: none"> – Options available: Auto, Enabled, Disabled. Default setting is Auto. ◆ Address XDR after ECC <ul style="list-style-type: none"> – Options available: Auto, Enabled, Disabled. Default setting is Disabled.
DRAM Scrubbers	<p data-bbox="399 503 732 523">Press [Enter] to configure advanced items.</p> <ul style="list-style-type: none"> ◆ DRAM ECS Mode <ul style="list-style-type: none"> – Options available: Auto, AutomaticECS, ManualECS, DisableECS. Default setting is Auto. ◆ DRAM Redirect Scrubber Enable <ul style="list-style-type: none"> – Options available: Auto, Enabled, Disabled. Default setting is Auto. ◆ DRAM Scrub Redirection Limit <ul style="list-style-type: none"> – Options available: Auto, 8 Scrubs, 4 Scrubs, 2 Scrubs, 1 Scrub. Default setting is Auto. ◆ DRAM Scrub Time <ul style="list-style-type: none"> – Options available: Disabled, 1 hour, 4 hours, 6 hours, 8 hours, 12 hours, 16 hours, 24 hours, 48 hours. Default setting is 24 Hours. ◆ DRAM Error Threshold Count <ul style="list-style-type: none"> – Options available: Auto, ETC_4, ETC_16, ETC_64, ETC_256, ETC_1024, ETC_4096. Default setting is Auto. ◆ DRAM ECS Count Mode <ul style="list-style-type: none"> – Options available: Auto, Row Count Mode, Code Word Count Mode. Default setting is Auto. ◆ DRAM AutoEcs during Self Refresh <ul style="list-style-type: none"> – Options available: Auto, AutoEcs Disabled, AutoEcs Enabled. Default setting is Auto. ◆ DRAM ECS WriteBack Suppression <ul style="list-style-type: none"> – Options available: Auto, Enabled, Disabled. Default setting is Auto. ◆ DRAM X4 WriteBack Suppression <ul style="list-style-type: none"> – Options available: Auto, Enabled, Disabled. Default setting is Auto.

(Note) This item available when **DRAM UECC Retry** is set to **Enabled**.

Parameter	Description
DRAM Corrected Error Counter Enable	Configure DRAM Corrected Error Counter function. Options available: Disable, NoLeakMode, LeakMode. Default setting is LeakMode .
DRAM Corrected Error Counter Interrupt Enable	Enable SMI when DRAM corrected Error Counter count exceeds the threshold value. Options available: False, True. Default setting is True .
DRAM Corrected Counter Leak Rate	Program Rate value for DRAM Corrected Error Counter function. Default setting is 7 .
DRAM Corrected Error Counter Start Count	Program starting value for DRAM Corrected Error Counter function. Default setting is FFF5 .

2-3-3-5 DDR Bus Configuration

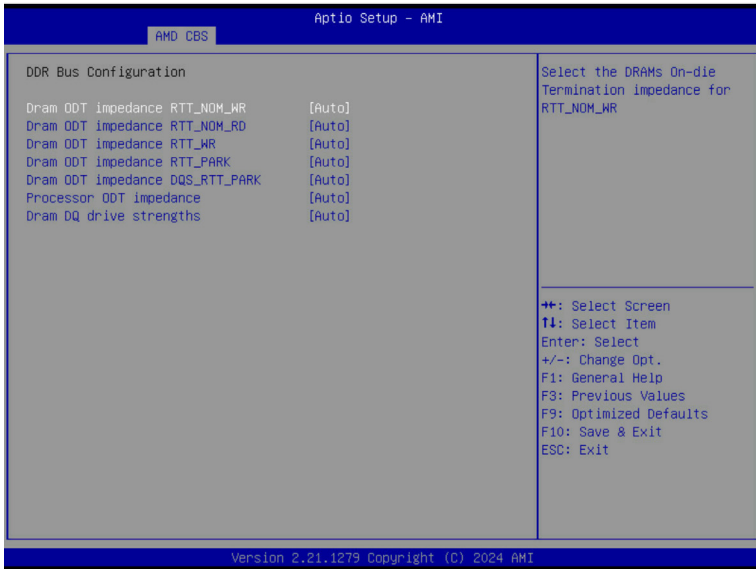

Parameter	Description
DDR Bus Configuration	
Dram ODT impedance RTT_NOM_WR	Select the DRAMs On-die Termination impedance for RTT_NOM_WR. Options available: Auto, RTT_OFF, RZQ (240), RZQ/2 (120), RZQ/3 (80) RZQ/4 (60), RZQ/5(48), RZQ/6(40), RZQ/7(34). Default setting is Auto .
Dram ODT impedance RTT_NOM_RD	Select the DRAMs On-die Termination impedance for RTT_NOM_RD. Options available: Auto, RTT_OFF, RZQ (240), RZQ/2 (120), RZQ/3 (80) RZQ/4 (60), RZQ/5(48), RZQ/6(40), RZQ/7(34). Default setting is Auto .
Dram ODT impedance RTT_WR	Select the DRAMs On-die Termination impedance for RTT_WR. Options available: Auto, RTT_OFF, RZQ (240), RZQ/2 (120), RZQ/3 (80) RZQ/4 (60), RZQ/5(48), RZQ/6(40), RZQ/7(34). Default setting is Auto .
Dram ODT Timpedance RTT_PARK	Select the DRAMs On-die Termination impedance for RTT_PARK. Options available: Auto, RTT_OFF, RZQ (240), RZQ/2 (120), RZQ/3 (80) RZQ/4 (60), RZQ/5(48), RZQ/6(40), RZQ/7(34). Default setting is Auto .
Dram ODT Timpedance DQS_RTT_PARK	Select the DRAMs On-die Termination impedance for DQS_RTT_PARK. Options available: Auto, RTT_OFF, RZQ (240), RZQ/2 (120), RZQ/3 (80) RZQ/4 (60), RZQ/5(48), RZQ/6(40), RZQ/7(34). Default setting is Auto .

Parameter	Description
Processor ODT impedance	Select the ODT impedance for all DBYTE IOs. Options available: Auto, High Impedance, 480 ohm, 240 ohm, 160 ohm, 120 ohm, 96 ohm, 80 ohm, 68.6 ohm, 60 ohm, 53.3 ohm, 48 ohm, 43.6 ohm, 40 ohm, 36.9 ohm, 34.3 ohm, 32 ohm, 30 ohm, 28.2 ohm, 26.7 ohm, 25.3 ohm. Default setting is Auto .
Dram DQ drive strengths	Select the Dram Pull-up and Pull-Down Output Driver Impedance for all DQ and DMI IOs.. Options available: Auto, 48 ohm, 40 ohm, 34 ohm, Default setting is Auto .

2-3-3-6 Enforce POR



Parameter	Description
Enforce POR	Decline/Accept to configure the advanced items.
Accept	
Active Memory Timing Settings ^(Note)	Active memory Timing Settings. Options available: Auto, Enabled. Default setting is Auto .
Memory Target Speed	Specifies the memory target speed in MT/s. Options available: Auto, DDR3200, DDR4000, DDR4400, DDR4800, DDR5200, DDR5600. Default setting is Auto .
SPD Timing	Press [Enter] to configure advanced items.
Non-SPD Timing	Press [Enter] to configure advanced items.

(Note) Advanced items prompt when this item is defined.

2-3-3-7 DDR Training Options

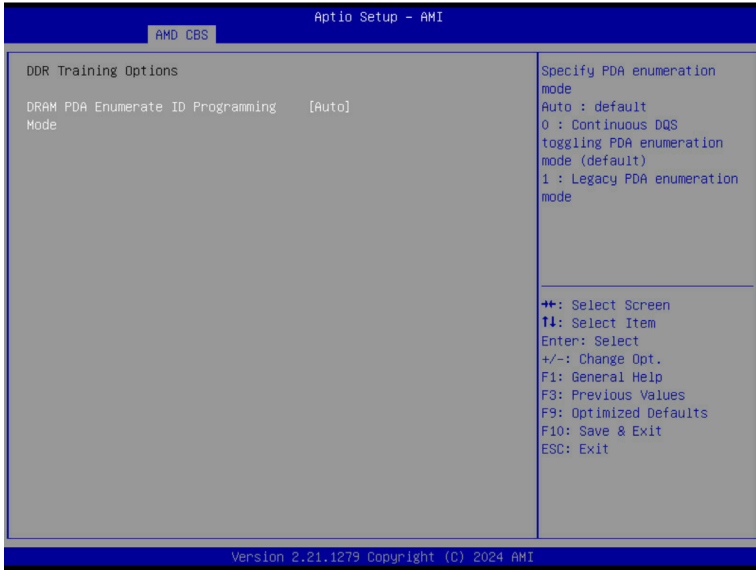

Parameter	Description
DDR Training Options	
DRAM PDA Enumerate ID Programming Mode	Specify PDA enumeration mode. Options available: Auto, Toggling PDA enumeration mode, Legacy PDA enumeration mode. Default setting is Auto .

2-3-3-8 DDR Security



Parameter	Description
Security	
TSME	Enable/Disable Transparent SME. Options available: Auto, Enabled, Disabled. Default setting is Auto .
AES	Options available: AES-128, AES-256. Default setting is AES-256 .
Data Scramble	Enable/Disable Data Scrambling. Options available: Enabled, Disabled. Default setting is Enabled .
SME-MK	Options available: Enabled, Disabled. Default setting is Disabled .

2-3-3-9 DDR PMIC Configuration

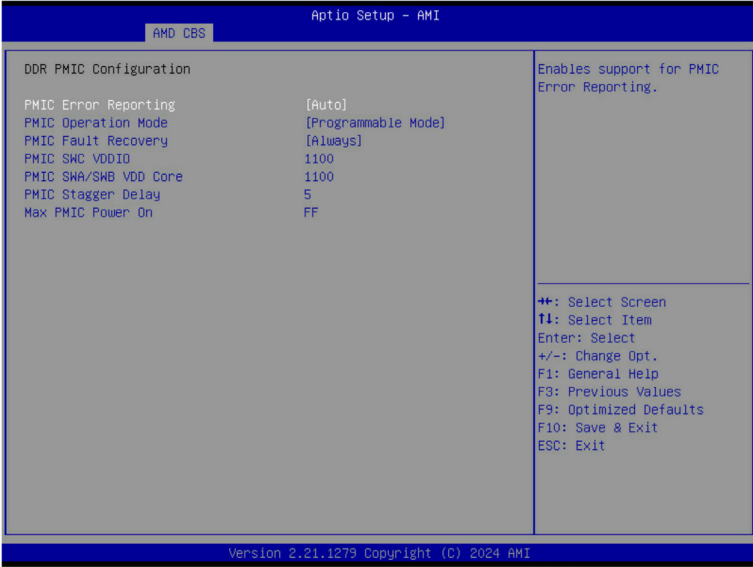

Parameter	Description
DDR PMIC Configuration	
PMIC Error Reporting	Enables support for PMIC Error Reporting. Options available: Auto, False, True. Default setting is Auto .
PMIC Operation Mode	Options available: Secure Mode, Programmable Mode. Default setting is Programmable Mode .
PMIC Fault Recovery	Options available: Always, Never, Once. Default setting is Always .
PMIC SWC VDDIO	Default setting is 1100 .
PMIC SWA/SWB VDD Core	Default setting is 1100 .
PMIC Stagger Delay	Default setting is 5 .
Max PMIC Power On	Default setting is FF .

2-3-3-10 DDR Miscellaneous

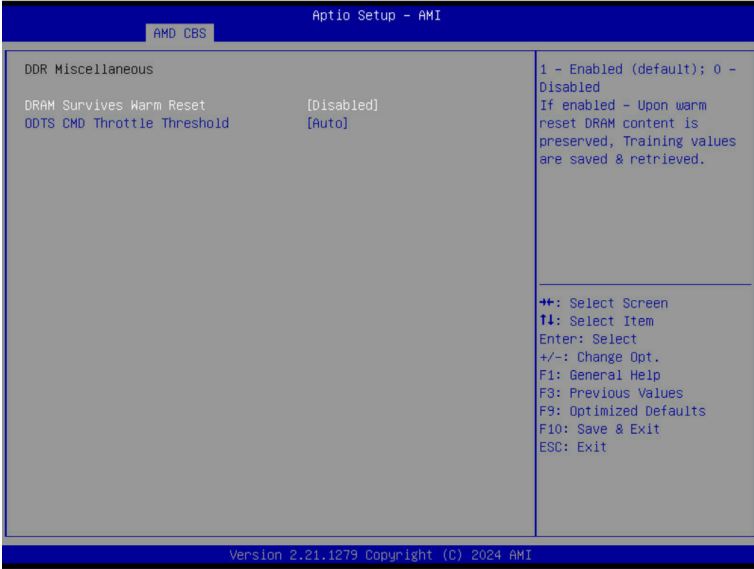

Parameter	Description
DDR Miscellaneous	
DRAM Survives Warm Reset	Options available: Enabled, Disabled. Default setting is Disabled .
ODTS CMD Throttle Threshold	Options available: Auto, > 85°C, > 90°C, > 95°C. Default setting is Auto .

2-3-3-11 DDR PHY (CMN)



Parameter	Description
DDR PHY (CMN)	
Periodic Training ^(Note)	Options available: Auto, Enabled, Disabled. Default setting is Auto .
Periodic Training Interval	Specifies the Periodic Training interval in millisecond.

(Note) Advanced items prompt when this item is defined.

2-3-4 NBIO Common Options

Aptio Setup - AMI

AMD CBS

NBIO Common Options		Enable/Disable IOMMU
IOMMU	[Auto]	↑↓: Select Screen ↑: Select Item Enter: Select +/-: Change Opt. F1: General Help F3: Previous Values F9: Optimized Defaults F10: Save & Exit ESC: Exit
DMAR Support	[Auto]	
DMA Protection	[Auto]	
DRTM Virtual Device Support	[Auto]	
DRTM Memory Reservation	[Auto]	
ACS Enable	[Auto]	
PCIe ARI Support	[Auto]	
PCIe ARI Enumeration	[Auto]	
PCIe Ten Bit Tag Support	[Auto]	
▶ SMU Common Options		
▶ NBIO RAS Common Options		
Enable AER Cap	[Auto]	
Early Link Speed	[Auto]	
Hot Plug Handling mode	[Auto]	
Hot Plug Allow FF in Synchronous	[Disabled]	
Presence Detect Select mode	[Auto]	
Data Link Feature Cap	[Auto]	
CV test	[Auto]	
SEV-SNP Support	[Auto]	
Allow Compliance	[Auto]	
SRIS	[Auto]	
Multi Upstream Auto Speed Change	[Auto]	

Version 2.21.1279 Copyright (C) 2024 AMI

Aptio Setup - AMI

AMD CBS

PCIe ARI Enumeration	[Auto]	Enable this setting to use 2 symbols per clock for devices at Gen 4 speed. ↑↓: Select Screen ↑: Select Item Enter: Select +/-: Change Opt. F1: General Help F3: Previous Values F9: Optimized Defaults F10: Save & Exit ESC: Exit
PCIe Ten Bit Tag Support	[Auto]	
▶ SMU Common Options		
▶ NBIO RAS Common Options		
Enable AER Cap	[Auto]	
Early Link Speed	[Auto]	
Hot Plug Handling mode	[Auto]	
Hot Plug Allow FF in Synchronous	[Disabled]	
Presence Detect Select mode	[Auto]	
Data Link Feature Cap	[Auto]	
CV test	[Auto]	
SEV-SNP Support	[Auto]	
Allow Compliance	[Auto]	
SRIS	[Auto]	
Multi Upstream Auto Speed Change	[Auto]	
Multi Auto Speed Change On Last Rate	[Auto]	
PCIe Link Speed Capability	[Auto]	
RTM Margining Support	[Auto]	
EQ Bypass To Highest Rate	[Auto]	
Non-PCIe Compliant Support	[Auto]	
PCIe Idle Power Setting	[Optimize for Perf/Power]	
▶ nBif Common Options		
▶ Link EQ Preset Options		
Enable 2 SPC (Gen 4)	[Auto]	

Version 2.21.1279 Copyright (C) 2024 AMI

Parameter	Description
NBIO Common Options	
IOMMU	Enable/Disable the IOMMU function. Options available: Disabled, Enabled, Auto. Default setting is Auto .
DMAr Support	Enable/Disable DMAr system protection during POST. Options available: Disabled, Enabled, Auto. Default setting is Auto .
DMA Protection	Enable/Disable DMA remap support in IVRS IVinfo Field. Options available: Auto, Enabled, Disabled. Default setting is Auto .
DRTM Virtual Device Support	Enable/Disable DRTM ACPI virtual device. Options available: Disabled, Enabled, Auto. Default setting is Auto .
DRTM Memory Reservation	Enable/Disable DRTM Memory reservation. Options available: Disabled, Enabled, Auto. Default setting is Auto .
ACS Enable	Enable/Disable ACS. Options available: Enabled, Disabled, Auto. Default setting is Auto .
PCIe ARI Support	Enable/Disable Alternative Routing-ID Interpretation. Options available: Disabled, Enabled, Auto. Default setting is Auto .
PCIe ARI Enumeration	ARI Forwarding Enable for each downstream port. Options available: Disabled, Enabled, Auto. Default setting is Auto .
PCIe Ten Bit Tag Support	Enable/Disable PCIe ten bit tags for supported devices. (Auto=Disabled) Options available: Disabled, Enabled, Auto. Default setting is Auto .
SMU Common Options	Press [Enter] for configuration of advanced items.
NBIO RAS Common Options	Press [Enter] for configuration of advanced items.
Enable AER Cap	Enable/Disable Advanced Error Reporting Capability. Options available: Enable, Disabled, Auto. Default setting is Auto .
Early Link Speed	Configures Early Link Speed. Options available: Auto, Gen1, Gen2. Default setting is Auto .
Hot Plug Handling mode	Controls the Hot Plug Handling mode. Options available: OS First, Firmware First/EDR if OS supports, Firmware First but allow OS First, System Firmware Intermediary, Auto. Default setting is Auto .
Hot Plug Allow FF in Synchronous	Allows firmware first hot plug handling mode to operate in mode A and mode B synchronous mappings. Options available: Disabled, Enabled. Default setting is Disabled .
Presence Detect Select mode	Controls the Presence Detect Select mode. Options available: OR, AND, In-Band Only, Out-of -Band Only, Auto. Default setting is Auto .

Parameter	Description
Data Link Feature Cap	Enable/Disable the data link feature capability. Options available: Enabled, Disabled, Auto. Default setting is Auto .
CV test	Enable/Disable the running PCIE CV tool support. Options available: Auto, Enabled, Disabled. Default setting is Auto .
SEV-SNP Support	Enable/Disable the SEV-SNP support. Options available: Disable, Enable. Default setting is Disable .
Allow Compliance	When enabled, allows the PCIe RP to enter Polling.Compliance state. Options available: Auto, Disable, Enable. Default setting is Auto .
SRIS	Options available: Auto, Disable, Enable. Default setting is Auto .
Multi Upstream Auto Speed Change	Defines the setting of this feature for all PCIe devices. Options available: Disabled, Enabled, Auto. Default setting is Auto .
Multi Auto Speed Change On Last Rate	Options available: Disable, Enable, Auto. Default setting is Auto .
PCIE Link Speed Capability	Options available: Maximum speed, Gen1, Gen2, Gen3, Gen4, Gen5, Auto. Default setting is Auto .
RTM Margining Support	Options available: Disable, Enable, Auto. Default setting is Auto .
EQ Bypass To Highest Rate	Options available: Disable, Enable, Auto. Default setting is Auto .
Non-PCIe Compliant Support	Options available: Disable, Enable, Auto. Default setting is Auto .
PCIE Idle Power Setting	Modify PCIE Power Savings Features that can impact lightly loaded latency. Options available: Optimize for Latency, Optimize for Perf/Power. Default setting is Optimize for Latency .
nBif Common Options	Press [Enter] for configuration of advanced items.
Link EQ Preset Options	Press [Enter] for configuration of advanced items.
Enable 2 SPC (Gen4)	Enable this setting to use 2 symbols per clock for devices at Gen4 speed. Options available: Auto, Enabled. Default setting is Auto .

2-3-4-1 SMU Common Options

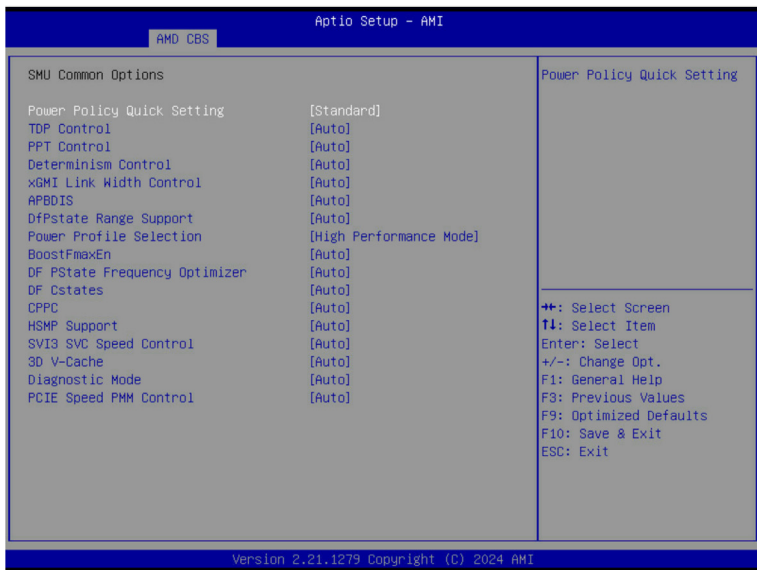

Parameter	Description
SMU Common Options	
Power Policy Quick Setting	Options available: Standard, Best Performance, Energy Efficient. Default setting is Standard .
TDP Control	Options available: Manual, Auto. Default setting is Auto .
PPT Control	Options available: Manual, Auto. Default setting is Auto .
Determinism Control	Selects use the fused Determinism or set customized Determinism. Options available: Manual, Auto. Default setting is Auto .
xGMI Link Width Control	Options available: Manual, Auto. Default setting is Auto .
APBDIS	Options available: 0, 1, Auto. Default setting is Auto .
DfPstate Range Support	Options available: Disable, Enable, Auto. Default setting is Auto .
Power Profile Selection	Options available: High Performance Mode, Efficiency Mode, Maximum IO Performance Mode, Balanced Memory Performance Mode. Default setting is High Performance Mode .
BoostFmaxEn	Options available: Manual, Auto. Default setting is Auto .
DF PState Frequency Optimizer	Options available: Auto, Enabled, Disabled. Default setting is Auto .
DF Cstates	Options available: Disabled, Enabled, Auto. Default setting is Auto .

Parameter	Description
CPPC	Enable/Disable the CPPC feature. Options available: Disabled, Enabled, Auto. Default setting is Auto .
HSMP Support	Enable/Disable the HSMP support. Options available: Disabled, Enabled, Auto. Default setting is Auto .
SVI3 SVC Speed Control	Options available: Auto, Manual. Default setting is Auto .
3D V-Cache	Options available: Auto, Disable, 1 stack. Default setting is Auto .
Diagnostic Mode	Options available: Disabled, Enabled, Auto. Default setting is Auto .
PCIe Speed PMM Control	Options available: Dynamic link speed determined by Power Management functionality, Static Target Link Speed (GEN4), Static Target Link Speed (GEN5), Auto. Default setting is Auto .

2-3-4-2 NBIO RAS Common Options

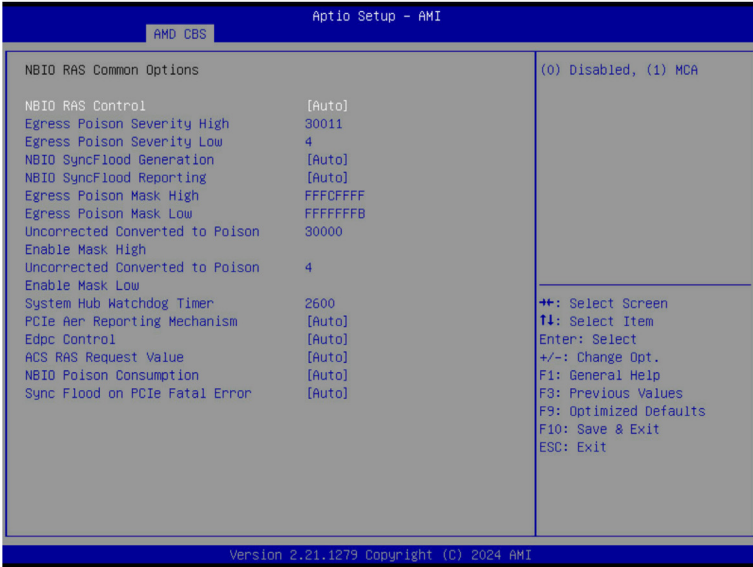

Parameter	Description
NBIO RAS Common Options	
NBIO RAS Control	Options available: Disabled, MCA, Auto. Default setting is Auto .
Egress Poison Severity High	Configures the Egress Poison High Severity. Each bit set to 1 enables High severity on the associated IOHC egress port. A bit of 0 indicates LOW severity.
Egress Poison Severity Low	Configures the Egress Poison Low Severity. Each bit set to 1 enables High severity on the associated IOHC egress port. A bit of 0 indicates LOW severity.
NBIO SyncFlood Generation	The value may be used to mask SyncFlood caused by NBIO RAS options. Options available: Enabled, Disabled, Auto. Default setting is Auto .
NBIO SyncFlood Reporting	The value may be used to enable SyncFlood reporting to APML. Options available: Enabled, Disabled, Auto. Default setting is Auto .
Egress Poison Mask High	Enables mask for masking of errors logged in EGRESS_POISON_STATUS. For each bit set to 1, errors are masked. For each bit set to 0, errors trigger response actions.
Egress Poison Mask Low	Enables mask for masking of errors logged in EGRESS_POISON_STATUS. For each bit set to 1, errors are masked. For each bit set to 0, errors trigger response actions.

Parameter	Description
Uncorrected Converted to Poison Enable Mask High	Enables mask for masking of uncorrectable parity errors on internal arrays.
Uncorrected Converted to Poison Enable Mask Low	Enables mask for masking of uncorrectable parity errors on internal arrays.
System Hub Watchdog Timer	Specifies the timer interval of the SYSHUB Watchdog timer in milliseconds.
PCIe Aer Reporting Mechanism	Selects the method of reporting AER errors from PCI Express. Options available: Firmware First, Firmware First but allow OS First, OS First, Auto. Default setting is Auto .
Edpc Control	Options available: Disabled, Enabled, Auto. Default setting is Auto .
ACS RAS Request Value	Options available: Direct Request Access Enabled, Request Blocking Enabled, Request Redirect Enabled, Auto. Default setting is Auto .
NBIO Poison Consumption	Options available: Auto, Enabled, Disabled. Default setting is Auto .
Sync Flood on PCIe Fatal Error	Options available: Auto, True, False. Default setting is Auto .

2-3-4-3 nBif Common Options

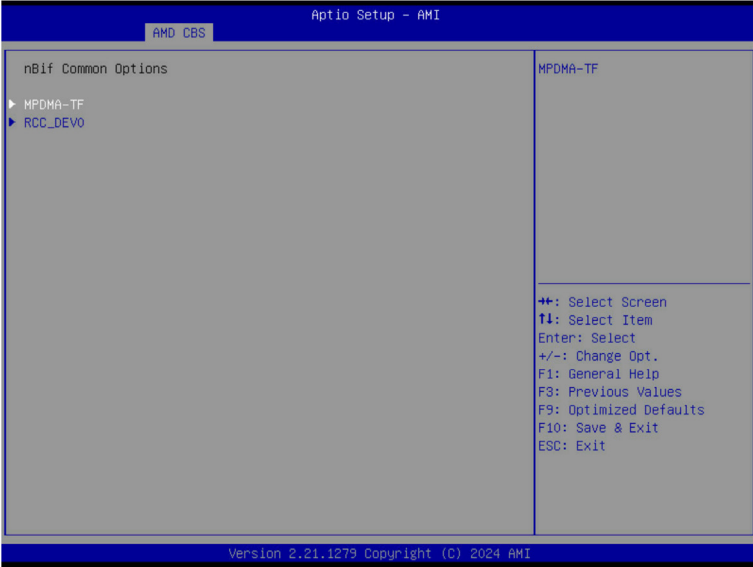

Parameter	Description
MPDMA-TF	<ul style="list-style-type: none"> ◆ SRIOV <ul style="list-style-type: none"> – Options available: Auto, Disable, Enable. Default setting is Auto. ◆ ARI <ul style="list-style-type: none"> – Options available: Auto/Default, Disable, Enable. Default setting is Auto/Default. ◆ AER <ul style="list-style-type: none"> – Options available: Auto, Disable, Enable. Default setting is Auto. ◆ ACS <ul style="list-style-type: none"> – Options available: Auto, Disable, Enable. Default setting is Auto. ◆ ATS <ul style="list-style-type: none"> – Options available: Auto, Disable, Enable. Default setting is Auto. ◆ PASID <ul style="list-style-type: none"> – Options available: Auto, Disable, Enable. Default setting is Auto. ◆ RTR <ul style="list-style-type: none"> – Options available: Auto, Disable, Enable. Default setting is Auto. ◆ PAGE_REQ <ul style="list-style-type: none"> – Options available: Auto, Disable, Enable. Default setting is Auto. ◆ PWR <ul style="list-style-type: none"> – Options available: Auto, Disable, Enable. Default setting is Auto. ◆ ATC_ENABLE <ul style="list-style-type: none"> – Options available: Auto, Disable, Enable. Default setting is Auto.

Parameter	Description
RCC_DEV0	<ul style="list-style-type: none"> ◆ ACS Rcc_Dev0 <ul style="list-style-type: none"> – Options available: Auto, Disable, Enable. Default setting is Auto.
	<ul style="list-style-type: none"> ◆ AER Rcc_Dev0 <ul style="list-style-type: none"> – Options available: Auto, Disable, Enable. Default setting is Auto.
	<ul style="list-style-type: none"> ◆ DllEnableStrap1 <ul style="list-style-type: none"> – Options available: Auto, Disable, Enable. Default setting is Auto.
	<ul style="list-style-type: none"> ◆ Phy16GTStrap1 <ul style="list-style-type: none"> – Options available: Auto, Disable, Enable. Default setting is Auto.
	<ul style="list-style-type: none"> ◆ MarginEnStrap1 <ul style="list-style-type: none"> – Options available: Auto, Disable, Enable. Default setting is Auto.
	<ul style="list-style-type: none"> ◆ SourceValStrap5 <ul style="list-style-type: none"> – Options available: Auto, Disable, Enable. Default setting is Auto.
	<ul style="list-style-type: none"> ◆ TranslationalBlockingStrap5 <ul style="list-style-type: none"> – Options available: Auto, Disable, Enable. Default setting is Auto.
	<ul style="list-style-type: none"> ◆ P2pReq ACS Control <ul style="list-style-type: none"> – Options available: Auto, Disable, Enable. Default setting is Auto.
	<ul style="list-style-type: none"> ◆ P2pCompStrap5 <ul style="list-style-type: none"> – Options available: Auto, Disable, Enable. Default setting is Auto.
	<ul style="list-style-type: none"> ◆ UpstreamFwdStrap5 <ul style="list-style-type: none"> – Options available: Auto, Disable, Enable. Default setting is Auto.
	<ul style="list-style-type: none"> ◆ P2PEgressStrap5 <ul style="list-style-type: none"> – Options available: Auto, Disable, Enable. Default setting is Auto.
	<ul style="list-style-type: none"> ◆ DirectTranslatedStrap5 <ul style="list-style-type: none"> – Options available: Auto, Disable, Enable. Default setting is Auto.
	<ul style="list-style-type: none"> ◆ SsidEnStrap5 <ul style="list-style-type: none"> – Options available: Auto, Disable, Enable. Default setting is Auto.
	<ul style="list-style-type: none"> ◆ PriEnPageReq <ul style="list-style-type: none"> – Options available: Auto, Disable, Enable. Default setting is Auto.
	<ul style="list-style-type: none"> ◆ PriResetPageReq <ul style="list-style-type: none"> – Options available: Auto, Disable, Enable. Default setting is Auto.
	<ul style="list-style-type: none"> ◆ SourceVal ACS cntl <ul style="list-style-type: none"> – Options available: Auto, Disable, Enable. Default setting is Auto.
	<ul style="list-style-type: none"> ◆ TranslationalBlocking ACS Control <ul style="list-style-type: none"> – Options available: Auto, Disable, Enable. Default setting is Auto.
	<ul style="list-style-type: none"> ◆ P2pComp ACS Control <ul style="list-style-type: none"> – Options available: Auto, Disable, Enable. Default setting is Auto.
	<ul style="list-style-type: none"> ◆ UpstreamFwd ACS Control <ul style="list-style-type: none"> – Options available: Auto, Disable, Enable. Default setting is Auto.
	<ul style="list-style-type: none"> ◆ P2PEgress ACS Control <ul style="list-style-type: none"> – Options available: Auto, Disable, Enable. Default setting is Auto.
	<ul style="list-style-type: none"> ◆ P2pReqStrap5 <ul style="list-style-type: none"> – Options available: Auto, Disable, Enable. Default setting is Auto.
	<ul style="list-style-type: none"> ◆ E2E_PREFIX <ul style="list-style-type: none"> – Options available: Auto, Disable, Enable. Default setting is Auto.

Parameter	Description
RCC_DEV0 (continued)	♦ EXTENDED_FMT – Options available: Auto, Disable, Enable. Default setting is Auto .

2-3-4-4 Link EQ Preset Options

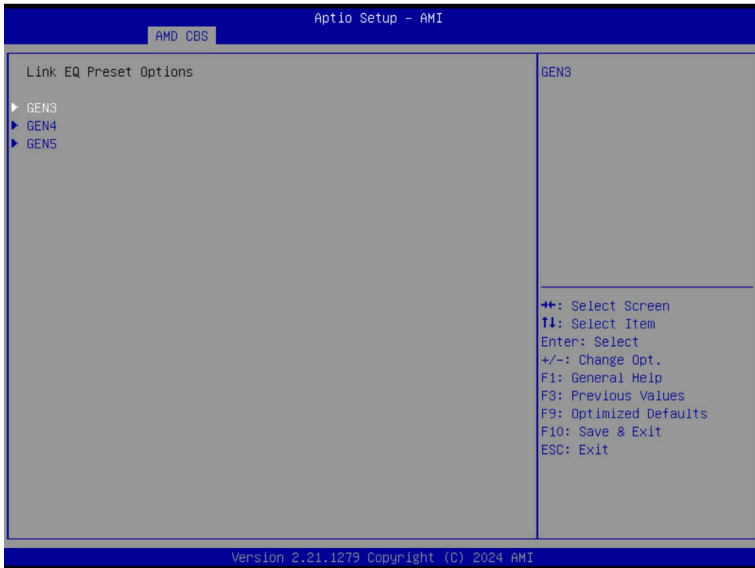

Parameter	Description
GEN3/4/5	Press [Enter] to configure advanced items. <ul style="list-style-type: none">◆ Preset Search Mask Configuration<ul style="list-style-type: none">– Options available: Custom, Auto. Default setting is Auto.

2-3-5 FCH Common Options

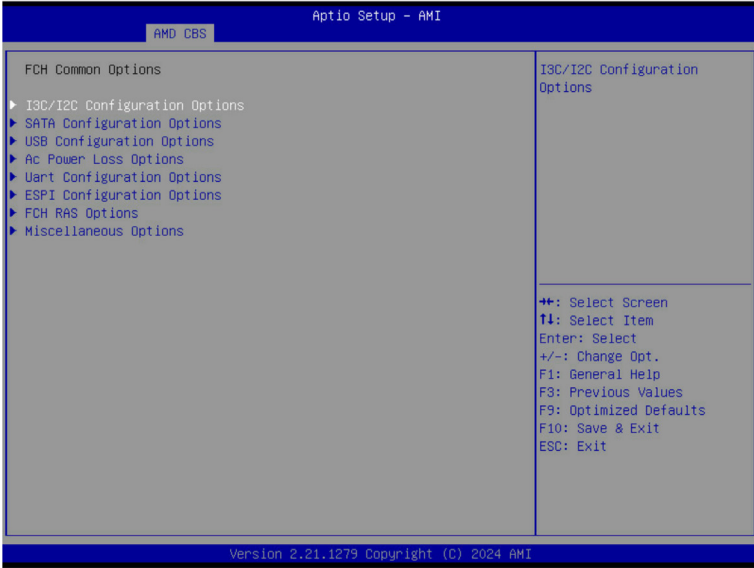

Parameter	Description
FCH Common Options	
I3C/I2C Configuration Options	Press [Enter] for configuration of advanced items.
SATA Configuration Options	Press [Enter] for configuration of advanced items.
USB Configuration Options	Press [Enter] for configuration of advanced items.
AC Power Loss Options	Press [Enter] for configuration of advanced items.
Uart Configuration Options	Press [Enter] for configuration of advanced items.
ESPI Configuration Options	Press [Enter] for configuration of advanced items.
FCH RAS Options	Press [Enter] for configuration of advanced items.
Miscellaneous Options	Press [Enter] for configuration of advanced items.

2-3-5-1 I3C/I2C Configuration Options



Parameter	Description
I3C/I2C Configuration Options	
I3C/I2C 0/1/2/3 Enable	Options available: Both Disabled, I3C Enabled, I2C Enabled, Auto. Default setting is Auto .
I2C 4/5 Enable	Options available: Disabled, Enabled, Auto. Default setting is Auto .
Release SPD Host Control	Options available: Disabled, Enabled. Default setting is Disabled .
PMFW Poll DDR5 Telemetry	Options available: Disabled, Enabled. Default setting is Enabled .
Ixc Telemetry Ports Fence Control	Options available: Disabled, Enabled. Default setting is Disabled .
I2C SDA Hold Override	Options available: Disabled, Enabled, Auto. Default setting is Auto .
APML SB-TSI & RMI Mode	Options available: I3C, I2C. Default setting is I3C .
I3C Mode Speed	Options available: SDR2(6MHz), SDR0(12.5MHz), Auto. Default setting is Auto .
I3C Push Pull HCNT Value	SCL push-pull High count for I3C transfers targeted to I3C devices.
I3C SDA Hold Override	Override I3C SDA Hold value. Options available: Disabled, Enabled, Auto. Default setting is Auto .

2-3-5-2 SATA Configuration Options

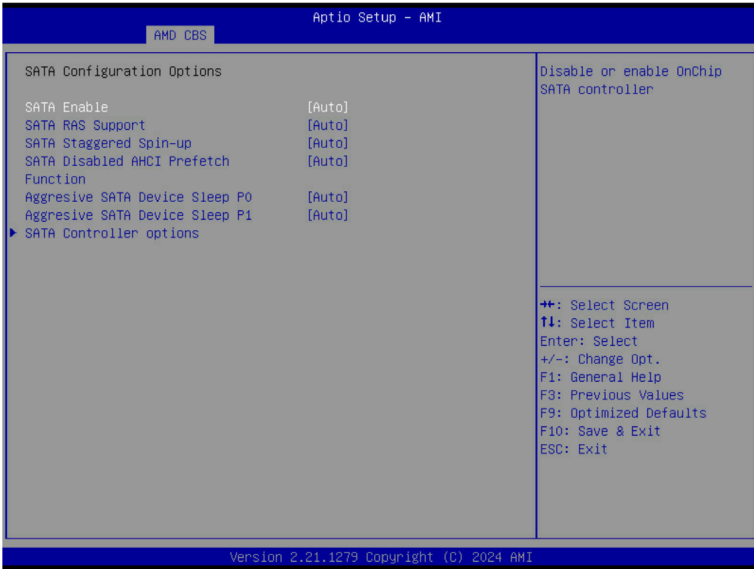

Parameter	Description
SATA Configuration Options	
SATA Enable	Enable/Disable OnChip SATA controller. Options available: Disabled, Enabled, Auto. Default setting is Auto .
SATA RAS Support	Options available: Disabled, Enabled, Auto. Default setting is Auto .
SATA Staggered Spin-up	Options available: Disabled, Enabled, Auto. Default setting is Auto .
SATA Disabled AHCI Prefetch Function	Options available: Disabled, Enabled, Auto. Default setting is Auto .
Aggressive SATA Device Sleep P0/P1	Options available: Disabled, Enabled, Auto. Default setting is Auto .
SATA Controller options	Press [Enter] for configuration of advanced items. <ul style="list-style-type: none"> ◆ SATA Controller Enable ◆ SATA Controller eSATA ◆ SATA Controller DevSlp ◆ SATA Controller SGPIO

2-3-5-3 USB Configuration Options

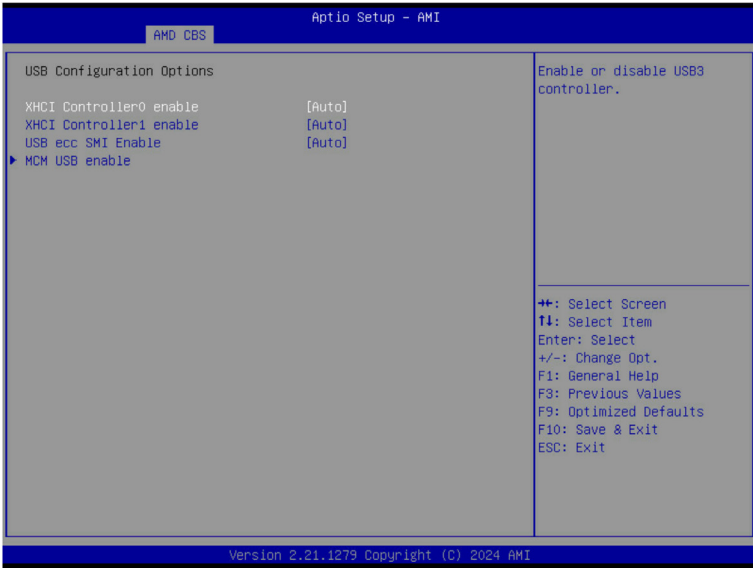

Parameter	Description
USB Configuration Options	
XHCI Controller0/1 enable	Enable/Disable USB controller. Options available: Enabled, Disabled, Auto. Default setting is Auto .
USB ecc SMI Enable	Options available: Enable, Off, Auto. Default setting is Auto .
MCM USB enable	Press [Enter] for configuration of advanced items. <ul style="list-style-type: none"> ◆ XHCI2/ XHCI3 enable (Socket1) <ul style="list-style-type: none"> – Options available: Enabled, Disabled, Auto. Default setting is Auto.

2-3-5-4 AC Power Loss Options



Parameter	Description
AC Power Loss Options	
AC Loss Control	Selects the AC Loss Control Method. Options available: Power Off, Power On, Last State. Default setting is Last State .

2-3-5-5 Uart Configuration Options

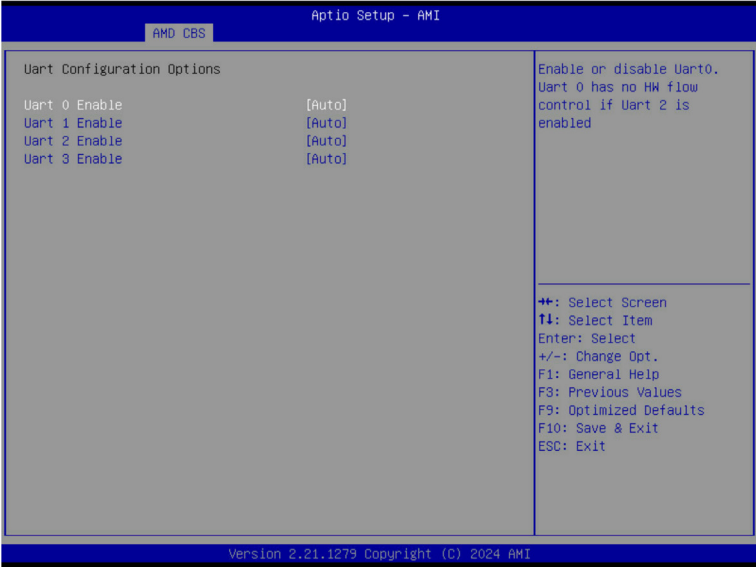

Parameter	Description
Uart Configuration Options	
Uart 0/1/2/3 Enable	Options available: Disabled, Enabled, Auto. Default setting is Auto .

2-3-5-6 ESPI Configuration Options



Parameter	Description
ESPI Configuration Options	
ESPI Enable	Options available: Disabled, Enabled, Auto. Default setting is Auto .

2-3-5-7 FCH RAS Options



Parameter	Description
FCH RAS Options	
ALink RAS Support	Enable/Disable the ALink RAS Support. Options available: Disabled, Enabled, Auto. Default setting is Auto .
Reset after sync flood	Enables AB to forward downstream sync-flood message to system controller. Options available: Enable, Disable, Auto. Default setting is Auto .

2-3-5-8 Miscellaneous Options

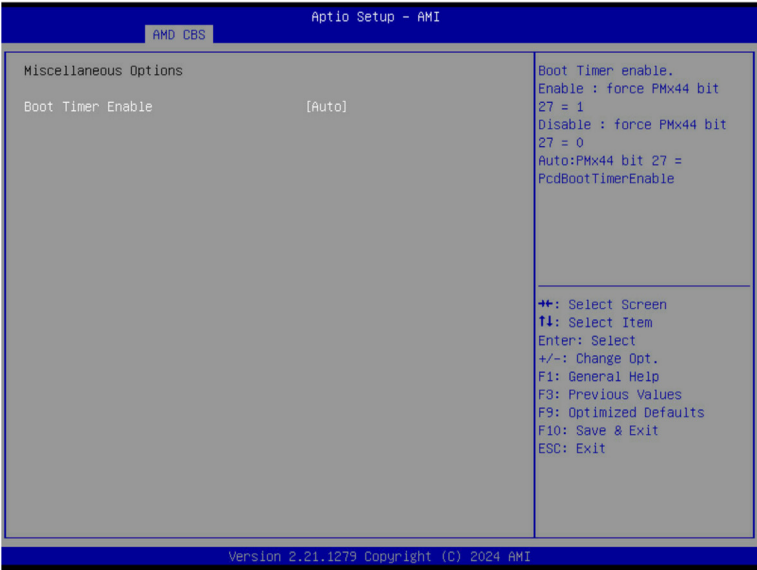

Parameter	Description
Miscellaneous Options	
Boot Timer Enable	Enable/Disable Boot Timer. Options available: Disabled, Enabled, Auto. Default setting is Auto .

2-3-6 SOC Miscellaneous Control

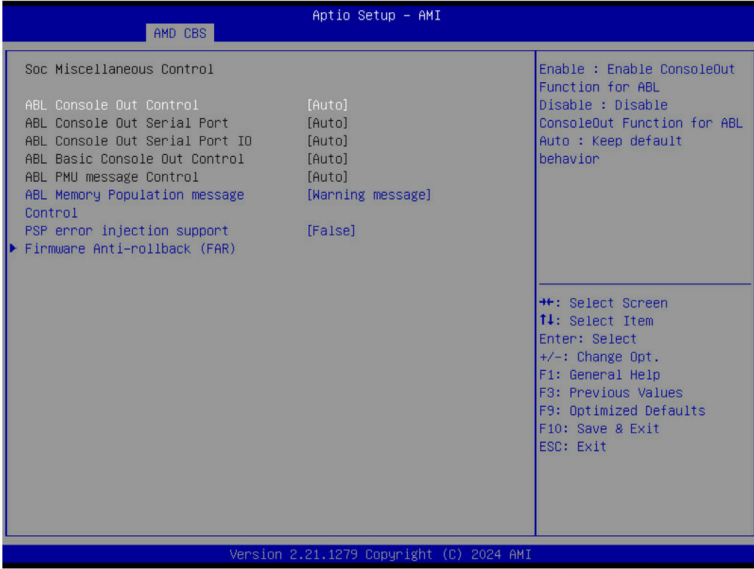

Parameter	Description
SOC Miscellaneous Control	
ABL Console Out Control ^(Note)	Enable/Disable the ConsoleOut function for ABL. Options available: Disable, Enable, Auto. Default setting is Auto .
ABL Console Out Serial Port	Options available: eSPI, SOC UART0, SOC UART1, Auto. Default setting is Auto .
ABL Console Out Serial Port IO	Options available: 0x3F8, 0x2F8, 0x3E8, 0x2E8, Auto. Default setting is Auto .
ABL Basic Console Out Control	Enable/Disable the Basic ConsoleOut function for ABL. Options available: Disable, Enable, Auto. Default setting is Auto .
ABL PMU message Control	To Control the total number of PMU debug messages. Options available: Auto, Detailed debug message, Coarse debug message, Stage completion, Assertion messages, Firmware completion message only. Default setting is Auto .
ABL Memory Population message Control	Options available: Warning message, Fatal error. Default setting is Warning message .
PSP error injection support	Options available: False, True. Default setting is False .

(Note) Advanced items are configurable when this item is defined.

Firmware Anti-rollback (FAR)

Press [Enter] for configuration of advanced items.

- ◆ FAR enforcement state
 - Default setting is **Enabled**.
- ◆ SPL value in the CPU Fuse
- ◆ SPL value in the SPL table
- ◆ FAR Switch
 - Options available: Disabled, Enabled, Auto. Default setting is **Auto**.

2-3-7 CXL Common Options

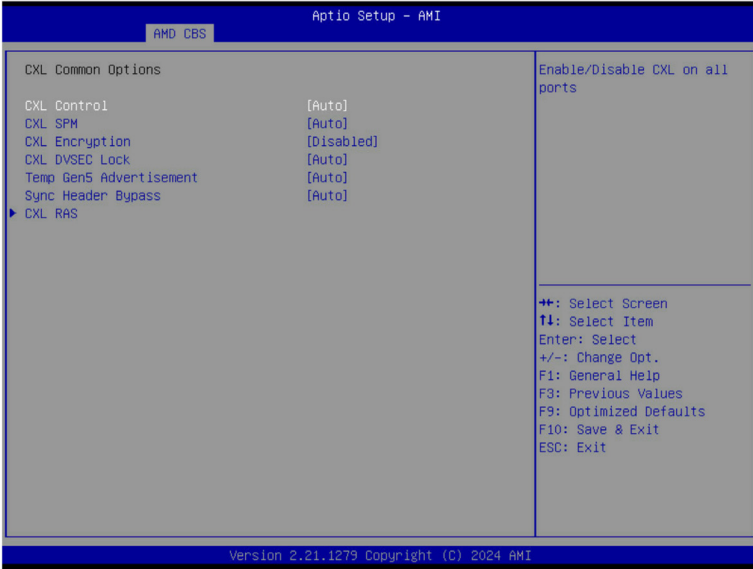

Parameter	Description
CXL Common Options	
CXL Control	Options available: Auto, Enabled, Disabled. Default setting is Auto .
CXL SPM	Options available: Auto, Enabled, Disabled. Default setting is Auto .
CXL Encryption	Options available: Enabled, Disabled. Default setting is Disabled .
CXL DVSEC Lock	Options available: Auto, Enabled, Disabled. Default setting is Auto .
Temp Gen5 Advertisement	Options available: Disabled, Enabled, Auto. Default setting is Auto .
Sync Header Bypass	Options available: Auto, Enabled, Disabled. Default setting is Auto .
CXL RAS	<p>Press [Enter] for configuration of advanced items.</p> <ul style="list-style-type: none"> ◆ CXL Protocol Error Reporting <ul style="list-style-type: none"> – Options available: Disabled, SameAsPcieAer, ForceAerFwFirstIfCxlPresent. Default setting is SameAsPcieAer. ◆ CXL Component Error Reporting <ul style="list-style-type: none"> – Options available: OS First, FW-First. Default setting is FW-First.

2-4 AMD PBS Menu

AMD PBS Option menu displays submenu options for configuring the function of AMD PBS. Select a submenu item, then press [Enter] to access the related submenu screen.



Parameter	Description
RAS	Press [Enter] for configuration of advanced items.
SPI Locking	Enable/Disable SPI Locking for protect ROM part. Options available: Disabled, Enabled. Default setting is Disabled .

2-4-1 RAS

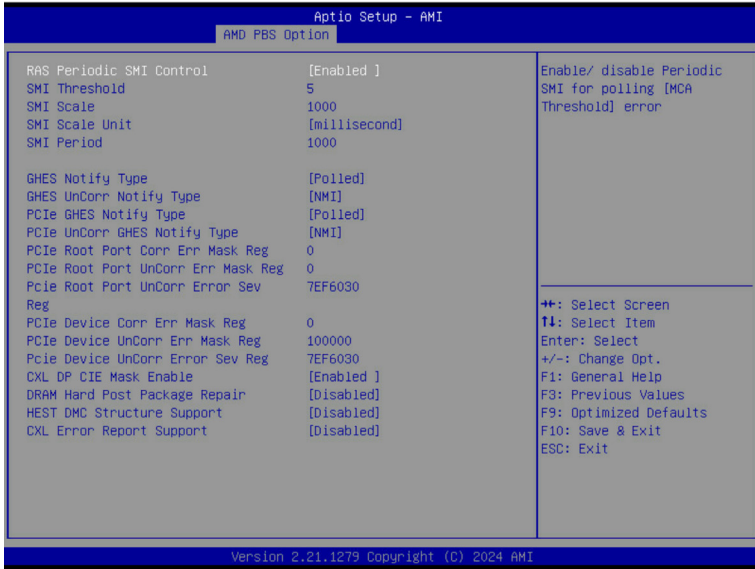

Parameter	Description
RAS Periodic SMI Control	Enable/Disable the Periodic SMI for polling [MCA Threshold] error. Options available: Disabled, Enabled. Default setting is Enabled .
SMI Threshold	Configures the SMI Threshold value.
SMI Scale	Configures the SMI Scale value.
SMI Scale Unit	Defines the unit of time scale. Options available: millisecond, second, minute. Default setting is millisecond .
SMI Period	Configures the SMI Period.
GHES Notify Type	Selects the Notification type for deferred/ corrected errors. Options available: Polled, SCI. Default setting is Polled .
GHES UnCorr Notify Type	Selects the Notification type for uncorrected errors. Options available: Polled, NMI. Default setting is NMI .
PCIe GHES Notify Type	Selects the Notification type for PCIe corrected errors. Options available: Polled, SCI. Default setting is Polled .
PCIe UnCorr GHES Notify Type	Selects the Notification type for PCIe uncorrected errors. Options available: Polled, NMI. Default setting is NMI .
PCIe Root Port Corr Err Mask Reg	Initialize the PCIe AER Corrected Error Mask register of Root Port.

Parameter	Description
PCIe Root Port UnCorr Err Mask Reg	Initialize the PCIe AER Uncorrected Error Mask register of Root Port.
PCIe Root Port UnCorr Err Sev Reg	Initialize the PCIe AER Uncorrected Error Severity register of Root Port.
PCIe Device Corr Err Mask Reg	Initialize the PCIe AER Corrected Error Mask register of PCIe device.
PCIe Device UnCorr Err Mask Reg	Initialize the PCIe AER Uncorrected Error Mask register of PCIe device.
PCIe Device UnCorr Err Sev Reg	Initialize the PCIe AER Uncorrected Error Severity register of PCIe device.
DRAM Hard Post Package Repair	This feature allows spare DRAM rows to replace malfunctioning rows via an in-field repair mechanism. Options available: Disabled, Enabled. Default setting is Disabled .
HEST DMC Structure Support	HEST DMC (Deferred Machine Check) Structure Support. Options available: Disabled, Enabled. Default setting is Disabled .
CXL Error Report Support	Enable/Disable CXL Error Reporting. Options available: Disabled, Enabled. Default setting is Disabled .

2-5 Chipset Setup Menu

Chipset Setup menu displays submenu options for configuring the function of the North Bridge. Select a submenu item, then press <Enter> to access the related submenu screen.

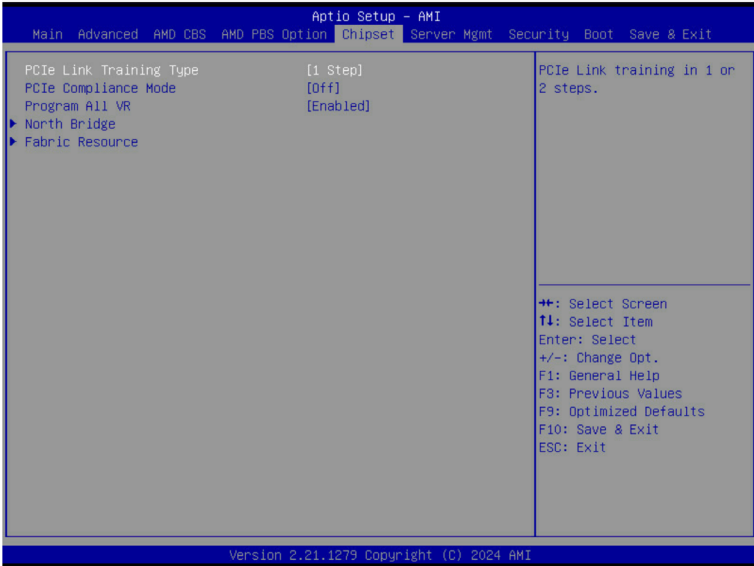

Parameter	Description
PCIe Link Training Type	Options available: 1 Step, 2 Step. Default setting is 1 Step .
PCIe Compliance Mode	Options available: Off, On. Default setting is Off .
Program All VR	Enable/Disable program all VR on MB. Options available: Disabled, Enabled. Default setting is Enabled .
North Bridge	Press [Enter] for configuration of advanced items.
Fabric Resource	Press [Enter] for configuration of advanced items.

2-5-1 North Bridge

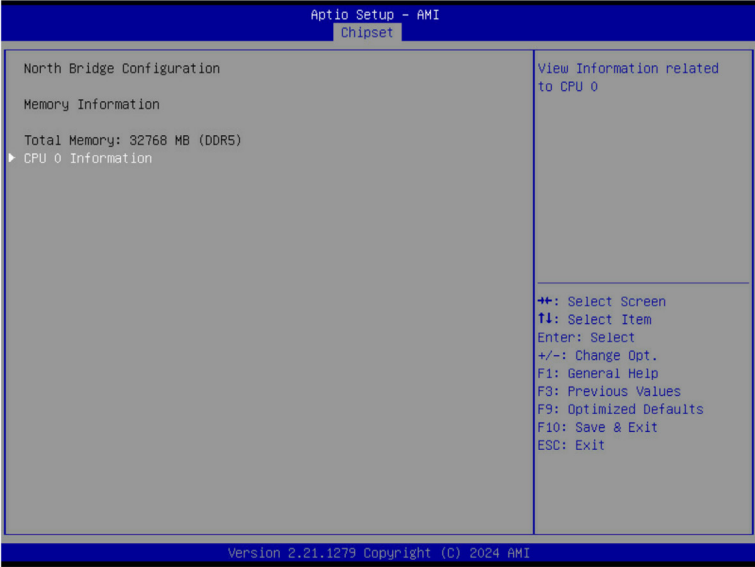

Parameter	Description
North Bridge Configuration	
Memory Information	
Total Memory	Displays the total memory information.
CPU 0 Information	Press [Enter] to view information related to CPU 0.

2-5-2 Fabric Resource

Aptio Setup - AMI
Chipset

Fabric Resource

CPU0 NBI00:
Base Bus: 0xC0
Prefetchable Mmio Above 4G Size: 0 GB
IO Resource: 0x0
PCIe Bus Number 40
Prefetchable Mmio Above 4G size [System Default]
PCIe IO Resource FFFF

CPU0 NBI01:
Base Bus: 0x80
Prefetchable Mmio Above 4G Size: 0 GB
IO Resource: 0x0
PCIe Bus Number 40
Prefetchable Mmio Above 4G size [System Default]
PCIe IO Resource FFFF

CPU0 NBI02:
Base Bus: 0x00
Prefetchable Mmio Above 4G Size: 0 GB
IO Resource: 0x0
PCIe Bus Number 40
Prefetchable Mmio Above 4G size [System Default]
PCIe IO Resource FFFF

Change CPU0 NBI00 PCIe bus number

↑
↓

++: Select Screen
↑↓: Select Item
Enter: Select
+/-: Change Opt.
F1: General Help
F3: Previous Values
F9: Optimized Defaults
F10: Save & Exit
ESC: Exit

Version 2.21.1279 Copyright (C) 2024 AMI

Aptio Setup - AMI
Chipset

CPU0 NBI01:
Base Bus: 0x80
Prefetchable Mmio Above 4G Size: 0 GB
IO Resource: 0x0
PCIe Bus Number 40
Prefetchable Mmio Above 4G size [System Default]
PCIe IO Resource FFFF

CPU0 NBI02:
Base Bus: 0x00
Prefetchable Mmio Above 4G Size: 0 GB
IO Resource: 0x0
PCIe Bus Number 40
Prefetchable Mmio Above 4G size [System Default]
PCIe IO Resource FFFF

CPU0 NBI03:
Base Bus: 0x40
Prefetchable Mmio Above 4G Size: 0 GB
IO Resource: 0x0
PCIe Bus Number 40
Prefetchable Mmio Above 4G size [System Default]
PCIe IO Resource FFFF

Change CPU0 NBI03 PCIe IO Resource

↑
↓

++: Select Screen
↑↓: Select Item
Enter: Select
+/-: Change Opt.
F1: General Help
F3: Previous Values
F9: Optimized Defaults
F10: Save & Exit
ESC: Exit

Version 2.21.1279 Copyright (C) 2024 AMI

Parameter	Description
Fabric Resource	
CPU 0 NBIO_# PCIe Bus Number	Change CPU 0 NBIO_# PCIe Bus Number.
Prefetchable Mmio Above 4G size	Change CPU 0/1 NBIO_# Prefetchable MMIO Above 4G Size. Options available: System Default, 0, 1G, 2G, 4G, 8G, 16G, 32G, 64G, 128G, 256G, 512G, 1T, 2T, 4T, 8T. Default setting is System Default .
PCIe IO Resource	Change CPU 0 NBIO_# PCIe IO Resource.

2-6 Server Management Menu

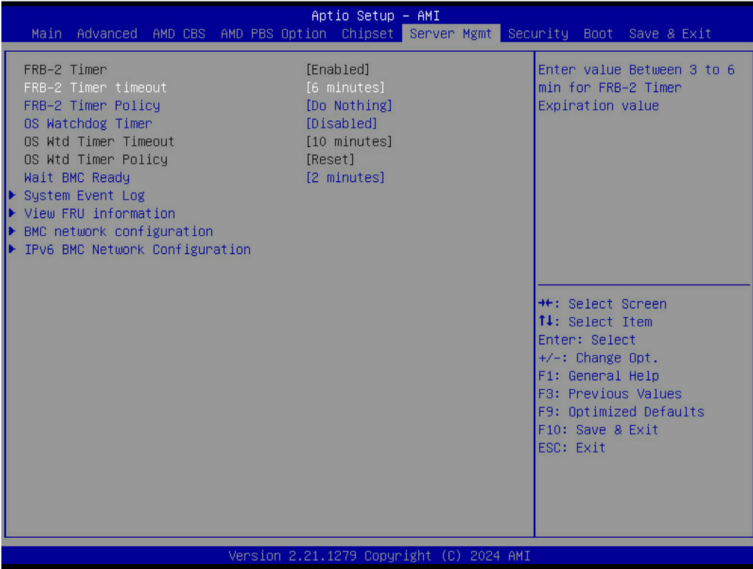

Parameter	Description
FRB-2 Timer	Enable/Disable FRB-2 timer (POST timer). Default setting is Enabled .
FRB-2 Timer timeout	Configures the FRB2 Timer timeout. Options available: 3 minutes, 4 minutes, 5 minutes, 6 minutes. Default setting is 6 minutes .
FRB-2 Timer Policy	Configures the FRB2 Timer policy. Options available: Do Nothing, Reset, Power Down, Power Cycle. Default setting is Do Nothing .
OS Watchdog Timer	Enable/Disable OS Watchdog Timer function. Options available: Enabled, Disabled. Default setting is Disabled .
OS Wtd Timer Timeout ^(Note)	Configures OS Watchdog Timer. Options available: 5 minutes, 10 minutes, 15 minutes, 20 minutes. Default setting is 10 minutes .
OS Wtd Timer Policy ^(Note)	Configure OS Watchdog Timer Policy. Options available: Do Nothing, Reset, Power Down, Power Cycle. Default setting is Reset .
Wait BMC Ready	Post wait BMC ready and reboot system. Options available: Disabled, 2 minutes, 4 minutes, 6 minutes. Default setting is 2 minutes .

(Note) This item is configurable when **OS Watchdog Timer** is set to **Enabled**.

Parameter	Description
System Event Log	Press [Enter] to configure advanced items.
View FRU Information	Press [Enter] to view the FRU information.
BMC network configuration	Press [Enter] to configure advanced items.
IPv6 BMC Network Configuration	Press [Enter] to configure advanced items.

2-6-1 System Event Log

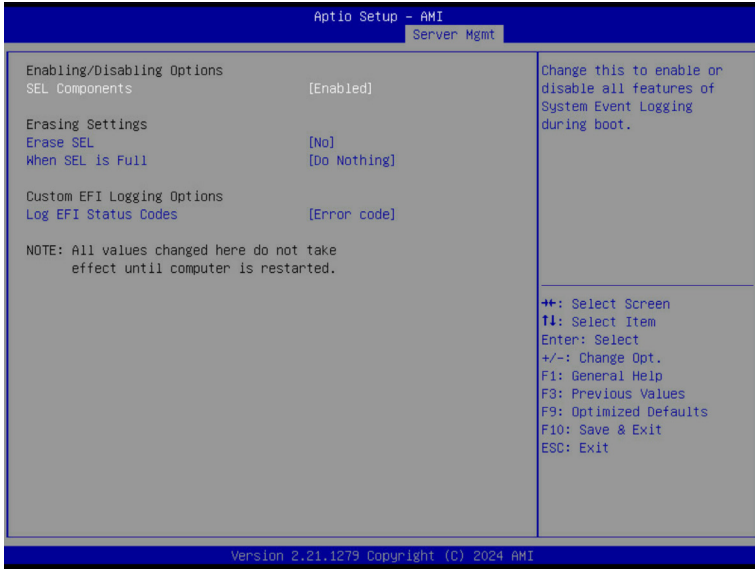

Parameter	Description
Enabling / Disabling Options	
SEL Components	Change this item to enable or disable all features of System Event Logging during boot. Options available: Disabled, Enabled. Default setting is Enabled .
Erasing Settings	
Erase SEL	Choose options for erasing SEL. Options available: No/Yes, On next reset/Yes, On every reset. Default setting is No .
When SEL is Full	Choose options for reactions to a full SEL. Options available: Do Nothing, Erase Immediately. Default setting is Do Nothing .
Custom EFI Logging Options	
Log EFI Status Codes	Enable/Disable the logging of EFI Status Codes (if not already converted to legacy). Options available: Disabled, Both, Error code, Progress code. Default setting is Error code .

2-6-2 View FRU Information

The FRU page is a simple display page for basic system ID information, as well as System product information. Items on this window are non-configurable.

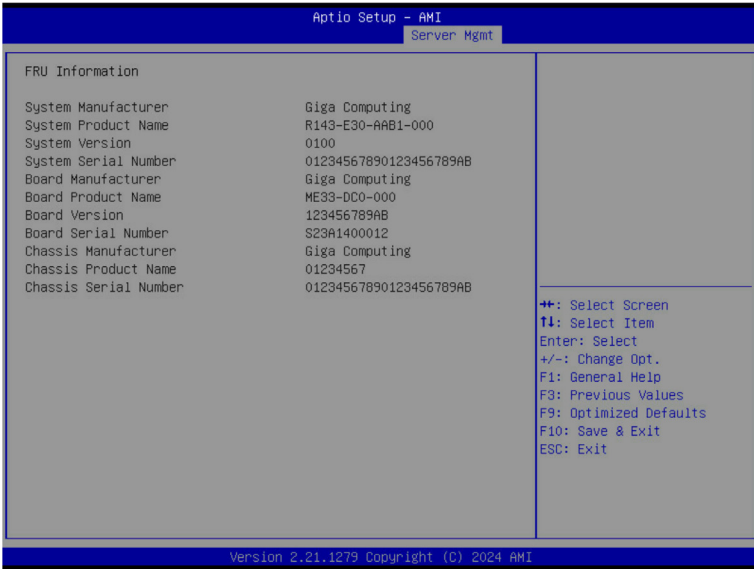

(Note) The model name will vary depends on the product you purchased

2-6-3 BMC Network Configuration

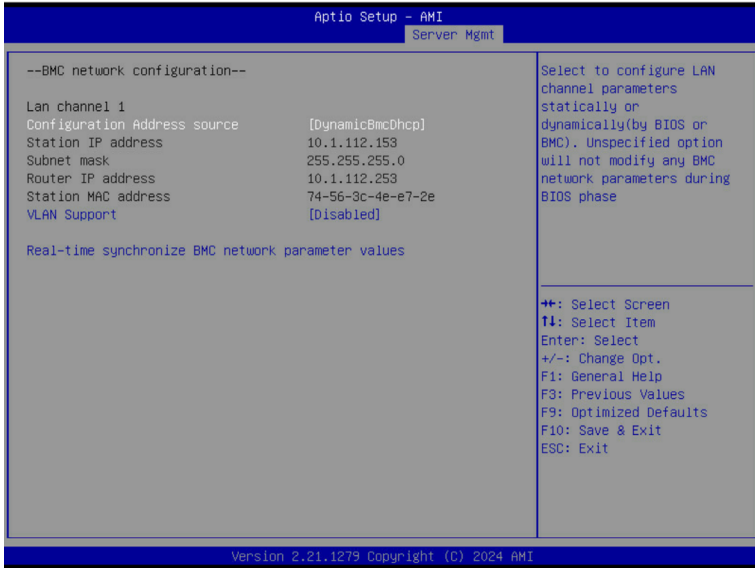

Parameter	Description
BMC network configuration	
Lan Channel 1	
Configuration Address source	Selects to configure LAN channel parameters statically or dynamically (DHCP). Do nothing option will not modify any BMC network parameters during BIOS phase. Options available: Unspecified, Static, DynamicBmcDhcp. Default setting is DynamicBmcDhcp .
Station IP address	Displays IP Address information.
Subnet mask	Displays Subnet Mask information. Please note that the IP address must be in three digitals, for example, 192.168.000.001.
Router IP address	Displays the Router IP Address information.
Station MAC address	Displays the MAC Address information.
VLAN Support	Set BMC to enable/disable VLAN support. Options available: Enabled, Disabled. Default setting is Disabled .
Real-time synchronize BMC network parameter values	Press [Enter] will set Address source(Static/DHCP) to BMC and then get Station IP address, Subnet mask and Router IP address from BMC.

2-6-4 IPv6 BMC Network Configuration

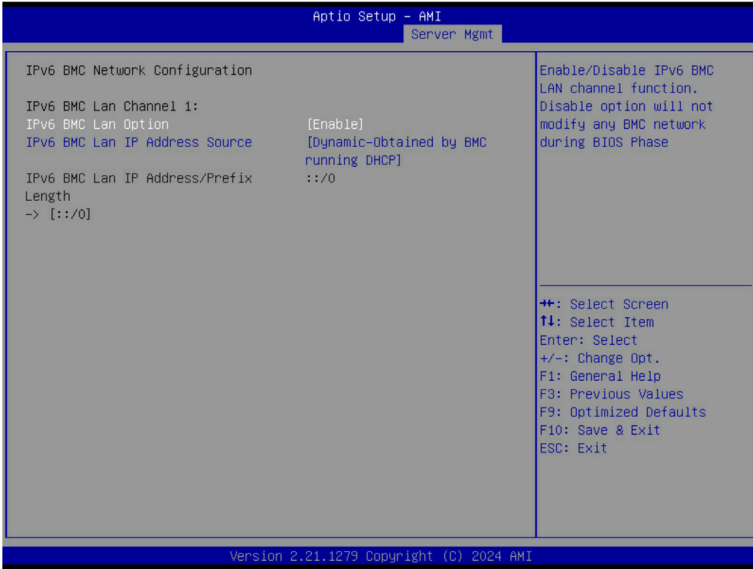

Parameter	Description
IPv6 BMC network configuration	
IPv6 BMC Lan Channel 1	
IPv6 BMC Lan Option	Enable/Disable IPv6 BMC LAN channel function. When this item is disabled, the system will not modify any BMC network during BIOS phase. Options available: Unspecified, Disable, Enable. Default setting is Enable .
IPv6 BMC Lan IP Address Source	Selects to configure LAN channel parameters statically or dynamically (by BIOS or BMC). Options available: Unspecified, Static, Dynamic-Obtained by BMC running DHCP. Default setting is Dynamic-Obtained by BMC running DHCP .
IPv6 BMC Lan IP Address/Prefix Length	Check if the IPv6 BMC LAN IP address matches those displayed on the screen.

2-7 Security Menu

The Security menu allows you to safeguard and protect the system from unauthorized use by setting up access passwords.

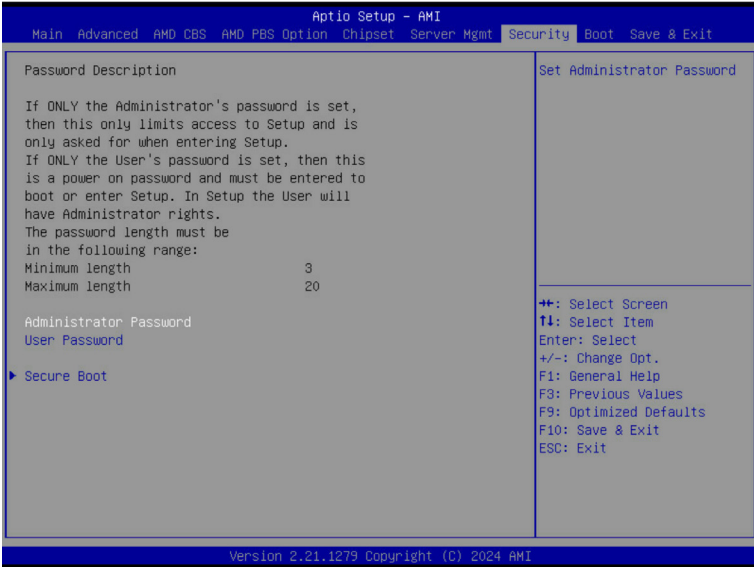

There are two types of passwords that you can set:

- Administrator Password
Entering this password will allow the user to access and change all settings in the Setup Utility.
- User Password
Entering this password will restrict a user's access to the Setup menus. To enable or disable this field, a Administrator Password must first be set. A user can only access and modify the System Time, System Date, and Set User Password fields.

Parameter	Description
Administrator Password	Press [Enter] to configure the administrator password.
User Password	Press [Enter] to configure the user password.
Secure Boot	Press [Enter] to configure advanced items.

2-7-1 Secure Boot

The Secure Boot feature is applicable if supported by your Operating System. If your Operating System is not supporting Secure Boot, the system will hang when starting the Operating System.



Parameter	Description
System Mode	Displays if the system is in User mode or Setup mode.
Secure Boot	Enable/ Disable the Secure Boot function. Options available: Enabled, Disabled. Default setting is Disabled .
Secure Boot Mode ^(Note)	Secure Boot requires all the applications that are running during the booting process to be pre-signed with valid digital certificates. This way, the system knows all files being loaded before the Operating System loads to the login screen have not been tampered with. When set to Standard, it will automatically load the Secure Boot keys from the BIOS databases. When set to Custom, you can customize the Secure Boot settings and manually load its keys from the BIOS database. Options available: Standard, Custom. Default setting is Standard .
Restore Factory Keys	Forces the system to user mode and installs factory default Secure Boot key database.
Reset To Setup Mode	Press [Enter] to reset the system mode to Setup mode.
Enter Audit Mode	Press [Enter] to set the system mode to audit mode.

(Note) Advanced items prompt when this item is set to **Custom**.

Parameter	Description
Key Management	<p data-bbox="329 156 659 180">Press [Enter] to configure advanced items.</p> <p data-bbox="329 185 936 235">Please note that this item is configurable when Secure Boot Mode is set to Custom.</p> <ul style="list-style-type: none"> <li data-bbox="329 243 946 352">◆ Factory Key Provision <ul style="list-style-type: none"> <li data-bbox="361 266 946 321">– Allows to provision factory default Secure Boot keys when system is in Setup Mode. <li data-bbox="361 326 904 352">– Options available: Enabled, Disabled. Default setting is Disabled. <li data-bbox="329 357 925 431">◆ Restore Factory Keys <ul style="list-style-type: none"> <li data-bbox="361 381 925 404">– Installs all factory default keys. It will force the system in User Mode. <li data-bbox="361 409 606 431">– Options available: Yes, No. <li data-bbox="329 435 904 517">◆ Enroll Efi Image <ul style="list-style-type: none"> <li data-bbox="361 459 904 517">– Press [Enter] to enroll SHA256 hash of the binary into Authorized Signature Database (db). <li data-bbox="329 522 899 572">◆ Secure Boot variable <ul style="list-style-type: none"> <li data-bbox="361 545 899 572">– Displays the current status of the variables used for secure boot. <li data-bbox="329 577 803 682">◆ Platform Key (PK) <ul style="list-style-type: none"> <li data-bbox="361 600 803 627">– Displays the current status of the Platform Key (PK). <li data-bbox="361 631 680 655">– Press [Enter] to configure a new PK. <li data-bbox="361 660 601 682">– Options available: Update. <li data-bbox="329 686 946 823">◆ Key Exchange Keys (KEK) <ul style="list-style-type: none"> <li data-bbox="361 710 946 736">– Displays the current status of the Key Exchange Key Database (KEK). <li data-bbox="361 741 904 796">– Press [Enter] to configure a new KEK or load additional KEK from storage devices. <li data-bbox="361 801 670 823">– Options available: Update, Append. <li data-bbox="329 827 946 964">◆ Authorized Signatures (DB) <ul style="list-style-type: none"> <li data-bbox="361 851 904 878">– Displays the current status of the Authorized Signature Database. <li data-bbox="361 882 946 937">– Press [Enter] to configure a new DB or load additional DB from storage devices. <li data-bbox="361 942 670 964">– Options available: Update, Append. <li data-bbox="329 969 904 1105">◆ Forbidden Signatures (DBX) <ul style="list-style-type: none"> <li data-bbox="361 992 904 1019">– Displays the current status of the Forbidden Signature Database. <li data-bbox="361 1023 893 1078">– Press [Enter] to configure a new dbx or load additional dbx from storage devices. <li data-bbox="361 1083 670 1105">– Options available: Update, Append. <li data-bbox="329 1110 931 1246">◆ Authorized TimeStamps (DBT) <ul style="list-style-type: none"> <li data-bbox="361 1133 931 1160">– Displays the current status of the Authorized TimeStamps Database. <li data-bbox="361 1165 904 1219">– Press [Enter] to configure a new DBT or load additional DBT from storage devices. <li data-bbox="361 1224 670 1246">– Options available: Update, Append. <li data-bbox="329 1251 920 1387">◆ OsRecovery Signatures <ul style="list-style-type: none"> <li data-bbox="361 1274 920 1301">– Displays the current status of the OsRecovery Signature Database. <li data-bbox="361 1306 888 1361">– Press [Enter] to configure a new OsRecovery Signature or load additional OsRecovery Signature from storage devices. <li data-bbox="361 1365 670 1387">– Options available: Update, Append.

2-8 Boot Menu

The Boot menu allows you to set the drive priority during system boot-up. BIOS setup will display an error message if the legacy drive(s) specified is not bootable.

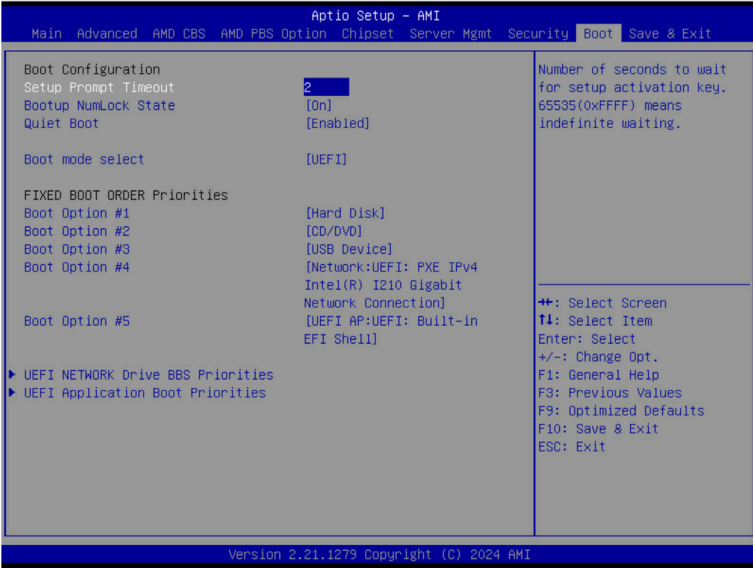

Parameter	Description
Boot Configuration	
Setup Prompt Timeout	Number of seconds to wait for setup activation key. 65535 (0xFFFF) means indefinite waiting. Press the numeric keys to input the desired values.
Bootup NumLock State	Enable/Disable the Bootup NumLock function. Options available: On, Off. Default setting is On .
Quiet Boot	Enable/Disable showing the logo during POST. Options available: Enabled, Disabled. Default setting is Enabled .
Boot mode select	Selects the boot mode. Options available: LEGACY, UEFI. Default setting is UEFI .

Parameter	Description
FIXED BOOT ORDER Priorities	
Boot Option #1 / #2 / #3 / #4 / #5	<p>Press [Enter] to configure the boot priority. By default, the server searches for boot devices in the following sequence:</p> <ol style="list-style-type: none"> 1. Hard drive. 2. CD-COM/DVD drive. 3. USB device. 4. Network. 5. UEFI.
UEFI Hard Disk Drive BBS Priorities	Press [Enter] to configure the boot priority.
UEFI Application Boot Priorities	Press [Enter] to configure the boot priority.

2-9 Save & Exit Menu

The Save & Exit menu displays the various options to quit from the BIOS setup. Highlight any of the exit options then press <Enter>.

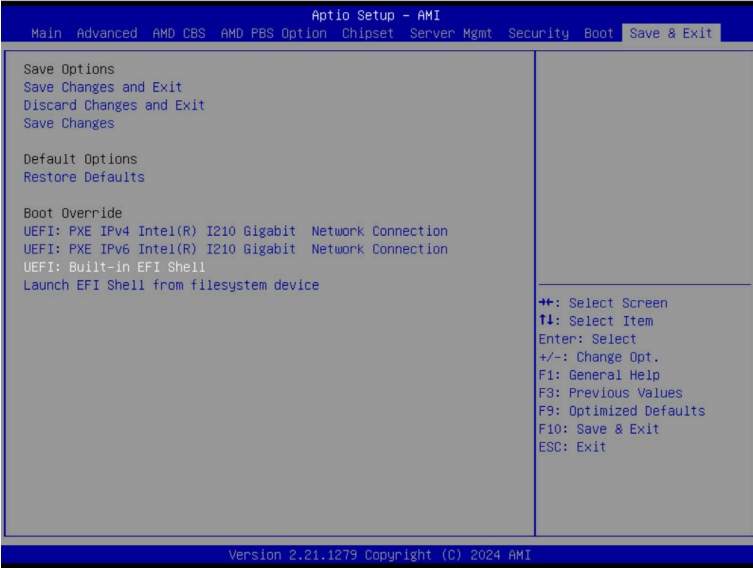

Parameter	Description
Save Options	
Save Changes and Exit	Saves changes made and closes the BIOS setup. Options available: Yes, No.
Discard Changes and Exit	Discards changes made and exits the BIOS setup. Options available: Yes, No.
Save Changes	Saves changes done so far to any of the setup options. Options available: Yes, No.
Default Options	
Restore Defaults	Loads the default settings for all BIOS setup parameters. Setup Defaults are quite demanding in terms of resources consumption. If you are using low-speed memory chips or other kinds of low-performance components and you choose to load these settings, the system might not function properly. Options available: Yes, No.
Boot Override	Press [Enter] to configure the device as the boot-up drive.
Launch EFI Shell from filesystem device	Attempts to Launch EFI Shell application (Shell.efi) from one of the available file system devices.

2-10 BIOS Recovery

The system has an embedded recovery technique. In the event that the BIOS becomes corrupt the boot block can be used to restore the BIOS to a working state. To restore your BIOS, please follow the instructions listed below:

Recovery Instruction:

1. Copy the XXX.rom to USB diskette.
2. Setting BIOS Recovery jump to enabled status.
3. Boot into BIOS recovery.
4. Run Proceed with flash update.
5. BIOS updated.

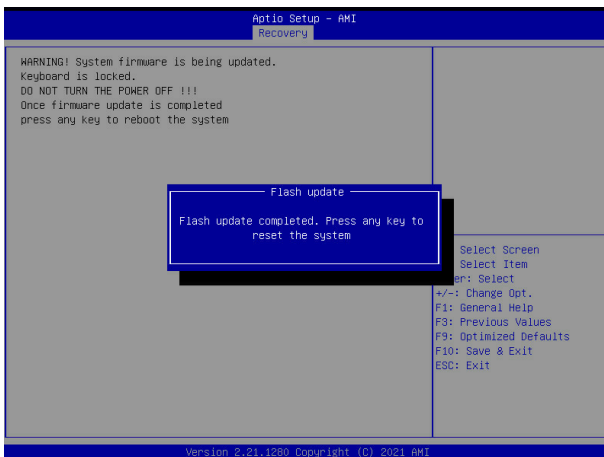
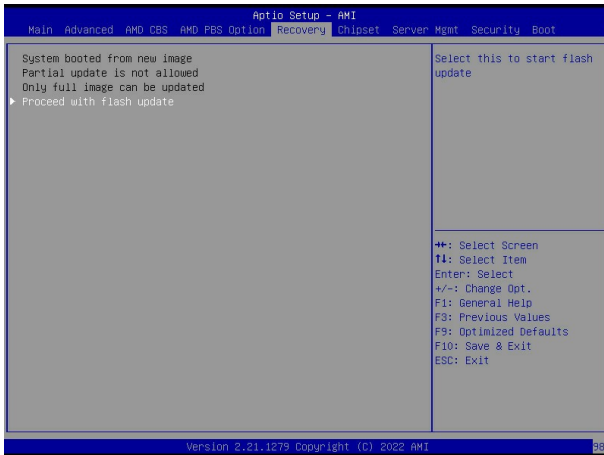

2-11 BIOS POST Beep code (AMI standard)

2-11-1 PEI Beep Codes

# of Beeps	Description
1	Memory not Installed.
1	Memory was installed twice (InstallPeiMemory routine in PEI Core called twice)
2	Recovery started
3	DXE IPL was not found
3	DXE Core Firmware Volume was not found
4	Recovery failed
4	S3 Resume failed
7	Reset PPI is not available

2-11-2 DXE Beep Codes

# of Beeps	Description
1	Invalid password
4	Some of the Architectural Protocols are not available
5	No Console Output Devices are found
5	No Console Input Devices are found
6	Flash update is failed
7	Reset protocol is not available
8	Platform PCI resource requirements cannot be met