

GIGABYTE™

R183-P90-AAJ1

Rack Arm Server - AmpereOne® Family - 1U DP 4-Bay Gen5 NVMe/SATA/SAS-4 Titanium

User Manual

Rev. 1.0

Copyright

© 2024 Giga Computing Technology CO., LTD. All rights reserved.

The trademarks mentioned in this manual are legally registered to their respective owners.

Disclaimer

Information in this manual is protected by copyright laws and is the property of Giga Computing. Changes to the specifications and features in this manual may be made by Giga Computing without prior notice. No part of this manual may be reproduced, copied, translated, transmitted, or published in any form or by any means without Giga Computing's prior written permission.

Documentation Classifications

In order to assist in the use of this product, Giga Computing provides the following types of documentation:

- User Manual: detailed information & steps about the installation, configuration and use of this product (e.g. motherboard, server barebones), covering hardware and BIOS.
- User Guide: detailed information about the installation & use of an add-on hardware or software component (e.g. BMC firmware, rail-kit) compatible with this product.
- Quick Installation Guide: a short guide with visual diagrams that you can reference easily for installation purposes of this product (e.g. motherboard, server barebones).

Please see the support section of the online product page to check the current availability of these documents.

For More Information

For related product specifications, the latest firmware and software, and other information please visit our website at <http://www.gigabyte.com/Enterprise>



For GIGABYTE distributors and resellers, additional sales & marketing materials are available from our reseller portal: <http://reseller.b2b.gigabyte.com>

For further technical assistance, please contact your GIGABYTE representative or visit <https://support.gigabyte.com/> to create a new support ticket

For any general sales or marketing enquiries, you may also message GIGABYTE server directly by email: server.grp@gigabyte.com

Conventions

The following conventions are used in this user's guide:

	NOTE! Gives bits and pieces of additional information related to the current topic.
	CAUTION! Gives precautionary measures to avoid possible hardware or software problems.
	WARNING! Alerts you to any damage that might result from doing or not doing specific actions.

Server Warnings and Cautions

Before installing a server, be sure that you understand the following warnings and cautions.



WARNING!

To reduce the risk of electric shock or damage to the equipment:

- Do not disable the power cord grounding plug. The grounding plug is an important safety feature.
- Plug the power cord into a grounded (earthed) electrical outlet that is easily accessible at all times.
- Unplug all the power cords from the power supplies to disconnect power to the equipment.

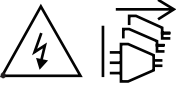

- Shock Hazard! Disconnect all power supply cords before servicing.
- Do not route the power cord where it can be walked on or pinched by items placed against it. Pay particular attention to the plug, electrical outlet, and the point where the cord extends from the server.



WARNING!

To reduce the risk of personal injury from hot surfaces, allow the drives and the internal system components to cool before touching them.



WARNING!

This server is equipped with high speed fans. Keep away from hazardous moving fan blades during servicing.



WARNING!

This equipment is intended to be used in Restrict Access Location. The access can only be gained by Skilled person. Only authorized by well trained professional person can access the restrict access location.



CAUTION!

- Do not operate the server for long periods with the access panel open or removed. Operating the server in this manner results in improper airflow and improper cooling that can lead to thermal damage.
- Danger of explosion if battery is incorrectly replaced.
- Replace only with the same or equivalent type recommended by the manufacturer.
- Dispose of used batteries according to the manufacturer's instructions.



CAUTION!

Risk of explosion if battery is replaced incorrectly or with an incorrect type. Replace the battery only with the same or equivalent type recommended by the manufacturer. Dispose of used batteries according to the manufacturer's instructions.

Electrostatic Discharge (ESD)



CAUTION!

ESD CAN DAMAGE DRIVES, BOARDS, AND OTHER PARTS. WE RECOMMEND THAT YOU PERFORM ALL PROCEDURES AT AN ESD WORKSTATION. IF ONE IS NOT AVAILABLE, PROVIDE SOME ESD PROTECTION BY WEARING AN ANTI-STATIC WRIST STRAP ATTACHED TO CHASSIS GROUND -- ANY UNPAINTED METAL SURFACE -- ON YOUR SERVER WHEN HANDLING PARTS.

Always handle boards carefully. They can be extremely sensitive to ESD. Hold boards only by their edges without any component and pin touching. After removing a board from its protective wrapper or from the system, place the board component side up on a grounded, static free surface. Use a conductive foam pad if available but not the board wrapper. Do not slide board over any surface.

System power on/off: To remove power from system, you must remove the system from rack. Make sure the system is removed from the rack before opening the chassis, adding, or removing any non hot-plug components.

Hazardous conditions, devices and cables: Hazardous electrical conditions may be present on power, telephone, and communication cables. Turn off the system and disconnect the cables attached to the system before servicing it. Otherwise, personal injury or equipment damage can result.

Electrostatic discharge (ESD) and ESD protection: ESD can damage drives, boards, and other parts. We recommend that you perform all procedures in this chapter only at an ESD workstation. If one is not available, provide some ESD protection by wearing an antistatic wrist strap attached to chassis ground (any unpainted metal surface on the server) when handling parts.

ESD and handling boards: Always handle boards carefully. They can be extremely sensitive to electrostatic discharge (ESD). Hold boards only by their edges. After removing a board from its protective wrapper or from the system, place the board component side up on a grounded, static free surface. Use a conductive foam pad if available but not the board wrapper. Do not slide board over any surface.

Installing or removing jumpers: A jumper is a small plastic encased conductor that slips over two jumper pins. Some jumpers have a small tab on top that can be gripped with fingertips or with a pair of fine needle nosed pliers. If the jumpers do not have such a tab, take care when using needle nosed pliers to remove or install a jumper; grip the narrow sides of the jumper with the pliers, never the wide sides. Gripping the wide sides can damage the contacts inside the jumper, causing intermittent problems with the function controlled by that jumper. Take care to grip with, but not squeeze, the pliers or other tool used to remove a jumper, or the pins on the board may bend or break.



WARNING!

The equipment should only be repaired, maintained or replaced by skilled personnel.

Table of Contents

Chapter 1 Hardware Installation	10
1-1 Installation Precautions	10
1-2 Product Specifications	11
1-3 System Block Diagram	15
Chapter 2 System Appearance	16
2-1 Front View	16
2-2 Rear View	17
2-3 Front Panel LEDs and Buttons	18
2-3-1 RoT LEDs	19
2-4 Rear System LAN LEDs	21
2-5 Power Supply Unit (PSU) LED	22
2-6 Hard Disk Drive LEDs	23
Chapter 3 System Hardware Installation	24
3-1 Removing Chassis Cover	25
3-2 Removing and Installing the Fan Duct	26
3-3 Removing and installing the Heat Sink	27
3-4 Installing the CPU	28
3-5 Installing the Memory	30
3-5-1 Eight Channel Memory Configuration	30
3-5-2 Installing the Memory	31
3-5-3 DIMM Population Table	32
3-5-4 Processor and Memory Module Matrix Table	32
3-6 Installing the PCI Expansion Card	33
3-7 Installing the Mezzanine Card	34
3-7-1 OCP 3.0	34
3-8 Installing the Hard Disk Drive	35
3-9 Installing the M.2 Device and Heat Sink	37
3-9-1 M.2 device with Heatsink	37
3-10 Replacing the Fan Assembly	38
3-11 Replacing the Power Supply	39
3-12 Removing the LAN Cable	40
3-13 Cable Routing	41
Chapter 4 Motherboard Components	43

4-1	Motherboard Components	43
4-2	Jumper Setting	45
4-3	G-SC Module	46
4-3-1	CDCR115	46
4-4	Backplane Board Storage Connector	47
4-4-1	CBP1048	47
Chapter 5 BIOS Setup		48
5-1	The Main Menu	50
5-2	Advanced Menu	53
5-2-1	Trusted Computing	54
5-2-2	S5 RTC Wake Settings	55
5-2-3	UEFI Variables Protection	56
5-2-4	Serial Port Console Redirection	57
5-2-5	PCI Subsystem Settings	59
5-2-6	Info Report Configuration	61
5-2-7	USB Configuration	62
5-2-8	Network Stack Configuration	63
5-2-9	NVMe Configuration	64
5-2-10	SATA Configuration	65
5-2-11	Graphic Output Configuration	66
5-2-12	Power Restore Configuration	67
5-2-13	Tls Auth Configuration	68
5-2-14	Intel(R) I350 Gigabit Network Connection	69
5-2-15	MAC IPv4 Network Configuration	71
5-2-16	MAC IPv6 Network Configuration	72
5-2-17	RAM Disk Configuration	73
5-2-18	Driver Health	74
5-3	Chipset Setup Menu	75
5-3-1	Memory Configuration	76
5-3-2	CPU Configuration	77
5-3-3	ACPI Configuration	78
5-3-4	PCIE Device Configuration	79
5-3-5	PCIE Root Complex Configuration	80
5-3-6	Power Policy	81
5-4	Server Management Menu	82
5-4-1	System Event Log	84
5-4-2	View FRU Information	85
5-4-3	Bmc self test log	86
5-4-4	BMC VLAN Configuration	87

5-4-5	BMC Network Configuration	88
5-4-6	IPv6 BMC Network Configuration	89
5-5	Security Menu	90
5-5-1	Secure Boot	91
5-6	Boot Menu	94
5-7	Save & Exit Menu	96
5-8	BIOS Recovery	98
5-9	BIOS POST Beep code (AMI standard)	99
5-9-1	PEI Beep Codes	99
5-9-2	DXE Beep Codes	99

Chapter 1 Hardware Installation

1-1 Installation Precautions

The motherboard/system contain numerous delicate electronic circuits and components which can become damaged as a result of electrostatic discharge (ESD). Prior to installation, carefully read the service guide and follow these procedures:

- Prior to installation, do not remove or break motherboard S/N (Serial Number) sticker or warranty sticker provided by your dealer. These stickers are required for warranty validation.
- Always remove the AC power by unplugging the power cord from the power outlet before installing or removing the motherboard or other hardware components.
- When connecting hardware components to the internal connectors on the motherboard, make sure they are connected tightly and securely.
- When handling the motherboard, avoid touching any metal leads or connectors.
- It is best to wear an electrostatic discharge (ESD) wrist strap when handling electronic components such as a motherboard, CPU or memory. If you do not have an ESD wrist strap, keep your hands dry and first touch a metal object to eliminate static electricity.
- Prior to installing the motherboard, please have it on top of an antistatic pad or within an electrostatic shielding container.
- Before unplugging the power supply cable from the motherboard, make sure the power supply has been turned off.
- Before turning on the power, make sure the power supply voltage has been set according to the local voltage standard.
- Before using the product, please verify that all cables and power connectors of your hardware components are connected.
- To prevent damage to the motherboard, do not allow screws to come in contact with the motherboard circuit or its components.
- Make sure there are no leftover screws or metal components placed on the motherboard or within the computer casing.
- Do not place the computer system on an uneven surface.
- Do not place the computer system in a high-temperature environment.
- Turning on the computer power during the installation process can lead to damage to system components as well as physical harm to the user.
- If you are uncertain about any installation steps or have a problem related to the use of the product, please consult a certified computer technician.





1-2 Product Specifications



NOTE:

We reserve the right to make any changes to the product specifications and product-related information without prior notice.

	System Dimension	<ul style="list-style-type: none"> ◆ 1U ◆ 438 x 43.5 x 815 (W x H x D, mm)
	CPU	<ul style="list-style-type: none"> ◆ AmpereOne® Family Processors ◆ Up to 192 custom cores per processor ◆ Dual processor, TDP up to 400W <p>[Note] If only 1 CPU is installed, some PCIe or memory functions might be unavailable.</p>
	Socket	<ul style="list-style-type: none"> ◆ 2 x LGA 5964
	Chipset	<ul style="list-style-type: none"> ◆ System on Chip
	Security	<ul style="list-style-type: none"> ◆ UEFI Secure Boot ◆ Silicon root of trust (Option) ◆ SNMP Support: V3
	Memory	<ul style="list-style-type: none"> ◆ 32 x DIMM slots ◆ DDR5 memory supported only ◆ 8-Channel memory architecture ◆ RDIMM: Up to 5200 MT/s, 4400 MT/s (2R 2DPC)
	LAN	<p>Rear (G-SCM board - CDCR115):</p> <ul style="list-style-type: none"> ◆ 2 x 1Gb/s LAN (1 x Intel® I350-AM2) <ul style="list-style-type: none"> - Support NCSI function ◆ 1 x 10/100/1000 Mbps Management LAN
	Video	<ul style="list-style-type: none"> ◆ Integrated in Aspeed® AST2600 - 1 x Mini-DP
	Storage	<p>Front hot-swap:</p> <ul style="list-style-type: none"> ◆ 4 x 3.5"/2.5" Gen5 NVMe/SATA/SAS-4 ^[1] <ul style="list-style-type: none"> - (2 x NVMe from CPU_0, 2 x NVMe from CPU_1) - (SATA from CPU_1) <p>Internal M.2:</p> <ul style="list-style-type: none"> ◆ 1 x M.2 (2242/2260/2280/22110), PCIe Gen5 x4, from CPU_0 <p>^[1] SAS card is required to support SAS drives.</p>
	SAS	<ul style="list-style-type: none"> ◆ Require SAS add-in cards
	RAID	<ul style="list-style-type: none"> ◆ Require RAID add-in cards

	Expansion Slot	<ul style="list-style-type: none"> ◆ Riser Card CRS101J: <ul style="list-style-type: none"> - 1 x FHHL x16 (Gen5 x16), from CPU_0 ◆ Riser Card CRS101K: <ul style="list-style-type: none"> - 1 x FHHL x16 (Gen5 x16), from CPU_1 ◆ 1 x OCP NIC 3.0 (Gen5 x16), from CPU_0 <ul style="list-style-type: none"> - Supports NCSI function ◆ 1 x OCP NIC 3.0 (Gen5 x16), from CPU_1 <ul style="list-style-type: none"> - Supports NCSI function
	Front I/O	<ul style="list-style-type: none"> ◆ 2 x USB 3.2 Gen1 ports (Type-A) ◆ 1 x Power button with LED ◆ 1 x ID button with LED ◆ 1 x NMI button ◆ 1 x Reset button ◆ 2 x LAN activity LEDs ◆ 1 x Storage activity LED ◆ 1 x System status LED
	Rear I/O	<ul style="list-style-type: none"> ◆ G-SCM board - CDCR115: <ul style="list-style-type: none"> - 2 x USB 3.2 Gen1 ports (Type-A) - 1 x Mini-DP - 2 x RJ45 ports - 1 x MLAN port - 1 x ID LED
	Backplane Board	<ul style="list-style-type: none"> ◆ Speed and bandwidth: PCIe Gen5 x4 or SATA 6Gb/s or SAS-4 24Gb/s
	TPM	<ul style="list-style-type: none"> ◆ 1 x TPM header with SPI interface <ul style="list-style-type: none"> - Optional TPM2.0 kit: CTM010



Power Supply

- ◆ 2 x 2000W 80 PLUS Titanium redundant power supply
 - ◆ AC Input:
 - 100-127V~/ 13A, 50-60Hz
 - 200-220V~/ 10A, 50-60Hz
 - 220-240V~/ 10A, 50-60Hz
 - ◆ DC Input: (Only for China)
 - 240Vdc/ 10A
 - ◆ DC Output:
 - Max 1000W/ 100-127V~
 - +12.2V/ 82A
 - +12.2Vsb/ 3A
 - Max 1800W/ 200-220V~
 - +12.2V/ 148A
 - +12.2Vsb/ 3A
 - Max 2000W/ 220-240V~ or 240Vdc Input
 - +12.2V/ 164A
 - +12.2Vsb/ 3A

[Note] GIGABYTE offers PSUs with various efficiency ratings and power outputs. Full redundancy may depend on your server configuration, and alternative PSU options may be needed. Please contact our sales representatives for the best power solution



System Management

- ◆ Aspeed® AST2600 Baseboard Management Controller
- ◆ GIGABYTE Management Console web interface

- ◆ Dashboard
- ◆ HTML5 KVM
- ◆ Sensor Monitor (Voltage, RPM, Temperature, CPU Status ...etc.)
- ◆ Sensor Reading History Data
- ◆ FRU Information
- ◆ SEL Log in Linear Storage / Circular Storage Policy
- ◆ Hardware Inventory
- ◆ Fan Profile
- ◆ System Firewall
- ◆ Power Consumption
- ◆ Power Control
- ◆ Advanced power capping
- ◆ LDAP / AD / RADIUS Support
- ◆ Backup & Restore Configuration
- ◆ Remote BIOS/BMC/CPLD Update
- ◆ Event Log Filter
- ◆ User Management
- ◆ Media Redirection Settings
- ◆ PAM Order Settings
- ◆ SSL Settings
- ◆ SMTP Settings



Operating Properties

- ◆ Operating temperature: 10°C to 35°C
- ◆ Operating humidity: 8%-80% (non-condensing)
- ◆ Non-operating temperature: -40°C to 60°C
- ◆ Non-operating humidity: 20%-95% (non-condensing)

1-3 System Block Diagram

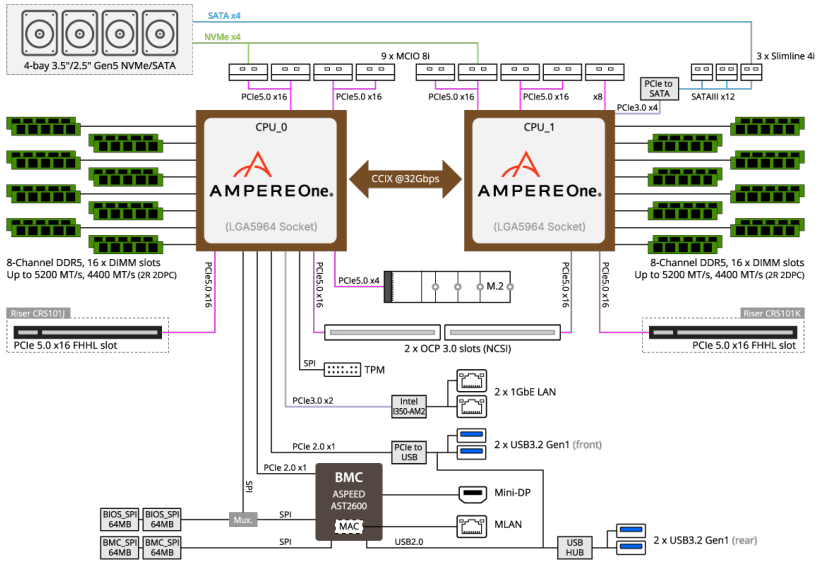

Chapter 2 System Appearance

2-1 Front View

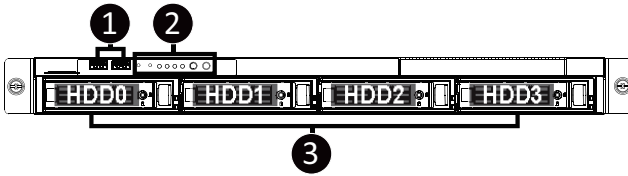

No.	Description
1.	Front USB 3.2 Gen1 Ports
2.	Front Panel LEDs and Buttons
3.	3.5"/2.5" Drive Bays
NOTE! Drives with green latches support NVMe.	



- Please Go to Chapter 2-3 Front Panel LED and Buttons for detail description of function LEDs.

2-2 Rear View

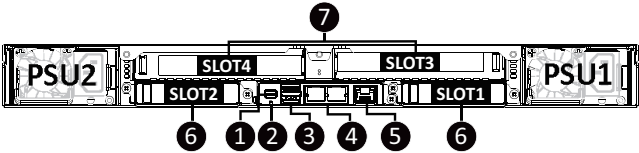

No.	Description
1.	Mini DisplayPort
2.	ID LED
3.	USB 3.2 Gen1 Port x 2
4.	Data LAN Port x 2
5.	Management LAN Port
6.	OCP 3.0 Slot (Option/SFF)
7.	PCIe Card Slot



- Remove the LAN Cable. See 3-12 Removing the LAN Cable on page 40.

2-3 Front Panel LEDs and Buttons

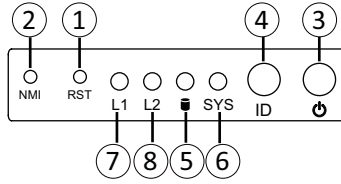

No.	Name	Color	Status	Description
1.	Reset Button			Press the button to reset the system.
2.	NMI button			Press the button server generates a NMI to the processor if the multiple-bit ECC errors occur, which effectively halt the server.
3.	Power button with LED	Green	On	System is powered on
		N/A	Off	System is not powered on or in ACPI S5 state (power off)
4.	ID Button ^(Note)			Press the button to activate system identification
5.	HDD Status LED	Green	On	HDD locate
			Blink	HDD access
		Amber	On	HDD fault
			Blink	HDD rebuilding
		N/A	Off	No HDD access or no HDD fault.
6.	System Status LED ^(Note)	Green	On	System is operating normally.
			Amber	On
		Blink		
			N/A	Off
7/8.	LAN 1/2 Active/Link LEDs	Green	On	Link between system and network or no access.
		Green	Blink	Data transmission or receiving is occurring
		N/A	Off	No data transmission or receiving is occurring

(Note) If your server features RoT function, please see the following section for detail LED behavior.

2-3-1 RoT LEDs

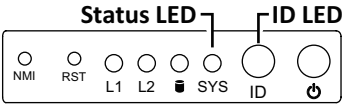

	LED on Front panel ^(Note5)	
	ID LED	Status LED
EC Firmware (FW) Authentication fail or not exit		
EC FW is broken or not exit ^(Note1)	OFF	OFF
Authenticating/Recovering BMC/BIOS Images		
Authenticating Images	OFF	OFF
Recovering BMC Active Flash	Blinks Blue 4 times per second	Blinks Green 4 times per second
Recovering BIOS Active Flash	Blinks Blue 4 times per second	Blinks Green 4 times per second
Authentication (AUTH) Pass		
Recovering BIOS Active Flash	OFF	OFF
BMC : AUTH pass after doing recovery	OFF	OFF
BIOS : AUTH pass after doing recovery	OFF	OFF
BMC : AUTH pass after doing recovery	OFF	OFF
BIOS : AUTH pass	OFF	OFF
BMC : AUTH pass	OFF	OFF
BIOS : AUTH pass after doing recovery	OFF	OFF
Active Flash Authentication (AUTH) Fail		
BMC : AUTH Fail ^(Note2)	Blinks Blue 1 time per second	Blinks Green 1 time per second
BIOS : AUTH fail ^(Note2)	Blinks Blue 1 time per second	Blinks Amber 1 time per second

BMC : AUTH fail after doing recovery^(Note3)	Blinks Blue 2 times per second [ON OFF OFF]	Blinks Green 2 times per second [ON OFF OFF]
BIOS : AUTH fail after doing recovery^(Note3)	Blinks Blue 2 times per second [ON OFF OFF]	Blinks Amber 2 times per second [ON OFF OFF]
Backup Flash Authentication Fail^(Note4)		
BMC : AUTH fail	Blinks Blue 2 times per second [ON OFF ON OFF]	Blinks Green 2 times per second [ON OFF ON OFF]
BIOS : AUTH fail	Blinks Blue 2 times per second [ON OFF ON OFF]	Blinks Amber 2 times per second [ON OFF ON OFF]

NOTE!

1. EC FW is broken or not exited result in Microchip CEC1702 cannot load EC FW for authentication.
2. (1) Authentication fail include below scenarios
Configuration table is missing or modified
Public key is missing or modified
Protected area or signature is modified
Flash empty
3. If active flash is still authentication failed after recovery sequence, Microchip CEC1702 stop the process and showing LED behavior.
4. If backup flash authentication is failed cause by configuration table, public key or protected area is broken. Microchip CEC1702 stop the process and showing LED behavior.
5. Front panel LED is controlled by BMC or Microchip CEC1702. Once Microchip CEC1702 is working(Auth or recovery), the front panel LED is controlled by Microchip CEC1702 and vice versa.

2-4 Rear System LAN LEDs

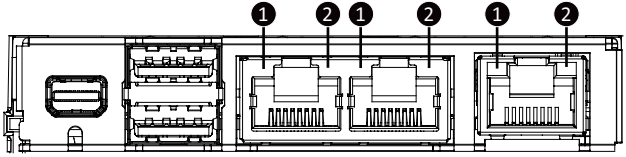

No.	Name	Color	Status	Description
1.	1GbE Speed LED	Yellow	On	1 Gbps data rate
		Green	On	100 Mbps data rate
		N/A	Off	10 Mbps data rate
2.	1GbE Link/ Activity LED	Green	On	Link between system and network or no access
			Blink	Data transmission or receiving is occurring
		N/A	Off	No data transmission or receiving is occurring

2-5 Power Supply Unit (PSU) LED



NOTE!

The power supply may be vary based on the system configuration.

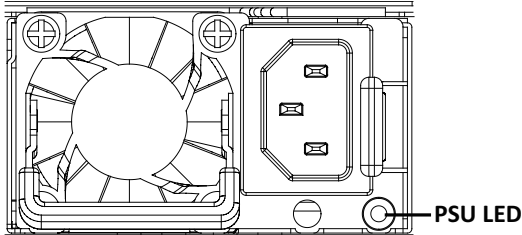

State	Description
OFF	No AC power to all power supplies
1Hz Green Blinking	AC present / only standby on / Cold redundant mode
2Hz Green Blinking	Power supply firmware updating mode
Amber	AC cord unplugged or AC power lost; with a second power supply in parallel still with AC input power
	Power supply critical event causing shut down: failure, OCP, OVP, fan failure and UVP
1Hz Amber Blinking	Power supply warning events where the power supply continues to operate: high temp, high power, high current and slow fan

2-6 Hard Disk Drive LEDs

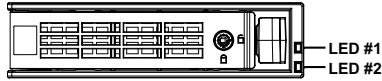

RAID SKU		LED #1	Locate	HDD Fault	Rebuilding	HDD Access	HDD Present (No Access)
No RAID configuration (via PCH, HBA)	Disk LED (LED on Back Panel)	Green	ON(*1)	OFF		BLINK (*2)	OFF
		Amber	OFF	OFF		OFF	OFF
	Removed HDD Slot (LED on Back Panel)	Green	ON(*1)	OFF		--	--
		Amber	OFF	OFF		--	--
RAID configuration (via HW RAID Card or SW RAID Card)	Disk LED	Green	ON	OFF		BLINK (*2)	OFF
		Amber	OFF	ON	(Low Speed: 2 Hz)	OFF	OFF
	Removed HDD Slot	Green	ON(*1)	OFF	(*3)	--	--
		Amber	OFF	ON	(*3)	--	--

LED #2	HDD Present	No HDD
Green	ON	OFF

NOTE:

*1: Depends on HBA/Utility Spec.

*2: Blink cycle depends on HDD's activity signal.

*3: If HDD is pulled out during rebuilding, the disk status of this HDD is regarded as faulty.

Chapter 3 System Hardware Installation



Pre-installation Instructions

Computer components and electronic circuit boards can be damaged by electrostatic discharge. Working on computers that are still connected to a power supply can be extremely dangerous. Follow the simple guidelines below to avoid damage to your computer or injury to yourself.

- Always disconnect the computer from the power outlet whenever you are working inside the computer case.
- If possible, wear a grounded wrist strap when you are working inside the computer case. Alternatively, discharge any static electricity by touching the bare metal system of the computer case, or the bare metal body of any other grounded appliance.
- Hold electronic circuit boards by the edges only. Do not touch the components on the board unless it is necessary to do so. Do not flex or stress the circuit board.
- Leave all components inside the static-proof packaging until you are ready to use the component for the installation.

3-1 Removing Chassis Cover



Before you remove or install the system cover

- Make sure the system is not turned on or connected to AC power.

Follow these instructions to remove the chassis cover:

1. Remove the screws on both sides of the back chassis cover. (Note: For safe shipping, installation screws are added and should be removed before deployment/putting it in the server cabinet.)
2. Remove the screw securing the back chassis cover.
3. Push button to unlock the handle.
4. Pull the grip handle to open the panel cover.
5. Slide the back chassis cover towards the rear and remove the chassis cover in the direction indicated.
6. Remove the screws securing the front chassis cover.
7. Slide the front chassis cover towards the rear and remove the chassis cover in the direction indicated.
8. To reinstall the chassis cover reverse steps 2-7.

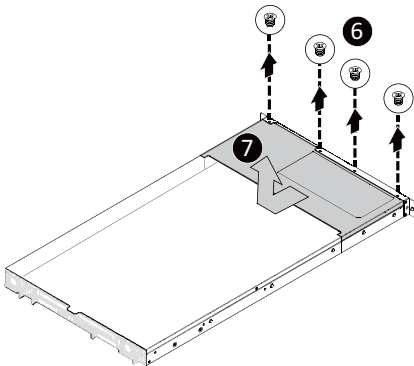
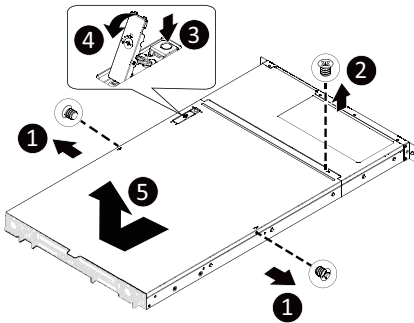

3-2 Removing and Installing the Fan Duct

Follow these instructions to remove/install the fan duct:

1. Lift up to remove the fan duct
2. To install the fan duct, align the fan duct with the guiding groove. Push down the fan duct into chassis until it is firmly seated.

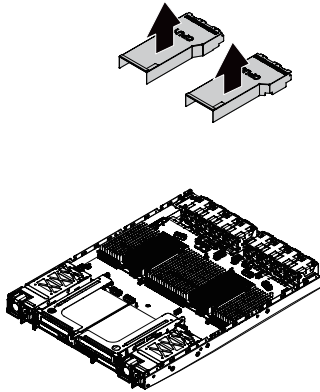

3-3 Removing and installing the Heat Sink



Read the following guidelines before you begin to remove/install the heat sink:

- Always turn off the computer and unplug the power cord from the power outlet before installing the heat sink to prevent hardware damage.
- Unplug all cables from the power outlets.
- Disconnect all telecommunication cables from their ports.
- Place the system unit on a flat and stable surface.
- Open the system according to the instructions.



WARNING!

Failure to turn off the server before you start installing components may cause serious damage. Do not attempt the procedures described in the following sections unless you are a qualified service technician.

Follow these instructions to remove/install the heat sink:

1. Loosen the captive screws securing the heat sink in place in reverse order (4→3→2→1).
2. Lift and remove the heat sink from the system.
3. To reinstall the heat sink reverse steps 1-2 while ensuring that you tighten the captive screws in sequential order (1→2→3→4) as seen in the image below.

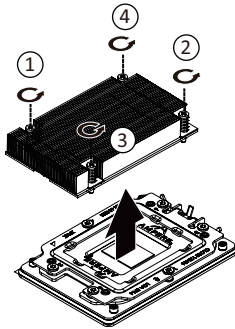

- When installing the heatsink to CPU, use Torx T20 screwdriver to tighten 4 captive nuts in sequence as 1-6.
- The CPU heatsink screw tightening torque: 3 kgf-cm
- ILM and Heat sink for the screw tightening, Tighten the Screw a slight rotations in multiple times until each screw to the desired torque value. Do not fully tighten at once screw.

3-4 Installing the CPU



Read the following guidelines before you begin to install the CPU:

- Make sure that the motherboard supports the CPU.
- Always turn off the computer and unplug the power cord from the power outlet before installing the CPU to prevent hardware damage.
- Unplug all cables from the power outlets.
- Disconnect all telecommunication cables from their ports.
- Place the system unit on a flat and stable surface.
- Open the system according to the instructions.



WARNING!

Failure to properly turn off the server before you start installing components may cause serious damage. Do not attempt the procedures described in the following sections unless you are a qualified service technician.

Follow these instructions to install the CPU:

1. Loosen the six captive screws securing the CPU cover in sequential order (1→2→3→4→5→6).
2. Flip open the CPU cover.
3. Remove the plastic covering on the CPU socket.
4. Align the processor to the carrier so that the gold triangle on the processor aligns with the triangle on the carrier, and then install the processor into the carrier.
NOTE: Apply thermal compound evenly on the top of the CPU.
5. Install the CPU into place in the CPU socket.
NOTE: Save and replace the CPU socket cover if the processor is removed from its socket.
6. Flip the CPU cover into place over the CPU socket.
7. Tighten the CPU cover screw to secure the CPU cover in place.
8. Secure the heatsink by tightening the screws in sequential order (1→2→3→4).

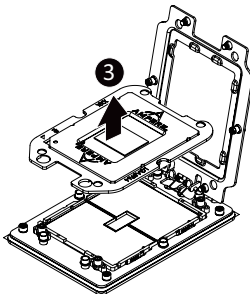
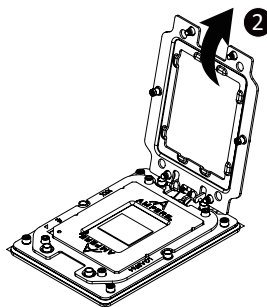
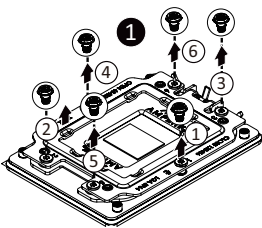

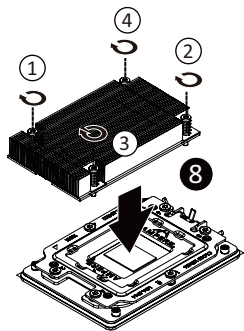
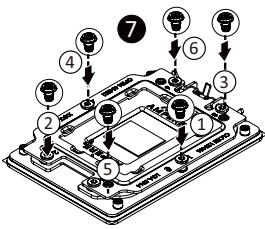
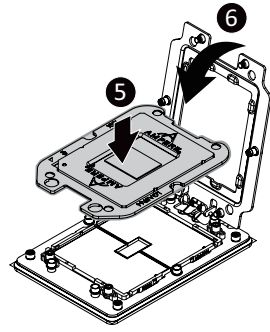
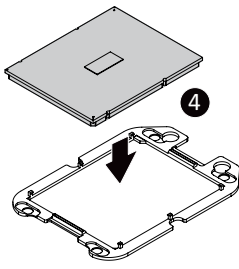

- Lock the CPU by using a Torx T20 screwdriver to tighten screw.
- When installing the heatsink to CPU, use Torx T20 screwdriver to tighten 4 captive nuts in sequence as 1-6.
- The ILM screw tightening torque: 1.5 kgf-cm
- The CPU heatsink screw tightening torque: 3 kgf-cm
- ILM and Heat sink for the screw tightening, Tighten the Screw a slight rotations in multiple times until each screw to the desired torque value. Do not fully tighten at once screw.

3-5 Installing the Memory



Read the following guidelines before you begin to install the memory:

- Make sure that the motherboard supports the memory. It is recommended that memory of the same capacity, brand, speed, and chips be used.
- Always turn off the computer and unplug the power cord from the power outlet before installing the memory to prevent hardware damage.
- Memory modules have a foolproof design. A memory module can be installed in only one direction. If you are unable to insert the memory, switch the direction.

3-5-1 Eight Channel Memory Configuration

This motherboard provides 32 DDR5 memory slots and supports 8-Channel Technology. After the memory is installed, the BIOS will automatically detect the specifications and capacity of the memory.

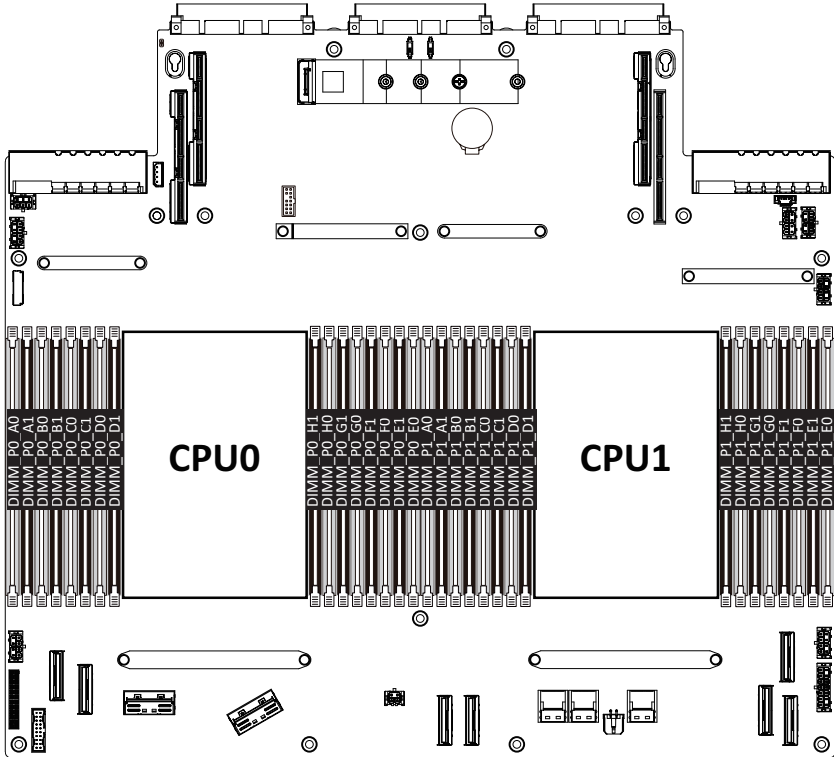

3-5-2 Installing the Memory



Before installing a memory module, make sure to turn off the computer and unplug the power cord from the power outlet to prevent damage to the memory module.

Be sure to install DDR5 DIMMs on this motherboard.

Make sure your DIMM slots have a single latch or a double latch.

Follow these instructions to install a DIMM module with Single Latch :

1. Open the plastic latch of the memory slot, then place the memory module as pre-inserted vertically position.

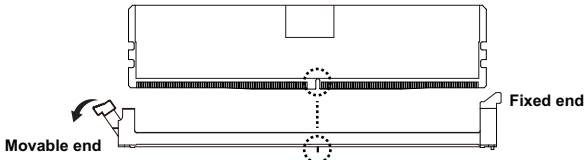

2. Hold it with both hands, insert the memory module into the movable end first, and then insert the memory module into the fixed end.

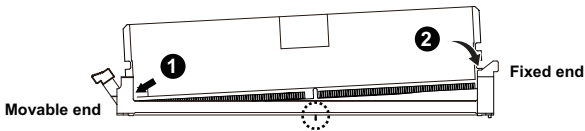

3. Then use both hands to insert the memory module vertically into the DIMM slot and push it down. Close the plastic latch at the edge of the DIMM slots to lock the memory module.

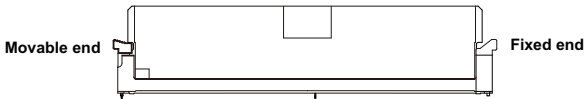

4. Reverse the installation steps when you want to remove the memory module.

Follow these instructions to install a DIMM module with Double Latch:

1. Insert the DIMM memory module vertically into the DIMM slot and push it down.
2. Close the plastic clip at both edges of the DIMM slots to lock the DIMM module.
3. Reverse the installation steps when you want to remove the DIMM module.

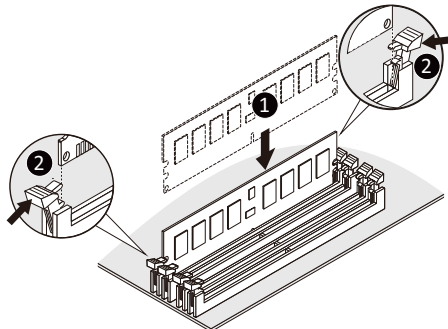

3-5-3 DIMM Population Table

Type	Ranks Per DIMM and Data Width	DIMM Capacity (GB)	Speed (MT/s); Voltage (V); Slots per Channel(SPC) and DIMM per Channel (DPC)		
			1 Slot per Channel	2 Slots per Channel	
		DIMM Density	1DPC	1DPC	2DPC
		16Gb	1.1V	1.1V	1.1V
RDIMM	SRx4	32GB	5200	5200	4400
RDIMM	DRx8	32GB			

3-5-4 Processor and Memory Module Matrix Table

Memory Q'ty for each CPU	CPU0														CPU1																		
	A0	A1	B0	B1	C0	C1	D0	D1	H1	H0	G1	G0	F1	F0	E1	E0	A0	A1	B0	B1	C0	C1	D0	D1	H1	H0	G1	G0	F1	F0	E1	E0	
1 DIMM	v																v																
2 DIMM	v																v	v															v
4 DIMM	v		v											v			v	v	v											v		v	
8 DIMM	v		v		v		v		v		v		v		v		v	v	v	v		v			v		v		v		v		
16 DIMM	v	v	v	v	v	v	v	v	v	v	v	v	v	v	v	v	v	v	v	v	v	v	v	v	v	v	v	v	v	v	v	v	

3-6 Installing the PCI Expansion Card



- Voltages can be present within the server whenever an AC power source is connected. This voltage is present even when the main power switch is in the off position. Ensure that the system is powered-down and all power sources have been disconnected from the server prior to installing a PCIe card.

Failure to observe these warnings could result in personal injury or damage to equipment.



- The PCIe riser assembly does not include a riser card or any cabling as standard. To install a PCIe card, a riser card must be installed.

Follow these instructions for a PCI Expansion card:

1. Loosen the thumbscrew securing the riser bracket.
2. Lift up the riser bracket out of system.
3. Remove the screw securing the slot cover from the riser bracket.
4. Remove the slot covers from the riser bracket.
5. Orient the PCIe card with the riser guide slot and push in the direction of the arrow until the PCIe card sits in the PCIe card connector.
6. Secure the PCIe card with the screw.
7. Reverse the previous steps to install the riser bracket.

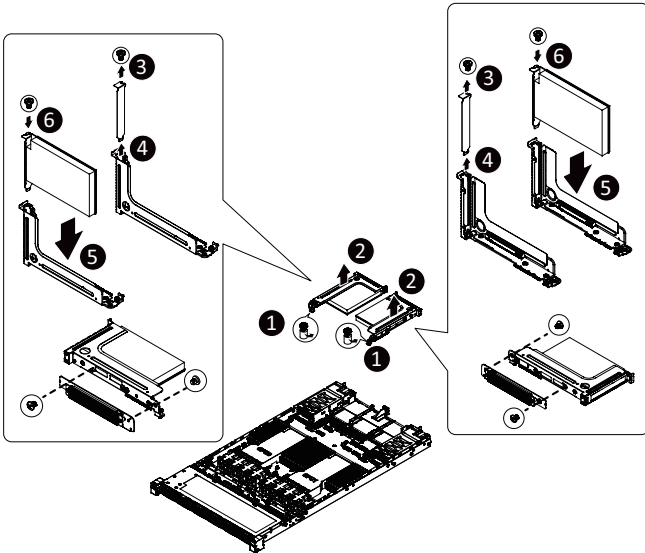

3-7 Installing the Mezzanine Card

3-7-1 OCP 3.0



Use of the following type of OCP 3.0 NIC is recommended:

- OCP 3.0 SFF with Pull Tab
- OCP 3.0 SFF with Ejector Latch

Follow these instructions to install an OCP 3.0 mezzanine card:

1. Remove the two screws securing the mezzanine card slot cover.
2. Remove the slot cover from the system.
3. Insert the OCP 3.0 mezzanine card into the card slot ensuring that the card is firmly connected to the connector on the motherboard.
4. Tighten the thumbnail screw to secure the OCP 3.0 mezzanine card in place.
5. Reverse the previous steps to replace the OCP 3.0 mezzanine card.

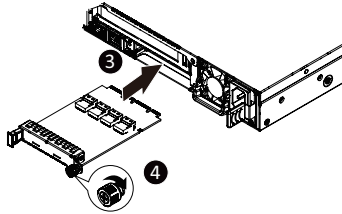
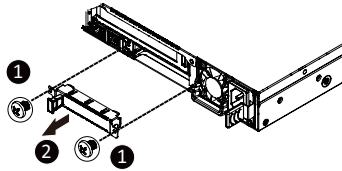

3-8 Installing the Hard Disk Drive



Read the following guidelines before you begin to install the HDD:

- Take note of the drive tray orientation before sliding it out.
- The tray will not fit back into the bay if inserted incorrectly.
- Make sure that the HDD is connected to the HDD connector on the backplane.

Follow these instructions to install a 3.5" HDD:

1. Press the release button.
2. Extend the locking lever.
3. Pull the locking lever in the direction indicated to remove the HDD tray.
4. Align the hard disk drive with the positioning stud on the HDD tray.
5. Slide the hard disk drive into the HDD tray.
6. Reinsert the HDD tray into the slot and close the locking lever.

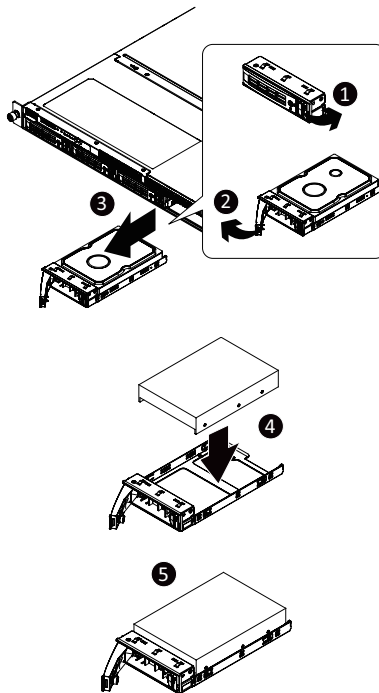

Follow these instructions to install 2.5" hard disk drive into 3.5" HDD Tray:

1. Press the release button.
2. Extend the locking lever.
3. Pull the locking lever in the direction indicated to remove the HDD tray.
4. Align the hard disk drive with the positioning screw on the HDD tray.
5. Secure the hard disk drive with five screws.
6. Reinsert the HDD tray into the slot and close the locking lever.

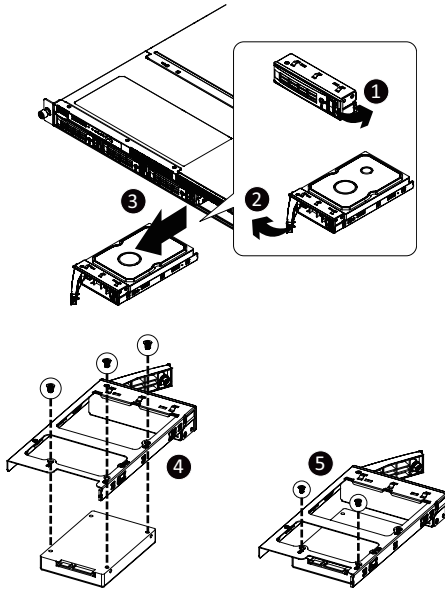

3-9 Installing the M.2 Device and Heat Sink



CAUTION

The position of the stand-off screw will depend on the size of the M.2 device. The stand-off screw is pre-installed for 22110 cards as standard. Refer to the size of the M.2 device and change the position of the stand-off screw accordingly.

Follow these instructions to install the M.2 device:

1. Insert the M.2 SSD module into the slot.
2. Secure it with the screw, tightening as necessary to fasten the M.2 SSD module in place.

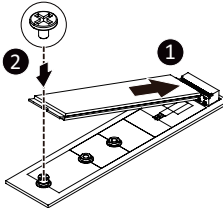

3-9-1 M.2 device with Heatsink



WARNING:

Please ensure a heatsink is attached to any M.2 device installed into the system. Installing an M.2 device without any heatsink may result in the system overheating or system performance being throttled.



- Please Go to [4-1 Motherboard Component](#) for specific M.2 Slot location.
- To install/remove the M.2 module and Heatsink use a No. 1 Phillips-head screwdriver with a screw torque of 1.5 ± 0.2 kg²cm

Follow these instructions to install the M.2 device and heat sink:

1. Insert the M.2 device into the M.2 connector.
2. Press down on the M.2 device.
3. Install the thermal pad of the M.2 device to the M.2 device.
4. Press down on the thermal pad.
5. Secure the M.2 device and its thermal pad to the motherboard with a single screw.
6. Reverse steps 1-2 to remove the M.2 device.

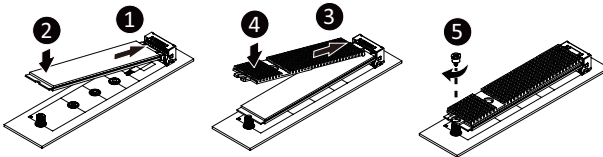

3-10 Replacing the Fan Assembly



- Voltages can be present within the server whenever an AC power source is connected. This voltage is present even when the main power switch is in the off position. Ensure that the system is powered-down and all power sources have been disconnected from the server prior to replacing a system fan.
- Failure to observe these warnings could result in personal injury or damage to equipment.

Follow these instructions to replace the fan assembly:

1. Lift up the fan assembly from the chassis.
2. Reverse the previous steps to install the replacement fan assembly.

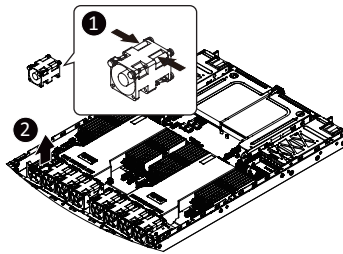

3-11 Replacing the Power Supply



CAUTION!

- In order to reduce the risk of injury from electric shock, disconnect AC power from the power supply before removing the power supply from the system

Follow these instructions to replace the power supply:

1. Flip and then grasp the power supply handle.
2. Press the retaining clip on the top side of the power supply in the direction indicated.
3. Pull out the power supply using the handle.
4. Insert the replacement power supply firmly into the chassis. Connect the AC power cord to the replacement power supply.

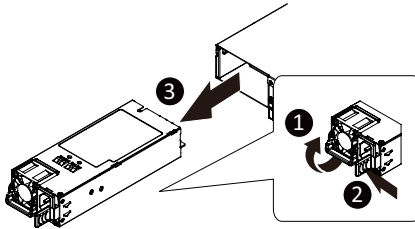

3-12 Removing the LAN Cable

Follow these instructions to remove the LAN cable:

1. Press the release latch while simultaneously pulling out the LAN cable.

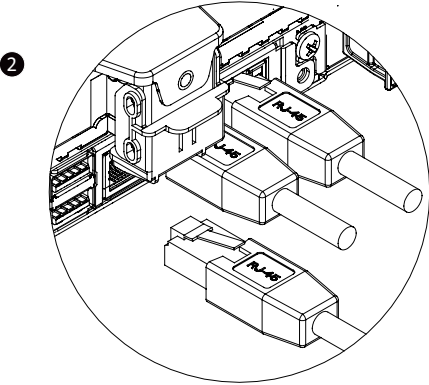
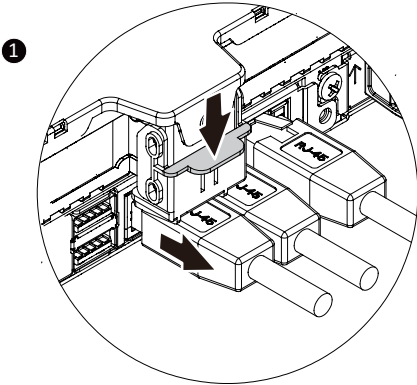

3-13 Cable Routing

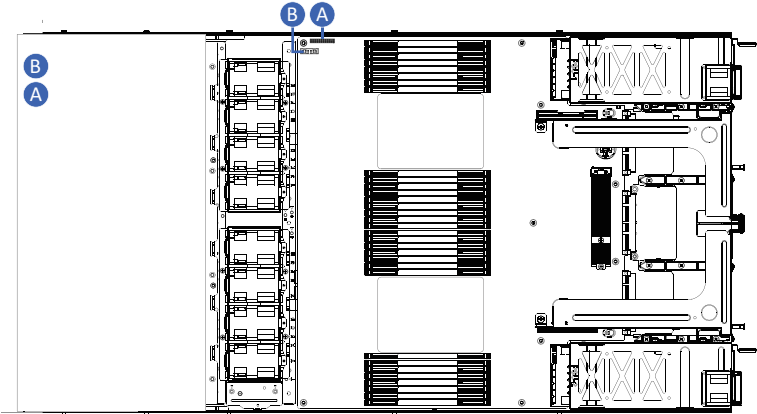

A	Front Switch/LED Cable	Motherboard: FP_1
		Front IO Board: FP_1
B	Front USB 3 Cable	Motherboard: F_USB1
		Front IO Board: F_USB3

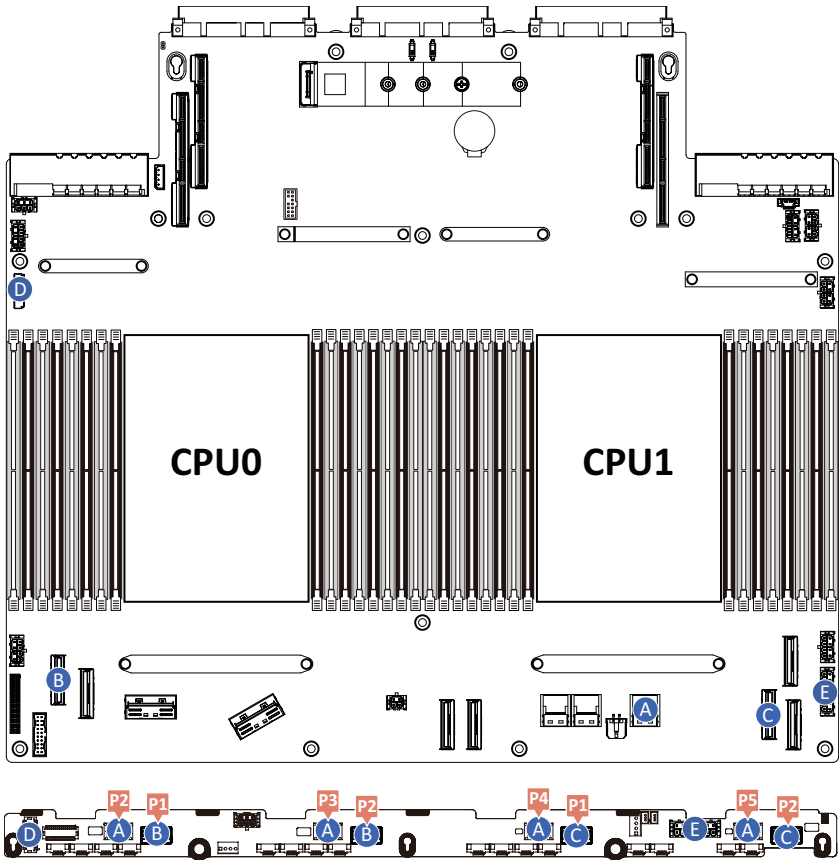

A	SATA Cable	Motherboard: SL_SATA1
		Backplane Board: SATA0/ SATA1/ SATA2/ SATA3
B	NVMe 0-1 Cable	Motherboard: MCIOP0_0AB1
		Backplane Board: U.2 0/ U.2 1
C	NVMe 2-3 Cable	Motherboard: MCIOP1_4AB1
		Backplane Board: U.2 2/ U.2 3
D	Backplane Board Signal Cable	Motherboard: BP_1
		Backplane Board: BP_1
E	Backplane Board Power Cable	Motherboard: ATX1
		Backplane Board: BP_2X7

Chapter 4 Motherboard Components

4-1 Motherboard Components

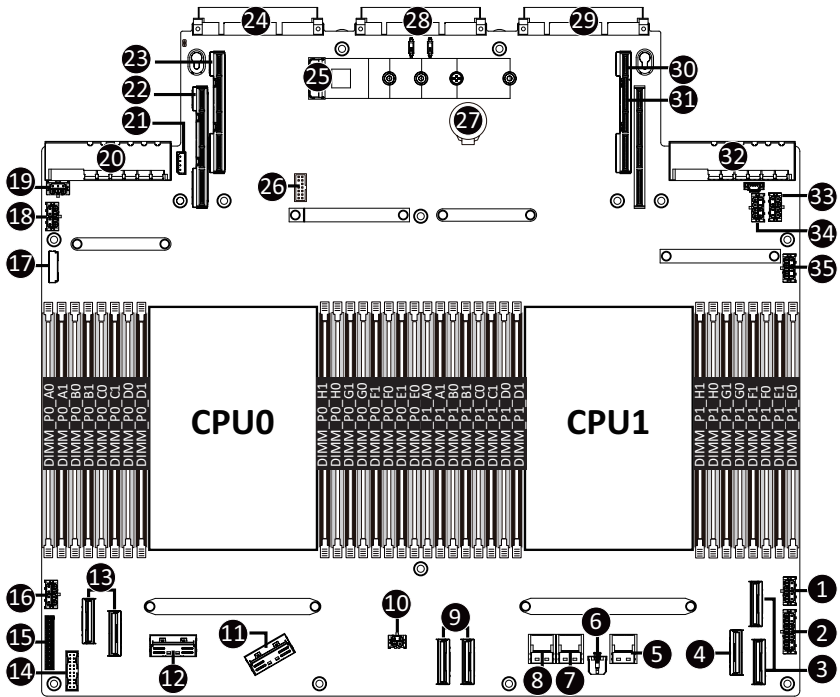

Item	Description
1	P12V Power Connector (P12V_INTE2)
2	2 x 7 Pin ATX Power Connector (ATX1)
3	MCI/O Connector (MCIOP1_3AB1/3CD1/PCIe Gen5)
4	MCI/O Connector (MCIOP1_4AB1/PCIe Gen5)
5	SlimSAS Connector (SL_SATA1)
6	2 x 2 P12V Backplane Power Connector (12V_BP2)
7	SlimSAS Connector (SL_SATA2)
8	SlimSAS Connector (SL_SATA3)
9	MCI/O Connector (MCIOP1_2AB1/2CD1/PCIe Gen5)
10	2 x 2 P12V Backplane Power Connector (12V_BP1)
11	MCI/O Connector (MCIOP0_1CD1/PCIe Gen5)
12	MCI/O Connector (MCIOP0_0CD1/PCIe Gen5)
13	MCI/O Connector (MCIOP0_0AB1/1AB1/PCIe Gen5)
14	Front Panel USB 3.2 Gen1 Connector
15	Front Panel Connector
16	P12V Power Connector (P12V_INTE1)
17	HDD Backplane Board Connector

Item	Description
18	2 x 4 Pin P12V GPU Power Connector (P12V_GPU2)
19	2 x 3 Pin ATX Power Connector (ATX3)
20	Power Supply Connector#1 (Primary)
21	IPMB Connector
22	Riser Connector (SLOT1/PCIe Gen5)
23	Riser Connector (SLOT2/PCIe Gen5)
24	OCP 3.0 Connector (OCP1/PCIe Gen5 x16)
25	M.2 Slot (PCIe Gen5 x4, NGFF-22110/Supports heatsink)
26	TPM Module Connector (SPI Interface)
27	System Battery Socket
28	IO Card Connector
29	OCP 3.0 Connector (OCP2/PCIe Gen5 x16)
30	Riser Connector (SLOT3/PCIe Gen5)
31	Riser Connector (SLOT4/PCIe Gen5)
32	Power Supply Connector#2 (Secondary)
33	2 x 3 Pin ATX Power Connector (ATX2)
34	2 x 4 Pin P12V GPU Power Connector (P12V_GPU3)
35	2 x 4 Pin P12V GPU Power Connector (P12V_GPU1)

4-2 Jumper Setting

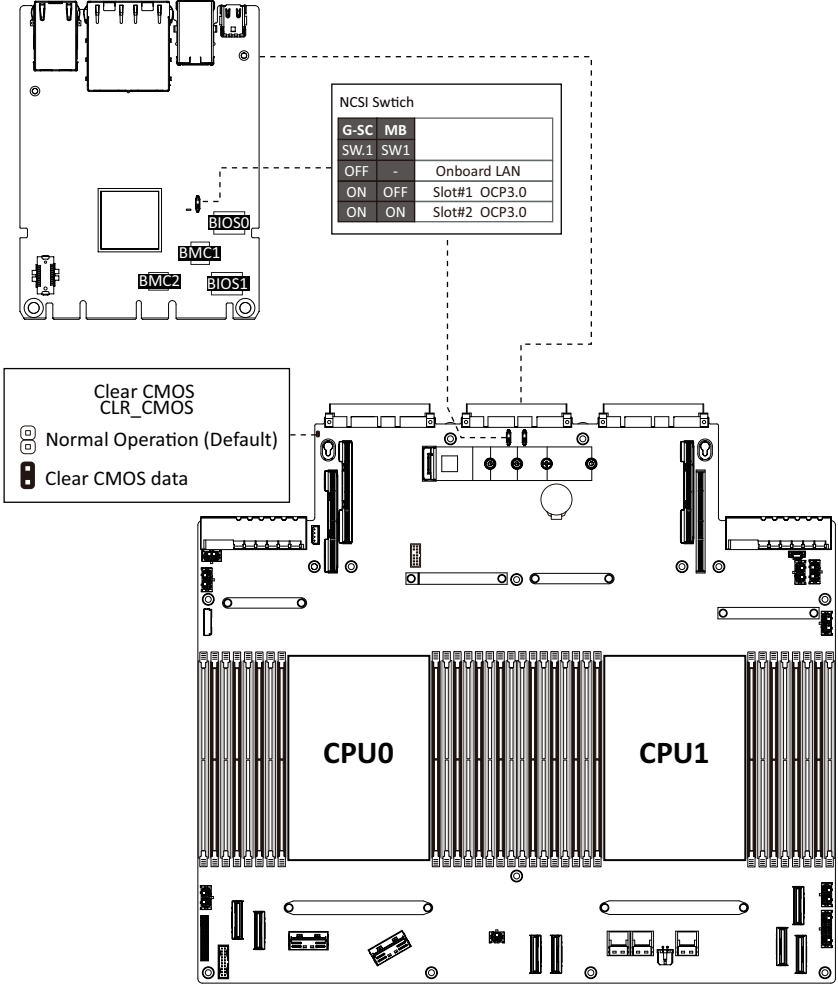

4-3 G-SC Module

4-3-1 CDCR115

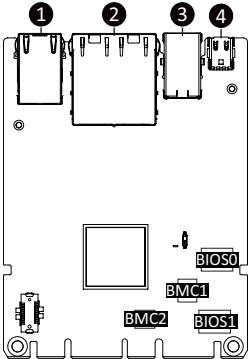

Item	Description
1	10/100/1000 Server Management LAN Port
2	Data LAN Port x 2
3	USB 3.2 Gen1 Port x 2
4	Mini DisplayPort

4-4 Backplane Board Storage Connector

4-4-1 CBP1048

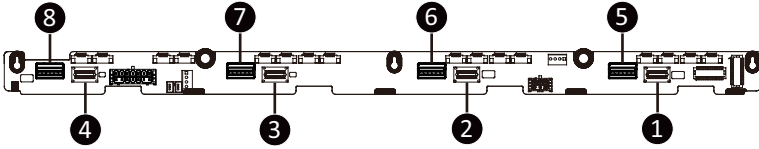

Item	Description
1	SlimSAS 4i Connector (SFF-8654 / SATA0)
2	SlimSAS 4i Connector (SFF-8654 / SATA1)
3	SlimSAS 4i Connector (SFF-8654 / SATA2)
4	SlimSAS 4i Connector (SFF-8654 / SATA3)
5	MCIO 4i (SFF-TA-1016 / U.2 0)
6	MCIO 4i (SFF-TA-1016 / U.2 1)
7	MCIO 4i (SFF-TA-1016 / U.2 2)
8	MCIO 4i (SFF-TA-1016 / U.2 3)

Chapter 5 BIOS Setup

BIOS (Basic Input and Output System) records hardware parameters of the system in the EFI on the motherboard. Its major functions include conducting the Power-On Self-Test (POST) during system startup, saving system parameters, loading the operating system etc. The BIOS includes a BIOS Setup program that allows the user to modify basic system configuration settings or to activate certain system features. When the power is turned off, the battery on the motherboard supplies the necessary power to the CMOS to keep the configuration values in the CMOS.

To access the BIOS Setup program, press the key during the POST when the power is turned on.



- BIOS flashing is potentially risky, if you do not encounter any problems when using the current BIOS version, it is recommended that you don't flash the BIOS. To flash the BIOS, do it with caution. Inadequate BIOS flashing may result in system malfunction.
- It is recommended that you not alter the default settings (unless you need to) to prevent system instability or other unexpected results. Inadequately altering the settings may result in system's failure to boot. If this occurs, try to clear the CMOS values and reset the board to default values. (Refer to the **Exit** section in this chapter or introductions of the battery/clearing CMOS jumper in Chapter 4 for how to clear the CMOS values.)

BIOS Setup Program Function Keys

<<-><->>	Move the selection bar to select the screen
<↑><↓>	Move the selection bar to select an item
<+>	Increase the numeric value or make changes
<->	Decrease the numeric value or make changes
<Enter>	Execute command or enter the submenu
<Esc>	Main Menu: Exit the BIOS Setup program Submenus: Exit current submenu
<F1>	Show descriptions of general help
<F3>	Restore the previous BIOS settings for the current submenus
<F9>	Load the Optimized BIOS default settings for the current submenus
<F10>	Save all the changes and exit the BIOS Setup program

■ **Main**

This setup page includes all the items of the standard compatible BIOS.

■ **Advanced**

This setup page includes all the items of AMI BIOS special enhanced features.

(ex: Auto detect fan and temperature status, automatically configure hard disk parameters.)

■ **Chipset**

This setup page includes all the submenu options for configuring the function of the chipset.

■ **Server Management**

Server additional features enabled/disabled setup menus.

■ **Security**

Change, set, or disable supervisor and user password. Configuration supervisor password allows you to restrict access to the system and BIOS Setup.

A supervisor password allows you to make changes in BIOS Setup.

A user password only allows you to view the BIOS settings but not to make changes.

■ **Boot**

This setup page provides items for configuration of the boot sequence.

■ **Save & Exit**

Save all the changes made in the BIOS Setup program to the CMOS and exit BIOS Setup. (Pressing <F10> can also carry out this task.)

Abandon all changes and the previous settings remain in effect. Pressing <Y> to the confirmation message will exit BIOS Setup. (Pressing <Esc> can also carry out this task.)

5-1 The Main Menu

Once you enter the BIOS Setup program, the Main Menu (as shown below) appears on the screen. Use arrow keys to move among the items and press <Enter> to accept or enter other sub-menu.

Main Menu Help

The on-screen description of a highlighted setup option is displayed on the bottom line of the Main Menu.

Submenu Help

While in a submenu, press <F1> to display a help screen (General Help) of function keys available for the menu. Press <Esc> to exit the help screen. Help for each item is in the Item Help block on the right side of the submenu.



- When the system is not stable as usual, select the **Restore Defaults** item to set your system to its defaults.
- The BIOS Setup menus described in this chapter are for reference only and may differ by BIOS version.

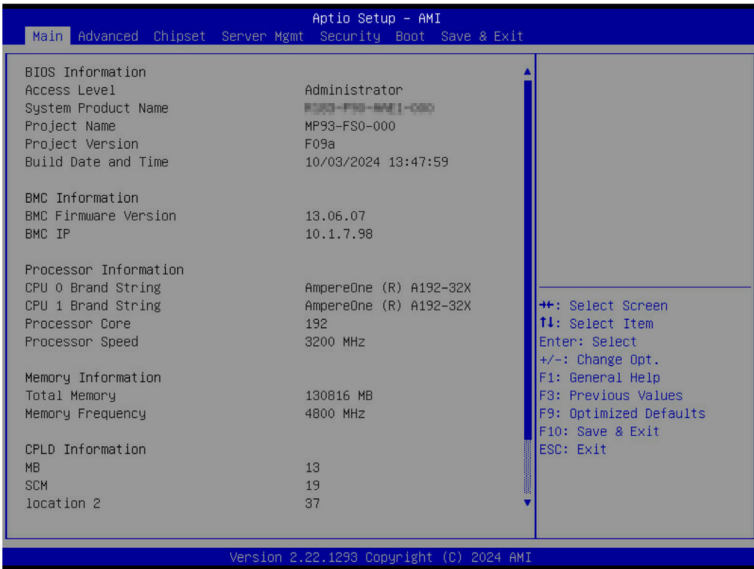

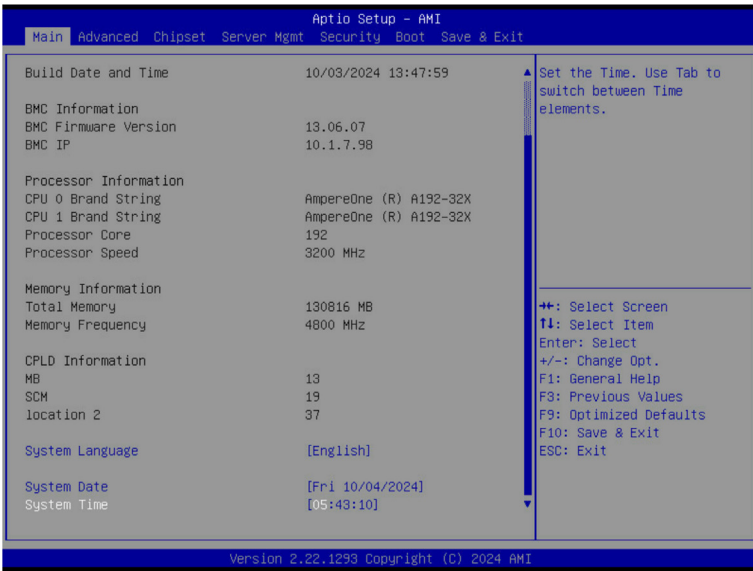

Parameter	Description
BIOS Information	
Access Level	Displays the privileges level information.
System Project Name	Displays the system project name information.
Project Name	Displays the motherboard project name information
Project Version	Displays version number of the BIOS setup utility.
Build Date and Time	Displays the date and time when the BIOS setup utility was created.
BMC Information ^(Note1)	
BMC Firmware Version ^(Note1)	Displays BMC firmware version information.
BMC IP	Displays BMC IP Address.
Processor Information	
CPU Brand String / Processor Core/ Processor Speed	Displays the technical specifications for the installed processor.
Memory Information	
Total Memory ^(Note2)	Displays the total memory size of the installed memory.
Memory Frequency ^(Note2)	Displays the frequency information of the installed memory.

(Note1) Functions available on selected models.

(Note2) This section will display capacity and frequency information of the memory that the customer has installed.

Parameter	Description
CPLD Information	
MB/SCM/location 2	Display CPLD information.
System Language	Option: English.
System Date	Sets the date following the weekday-month-day-year format.
System Time	Sets the system time following the hour-minute-second format.

5-2 Advanced Menu

The Advanced Menu displays submenu options for configuring the function of various hardware components. Select a submenu item, then press <Enter> to access the related submenu screen.

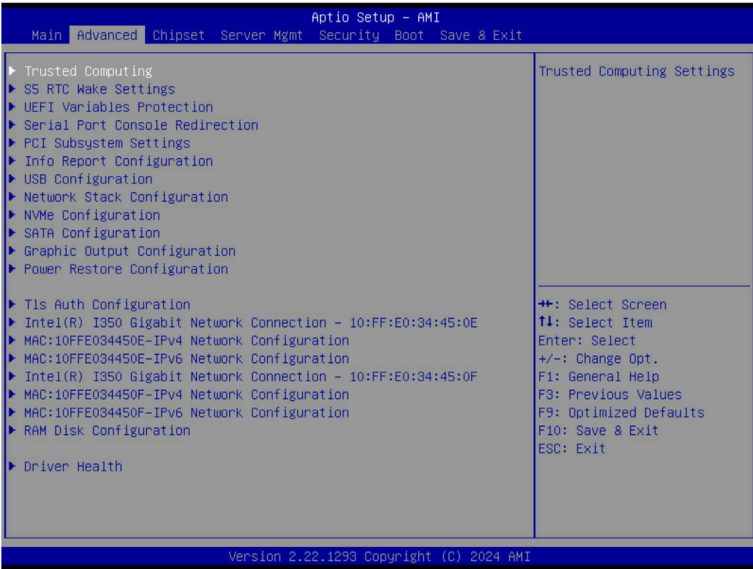

5-2-1 Trusted Computing

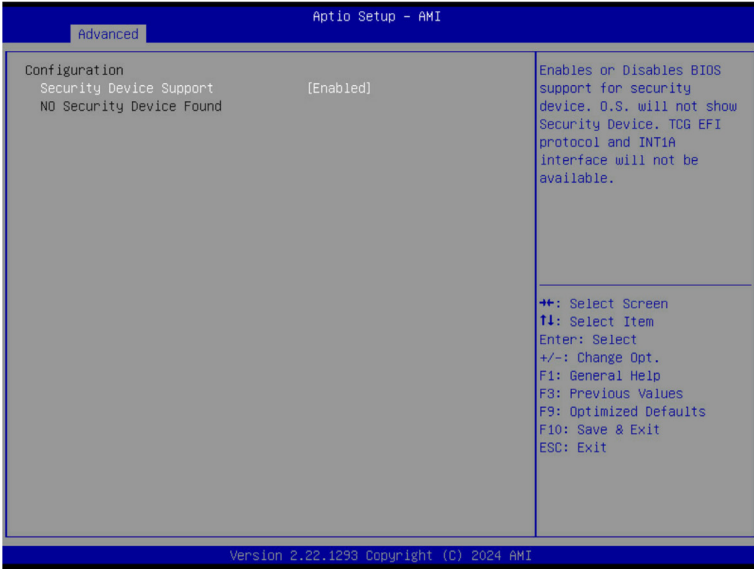

Parameter	Description
Configuration	
Security Device Support	<p>Enable/Disable BIOS support for security device. OS will not show security device. TCG EFI protocol and INT1A interface will not be available.</p> <p>Options available: Enabled, Disabled. Default setting is Enabled.</p>

5-2-2 S5 RTC Wake Settings



Parameter	Description
Wake System from S5	Enable/Disable system wake on alarm event. Options available: Disabled, Fixed Time, Dynamic Time. When Fixed Time is selected, system will wake on the hr::min::sec specified. Default setting is Disabled .

5-2-3 UEFI Variables Protection

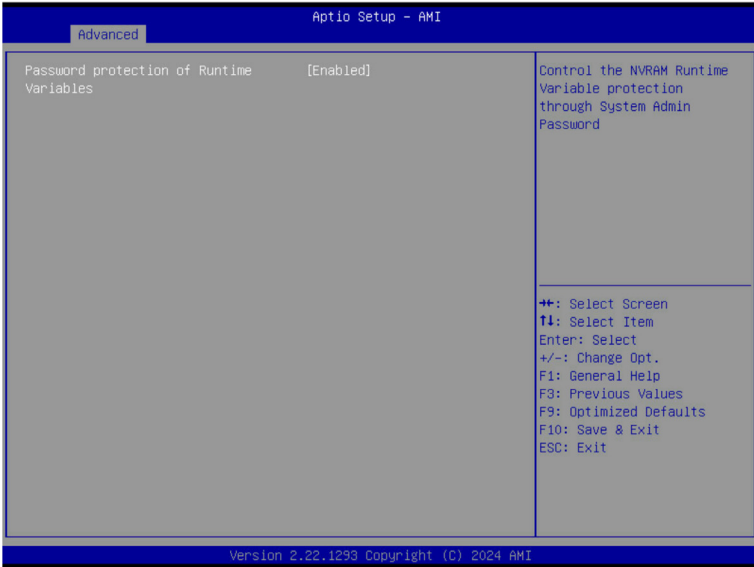

Parameter	Description
Password protection of Runtime Variables	Control the NVRAM Runtime Variable protection through system admin password. Options available: Enabled, Disabled. Default setting is Enabled .

5-2-4 Serial Port Console Redirection

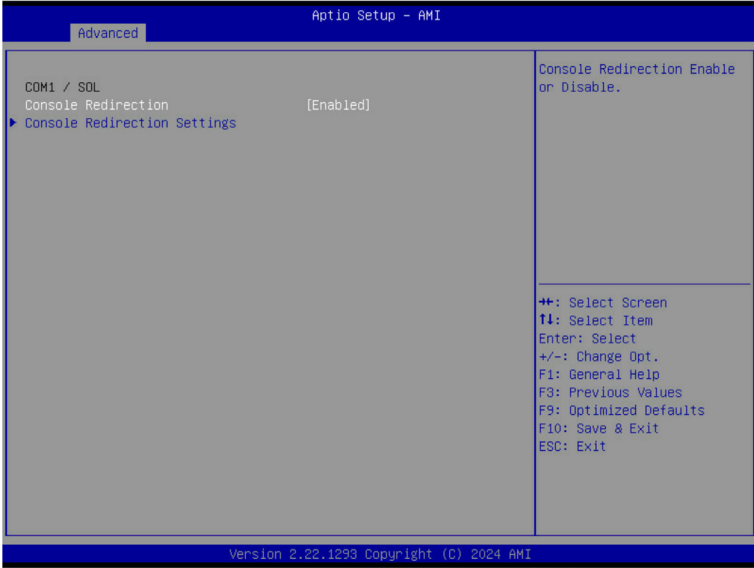

Parameter	Description
COM1/Serial Over LAN Console Redirection ^(Note)	<p>Select whether to enable console redirection for specified device. Console redirection enables the users to manage the system from a remote location.</p> <p>Options available: Enabled, Disabled. Default setting is Enabled.</p>
COM1/Serial Over LAN Console Redirection Settings	<p>Press [Enter] to configure advanced items.</p> <p>Please note that this item is configurable when COM1/Serial Over LAN Console Redirection is set to Enabled.</p> <ul style="list-style-type: none"> ◆ Terminal Type <ul style="list-style-type: none"> – Selects a terminal type to be used for console redirection. – Options available: VT100, VT100Plus, ANSI, VT-UTF8. Default setting is VT100Plus. ◆ Bits per second <ul style="list-style-type: none"> – Selects the transfer rate for console redirection. – Options available: 9600, 19200, 38400, 57600, 115200, 230400, 460800, 921600. Default setting is 115200. ◆ Data Bits <ul style="list-style-type: none"> – Selects the number of data bits used for console redirection. – Options available: 7, 8. Default setting is 8.

(Note) Advanced items prompt when this item is defined.

Parameter	Description
COM1/Serial Over LAN Console Redirection Settings (continued)	<ul style="list-style-type: none"> ◆ Parity <ul style="list-style-type: none"> – A parity bit can be sent with the data bits to detect some transmission errors. – Even: parity bit is 0 if the num of 1's in the data bits is even. – Odd: parity bit is 0 if num of 1's in the data bits is odd. – Mark: parity bit is always 1. Space: Parity bit is always 0. – Mark and Space Parity do not allow for error detection. – Options available: None, Even, Odd, Mark, Space. Default setting is None. ◆ Stop Bits <ul style="list-style-type: none"> – Stop bits indicate the end of a serial data packet. (A start bit indicates the beginning). The standard setting is 1 stop bit. Communication with slow devices may require more than 1 stop bit. – Options available: 1, 2. Default setting is 1. ◆ Flow Control <ul style="list-style-type: none"> – Flow control can prevent data loss from buffer overflow. When sending data, if the receiving buffers are full, a 'stop' signal can be sent to stop the data flow. Once the buffers are empty, a 'start' signal can be sent to re-start the flow. Hardware flow control uses two wires to send start/stop signals. – Options available: None, Hardware RTS/CTS. Default setting is None. ◆ VT-UTF8 Combo Key Support <ul style="list-style-type: none"> – Enable/Disable the VT-UTF8 Combo Key Support. – Options available: Enabled, Disabled. Default setting is Enabled. ◆ Recorder Mode <ul style="list-style-type: none"> – When this mode enabled, only texts will be send. This is to capture Terminal data. – Options available: Enabled, Disabled. Default setting is Disabled. ◆ Resolution 100x31 <ul style="list-style-type: none"> – Enable/Disable extended terminal resolution. – Options available: Enabled, Disabled. Default setting is Enabled. ◆ Putty KeyPad <ul style="list-style-type: none"> – Selects Function Key and KeyPad on Putty. – Options available: VT100, LINUX, XTERMR6, SC0, ESCN, VT400. Default setting is VT100.

5-2-5 PCI Subsystem Settings

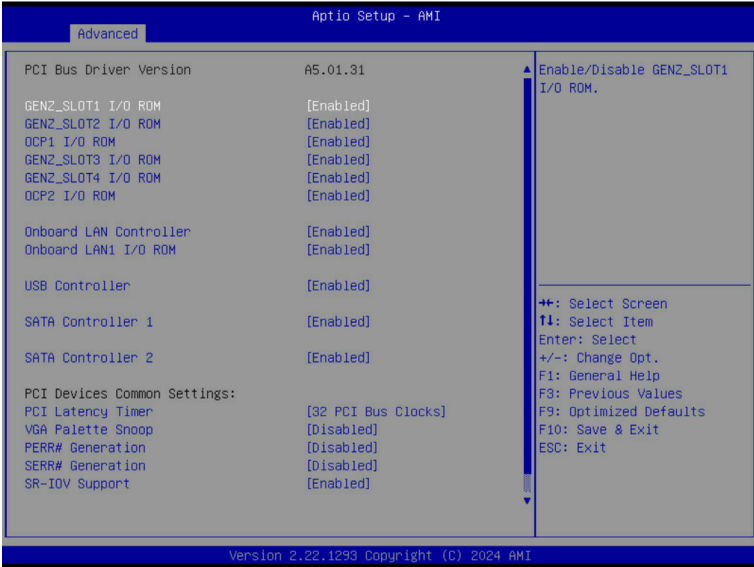

Parameter	Description
PCI Bus Driver Version	Displays the PCI Bus Driver version information.
GENZ_SLOT1/2/3/4 OCP1/2 I/O ROM	When enabled, this setting will initialize the device expansion ROM for the related devices. Options available: Disabled, Enabled. Default setting is Enabled .
Onboard LAN Controller	Enable/Disable the onboard LAN devices. Options available: Disabled, Enabled. Default setting is Enabled .
Onboard LAN# I/O ROM	Enable/Disable the onboard LAN devices, and initializes device expansion ROM. Options available: Disabled, Enabled. Default setting is Enabled .
USB Controller	Options available: Disabled, Enabled. Default setting is Enabled .
SATA Controller 1/2	Options available: Disabled, Enabled. Default setting is Enabled .
PCI Devices Common Settings	
PCI Latency Timer	Value to be programmed into PCI Latency Timer Register. Options available: 32 PCI Bus Clocks, 64 PCI Bus Clocks, 96 PCI Bus Clocks, 128 PCI Bus Clocks, 160 PCI Bus Clocks, 192 PCI Bus Clocks, 224 PCI Bus Clocks, 248 PCI Bus Clocks. Default setting is Enabled .

Parameter	Description
VGA Palette Snoop	Options available: Disabled, Enabled. Default setting is Disabled .
PERR# Generation	Options available: Disabled, Enabled. Default setting is Disabled .
SERR# Generation	Options available: Disabled, Enabled. Default setting is Disabled .
SR-IOV Support	If the system has SR-IOV capable PCIe devices, this item Enable/Disable Single Root IO Virtualization Support. Options available: Disabled, Enabled. Default setting is Enabled .

5-2-6 Info Report Configuration

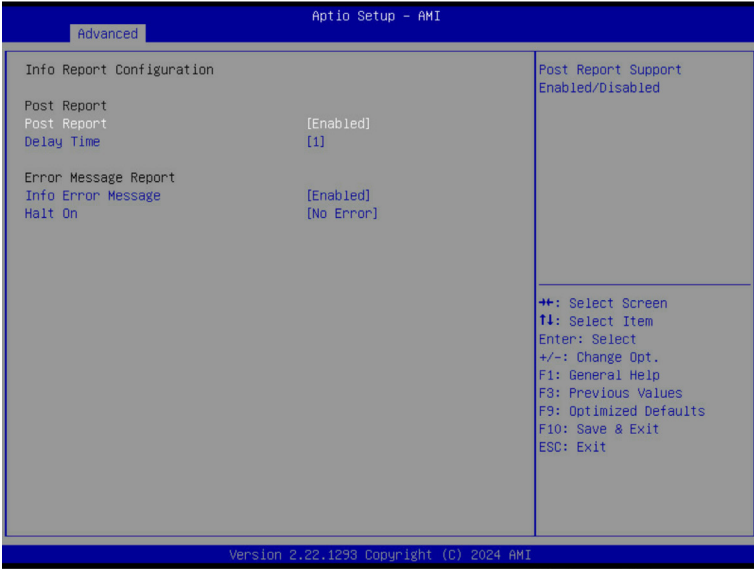

Parameter	Description
Post Report	
Post Report	Enable/disable post report support. Options available: Enabled, Disabled. Default setting is Enabled .
Delay Time	Options available: 0,1,2,3,4,5,6,7,8,9,10, Until Press ESC. Default setting is 1.
Error Message Report	
Info Error Message	Enable/disable Info error message support. Options available: Enabled, Disabled. Default setting is Enabled .
Halt on	Options available: No Error All Error All, but Keyboard. Default setting is No Error .

5-2-7 USB Configuration

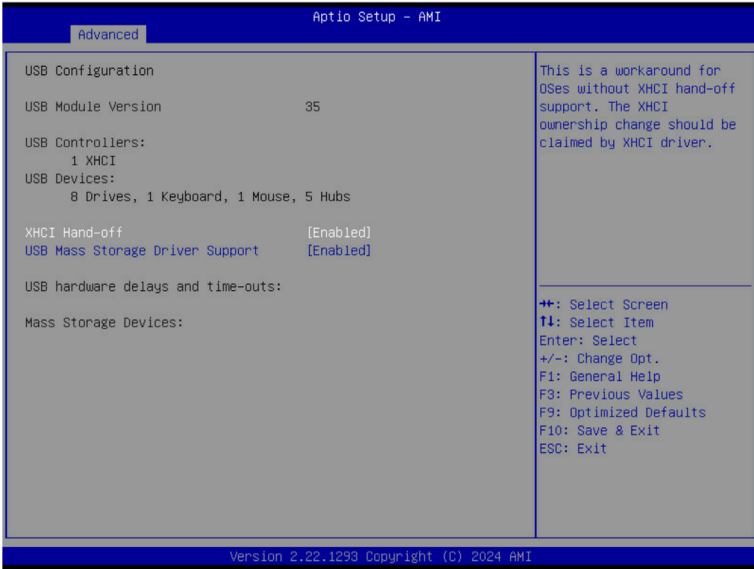

Parameter	Description
USB Configuration	
USB Module Version	Displays the USB module version information.
USB Controllers	Displays the supported USB controllers.
USB Devices:	Displays the USB devices connected to the system.
XHCI Hand-off	Enable/Disable the XHCI (USB 3.0) Hand-off support. Options available: Enabled, Disabled. Default setting is Enabled .
USB Mass Storage Driver Support ^(Note)	Enable/Disable the USB Mass Storage Driver Support. Options available: Enabled, Disabled. Default setting is Enabled .

(Note) This item is present only if you attach USB devices.

5-2-8 Network Stack Configuration

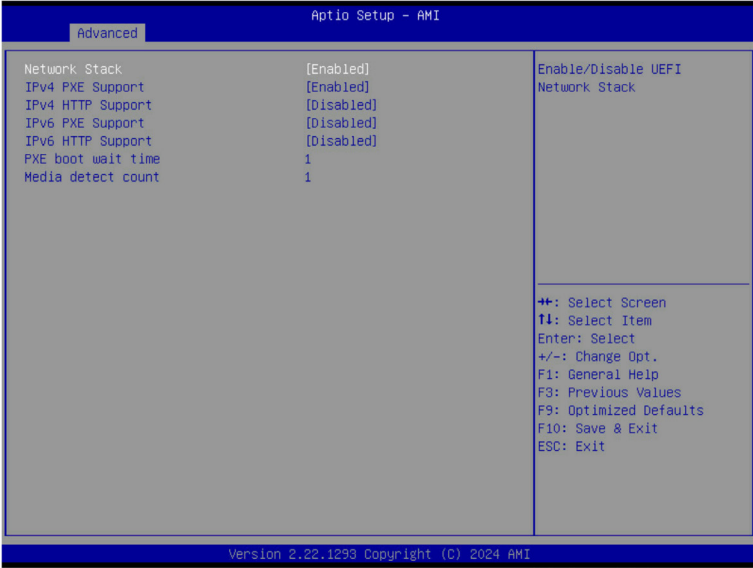

Parameter	Description
Network Stack	Enable/Disable the UEFI network stack. Options available: Enabled, Disabled. Default setting is Enabled .
Ipv4 PXE Support ^(Note)	Enable/Disable the Ipv4 PXE feature. Options available: Enabled, Disabled. Default setting is Enabled .
Ipv4 HTTP Support ^(Note)	Enable/Disable the Ipv4 HTTP feature. Options available: Enabled, Disabled. Default setting is Disabled .
Ipv6 PXE Support ^(Note)	Enable/Disable the Ipv6 PXE feature. Options available: Enabled, Disabled. Default setting is Enabled .
Ipv6 HTTP Support ^(Note)	Enable/Disable the Ipv6 HTTP feature. Options available: Enabled, Disabled. Default setting is Disabled .
PXE boot wait time ^(Note)	Wait time in seconds to press ESC key to abort the PXE boot. Press the <+> / <-> keys to increase or decrease the desired values.
Media detect count ^(Note)	Number of times the presence of media will be checked. Press the <+> / <-> keys to increase or decrease the desired values.

(Note) This item appears when **Network Stack** is set to **Enabled**.

5-2-9 NVMe Configuration

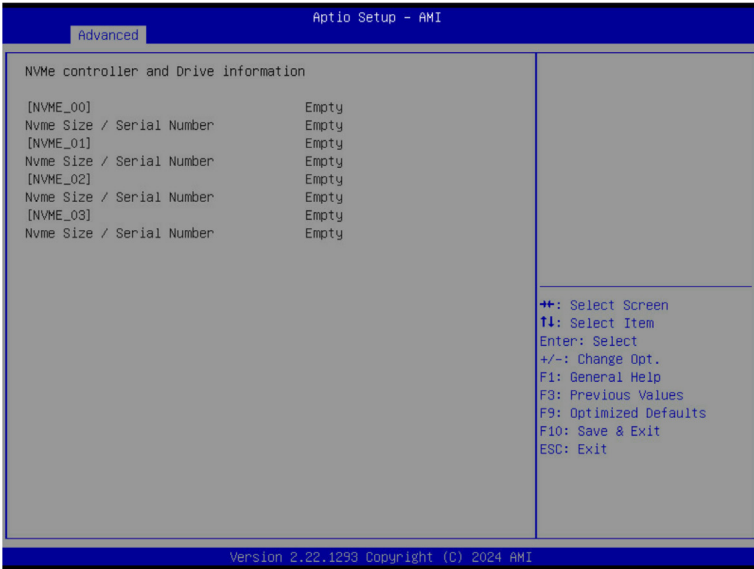

Parameter	Description
NVMe controller and Drive information	Displays the NVMe devices connected to the system

5-2-10 SATA Configuration

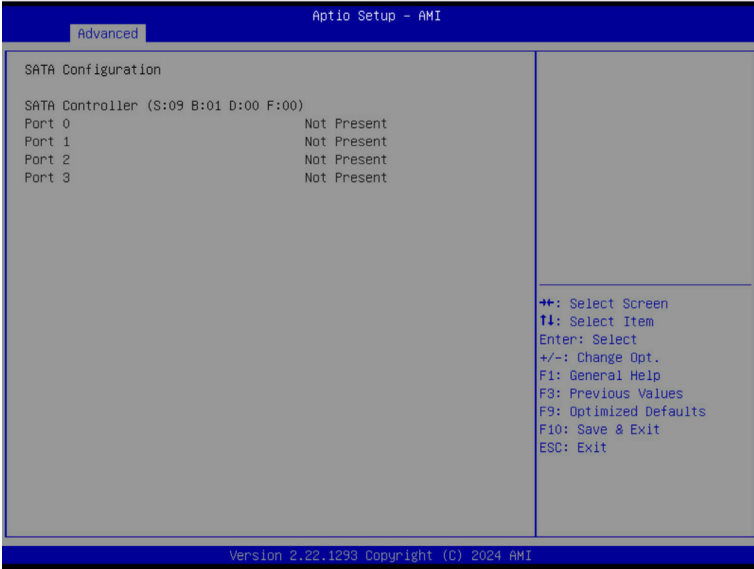

Parameter	Description
SATA Configuration	Displays the installed HDD devices information. System will automatically detect HDD type.

5-2-11 Graphic Output Configuration

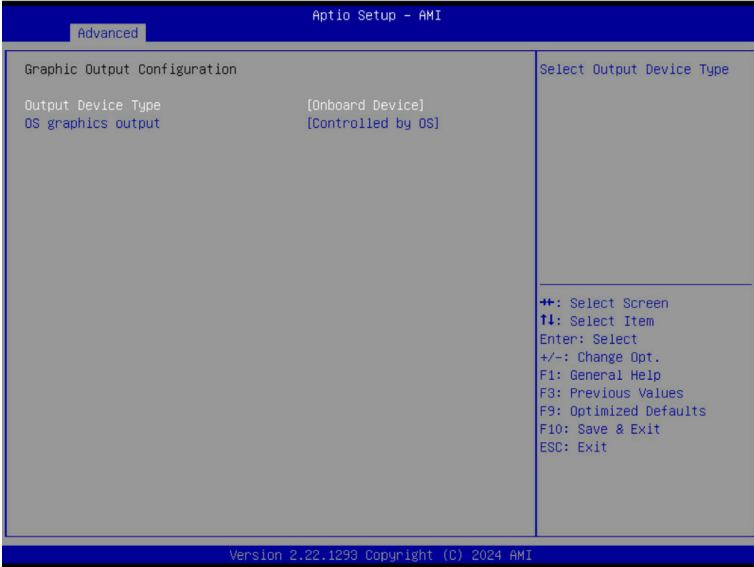

Parameter	Description
Graphic Output Configuration	
Output Device Type	Selects output device type. Options available: First loaded Device, Onboard Device, External Device, Specific Device. Default setting is Onboard Device .
OS graphics output	Use Onboard graphics output under OS (BMC KVM requires onboard graphics output). Options available: Controlled by OS, Onboard VGA. Default setting is Controlled by OS .

5-2-12 Power Restore Configuration

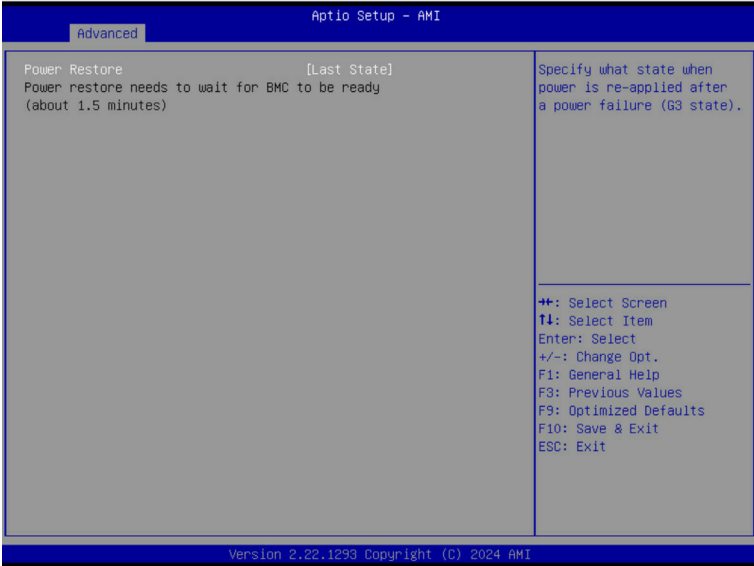

Parameter	Description
Power Restore	Specifies what state when power is re-applied after a power failure (G3 state). Options available: Power Off, Power On, Last State. Default setting is Last State .

5-2-13 Tls Auth Configuration

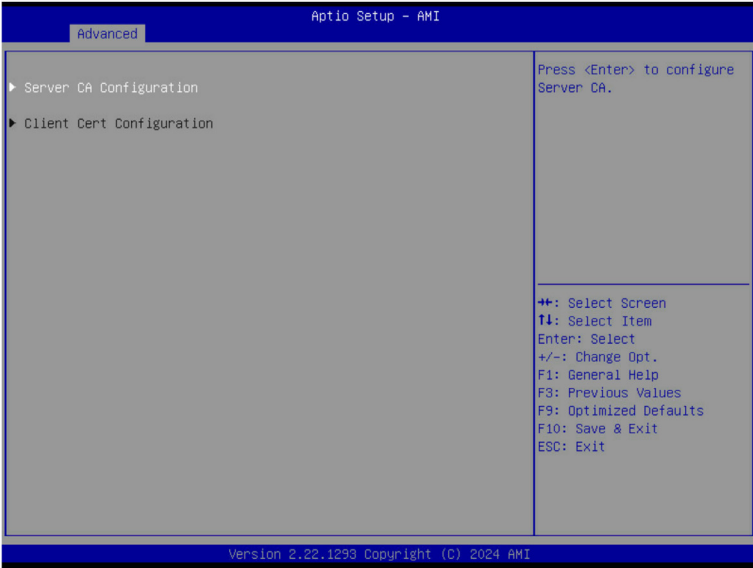

Parameter	Description
Server CA Configuration	<p>Press [Enter] for configuration of advanced items.</p> <ul style="list-style-type: none"> ◆ Enroll Cert <ul style="list-style-type: none"> – Press [Enter] to enroll a certificate <ul style="list-style-type: none"> • Enroll Cert Using File • Cert GUID <p>Input digit character in 1111111-2222-3333-4444-1234567890ab format.</p> <ul style="list-style-type: none"> – Commit Changes and Exit – Discard Changes and Exit <ul style="list-style-type: none"> ◆ Delete Cert
Client Cert Configuration	Press [Enter] for configuration of advanced items.

5-2-14 Intel(R) I350 Gigabit Network Connection

Advanced Aptio Setup - AMI		
<p>▶ NIC Configuration</p> <p>Blink LEDs 0</p> <p>UEFI Driver Intel(R) PRO/1000 Open Source 9.2.06 PCI-E</p> <p>Adapter PBA 106300-000</p> <p>Device Name Intel(R) I350 Gigabit Network Connection</p> <p>Chip Type Intel i350</p> <p>PCI Device ID 1521</p> <p>PCI Address 01:00:00</p> <p>Link Status [Disconnected]</p> <p>MAC Address 10:FF:E0:34:45:0E</p> <p>Virtual MAC Address 00:00:00:00:00:00</p>		<p>Click to configure the network device port.</p> <hr/> <p> ++: Select Screen ↑↓: Select Item Enter: Select +/-: Change Opt. F1: General Help F3: Previous Values F9: Optimized Defaults F10: Save & Exit ESC: Exit </p>
Version 2.22.1293 Copyright (C) 2024 AMI		

Advanced Aptio Setup - AMI		
<p>Link Speed [Auto Negotiated]</p> <p>Wake On LAN [Enabled]</p>		<p>Specifies the port speed used for the selected boot protocol.</p> <hr/> <p> ++: Select Screen ↑↓: Select Item Enter: Select +/-: Change Opt. F1: General Help F3: Previous Values F9: Optimized Defaults F10: Save & Exit ESC: Exit </p>
Version 2.22.1293 Copyright (C) 2024 AMI		

Parameter	Description
NIC Configuration	<p>Press [Enter] to configure advanced items.</p> <ul style="list-style-type: none"> ◆ Link Speed <ul style="list-style-type: none"> – Allows for automatic link speed adjustment. – Options available: Auto Negotiated, 10 Mbps Half, 10 Mbps Full, 100 Mbps Half, 100 Mbps Full. Default setting is Auto Negotiated. ◆ Wake On LAN <ul style="list-style-type: none"> – Enables power on of the system via LAN. Note that configuring Wake on LAN in the operating system does not change the value of this setting, but does override the behavior of Wake on LAN in OS controlled power states. – Options available: Enabled, Disabled. Default setting is Enabled.
Blink LEDs	<p>Identifies the physical network port by blinking the associated LED. Press the numeric keys to adjust desired values (up to 15 seconds).</p>
UEFI Driver	Displays the technical specifications for the Network Interface Controller.
Adapter PBA	Displays the technical specifications for the Network Interface Controller.
Device Name	Displays the technical specifications for the Network Interface Controller.
Chip Type	Displays the technical specifications for the Network Interface Controller.
PCI Device ID	Displays the technical specifications for the Network Interface Controller.
PCI Address	Displays the technical specifications for the Network Interface Controller.
Link Status	Displays the technical specifications for the Network Interface Controller.
MAC Address	Displays the technical specifications for the Network Interface Controller.
Virtual MAC Address	Displays the technical specifications for the Network Interface Controller.

5-2-15 MAC IPv4 Network Configuration

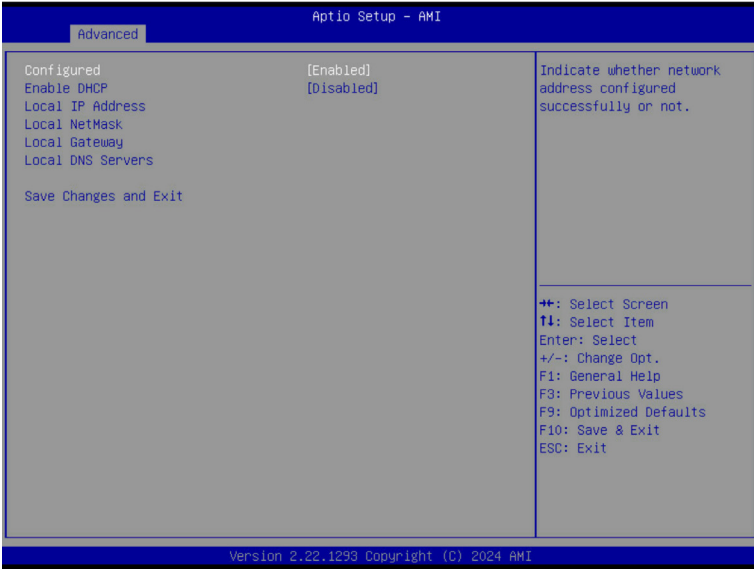

Parameter	Description
Configured	Indicates whether network address is configured successfully or not. Options available: Enabled, Disabled. Default setting is Disabled .
Enable DHCP ^(Note)	Options available: Enabled, Disabled. Default setting is Disabled .
Local IP Address ^(Note)	Press [Enter] to configure local IP address.
Local NetMask ^(Note)	Press [Enter] to configure local NetMask.
Local Gateway ^(Note)	Press [Enter] to configure local Gateway
Local DNS Servers ^(Note)	Press [Enter] to configure local DNS servers
Save Changes and Exit	Press [Enter] to save all configurations.

(Note) This item appears when **Configured** is set to **Enabled**.

5-2-16 MAC IPv6 Network Configuration

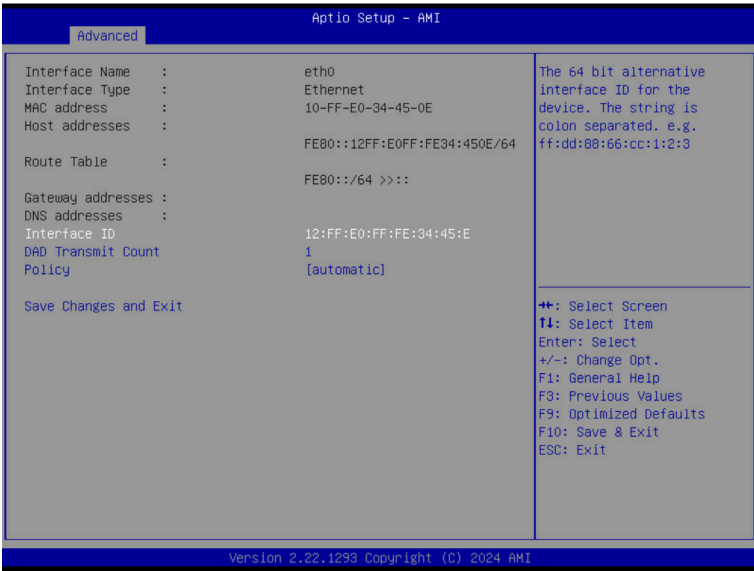

Parameter	Description
Enter Configuration Menu	<p>Press [Enter] to configure advanced items.</p> <ul style="list-style-type: none"> ◆ Displays the MAC Address information. ◆ Interface ID <ul style="list-style-type: none"> – The 64 bit alternative interface ID for the device. The string is colon separated. e.g. ff:dd:88:66:cc:1:2:3. ◆ DAD Transmit Count <ul style="list-style-type: none"> – The number of consecutive Neighbor solicitation messages sent while performing Duplicate Address Detection on a tentative address. A value of zero indicates that Duplicate Address Detection is not performed. ◆ Policy <ul style="list-style-type: none"> – Options available: automatic, manual. Default setting is automatic. ◆ Save Changes and Exit <ul style="list-style-type: none"> – Press [Enter] to save all configurations.

5-2-17 RAM Disk Configuration

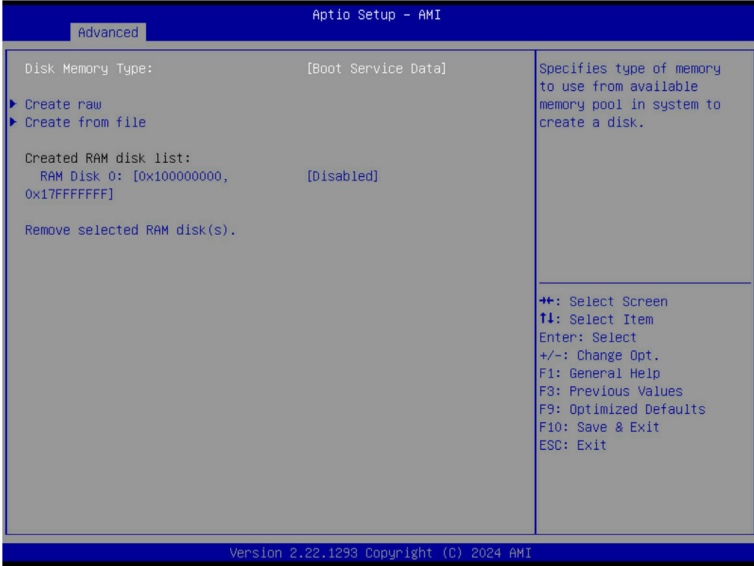

Parameter	Description
Disk Memory Type	Specifies the type of memory to use from available memory pool in system to create a disk. Options available: Boot Service Data, Reserved. Default setting is Boot Service Data .
Create Raw	Creates a raw RAM disk. <ul style="list-style-type: none"> ◆ Size (Hex) <ul style="list-style-type: none"> – Input a valid RAM disk size that should be multiple of the RAM disk block size. ◆ Create & Exit ◆ Discard & Exit
Create from file	Creates a RAM disk from a given file.
Created RAM disk list	
Remove selected RAM disk(s)	Selects the RAM disk(s) to remove.

5-2-18 Driver Health



Parameter	Description
Driver Health	Displays health status of the drivers/controllers if installed.

5-3 Chipset Setup Menu

Chipset Setup menu displays submenu options for configuring the function of the chipset. Select a submenu item, then press <Enter> to access the related submenu screen.



Parameter	Description
Memory Configuration	Press [Enter] for configuration of advanced items.
CPU Configuration	Press [Enter] for configuration of advanced items.
PCIE Device Configuration	Press [Enter] for configuration of advanced items.
PCIE Root Complex Configuration	Press [Enter] for configuration of advanced items.
Power Policy	Press [Enter] for configuration of advanced items.
Power Button 1s shutdown	Options available: Disabled, Enabled. Default setting is Enabled .

5-3-1 Memory Configuration

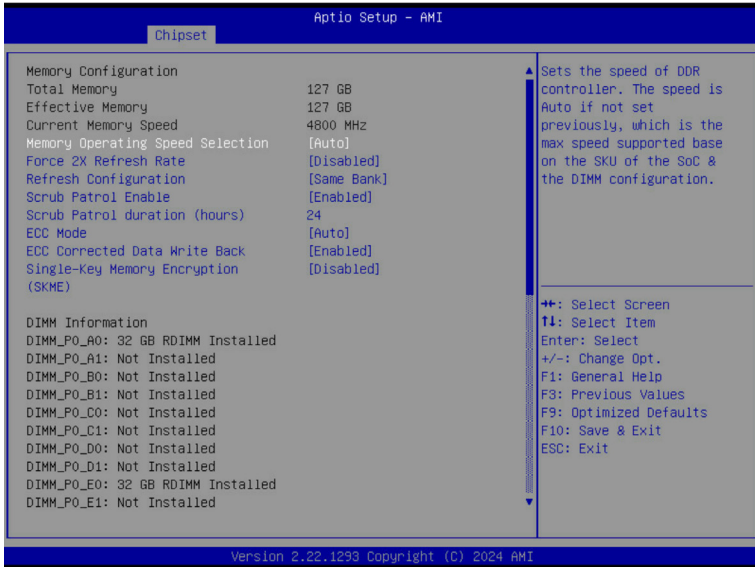

Parameter	Description
Memory Configuration	
Total Memory/ Effective Memory/ Current Memory Speed	Displays the technical specifications for the installed memory module.
Memory Operating Speed Selection	Options available: Auto, 3200, 3600, 4000, 4400, 4800, 5200, 5600. Default setting is Auto .
Force 2X Refresh Rate	Options available: Disabled, Enabled. Default setting is Disabled .
Refresh Configuration	Options available: Normal, Fine Granularity, Same Bank. Default setting is Same Bank .
Scrub Patrol Enable	Options available: Disabled, Enabled. Default setting is Enabled .
Scrub Patrol duration (hours)	Select duration (hours) for Scrub Patrol. Default setting is 24 .
ECC Mode	Options available: Disabled, SECDED 64+8, SECDED 128+4+9, Symbol 64+16, Symbol 64+14+2, Symbol 256+8+24, Auto. Default setting is Auto .
ECC Corrected Data Write Back	Options available: Disabled, Enabled. Default setting is Enabled .
Single-Key Memory Encryption (SKME)	Options available: Disabled, Enabled. Default setting is Disabled .
DIMM Information	Displays installed DIMM information.

5-3-2 CPU Configuration

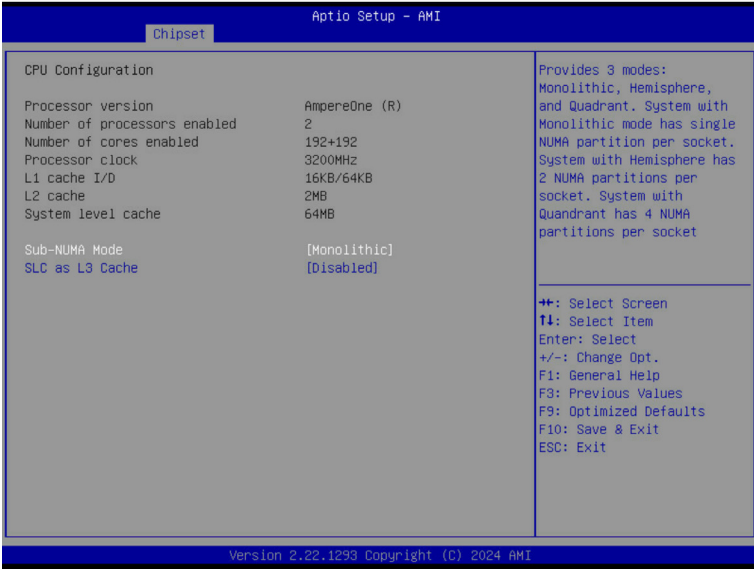

Parameter	Description
CPU Configuration	
Processor version/ Number of processors/cores enabled/ Processor clock/ L1 Cache ID/ L2 cache/ System level cache	Displays the technical specifications for the installed processor(s)..
Sub-NUMA Mode	Options available: Monolithic, Hemisphere, Quadrant. Default setting is Monolithic .
SLC as L3 Cache	Enable/Disable PPTT to indicate SLC as L3 Cache. This is limited to only 1P Monolithic mode. Options available: Enabled, Disabled. Default setting is Disabled .

5-3-3 ACPI Configuration

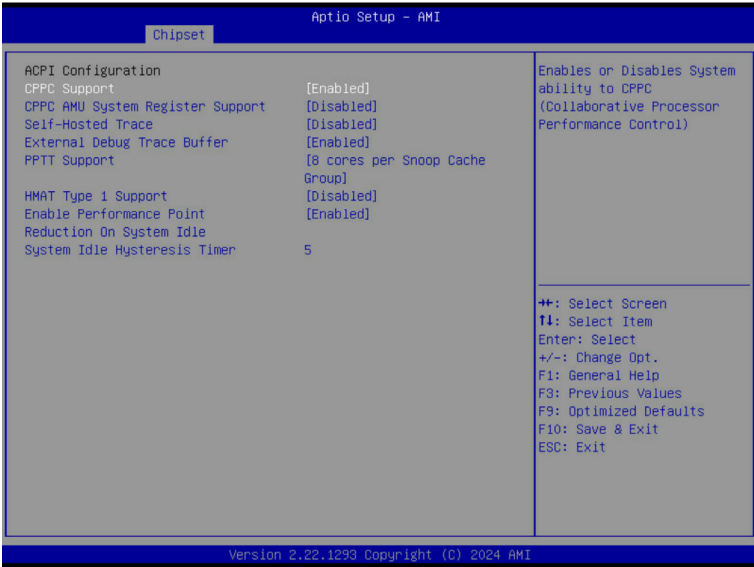

Parameter	Description
ACPI Configuration	
CPPC Support	Options available: Disabled, Enabled. Default setting is Enabled .
CPPC AMU System Register Support	Options available: Disabled, Enabled. Default setting is Disabled .
Self-Hosted Trace	Options available: Disabled, Enabled. Default setting is Disabled .
External Debug Trace Buffer	Options available: Disabled, Enabled. Default setting is Enabled .
PPTT Support	Options available: None, Flat, CCM-based, 8 cores per Snoop Cache Group, Anti Snoop Cache Group. Default setting is 8 cores per Snoop Cache Group .
HWAT Type 1 Support	Options available: Disabled, Enabled. Default setting is Disabled .
Enable Performance Point Reduction On System Idle	Options available: Disabled, Enabled. Default setting is Enabled .
System Idle Hysteresis Timer	Value of System Idle Hysteresis Timer in mS.

5-3-4 PCIe Device Configuration

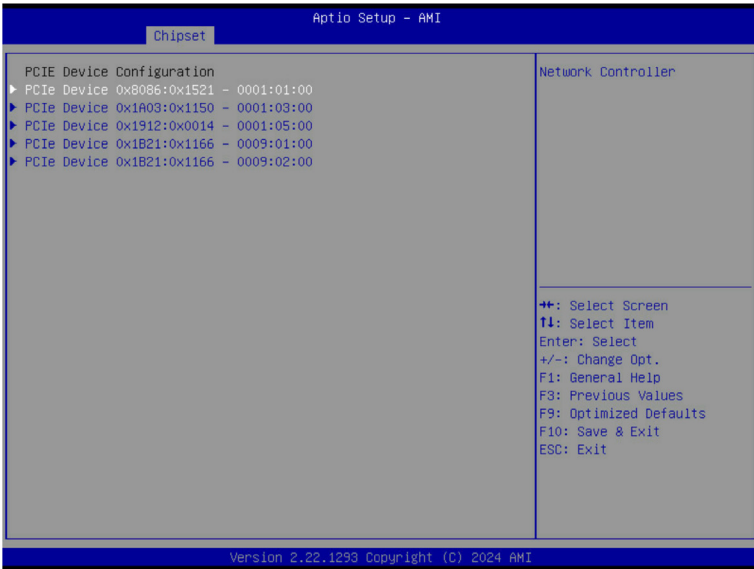

Parameter	Description
PCIe Device Configuration	Press [Enter] to configure advanced items.
PCIe Device#	<ul style="list-style-type: none"> ◆ Max_Payload_Size/Max_Read_Request_Size mode <ul style="list-style-type: none"> – Options available: Auto Manual. Default setting is Auto. ◆ Max Payload Size <ul style="list-style-type: none"> – Options available: 512 bytes, 256 bytes, 128 bytes. Default setting is 512 bytes. ◆ Max Read Request Size <ul style="list-style-type: none"> – Options available: 4096 bytes, 2048 bytes, 1024 bytes, 512 bytes, 256 bytes, 128 bytes. Default setting is 512 bytes. ◆ Enabled SERR# <ul style="list-style-type: none"> – Options available: Enabled, Disabled. Default setting is Enabled.

5-3-5 PCIe Root Complex Configuration

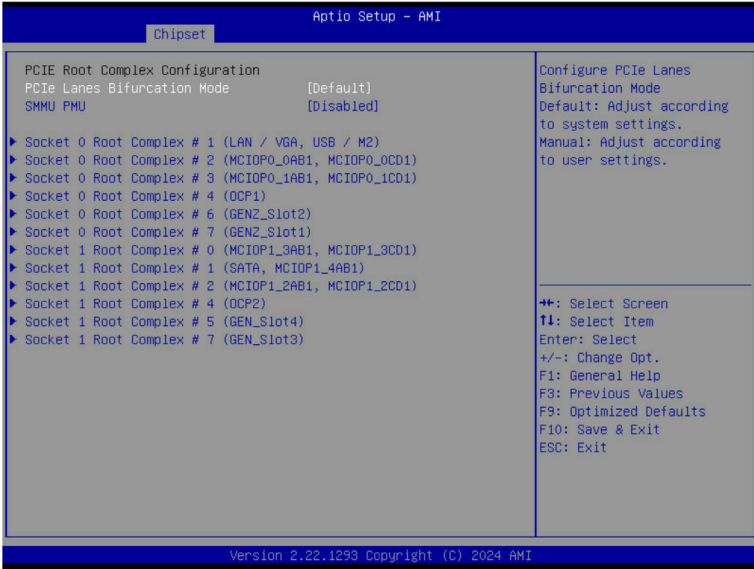

Parameter	Description
PCIe Root Complex Configuration	
PCIe Lanes Bifurcation Mode	Options available: Manual, Default. Default setting is Default .
SMMU PMU	Options available: Disabled, Enabled. Default setting is Disabled .
Root Complex # ^(Note)	Press [Enter] to view advanced items.

(Note) This item is configurable when **PCIe Lanes Bifurcation Mode** is set to **Manual**.

5-3-6 Power Policy



Parameter	Description
Power Policy Quick Settings	Options available: Standard, Best Performance, Energy Efficient. Default setting is Standard .

5-4 Server Management Menu

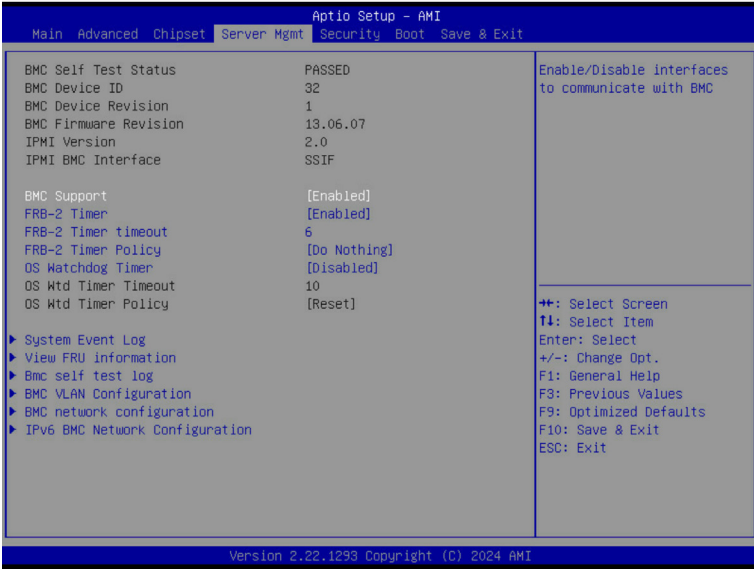

Parameter	Description
BMC Self Test Status/ BMC Device ID/ BMC Device Revision/ BMC Firmware Revision/ IPMI Version/ IPMI BMC Interface	Displays the technical specification of the BMC controller.
BMC Support	Options available: Enabled, Disabled. Default setting is Enabled .
FRB-2 Timer	Enable/Disable FRB-2 timer (POST timer). Options available: Enabled, Disabled. Default setting is Enabled .
FRB-2 Timer ^(Note) timeout	Configures the FRB2 Timer timeout. The value is between 1 to 30 minutes. Default setting is 6 minutes .
FRB-2 Timer Policy ^(Note)	Configures the FRB2 Timer policy. Options available: Do Nothing, Reset, Power Down, Power Cycle. Default setting is Do Nothing .
OS Watchdog Timer	Enable/Disable OS Watchdog Timer function. Options available: Enabled, Disabled. Default setting is Disabled .

(Note) This item is configurable when **FRB-2 Timer** is set to **Enabled**.

Parameter	Description
OS Wtd Timer Timeout ^(Note)	Configures OS Watchdog Timer. The value is between 1 to 30 minutes. Default setting is 10 minutes .
OS Wtd Timer Policy ^(Note)	Configure OS Watchdog Timer Policy. Options available: Reset, Do Nothing, Power Down, Power Cycle. Default setting is Reset .
System Event Log	Press [Enter] to configure advanced items.
View FRU Information	Press [Enter] to view the FRU information.
Bmc self test log	Press [Enter] to configure advanced items.
BMC VLAN Configuration	Press [Enter] to configure advanced items.
BMC network configuration	Press [Enter] to configure advanced items.
IPv6 BMC Network Configuration	Press [Enter] to configure advanced items.

(Note) This item is configurable when **OS Watchdog Timer** is set to **Enabled**.

5-4-1 System Event Log

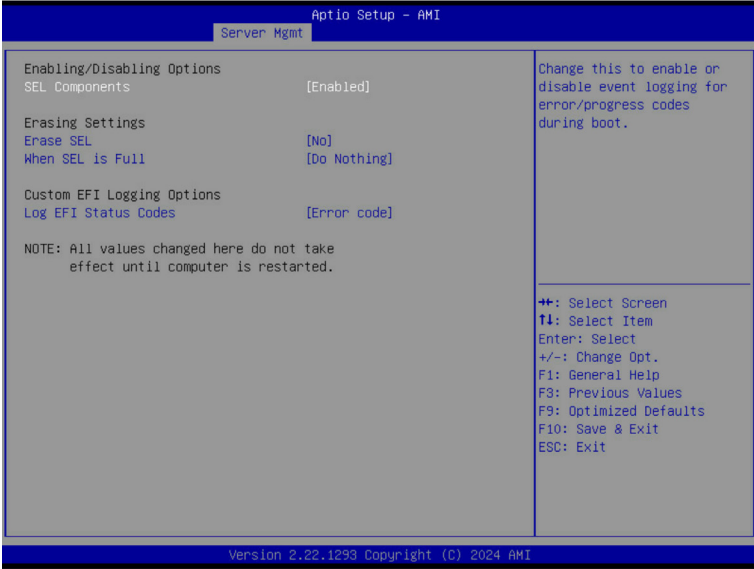

Parameter	Description
Enabling / Disabling Options	
SEL Components	Change this item to enable or disable all features of System Event Logging during boot. Options available: Enabled, Disabled. Default setting is Enabled .
Erasing Settings	
Erase SEL	Choose options for erasing SEL. Options available: No/Yes, On next reset/Yes, On every reset. Default setting is No .
When SEL is Full	Choose options for reactions to a full SEL. Options available: Do Nothing, Erase Immediately, Delete Oldest Record. Default setting is Do Nothing .
Custom EFI Logging Options	
Log EFI Status Codes	Enable/Disable the logging of EFI Status Codes (if not already converted to legacy). Options available: Disabled, Both, Error code, Progress code. Default setting is Error code .

5-4-2 View FRU Information

The FRU page is a simple display page for basic system ID information, as well as System product information. Items on this window are non-configurable.

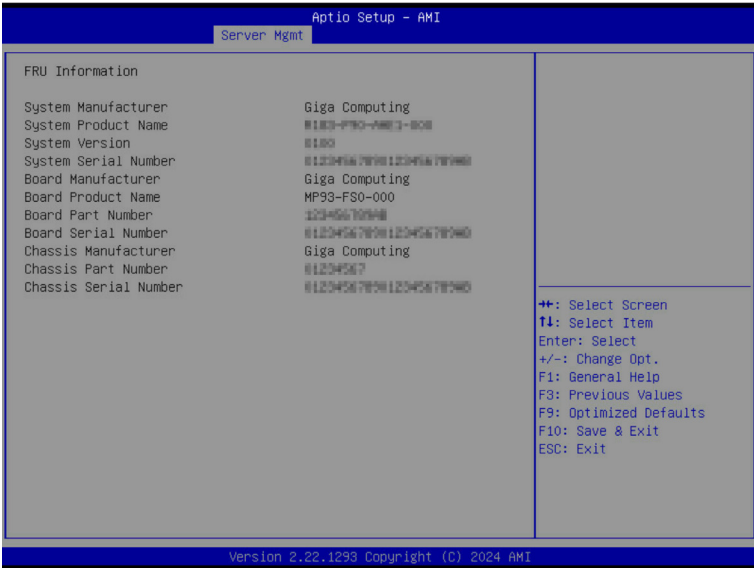

(Note) The model name will vary depends on the product you purchased

5-4-3 Bmc self test log

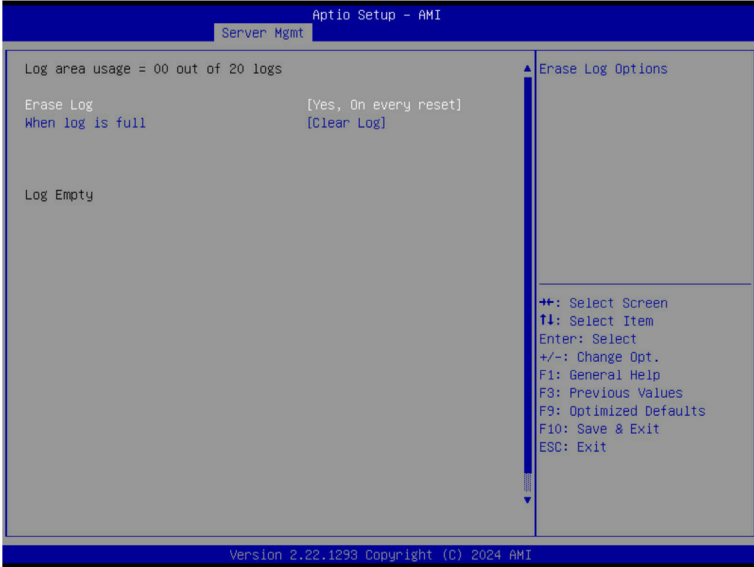

Parameter	Description
Log area usage = 00 out of 20 logs	
Erase Log	Options available: Yes, On every reset/ No. Default setting is No .
When log is full	Options available: Clear Log, Do not log any more. Default setting is Do not log any more .

5-4-4 BMC VLAN Configuration

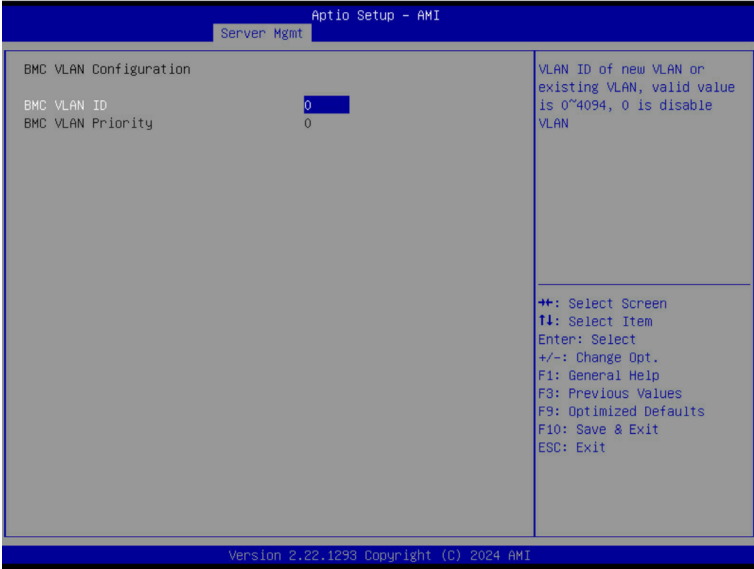

Parameter	Description
BMC VLAN Configuration	
BMC VLAN ID	Select to configure BMC VLAN ID. The valid range is from 0 to 4094. When set to 0, BMC VLAN ID will be disabled.
BMC VLAN Priority	Select to configure BMC VLAN Priority. The valid range is from 0 to 7. When BMC VLAN ID is set to 0, BMC VLAN Priority will not be selected.

5-4-5 BMC Network Configuration

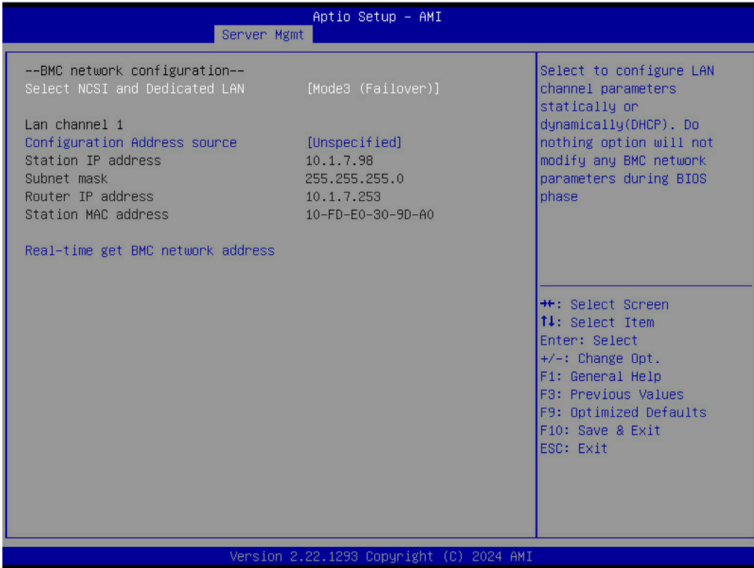

Parameter	Description
BMC network configuration	
Select NCSI and Dedicated LAN	Options available: Mode1 (Dedicated), Mode2 (NCSI), Mode3 (Failover). Default setting is Mode3 (Failover) .
Lan Channel 1	
Configuration Address source	Selects to configure LAN channel parameters statically or dynamically (DHCP). Do nothing option will not modify any BMC network parameters during BIOS phase. Options available: Unspecified, Static, DynamicBmcDhcp. Default setting is DynamicBmcDhcp .
Station IP address	Displays IP Address information.
Subnet mask	Displays Subnet Mask information. Please note that the IP address must be in three digitals, for example, 192.168.000.001.
Router IP address	Displays the Router IP Address information.
Station MAC address	Displays the MAC Address information.
Real-time get BMC network address	Press [Enter] to synchronize the BMC network address.

5-4-6 IPv6 BMC Network Configuration

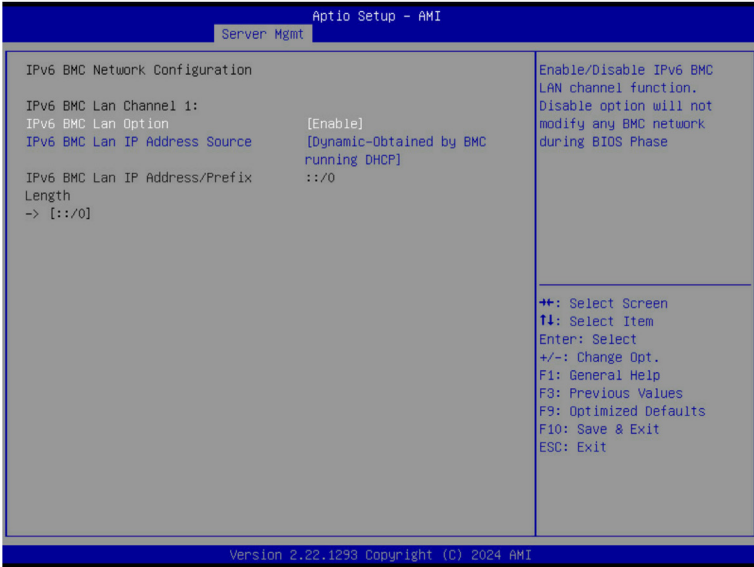

Parameter	Description
IPv6 BMC network configuration	
IPv6 BMC Lan Channel 1	
IPv6 BMC Lan Option	Enable/Disable IPv6 BMC LAN channel function. When this item is disabled, the system will not modify any BMC network during BIOS phase. Options available: Unspecified, Disable, Enable. Default setting is Enable .
IPv6 BMC Lan IP Address Source	Selects to configure LAN channel parameters statically or dynamically (by BIOS or BMC). Options available: Unspecified, Static, Dynamic-Obtained by BMC running DHCP. Default setting is Dynamic-Obtained by BMC running DHCP .
IPv6 BMC Lan IP Address/Prefix Length	Check if the IPv6 BMC LAN IP address matches those displayed on the screen.

5-5 Security Menu

The Security menu allows you to safeguard and protect the system from unauthorized use by setting up access passwords.

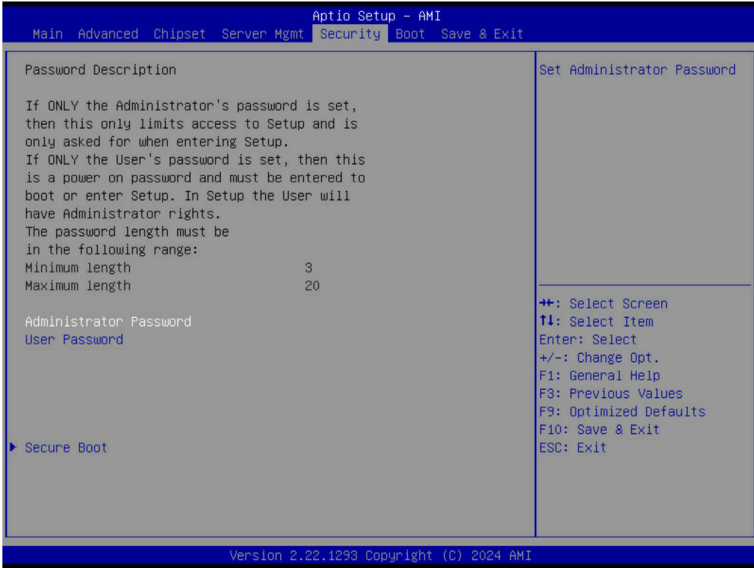

There are two types of passwords that you can set:

- Administrator Password
Entering this password will allow the user to access and change all settings in the Setup Utility.
- User Password
Entering this password will restrict a user's access to the Setup menus. To enable or disable this field, a Administrator Password must first be set. A user can only access and modify the System Time, System Date, and Set User Password fields.

Parameter	Description
Administrator Password	Press [Enter] to configure the administrator password.
User Password	Press [Enter] to configure the user password.
Secure Boot	Press [Enter] to configure advanced items.

5-5-1 Secure Boot

The Secure Boot feature is applicable if supported by your Operating System. If your Operating System is not supporting Secure Boot, the system will hang when starting the Operating System.



Parameter	Description
System Mode	Displays if the system is in User mode or Setup mode.
Secure Boot	Enable/ Disable the Secure Boot function. Options available: Enabled, Disabled. Default setting is Disabled .
Secure Boot Mode ^(Note)	Secure Boot requires all the applications that are running during the booting process to be pre-signed with valid digital certificates. This way, the system knows all files being loaded before the Operating System loads to the login screen have not been tampered with. When set to Standard, it will automatically load the Secure Boot keys from the BIOS databases. When set to Custom, you can customize the Secure Boot settings and manually load its keys from the BIOS database. Options available: Standard, Custom. Default setting is Custom .
Restore Factory Keys	Forces the system to user mode and installs factory default Secure Boot key database.
Reset To Setup Mode	Press [Enter] to reset the system mode to Setup mode.

(Note) Advanced items prompt when this item is set to **Custom**.

Parameter	Description
Key Management	<p data-bbox="335 156 665 180">Press [Enter] to configure advanced items.</p> <p data-bbox="335 185 936 235">Please note that this item is configurable when Secure Boot Mode is set to Custom.</p> <ul style="list-style-type: none"> <li data-bbox="335 243 946 352">◆ Factory Key Provision <ul style="list-style-type: none"> <li data-bbox="367 266 946 321">– Allows to provision factory default Secure Boot keys when system is in Setup Mode. <li data-bbox="367 326 899 352">– Options available: Enabled, Disabled. Default setting is Disabled. <li data-bbox="335 357 931 431">◆ Restore Factory Keys <ul style="list-style-type: none"> <li data-bbox="367 381 931 404">– Installs all factory default keys. It will force the system in User Mode. <li data-bbox="367 409 606 431">– Options available: Yes, No. <li data-bbox="335 435 707 486">◆ Reset to Setup Mode <ul style="list-style-type: none"> <li data-bbox="367 459 707 486">– Reset the system mode to Setup mode. <li data-bbox="335 490 904 572">◆ Enroll Efi Image <ul style="list-style-type: none"> <li data-bbox="367 514 904 572">– Press [Enter] to enroll SHA256 hash of the binary into Authorized Signature Database (db). <li data-bbox="335 577 760 627">◆ Export Secure Boot variables <ul style="list-style-type: none"> <li data-bbox="367 600 760 627">– Export all Secure Boot Keys and key variables. <li data-bbox="335 631 899 682">◆ Secure Boot variable <ul style="list-style-type: none"> <li data-bbox="367 655 899 682">– Displays the current status of the variables used for secure boot. <li data-bbox="335 686 803 791">◆ Platform Key (PK) <ul style="list-style-type: none"> <li data-bbox="367 710 803 736">– Displays the current status of the Platform Key (PK). <li data-bbox="367 741 680 768">– Press [Enter] to configure a new PK. <li data-bbox="367 773 601 791">– Options available: Update. <li data-bbox="335 796 946 932">◆ Key Exchange Keys (KEK) <ul style="list-style-type: none"> <li data-bbox="367 820 946 846">– Displays the current status of the Key Exchange Key Database (KEK). <li data-bbox="367 851 909 901">– Press [Enter] to configure a new KEK or load additional KEK from storage devices. <li data-bbox="367 906 675 932">– Options available: Update, Append. <li data-bbox="335 937 952 1074">◆ Authorized Signatures (DB) <ul style="list-style-type: none"> <li data-bbox="367 961 909 987">– Displays the current status of the Authorized Signature Database. <li data-bbox="367 992 952 1042">– Press [Enter] to configure a new DB or load additional DB from storage devices. <li data-bbox="367 1047 675 1074">– Options available: Update, Append. <li data-bbox="335 1078 904 1215">◆ Forbidden Signatures (DBX) <ul style="list-style-type: none"> <li data-bbox="367 1102 904 1128">– Displays the current status of the Forbidden Signature Database. <li data-bbox="367 1133 899 1183">– Press [Enter] to configure a new dbx or load additional dbx from storage devices. <li data-bbox="367 1188 675 1215">– Options available: Update, Append. <li data-bbox="335 1219 931 1356">◆ Authorized TimeStamps (DBT) <ul style="list-style-type: none"> <li data-bbox="367 1243 931 1270">– Displays the current status of the Authorized TimeStamps Database. <li data-bbox="367 1274 909 1324">– Press [Enter] to configure a new DBT or load additional DBT from storage devices. <li data-bbox="367 1329 675 1356">– Options available: Update, Append.

Parameter	Description
Key Management (continued)	<ul style="list-style-type: none">◆ OsRecovery Signatures<ul style="list-style-type: none">– Displays the current status of the OsRecovery Signature Database.– Press [Enter] to configure a new OsRecovery Signature or load additional OsRecovery Signature from storage devices.– Options available: Update, Append.

5-6 Boot Menu

The Boot menu allows you to set the drive priority during system boot-up. BIOS setup will display an error message if the legacy drive(s) specified is not bootable.

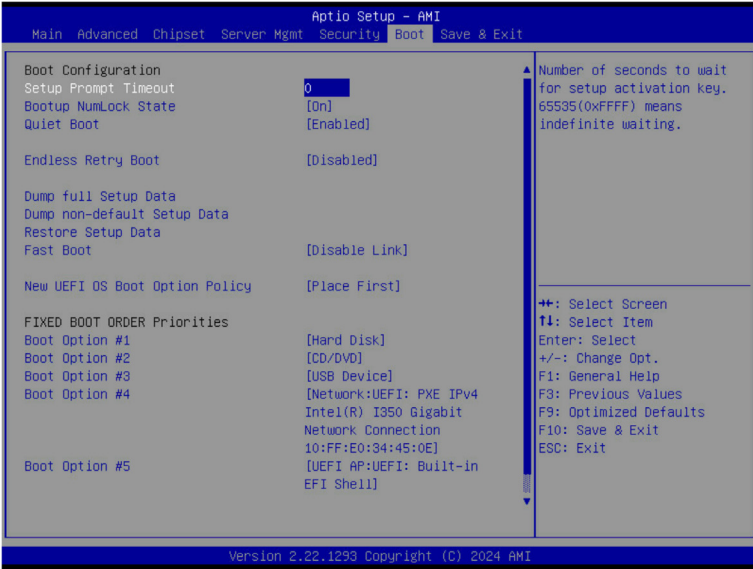

Parameter	Description
Boot Configuration	
Setup Prompt Timeout	Number of seconds to wait for setup activation key. 65535 (0xFFFF) means indefinite waiting. Press the numeric keys to input the desired values.
Bootup NumLock State	Enable/Disable the Bootup NumLock function. Options available: On, Off. Default setting is On .
Quiet Boot	Enable/Disable showing the logo during POST. Options available: Enabled, Disabled. Default setting is Enabled .
Endless Retry Boot	Options available: Disabled, Enabled. Default setting is Disabled .
Dump full Setup Data	Press [Enter] to dump full setup data to file.
Dump non-default Setup Data	Press [Enter] to dump non-default setup data to file.
Restore Setup Data	Press [Enter] to restore setup data from file (cJson format).
Fast Boot	Enable/Disable boot with initialization of a minimal set of devices required to launch active boot option. Has no effect for BBS boot options. Options available: Disable Link, Enabled. Default setting is Disable Link .

Parameter	Description
New UEFI OS Boot Option Policy	Controls the placement of newly detected UEFI boot options. Options available: Default, Place First, Place Last. Default setting is Place First .
FIXED BOOT ORDER Priorities	
Boot Option #1 / #2 / #3 / #4 / #5	Press [Enter] to configure the boot priority. By default, the server searches for boot devices in the following sequence: <ol style="list-style-type: none"> 1. Hard drive. 2. CD-COM/DVD drive. 3. USB device. 4. Network. 5. UEFI.
UEFI Network Drive BBS Priorities	Press [Enter] to configure the boot priority.
UEFI Application Boot Priorities	Press [Enter] to configure the boot priority.

5-7 Save & Exit Menu

The Save & Exit menu displays the various options to quit from the BIOS setup. Highlight any of the exit options then press <Enter>.

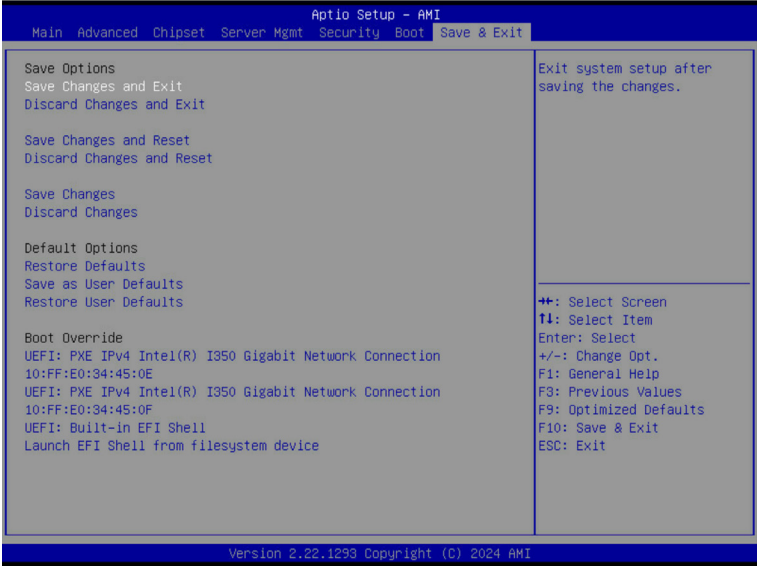

Parameter	Description
Save Options	
Save Changes and Exit	Saves changes made and closes the BIOS setup. Options available: Yes, No.
Discard Changes and Exit	Discards changes made and exits the BIOS setup. Options available: Yes, No.
Save Changes and Reset	Restarts the system after saving the changes made. Options available: Yes, No.
Discard Changes and Reset	Restarts the system without saving the changes made. Options available: Yes, No.
Save Changes	Saves changes done so far to any of the setup options. Options available: Yes, No.
Discard Changes	Options available: Yes, No.
Default Options	

Parameter	Description
Restore Defaults	<p>Loads the default settings for all BIOS setup parameters. Setup Defaults are quite demanding in terms of resources consumption. If you are using low-speed memory chips or other kinds of low-performance components and you choose to load these settings, the system might not function properly.</p> <p>Options available: Yes, No.</p>
Save as User Defaults	<p>Press [Enter] to save changes as the user defaults without exit BIOS setup.</p>
Restore User Defaults	<p>Press [Enter] to restore the user defaults .</p>
Boot Override	<p>Press [Enter] to configure the device as the boot-up drive.</p>
Launch EFI Shell from filesystem device	<p>Attempts to Launch EFI Shell application (Shell.efi) from one of the available file system devices.</p>

5-8 BIOS Recovery

The system has an embedded recovery technique. In the event that the BIOS becomes corrupt the boot block can be used to restore the BIOS to a working state. To restore your BIOS, please follow the instructions listed below:

Recovery Instruction:

1. Copy the XXX.rom to USB diskette.
2. Setting BIOS Recovery jump to enabled status.
3. Boot into BIOS recovery.
4. Run Proceed with flash update.
5. BIOS updated.

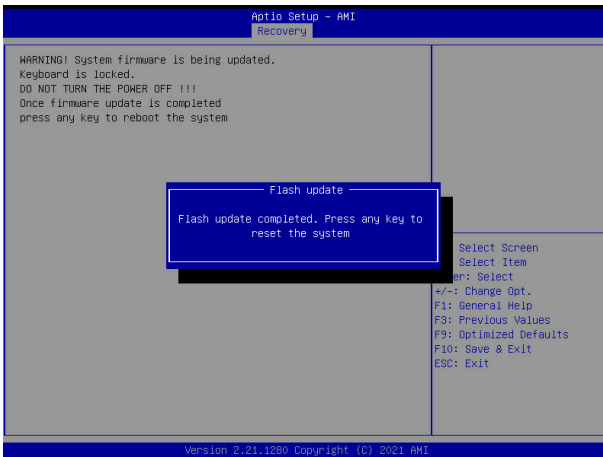

5-9 BIOS POST Beep code (AMI standard)

5-9-1 PEI Beep Codes

# of Beeps	Description
1	Memory not Installed.
1	Memory was installed twice (InstallPeiMemory routine in PEI Core called twice)
2	Recovery started
3	DXE IPL was not found
3	DXE Core Firmware Volume was not found
4	Recovery failed
4	S3 Resume failed
7	Reset PPI is not available

5-9-2 DXE Beep Codes

# of Beeps	Description
1	Invalid password
4	Some of the Architectural Protocols are not available
5	No Console Output Devices are found
5	No Console Input Devices are found
6	Flash update is failed
7	Reset protocol is not available
8	Platform PCI resource requirements cannot be met