

# **GIGABYTE™**

## **MS74-HB0**

Motherboard - Intel® Xeon® 6 Processors - E-ATX DP

User Manual

Rev. 1.0

## **Copyright**

© 2024 Giga Computing TECHNOLOGY CO., LTD. All rights reserved.

The trademarks mentioned in this manual are legally registered to their respective owners.

## **Disclaimer**

Information in this manual is protected by copyright laws and is the property of GIGABYTE.

Changes to the specifications and features in this manual may be made by Giga Computing without prior notice. No part of this manual may be reproduced, copied, translated, transmitted, or published in any form or by any means without Giga Computing's prior written permission.

## **Documentation Classifications**

In order to assist in the use of this product, Giga Computing provides the following types of documentation:

- User Manual: detailed information & steps about the installation, configuration and use this product (e.g. motherboard, server barebones), covering hardware and BIOS.
- User Guide: detailed information about the installation & use of an add-on hardware or software component (e.g. BMC firmware, rail-kit) compatible with this product.
- Quick Installation Guide: a short guide with visual diagrams that you can reference easily for installation purposes of this product (e.g. motherboard, server barebones).

Please see the support section of the online product page to check the current availability of these documents

## **For More Information**

For related product specifications, the latest firmware and software, and other information, please visit our website at: <http://www.gigabyte.com/enterprise>.

For GIGABYTE distributors and resellers, additional sales & marketing materials are available from our reseller portal: <http://reseller.b2b.gigabyte.com>

For further technical assistance, please contact your GIGABYTE representative or visit <http://esupport.gigabyte.com/> to create a new support ticket.

For any general sales or marketing enquires, you may message GIGABYTE server directly by email: [server.grp@gigabyte.com](mailto:server.grp@gigabyte.com).

**⚠ WARNING**

- **INGESTION HAZARD:** This product contains a button cell or coin battery.
- **DEATH** or serious injury can occur if ingested.
- A swallowed button cell or coin battery can cause **Internal Chemical Burns** in as little as **2 hours**.
- **KEEP** new and used batteries **OUT OF REACH OF CHILDREN**
- **Seek immediate medical attention** if a battery is suspected to be swallowed or inserted inside any part of the body.



- Battery type: CR2032, voltage rating: +3VDC.
- Non-rechargeable batteries are not to be recharged.
- Remove and immediately recycle or dispose of used batteries, batteries from equipment not used for an extended period of time according to local regulations and keep away from children. Do NOT dispose of batteries in household trash or incinerate.
- Even used batteries may cause severe injury or death.
- Do not force discharge, recharge, disassemble, heat above (manufacturer's specified temperature rating) or incinerate. Doing so may result in injury due to venting, leakage or explosion resulting in chemical burns.
- For treatment information, call a local poison control center.
- The product contains non-replaceable batteries.

# Table of Contents

Block Diagram .....	6
Chapter 1 Hardware Installation .....	7
1-1 Installation Precautions .....	7
1-2 Product Specifications .....	8
1-3 Installing and Removing the CPU .....	11
1-4 Installing and Removing Memory .....	13
1-4-1 4-Channel Memory Configuration .....	13
1-4-2 Installing and Removing a Memory Module .....	14
1-4-3 DIMM Population Table .....	14
Processor and Memory Module Matrix Table .....	15
1-5 Installing the M.2 SSD Module .....	16
1-6 Back Panel Connectors .....	17
1-7 Internal Connectors .....	19
1-8 Jumper Settings .....	29
Chapter 5 BIOS Setup .....	30
5-1 The Main Menu .....	32
5-2 Advanced Menu .....	35
5-2-1 Trusted Computing .....	36
5-2-2 Serial Port Console Redirection .....	37
5-2-3 SIO Configuration .....	40
5-2-4 PCI Subsystem Settings .....	41
5-2-5 USB Configuration .....	43
5-2-6 Network Stack Configuration .....	44
5-2-7 Post Report Configuration .....	45
5-2-8 KMIP Server Configuration .....	46
5-2-9 NVMe Configuration .....	47
5-2-10 Chipset Configuration .....	49
5-2-11 Tls Auth Configuration .....	51
5-2-12 iSCSI Configuration .....	54
5-2-13 Intel(R) I210 Gigabit Network Connection .....	55
5-2-14 VLAN Configuration .....	57
5-3 Chipset Menu .....	58
5-3-1 Processor Configuration .....	59
5-3-2 Common RefCode Configuration .....	62
5-3-3 UPI Configuration .....	63
5-3-4 Memory Configuration .....	66
5-3-5 IIO Configuration .....	72

5-3-6	Advanced Power Management Configuration .....	77
5-3-7	Miscellaneous Configuration .....	83
5-3-8	Runtime Error Logging Settings .....	84
5-3-9	Power Policy.....	86
5-4	Server Management Menu.....	88
5-4-1	System Event Log .....	90
5-4-2	View FRU Information .....	91
5-4-3	BMC VLAN Configuration.....	92
5-4-4	BMC Network Configuration.....	93
5-4-5	IPv6 BMC Network Configuration.....	94
5-5	Security Menu .....	95
5-5-1	Secure Boot .....	96
5-6	Boot Menu.....	99
5-7	Save & Exit Menu.....	101
5-8	BIOS Recovery .....	103
5-9	BIOS POST Beep code (AMI standard).....	104
5-9-1	PEI Beep Codes .....	104
5-9-2	DXE Beep Codes .....	104

# Block Diagram

1-Channel DDR5, 8 x DIMMs  
 RDIMM: Up to 6400 MT/s  
 MCR DIMM: Up to 8000 MT/s

8-Channel DDR5, 8 x DIMMs  
 RDIMM: Up to 6400 MT/s  
 MCR DIMM: Up to 8000 MT/s

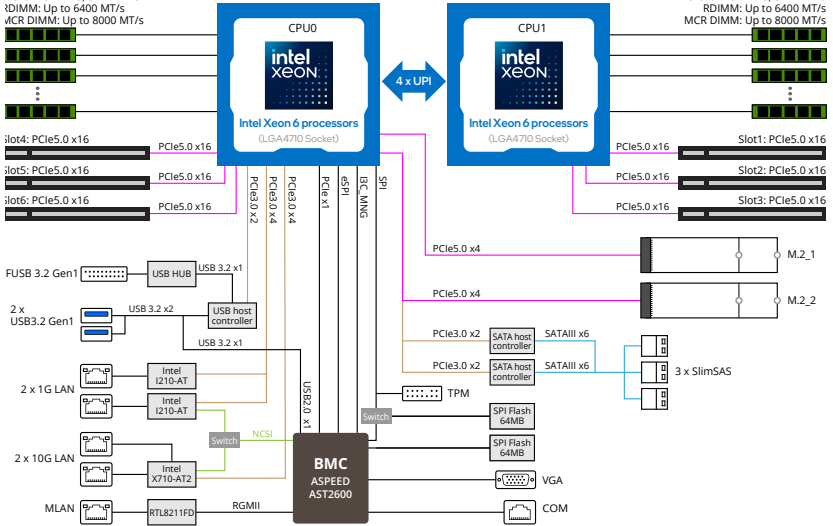











# Chapter 1 Hardware Installation

## 1-1 Installation Precautions





The motherboard contains numerous delicate electronic circuits and components which can become damaged as a result of electrostatic discharge (ESD). Prior to installation, carefully read the user's manual and follow these procedures:



- Prior to installation, do not remove or break motherboard S/N (Serial Number) sticker or warranty sticker provided by your dealer. These stickers are required for warranty validation.
- Always remove the AC power by unplugging the power cord from the power outlet before installing or removing the motherboard or other hardware components.
- When connecting hardware components to the internal connectors on the motherboard, make sure they are connected tightly and securely.
- When handling the motherboard, avoid touching any metal leads or connectors.
- It is best to wear an electrostatic discharge (ESD) wrist strap when handling electronic components such as a motherboard, CPU or memory. If you do not have an ESD wrist strap, keep your hands dry and first touch a metal object to eliminate static electricity.
- Prior to installing the motherboard, please have it on top of an antistatic pad or within an electrostatic shielding container.
- Before unplugging the power supply cable from the motherboard, make sure the power supply has been turned off.
- Before turning on the power, make sure the power supply voltage has been set according to the local voltage standard.
- Before using the product, please verify that all cables and power connectors of your hardware components are connected.
- To prevent damage to the motherboard, do not allow screws to come in contact with the motherboard circuit or its components.
- Make sure there are no leftover screws or metal components placed on the motherboard or within the computer casing.
- Do not place the computer system on an uneven surface.
- Do not place the computer system in a high-temperature environment.
- Turning on the computer power during the installation process can lead to damage to system components as well as physical harm to the user.
- If you are uncertain about any installation steps or have a problem related to the use of the product, please consult a certified computer technician.

## 1-2 Product Specifications

	CPU	<ul style="list-style-type: none"> <li>◆ Intel® Xeon® 6 Processors               <ul style="list-style-type: none"> <li>- Intel® Xeon® 6700E-Series Processors</li> <li>- Intel® Xeon® 6700P-Series Processors (available Q1'25)</li> <li>- Intel® Xeon® 6500P-Series Processors (available Q1'25)</li> </ul> </li>   <li>◆ Dual processor, TDP up to 350W</li> </ul>
<p>[Note] If only 1 CPU is installed, some PCIe or memory functions might be unavailable.</p>		
	Form Factor	<ul style="list-style-type: none"> <li>◆ ATX</li> <li>◆ 304.8W x 244D (mm)</li> </ul>
	Socket	<ul style="list-style-type: none"> <li>◆ 2 x LGA 4710</li> <li>◆ Socket E2</li> </ul>
	Chipset	<ul style="list-style-type: none"> <li>◆ System on Chip</li> </ul>
	Memory Type	<ul style="list-style-type: none"> <li>◆ 16 x DIMM slots</li> <li>◆ DDR5 memory supported</li> <li>◆ 8-Channel memory architecture</li> <li>◆ MCR DIMM supported <sup>[1]</sup></li> <li>◆ RDIMM: Up to 6400 MT/s</li> <li>◆ MCR DIMM: Up to 8000 MT/s</li> </ul> <p>[1] MCR DIMMs are only supported with Intel® Xeon® 6 Processors with P-cores.</p>
	Integrated Network	<ul style="list-style-type: none"> <li>◆ 2 x 10Gb/s LAN (1 x Intel® X710-AT2)</li> <li>◆ 2 x 1Gb/s LAN (2 x Intel® I210-AT)               <ul style="list-style-type: none"> <li>- Support NCSI function</li> </ul> </li>   <li>◆ 1 x 10/100/1000 Mbps Management LAN</li> </ul>
	Integrated Video Controller	<ul style="list-style-type: none"> <li>◆ Integrated in Aspeed® AST2600               <ul style="list-style-type: none"> <li>- 1 x VGA port</li> </ul> </li> </ul>
	Integrated Audio Controller	<ul style="list-style-type: none"> <li>◆ N/A</li> </ul>
	Storage Interface	<ul style="list-style-type: none"> <li>◆ <b>SlimSAS:</b> <ul style="list-style-type: none"> <li>- 3 x SlimSAS 4i for 12 x SATA 6Gb/s, from CPU_0</li> </ul> </li> <li>◆ <b>M.2:</b> <ul style="list-style-type: none"> <li>- 2 x M.2 (2280/22110), PCIe Gen5 x4, from CPU_0</li> </ul> </li> </ul>
	Support RAID Function	<ul style="list-style-type: none"> <li>◆ Onboard VROC key header</li> </ul>



	Expansion Slots	<ul style="list-style-type: none"> <li>◆ Slot_6: PCIe x16 (Gen5 x16), from CPU_0</li> <li>◆ Slot_5: PCIe x16 (Gen5 x16), from CPU_0</li> <li>◆ Slot_4: PCIe x16 (Gen5 x16), from CPU_0</li> <li>◆ Slot_3: PCIe x16 (Gen5 x16), from CPU_1</li> <li>◆ Slot_2: PCIe x16 (Gen5 x16), from CPU_1</li> <li>◆ Slot_1: PCIe x16 (Gen5 x16), from CPU_1</li> </ul>
	On-Board Connectors	<ul style="list-style-type: none"> <li>◆ 1 x 24-pin ATX main power connector</li> <li>◆ 2 x 8-pin ATX 12V power connectors</li> <li>◆ 2 x 6-pin ATX 12V power connectors</li> <li>◆ 2 x CPU fan headers</li> <li>◆ 5 x System fan headers</li> <li>◆ 1 x USB 3.2 Gen1 x2 header</li> <li>◆ 2 x M.2 slots</li> <li>◆ 3 x SlimSAS connectors</li> <li>◆ 1 x VROC connector</li> <li>◆ 1 x NCSI connector</li> <li>◆ 1 x Front panel header</li> <li>◆ 1 x Backplane board header</li> <li>◆ 1 x PMBus header</li> <li>◆ 1 x IPMB header</li> <li>◆ 1 x TPM header</li> <li>◆ 1 x PRoT connector (<b>only enabled on RoT SKU</b>)</li> </ul>
	Rear I/O Connectors	<ul style="list-style-type: none"> <li>◆ 2 x USB 3.2 Gen1 ports (Type-A)</li> <li>◆ 1 x VGA port</li> <li>◆ 1 x RJ45 serial port</li> <li>◆ 4 x RJ45 ports</li> <li>◆ 1 x MLAN port</li> <li>◆ 1 x ID button with LED</li> </ul>
	Security Modules	<ul style="list-style-type: none"> <li>◆ 1 x TPM header with SPI interface</li> <li>- <b>Optional</b> TPM2.0 kit: CTM012</li> <li>◆ 1 x PRoT connector (<b>only enabled on RoT SKU</b>)</li> </ul>
	OS Driver Supported	<ul style="list-style-type: none"> <li>◆ Please refer to OS compatibility table in support page</li> </ul>

	Server Management	<ul style="list-style-type: none"> <li>◆ Aspeed® AST2600 Baseboard Management Controller</li> <li>◆ GIGABYTE Management Console web interface</li> <li>◆</li> <li>◆ Dashboard</li> <li>◆ HTML5 KVM</li> <li>◆ Sensor Monitor (Voltage, RPM, Temperature, CPU Status ...etc.)</li> <li>◆ Sensor Reading History Data</li> <li>◆ FRU Information</li> <li>◆ SEL Log in Linear Storage / Circular Storage Policy</li> <li>◆ Hardware Inventory</li> <li>◆ Fan Profile</li> <li>◆ System Firewall</li> <li>◆ Power Consumption</li> <li>◆ Power Control</li> <li>◆ Advanced power capping</li> <li>◆ LDAP / AD / RADIUS Support</li> <li>◆ Backup &amp; Restore Configuration</li> <li>◆ Remote BIOS/BMC/CPLD Update</li> <li>◆ Event Log Filter</li> <li>◆ User Management</li> <li>◆ Media Redirection Settings</li> <li>◆ PAM Order Settings</li> <li>◆ SSL Settings</li> <li>◆ SMTP Settings</li> </ul>
	PSU Connectors	<ul style="list-style-type: none"> <li>◆ 1 x 24-pin ATX main power connector</li> <li>◆ 2 x 8-pin ATX 12V power connectors</li> <li>◆ 2 x 6-pin ATX 12V power connectors</li> </ul>
	Operating Properties	<ul style="list-style-type: none"> <li>◆ Operating temperature: 10°C to 40°C</li> <li>◆ Operating humidity: 8-80% (non-condensing)</li> <li>◆ Non-operating temperature: -40°C to 60°C</li> <li>◆ Non-operating humidity: 20%-95% (non-condensing)</li> </ul>
<p>GIGABYTE reserves the right to make any changes to the product specifications and product-related information without prior notice.</p>		

## 1-3 Installing and Removing the CPU



Read the following guidelines before you begin to install the CPU:

- Make sure that the motherboard supports the CPU.
- Always turn off the computer and unplug the power cord from the power outlet before installing the CPU to prevent hardware damage.
- Unplug all cables from the power outlets.
- Disconnect all telecommunication cables from their ports.
- Place the system unit on a flat and stable surface.
- Open the system according to the instructions.

### **WARNING!**

Failure to properly turn off the server before you start installing components may cause serious damage. Do not attempt the procedures described in the following sections unless you are a qualified service technician.

### **Follow these instructions to Install the CPU:**

1. Align and install the processor on the carrier.  
**NOTE:** Apply thermal compound evenly on the top of the CPU. Remove the protective cover from the underside of the heat sink.
2. Carefully flip the heat sink cover. Then install the carrier assembly on the bottom of the heat sink and make sure the gold arrow is located in the correct direction.
3. Remove the CPU cover.  
**NOTE:** Save the CPU cover in the event that you need to remove the CPU from the socket.
4. Align the heat sink with the CPU socket by the guide pins and make sure the gold arrow is located in the correct direction. Then place the heat sink onto the top of the CPU socket.
5. Position the rotating wires into the latch position. Tighten the screws in a sequential order (1→2→3→4).

**NOTE:** When disassembling the heat sink, loosen the screws in reverse order (4→3→2→1) and then move the rotating wires into the unlatch position.

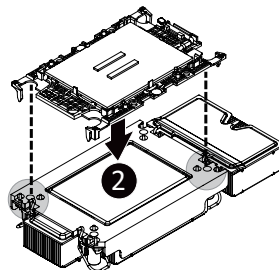
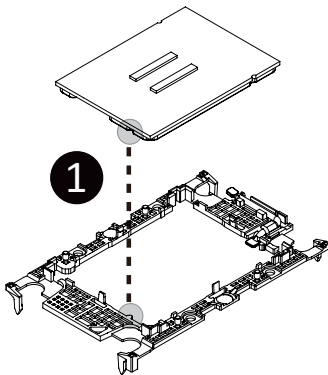

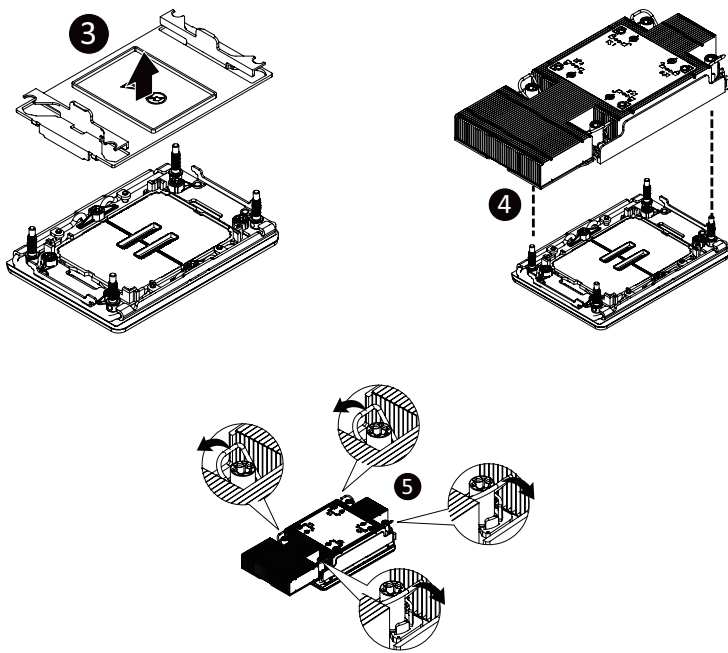

### Carrier Types used for Package Types

Package Type	Granite Rapids-SP XCC	Granite Rapids-SP HCC Granite Rapids-SP LCC Sierra Forest-SP Clearwater Forest-SP
Carrier Code	E2A	E2B
Shim?	No	Yes
Integrated TIM Break Lever	Yes	Yes

#### NOTE!

- The carrier code is marked on each carrier and matches a code laser marked on to the IHS(Integrated Heat Spreader) to ensure the right parts are used together
- When installing the heat sink to CPU, use T30-Lobe driver to tighten 4 captive nuts in sequence as 1-4.
- The screw tightening torque:  $8 \pm 0.5$  kgf-cm.

## 1-4 Installing and Removing Memory



Read the following guidelines before you begin to install the memory:

- Make sure that the motherboard supports the memory. It is recommended to use memory of the same capacity, brand, speed, and chips.
- Always turn off the computer and unplug the power cord from the power outlet before installing the memory to prevent hardware damage.
- Memory modules have a foolproof design. A memory module can be installed in only one direction. If you are unable to insert the memory, switch the direction.

### 1-4-1 4-Channel Memory Configuration

This motherboard provides 16 DDR5 memory slots and supports 8-Channel Technology. After the memory is installed, the BIOS will automatically detect the specifications and capacity of the memory.

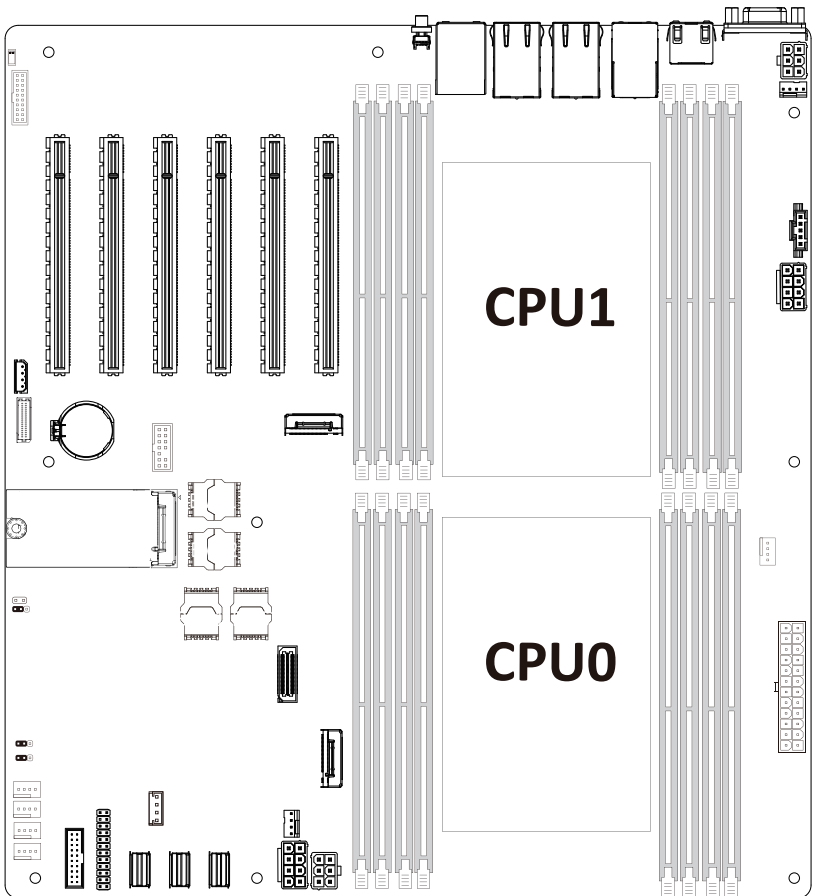

## 1-4-2 Installing and Removing a Memory Module



Before installing a memory module, make sure to turn off the computer and unplug the power cord from the power outlet to prevent damage to the memory module. Be sure to install DDR5 DIMMs on this motherboard.

Follow these instructions to install a DIMM module:

1. Insert the DIMM memory module vertically into the DIMM slot and push it down.
2. Close the plastic clip at both edges of the DIMM slots to lock the DIMM module.
3. Reverse the installation steps when you want to remove the DIMM module.

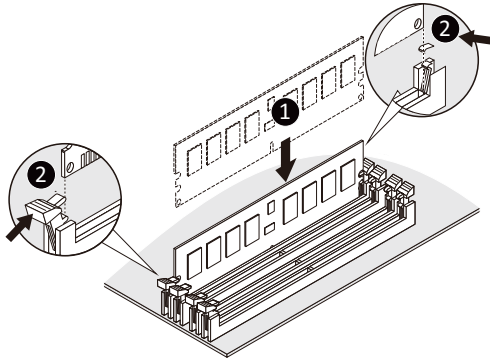

## 1-4-3 DIMM Population Table

Type	Ranks Per DIMM and Data Width	DIMM Capacity (GB)	Speed (MT/s); Voltage (V); DIMM per Channel (DPC)	
			1DPC*	2DPC*
		16Gb	1.1V	
RDIMM	SRx8 (RC D)	16GB	4800	4400
	SRx4 (RC C)	32GB		
	DRx8 (RC E)	32GB		
	DRx4 (RC A)	64GB		
RDIMM 3DS	(4R/8R)x4	2H-128GB		
	(RC A)	4H-256GB		

\*1DPC applies to 1SPC or 2SPC implementations (SPC - Sockets Per Channel)

## 5th Gen Intel Xeon Scalable Processors-SP Memory Support

Type	Ranks Per DIMM and Data Width	DIMM Capacity (GB)			Speed (MT/s); Voltage (V); DIMM per Channel (DPC)	
		16Gb	24Gb <sup>2</sup>	36Gb	1DPC <sup>1</sup>	2DPC
					1.1V	
RDIMM	SRx8 (RC D)	16GB	24GB	NA	5600 <sup>3</sup>	4400 <sup>3</sup>
	SRx4 (RC C)	32GB	48GB	NA		
	SRx4 (RC F) 9x4	NA	NA	NA		
	DRx8 (RC E)	32GB	48GB	NA		
	DRx4 (RC A)	64GB	96GB	128GB		
	DRx4 (RC B) 9x4	NA	NA	NA		
RDIMM 3DS	(4R/8R)x4 (RC A)	2H-128GB 4H-256GB	NA	NA	5600 <sup>4</sup>	

**NOTE:**

- 1DPC applies to 1SPC or 2SPC implementations (SPC - Sockets Per Channel)
- 24Gb 2DPC not POR w/ 24GB and 48GB DIMMs.
- DDR5-5600 RDIMMs will be limited to 5600 MT/s 1DPC and 4400 MT/s 2DPC. DDR5-4800 DIMMs will be limited to 4800 MT/s 1DPC and 4400 MT/s 2DPC.
- DDR5-5600 DIMMs are required for 5600 and 5200 1DPC speeds.

## Processor and Memory Module Matrix Table

**NOTE!**

- Xeon 6700E/6500E-series do not support 12 DIMMs Configuration.

Memory Q'ty for each CPU	CPU0															
	H0	H1	G0	G1	F0	F1	E0	E1	A1	A0	B1	B0	C1	C0	D1	D0
	CPU1															
	P0	P1	O0	O1	N0	N1	M0	M1	I1	I0	J1	J0	K1	K0	L1	L0
1 DIMM										v						
4 DIMM			v				v			v				v		
	v				v							v				v
8 DIMM	v		v		v		v		v		v		v		v	
			v	v			v	v	v				v	v		
	v	v			v	v					v	v			v	v
12 DIMM	v		v	v	v		v	v	v	v		v	v	v	v	v
16 DIMM	v	v	v	v	v	v	v	v	v	v	v	v	v	v	v	v

## 1-5 Installing the M.2 SSD Module

Follow the steps below to install a M.2 SSD module on your motherboard.

Step1. Insert the M.2 SSD module into the slot.

Step2. Secure it with the screw, tightening as necessary to fasten the M.2 SSD module in place.

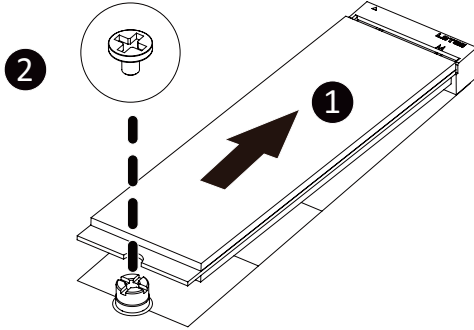



## 1-6 Back Panel Connectors

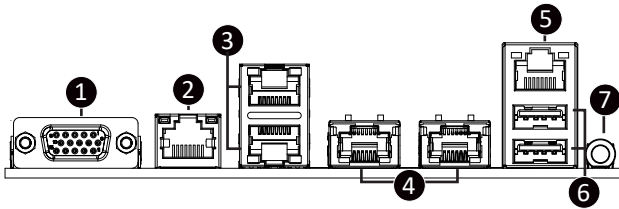

### 1 VGA Port

Connect to a monitor device.

### 2 Serial Port (RJ45 Type)

Connect to serial-based mouse or data processing devices.

### 3 LAN Port #3 / LAN Port #4

The Gigabit Ethernet LAN port provides Internet connection at up to 10 GbE data rate. See the section below for a description of the states of the LAN port LEDs.

### 4 LAN Port #2 / LAN Port #1

The Gigabit Ethernet LAN port provides Internet connection at up to 1 GbE data rate. See the section below for a description of the states of the LAN port LEDs.

### 5 Server Management 10/100/1000 LAN Port

The LAN port provides Internet connection with data transfer speeds of 10/100/1000Mbps. This port is the dedicated LAN port for Server Management.

### 6 USB 3.2 Gen1 Ports

The USB port supports the USB 3.2 specification. Use this port for USB devices such as a USB keyboard/mouse, USB printer, USB flash drive etc.

### 7 ID Button with LED

When the system identification is active, the ID LED on the front/ back panel glows blue.

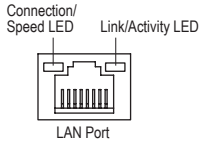

10/100/1000 LAN LED:

State	Description
Yellow On	1 Gbps data rate
Green On	100 Mbps data rate
Off	10 Mbps data rate

ID Button / LED:

State	Description
Blue on	System identification is active
Off	System identification is disable



- When removing the cable connected to a back panel connector, first remove the cable from your device and then remove it from the motherboard.
- When removing the cable, pull it straight out from the connector. Do not rock it side to side to prevent an electrical short inside the cable connector.

# 1-7 Internal Connectors

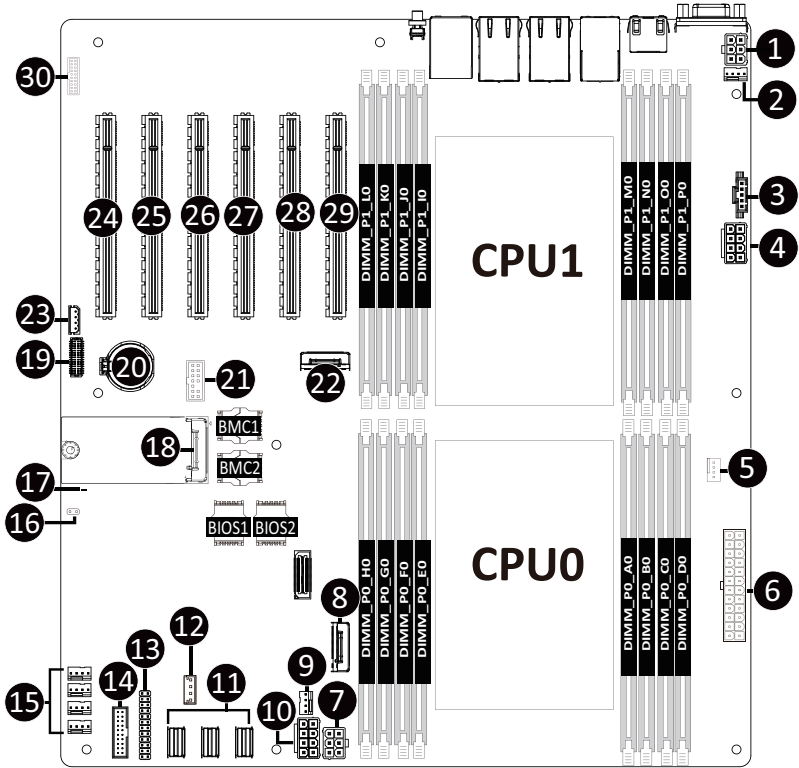

No.	Code	Description	No.	Code	Description
1	P12V_PCIE2	2x3 Pin 12V Power Connector	16	CASE_OPEN	Case Open Intrusion Header
2	CPU0_FAN	CPU0 Fan Connector	17	LED_BMC	BMC Firmware Readiness LED
3	PMBUS	PMBus Connector	18	PROT_Conn.	PRoT Module Connector
4	P12V_AUX	2x4 Pin 12V Power Connector	19	BP_1	HDD Backplane Board Connector
5	SYS_FAN1	System Fan Connector #1/#2/#3/#4	20	BAT	Battery Socket
6	ATX	2x12 Pin Main Power Connector	21	SPL_TPM	TPM Connector
7	P12V_PCIE1	2x3 Pin 12V Power Connector	22	M2_1	M.2 Slot (PCIe Gen5 x2, Support NGFF-2280/22110)
8	M2_0	M.2 Slot (PCIe Gen5 x2, Support NGFF-2280/22110)	23	IPMB	Intelligent Platform Management Bus Connector
9	CPU1_FAN	CPU1 Fan Connector	24	PCIE_1	PCIe x16 Slot (Gen5 x16)
10	P12V_AUX1	2x4 Pin 12V Power Connector	25	PCIE_2	PCIe x16 Slot (Gen5 x16)
11	SL_SATA3/SATA1/SATA2	Slimline Connector #3/#1/#2 (SATA 6Gb/s Signal)	26	PCIE_3	PCIe x16 Slot (Gen5 x16)
12	SW_RAID	SATA RAID Upgrade Key (VROC Module Connector)	27	PCIE_4	PCIe x16 Slot (Gen5 x16)
13	FP_1	Front Panel Header	28	PCIE_5	PCIe x16 Slot (Gen5 x16)
14	F_USB3	Front Panel USB 3.2 Gen1 Connector	29	PCIE_6	PCIe x16 Slot (Gen5 x16)
15	FAN3/FAN2/FAN4/FAN5	System Fan Connector #3/#2/#4/#5	30	CN_NCSI	NCSI Connector



Read the following guidelines before connecting external devices:

- First make sure your devices are compliant with the connectors you wish to connect.
- Before installing the devices, be sure to turn off the devices and your computer. Unplug the power cord from the power outlet to prevent damage to the devices.
- After installing the device and before turning on the computer, make sure the device cable has been securely attached to the connector on the motherboard.

## 1/4/6/7/10) P12V\_PCIE2/P12V\_AUX/ATX/P12V\_PCIE1/P12V\_AUX1 (2x3, 2x4 12V Power Connector and 2x12 Main Power Connector)

With the use of the power connector, the power supply can supply enough stable power to all the components on the motherboard. Before connecting the power connector, first make sure the power supply is turned off and all devices are properly installed. The power connector possesses a foolproof design. Connect the power supply cable to the power connector in the correct orientation. The 12V power connector mainly supplies power to the CPU. If the 12V power connector is not connected, the computer will not start.



To meet expansion requirements, it is recommended that a power supply that can withstand high power consumption be used (500W or greater). If a power supply is used that does not provide the required power, the result can lead to an unstable or unbootable system.

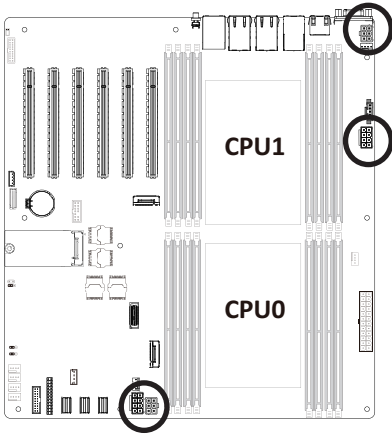

**P12V\_AUX1/ P12V\_AUX2**

Pin No.	Definition
1	GND
2	GND
3	GND
4	GND
5	+12V
6	+12V
7	+12V
8	+12V



**P12V\_PCIE2**

Pin No.	Definition
1	+12V
2	+12V
3	+12V
4	GND
5	GND
6	GND



**ATX**

Pin No.	Definition	Pin No.	Definition
1	3.3V	13	3.3V
2	3.3V	14	-12V
3	GND	15	GND
4	+5V	16	PS_ON
5	GND	17	GND
6	+5V	18	GND
7	GND	19	GND
8	Power Good	20	NC
9	5VSB	21	+5V
10	+12V	22	+5V
11	+12V	23	+5V
12	3.3V	24	GND

## 2/5/9/15) CPU0\_FAN/SYS\_FAN1/CPU1\_FAN/SYS\_FAN3/SYS\_FAN2/SYS\_FAN4/SYS\_FAN5 (CPU Fan/System Fan Headers)

The motherboard has one 4-pin CPU fan header (CPU\_FAN), and two 4-pin (SYS\_FAN) system fan headers. Most fan headers possess a foolproof insertion design. When connecting a fan cable, be sure to connect it in the correct orientation (the black connector wire is the ground wire). The motherboard supports CPU fan speed control, which requires the use of a CPU fan with fan speed control design. For optimum heat dissipation, it is recommended that a system fan be installed inside the chassis.

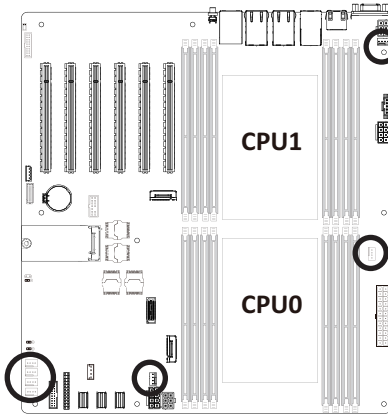

Pin No.	Definition
1	GND
2	+12V
3	Sense
4	Speed Control



- Be sure to connect fan cables to the fan headers to prevent your CPU and system from overheating. Overheating may result in damage to the CPU or the system may hang.
- These fan headers are not configuration jumper blocks. Do not place a jumper cap on the headers.

### 3) PMBus Connector

The Power Management Bus (PMBus) is a variant of the System Management Bus (SMBus) which is targeted at digital management of power supplies.

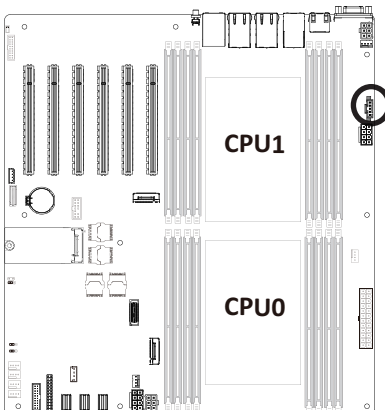

Pin No.	Definition
1	PMBus Clock
2	PMBus Data
3	PMBus Alert
4	GND
5	3.3V Sense

### 13) FP\_1 (Front Panel Header)

Connect the power switch, reset switch, speaker, chassis intrusion switch/sensor and system status indicator on the chassis to this header according to the pin assignments below. Note the positive and negative pins before connecting the cables.

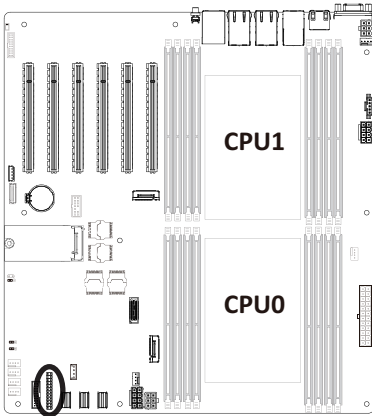

Pin No.	Definition	Pin No.	Definition
1	Power LED+	2	5V Standby
3	No Pin	4	ID LED+
5	Power LED-	6	ID LED-
7	HDD LED+	8	System Status LED+
9	HDD LED-	10	System Status LED-
11	Power Button	12	LAN1 Active LED+
13	GND	14	LAN1 Link LED-
15	Reset Button	16	SMBus Data
17	GND	18	SMBus Clock
19	ID Button	20	Case Open
21	GND	22	LAN2 Active LED+
23	NMI Switch	24	LAN2 Link LED-



The front panel design may differ by chassis. A front panel module mainly consists of power switch, reset switch, power LED, hard drive activity LED, speaker etc. When connecting your chassis front panel module to this header, make sure the wire assignments and the pin assignments are matched correctly.

### 14) F\_USB3 (Front Panel USB 3.2 Gen1 Connector)

The connectors conform to USB 3.2 specification. Each USB header can provide two USB ports via an optional USB bracket. For purchasing the optional USB bracket, please contact the local dealer.

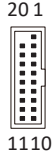
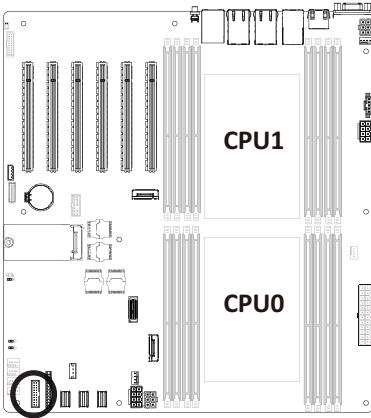

USB 3.2 Connector

Pin No.	Definition	Pin No.	Definition
1	Power	11	IntA_P2_D+
2	IntA_P1_SSRX-	12	IntA_P2_D-
3	IntA_P1_SSRX+	13	GND
4	GND	14	IntA_P2_SSTX+
5	IntA_P1_SSTX-	15	IntA_P2_SSTX-
6	IntA_P1_SSTX+	16	GND
7	GND	17	IntA_P2_SSRX+
8	IntA_P1_D-	18	IntA_P2_SSRX-
9	IntA_P1_D+	19	Power
10	NC	20	No Pin

### 16) CASE\_OPEN (Case Open Intrusion Alert Header)

This motherboard provides a chassis detection feature that detects if the chassis cover has been removed. This function requires a chassis with chassis intrusion detection design.

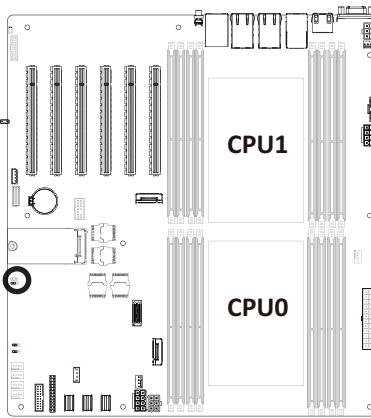

- Open: Normal Operation (Default)
- Closed: Active Chassis Intrusion Alert



### 17) LED\_BMC (BMC Firmware Readiness LED)

This motherboard provides a chassis detection feature that detects if the chassis cover has been removed. This function requires a chassis with chassis intrusion detection design.

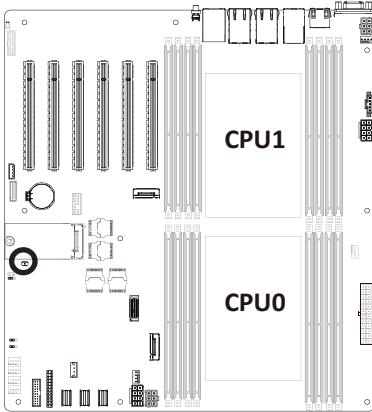

State	Description
On	BMC firmware is initial
Blink	BMC firmware is ready
Off	AC loss

### 19) BP\_1 (HDD Backplane Board Connector)

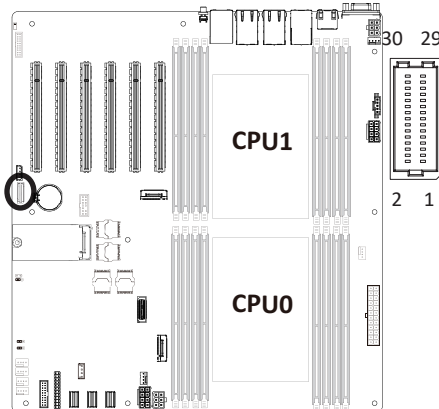

Pin No.	Definition	Pin No.	Definition
1	HP_ALERT_L	2	BPMI DIN/OUT
3	GND	4	BPMI DOUT/IN
5	BPMI_LOAD	6	GND
7	BPMI_CLK	8	PLD_Program_EN
9	GLED_AMB_N	10	GLED_GRN_N
11	FAN_IRQ_N	12	Reserved
13	BP_SCL	14	GND
15	BP_SDA	16	BP_RST_N
17	SMB_U2_TMP_SCL	18	GND
19	SMB_U2_TMP_SDA	20	I2C_DEV_RST
21	PH_HP_SCL0	22	GND
23	PH_HP_SDA0	24	GND
25	PH_HP_SCL1	26	GND
27	PH_HP_SDA1	28	GND
29	P3V3_AUX	30	P3V3_AUX

## 20) BAT (Battery Socket)

The battery provides power to keep the values (such as BIOS configurations, date, and time information) in the CMOS when the computer is turned off. Replace the battery when the battery voltage drops to a low level, or the CMOS values may not be accurate or may be lost.

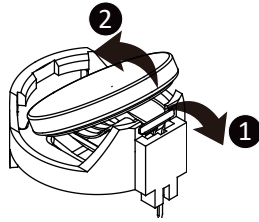
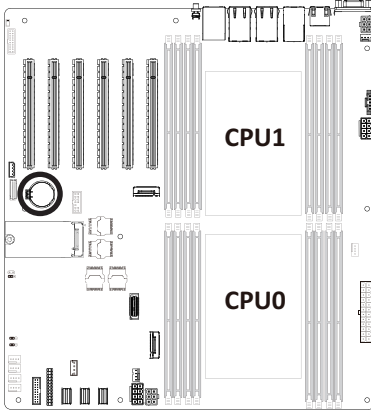

- Always turn off your computer and unplug the power cord before replacing the battery.
- Replace the battery with an equivalent one. Danger of explosion if the battery is replaced with an incorrect model.
- Contact the place of purchase or local dealer if you are not able to replace the battery by yourself or uncertain about the battery model.
- Used batteries must be handled in accordance with local environmental regulations.

## 21) TPM (Trusted Platform Module Connector)

Trusted Platform Module (TPM) is an international standard for a secure cryptoprocessor, a dedicated microcontroller designed to secure hardware through integrated cryptographic keys.

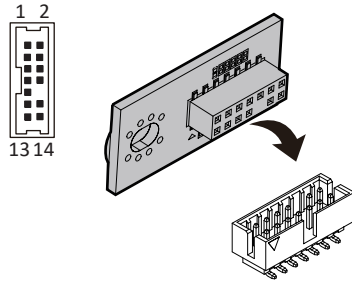
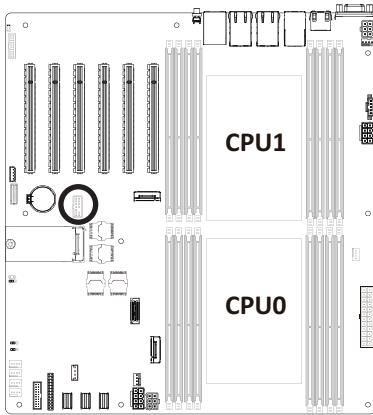

Pin No.	Definition	Pin No.	Definition
1	Clock	8	No Connect
2	P_3V3_AUX	9	No Connect
3	LPC_RST	10	No Pin
4	No Connect	11	No Connect
5	SPI_MISO	12	GND
6	IRQ_SPI	13	SPI_CS_N
7	SPI_MOSI	14	GND

## 23) IPMB (IPMB Connector)

The IPMB connector is used to connect Intelligent Platform Management Bus (IPMB) devices in a computer system for remote monitoring and management capabilities..

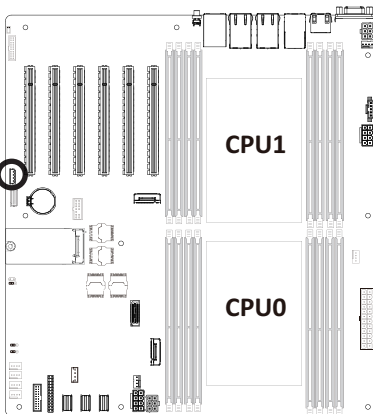

Pin No.	Definition
1	Clock
2	GND
3	Data
4	VCC

### 30) CN\_NCSI (NCSI Connector)

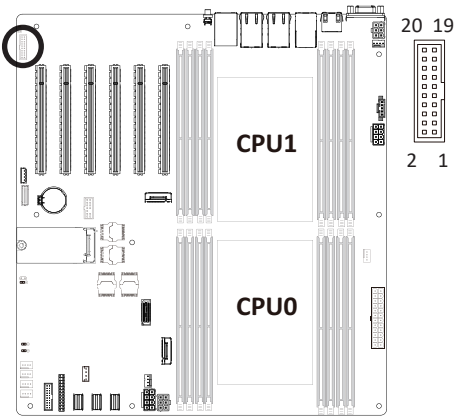

Pin No.	Definition	Pin No.	Definition
1	NCSI_CLK	2	GND
3	NCSI_RX_D0	4	GND
5	NCSI_RX_D1	6	GND
7	NCSI_CRD_V	8	GND
9	NCSI_RX_ER	10	GND
11	P3V3_AUX	12	GND
13	NCSI_TX_D1	14	GND
15	NCSI_TX_D0	16	GND
17	NCSI_TX_EN	18	GND
19	NCSI_PRESENT	20	P3V3_AUX

# 1-8 Jumper Settings

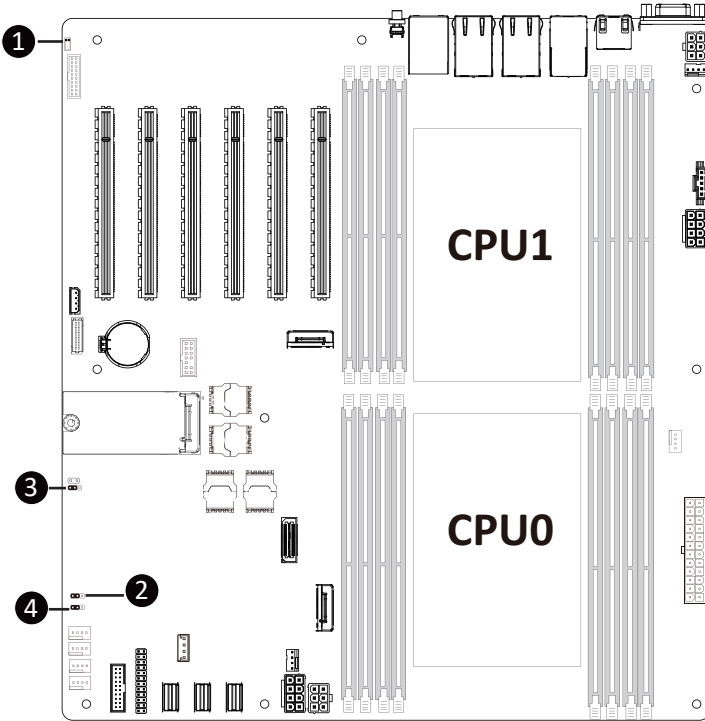

No.	Jumper Name	Jumper Setting		
1	NCSI_SW	SW1	SW2	
		OFF	ON	Onboard 10GbE LAN
		OFF	OFF	Onboard 1GbE LAN
		ON	-	CN_NCSI
2	BIOS Recovery (BIOS_RCVR)	1-2: Enable 2-3: Default		
3	Clear CMOS (CLR_CMOS)	1-2: Nomal operation (Default) 2-3: Clear CMOS data (Enable)		
4	Password Clear (BIOS_PWD)	1-2: Default 2-3: Enable		

## Chapter 5 BIOS Setup

BIOS (Basic Input and Output System) records hardware parameters of the system in the EFI on the motherboard. Its major functions include conducting the Power-On Self-Test (POST) during system startup, saving system parameters, loading the operating system etc. The BIOS includes a BIOS Setup program that allows the user to modify basic system configuration settings or to activate certain system features. When the power is turned off, the battery on the motherboard supplies the necessary power to the CMOS to keep the configuration values in the CMOS.

To access the BIOS Setup program, press the <DEL> key during the POST when the power is turned on.



- BIOS flashing is potentially risky, if you do not encounter any problems when using the current BIOS version, it is recommended that you don't flash the BIOS. To flash the BIOS, do it with caution. Inadequate BIOS flashing may result in system malfunction.
- It is recommended that you not alter the default settings (unless you need to) to prevent system instability or other unexpected results. Inadequately altering the settings may result in system's failure to boot. If this occurs, try to clear the CMOS values and reset the board to default values. (Refer to the **Exit** section in this chapter or introductions of the battery/clearing CMOS jumper in Chapter 4 for how to clear the CMOS values.)

### BIOS Setup Program Function Keys

<<-><->>	Move the selection bar to select the screen
<↑><↓>	Move the selection bar to select an item
<+>	Increase the numeric value or make changes
<->	Decrease the numeric value or make changes
<Enter>	Execute command or enter the submenu
<Esc>	Main Menu: Exit the BIOS Setup program Submenus: Exit current submenu
<F1>	Show descriptions of general help
<F3>	Restore the previous BIOS settings for the current submenus
<F9>	Load the Optimized BIOS default settings for the current submenus
<F10>	Save all the changes and exit the BIOS Setup program

■ **Main**

This setup page includes all the items of the standard compatible BIOS.

■ **Advanced**

This setup page includes all the items of AMI BIOS special enhanced features.

(ex: Auto detect fan and temperature status, automatically configure hard disk parameters.)

■ **Chipset**

This setup page includes all the submenu options for configuring the functions of the Platform Controller Hub.

■ **Server Management**

Server additional features enabled/disabled setup menus.

■ **Security**

Change, set, or disable supervisor and user password. Configuration supervisor password allows you to restrict access to the system and BIOS Setup.

A supervisor password allows you to make changes in BIOS Setup.

A user password only allows you to view the BIOS settings but not to make changes.

■ **Boot**

This setup page provides items for configuration of the boot sequence.

■ **Save & Exit**

Save all the changes made in the BIOS Setup program to the CMOS and exit BIOS Setup. (Pressing <F10> can also carry out this task.)

Abandon all changes and the previous settings remain in effect. Pressing <Y> to the confirmation message will exit BIOS Setup. (Pressing <Esc> can also carry out this task.)

# 5-1 The Main Menu

Once you enter the BIOS Setup program, the Main Menu (as shown below) appears on the screen. Use arrow keys to move among the items and press <Enter> to accept or enter other sub-menu.

## Main Menu Help

The on-screen description of a highlighted setup option is displayed on the bottom line of the Main Menu.

## Submenu Help

While in a submenu, press <F1> to display a help screen (General Help) of function keys available for the menu. Press <Esc> to exit the help screen. Help for each item is in the Item Help block on the right side of the submenu.



- When the system is not stable as usual, select the **Restore Defaults** item to set your system to its defaults.
- The BIOS Setup menus described in this chapter are for reference only and may differ by BIOS version.

Aptio Setup - AMI	
Main    Advanced    Chipset    Server Mgmt    Security    Boot    Save & Exit	
BIOS Information	
Project Name	M874-HB0-000
Project Version	F08
Build Date and Time	07/09/2024 22:01:15
BMC Information	
BMC Firmware Version	13.06.07
Processor Information	
CPU 0 Brand String	Intel(R) Xeon(R) 6710E
CPU 1 Brand String	Intel(R) Xeon(R) 6710E
Max CPU Speed	2400 MHZ
CPU Signature	A06F3
Processor Core	128
Microcode Patch	030001B3
Platform Information	
Processor	A06F3 - SRF-SP C0
RC Revision	003218.D03
Memory Information	
Total Memory	524288 MB
Usable Memory	524288 MB
Memory Frequency	5600 MHZ

Help Area:

- +/: Select Screen
- ↑↓: Select Item
- K/M: Scroll Help Area Up/Down.
- Enter: Select
- +/-: Change Opt.
- F1: General Help
- F3: Previous Values
- F9: Optimized Defaults
- F10: Save & Exit
- ESC: Exit

Version 2.22.1294 Copyright (C) 2024 AMI



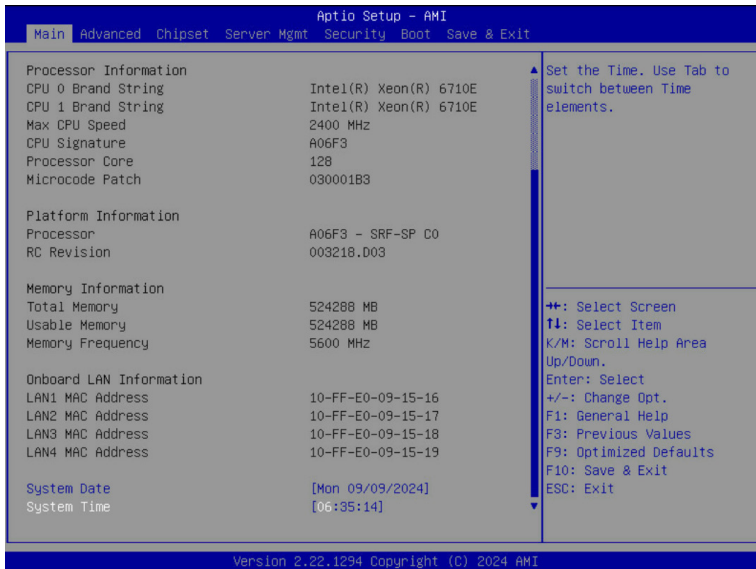

Parameter	Description
<b>BIOS Information</b>	
Project Name	Displays the project name information.
Project Version	Displays version number of the BIOS setup utility.
Build Date and Time	Displays the date and time when the BIOS setup utility was created.
<b>BMC Information<sup>(Note1)</sup></b>	
BMC Firmware Version <sup>(Note1)</sup>	Displays BMC firmware version information.
<b>Processor Information</b>	
CPU Brand String/ Max CPU Speed / CPU Signature / Processor Core / Microcode Patch	Displays the technical information for the installed processor(s).
<b>Platform Information</b>	
Processor/ PCH/ RC Revision	Displays the information of the installed processor(s) and PCH.
<b>Memory Information<sup>(Note2)</sup></b>	
Total Memory	Displays the total memory size of the installed memory.
Usable Memory	Displays the usable memory size of the installed memory.

(Note1) Functions available on selected models.

(Note2) This section will display capacity and frequency information of the memory that the customer has installed.

<b>Parameter</b>	<b>Description</b>
Memory Frequency	Displays the frequency information of the installed memory.
System Date	Sets the date following the weekday-month-day-year format.
System Time	Sets the system time following the hour-minute-second format.

## 5-2 Advanced Menu

The Advanced Menu displays submenu options for configuring the function of various hardware components. Select a submenu item, then press <Enter> to access the related submenu screen.

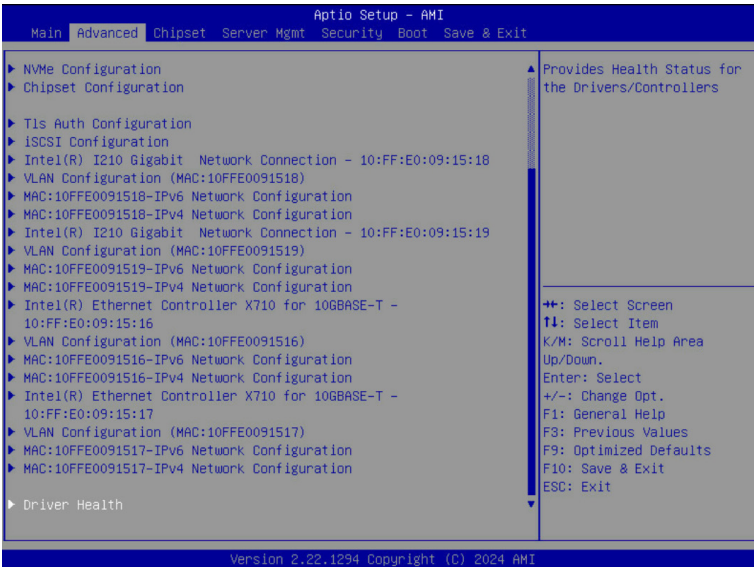
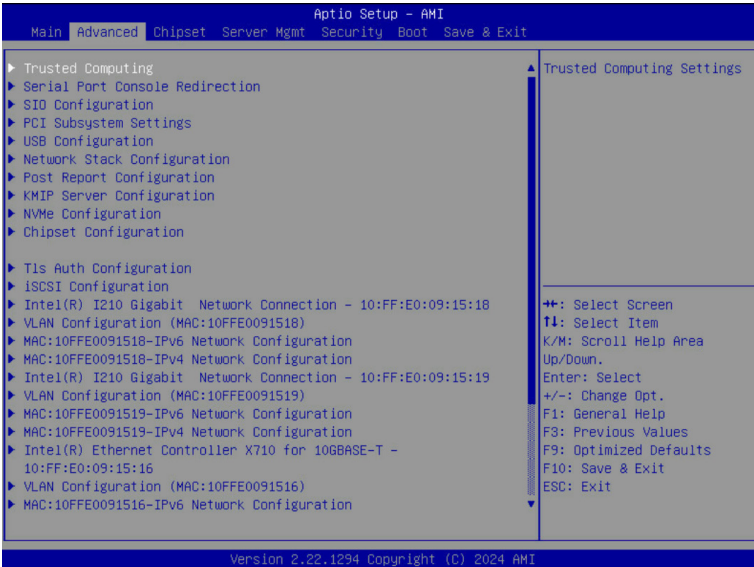

## 5-2-1 Trusted Computing



Parameter	Description
Configuration	
TPM v1.2 Support	<p>Enable/Disable BIOS support for security device. OS will not show security device. TCG EFI protocol and INT1A interface will not be available.</p> <p>Options available: Disable, Enable. Default setting is <b>Enable</b>.</p>

## 5-2-2 Serial Port Console Redirection

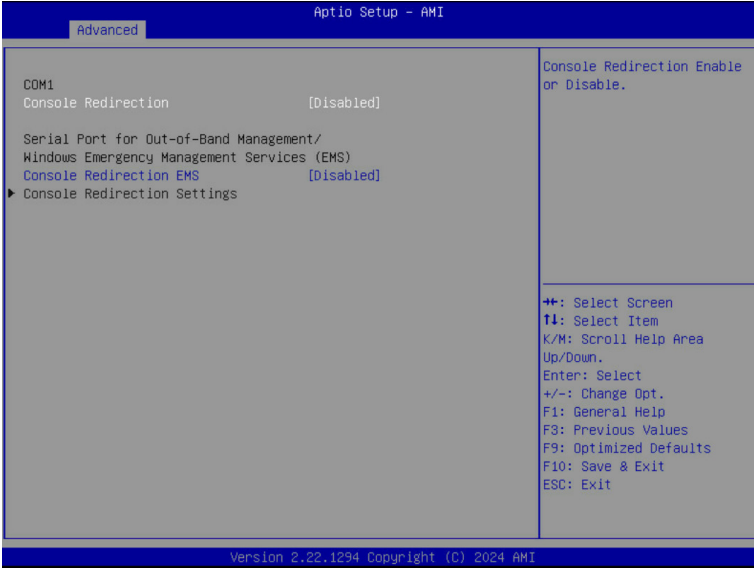

Parameter	Description
COM1 Console Redirection <sup>(Note)</sup>	<p>Console redirection enables the users to manage the system from a remote location.</p> <p>Options available: Enabled, Disabled. Default setting is <b>Disabled</b>.</p>
COM1 Console Redirection Settings	<p>Press [Enter] to configure advanced items.</p> <p><b>Please note that this item is configurable when COM1 Console Redirection is set to Enabled.</b></p> <ul style="list-style-type: none"> <li>◆ Terminal Type <ul style="list-style-type: none"> <li>– Selects a terminal type to be used for console redirection.</li> <li>– Options available: VT100, VT100PLUS, VT-UTF8, ANSI. Default setting is <b>VT100PLUS</b>.</li> </ul> </li> <li>◆ Bits per second <ul style="list-style-type: none"> <li>– Selects the transfer rate for console redirection.</li> <li>– Options available: 9600, 19200, 38400, 57600, 115200. Default setting is <b>115200</b>.</li> </ul> </li> <li>◆ Data Bits <ul style="list-style-type: none"> <li>– Selects the number of data bits used for console redirection.</li> <li>– Options available: 7, 8. Default setting is <b>8</b>.</li> </ul> </li> </ul>

(Note) Advanced items prompt when this item is defined.

Parameter	Description
COM1 Console Redirection Settings (continued)	<ul style="list-style-type: none"> <li>◆ Parity <ul style="list-style-type: none"> <li>– A parity bit can be sent with the data bits to detect some transmission errors.</li> <li>– Even: parity bit is 0 if the num of 1's in the data bits is even.</li> <li>– Odd: parity bit is 0 if num of 1's in the data bits is odd.</li> <li>– Mark: parity bit is always 1. Space: Parity bit is always 0.</li> <li>– Mark and Space Parity do not allow for error detection.</li> <li>– Options available: None, Even, Odd, Mark, Space. Default setting is <b>None</b>.</li> </ul> </li> <li>◆ Stop Bits <ul style="list-style-type: none"> <li>– Stop bits indicate the end of a serial data packet. (A start bit indicates the beginning). The standard setting is 1 stop bit. Communication with slow devices may require more than 1 stop bit.</li> <li>– Options available: 1, 2. Default setting is <b>1</b>.</li> </ul> </li> <li>◆ Flow Control <ul style="list-style-type: none"> <li>– Flow control can prevent data loss from buffer overflow. When sending data, if the receiving buffers are full, a 'stop' signal can be sent to stop the data flow. Once the buffers are empty, a 'start' signal can be sent to re-start the flow. Hardware flow control uses two wires to send start/stop signals.</li> <li>– Options available: None, Hardware RTS/CTS. Default setting is <b>None</b>.</li> </ul> </li> <li>◆ VT-UTF8 Combo Key Support <ul style="list-style-type: none"> <li>– Enable/Disable the VT-UTF8 Combo Key Support.</li> <li>– Options available: Enabled, Disabled. Default setting is <b>Enabled</b>.</li> </ul> </li> <li>◆ Recorder Mode <ul style="list-style-type: none"> <li>– When this mode enabled, only texts will be send. This is to capture Terminal data.</li> <li>– Options available: Enabled, Disabled. Default setting is <b>Disabled</b>.</li> </ul> </li> <li>◆ Resolution 100x31 <ul style="list-style-type: none"> <li>– Enable/Disable extended terminal resolution.</li> <li>– Options available: Enabled, Disabled. Default setting is <b>Enabled</b>.</li> </ul> </li> <li>◆ Putty Keypad <ul style="list-style-type: none"> <li>– Selects Function Key and Keypad on Putty.</li> <li>– Options available: VT100, LINUX, XTERMR6, SC0, ESCN, VT400. Default setting is <b>VT100</b>.</li> </ul> </li> </ul>

Parameter	Description
Serial Port for Out-of-Band Management / Windows Emergency Management Services (EMS) Console Redirection <sup>(Note)</sup>	<p>EMS console redirection allows the user to configure Console Redirection Settings to support Out-of-Band Serial Port management.</p> <p>Options available: Enabled, Disabled. Default setting is <b>Disabled</b>.</p>
Serial Port for Out-of-Band EMS Console Redirection Settings	<p>Press [Enter] to configure advanced items.</p> <p><b>Please note that this item is configurable when Serial Port for Out-of-Band Management EMS Console Redirection is set to Enabled.</b></p> <ul style="list-style-type: none"> <li>◆ Out-of-Band Mgmt Port <ul style="list-style-type: none"> <li>– Microsoft Windows Emergency Management Service (EMS) allows for remote management of a Windows Server OS through a serial port.</li> <li>– Default setting is <b>COM1</b>.</li> </ul> </li> <li>◆ Terminal Type EMS <ul style="list-style-type: none"> <li>– Selects a terminal type to be used for console redirection.</li> <li>– Options available: VT100, VT100PLUS, VT-UTF8, ANSI. Default setting is <b>VT100PLUS</b>.</li> </ul> </li> <li>◆ Bits per second EMS <ul style="list-style-type: none"> <li>– Selects the transfer rate for console redirection.</li> <li>– Options available: 9600, 19200, 57600, 115200. Default setting is <b>115200</b>.</li> </ul> </li> <li>◆ Flow Control EMS <ul style="list-style-type: none"> <li>– Flow control can prevent data loss from buffer overflow. When sending data, if the receiving buffers are full, a 'stop' signal can be sent to stop the data flow. Once the buffers are empty, a 'start' signal can be sent to re-start the flow. Hardware flow control uses two wires to send start/stop signals.</li> <li>– Options available: None, Hardware RTS/CTS, Software Xon/Xoff. Default setting is <b>None</b>.</li> </ul> </li> </ul>

### 5-2-3 SIO Configuration

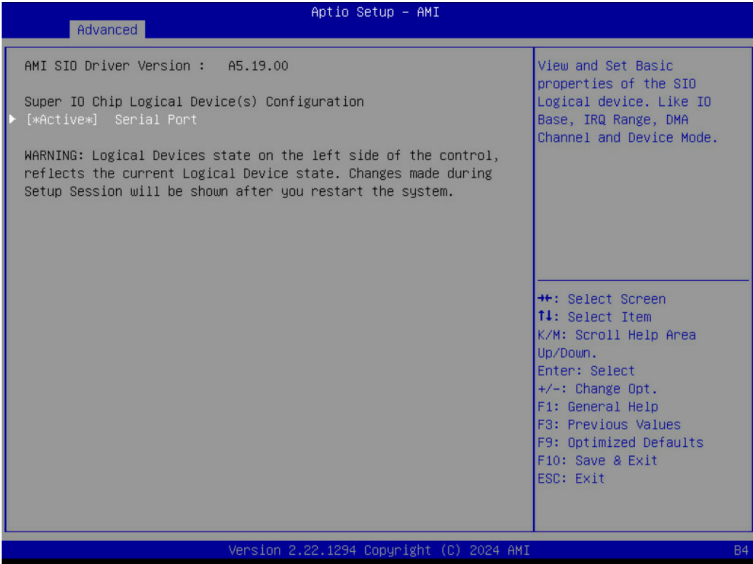

Parameter	Description
AMI SIO Driver Version	Displays the AMI SIO driver version information.
Super IO Chip Logical Device(s) Configuration	Press [Enter] to configure advanced items. <ul style="list-style-type: none"> <li>◆ Use This Device <ul style="list-style-type: none"> <li>– When set to Enabled allows you to configure the serial port settings. When set to Disabled, displays no configuration for the serial port.</li> <li>– Options available: Enabled, Disabled. Default setting is <b>Enabled</b>.</li> </ul> </li> <li>◆ Logical Device Settings/Current: <ul style="list-style-type: none"> <li>– Displays the serial port base I/O address and IRQ.</li> </ul> </li> <li>◆ Possible: <ul style="list-style-type: none"> <li>– Configures the serial port base I/O address and IRQ. <ul style="list-style-type: none"> <li>Use Automatic Settings</li> <li>IO=3F8h; IRQ=4; DMA;</li> <li>IO=3F8h; IRQ=4; DMA;</li> <li>IO=2F8h; IRQ=4; DMA;</li> <li>IO=3E8h; IRQ=4; DMA;</li> <li>IO=2E8h; IRQ=4; DMA;</li> </ul> </li> </ul> </li> </ul>
[*Active*] Serial Port	Default setting is <b>Use Automatic Settings</b> .



## 5-2-4 PCI Subsystem Settings

Aptio Setup - AMI

Advanced

PCI Bus Driver Version	A5.01.32	▲ Enable/Disable PCIe_1 I/O ROM ▼
PCIe_1 I/O ROM	[Enabled]	
PCIe_1 Lanes	[Auto]	
PCIe_1 Max Link Speed	[Auto]	
PCIe_2 I/O ROM	[Enabled]	
PCIe_2 Lanes	[Auto]	
PCIe_2 Max Link Speed	[Auto]	
PCIe_3 I/O ROM	[Enabled]	
PCIe_3 Lanes	[Auto]	
PCIe_3 Max Link Speed	[Auto]	
PCIe_4 I/O ROM	[Enabled]	
PCIe_4 Lanes	[Auto]	
PCIe_4 Max Link Speed	[Auto]	
PCIe_5 I/O ROM	[Enabled]	▲ ⇧: Select Screen ⇩: Select Item K/M: Scroll Help Area Up/Down. Enter: Select +/-: Change Opt. F1: General Help F3: Previous Values F9: Optimized Defaults F10: Save & Exit ESC: Exit
PCIe_5 Lanes	[Auto]	
PCIe_5 Max Link Speed	[Auto]	
PCIe_6 I/O ROM	[Enabled]	
PCIe_6 Lanes	[Auto]	
PCIe_6 Max Link Speed	[Auto]	

Version 2.22.1294 Copyright (C) 2024 AMI

Aptio Setup - AMI

Advanced

PCIe_6 I/O ROM	[Enabled]	▲ If system has SR-IOV capable PCIe Devices, this option Enables or Disables Single Root IO Virtualization Support. ▼
PCIe_6 Lanes	[Auto]	
PCIe_6 Max Link Speed	[Auto]	
M2_0 I/O ROM	[Enabled]	
M2_0 Lanes	[Auto]	
M2_0 Max Link Speed	[Auto]	
M2_1 I/O ROM	[Enabled]	
M2_1 Lanes	[Auto]	
M2_1 Max Link Speed	[Auto]	
Onboard LAN3 Controller	[Enabled]	
Onboard LAN4 Controller	[Enabled]	
Onboard LAN1 I/O ROM	[Enabled]	
Onboard LAN2 I/O ROM	[Enabled]	
Onboard LAN3 I/O ROM	[Enabled]	
Onboard LAN4 I/O ROM	[Enabled]	
PCI Devices Common Settings:		▲ ⇧: Select Screen ⇩: Select Item K/M: Scroll Help Area Up/Down. Enter: Select +/-: Change Opt. F1: General Help F3: Previous Values F9: Optimized Defaults F10: Save & Exit ESC: Exit
Re-Size BAR Support	[Disabled]	
SR-IOV Support	[Enabled]	

Version 2.22.1294 Copyright (C) 2024 AMI

Parameter	Description
PCI Bus Driver Version	Displays the PCI Bus Driver version information.
SLOT# I/O ROM <sup>(Note1)</sup>	When enabled, this setting will initialize the device expansion ROM for the related PCI-E slot. Options available: Enabled, Disabled. Default setting is <b>Enabled</b> .
SLOT# Lanes <sup>(Note1)</sup>	Change the PCIe lanes. Default setting is <b>Auto</b> .
SLOT# Max Link Speed <sup>(Note1)</sup>	Configure PCIe max link speed. Options available: Auto, Gen1, Gen2, Gen3, Gen4, Gen5. Default setting is <b>Auto</b> .
M2M I/O ROM <sup>(Note2)</sup>	Enable/Disable M2M devices, and initializes device expansion ROM. Options available: Enabled, Disabled. Default setting is <b>Enabled</b> .
M2M Lanes <sup>(Note2)</sup>	Change the M2M PCIe lanes. Options available: Auto, x4, x2x2. Default setting is <b>Auto</b> .
M2M Max Link Speed <sup>(Note2)</sup>	Configure M2M max link speed. Options available: Auto, Gen1, Gen2, Gen3, Gen4, Gen5. Default setting is <b>Auto</b> .
PCI Devices Common Settings	
Above 4G Decoding	Enable/Disable memory mapped I/O to 4GB or greater address space (Above 4G Decoding). Options available: Enabled, Disabled. Default setting is <b>Enabled</b> .
SR-IOV Support	If the system has SR-IOV capable PCIe devices, this item Enable/Disable Single Root IO Virtualization Support. Options available: Enabled, Disabled. Default setting is <b>Enabled</b> .

(Note1) This section is dependent on the available PCIe Slot.

(Note2) This section is dependent on the available M.2 Slot.

## 5-2-5 USB Configuration

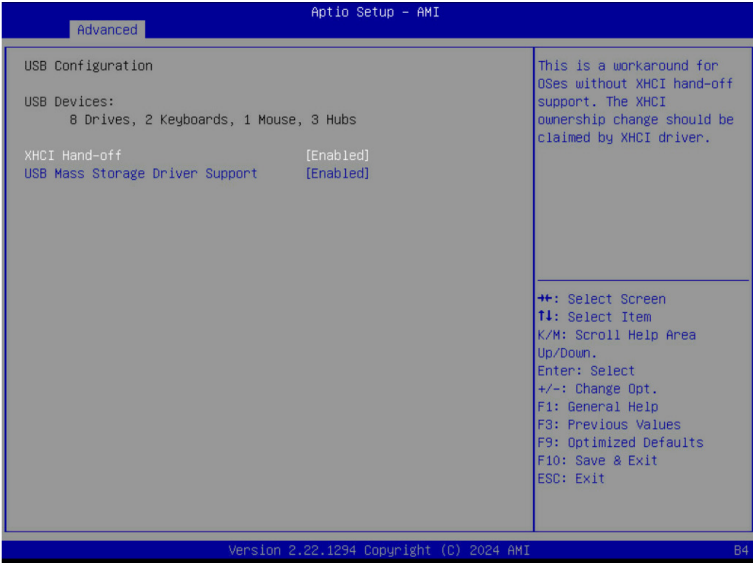

Parameter	Description
USB Configuration	
USB Devices:	Displays the USB devices connected to the system.
XHCI Hand-off	Enable/Disable the XHCI (USB 3.0) Hand-off support. Options available: Enabled, Disabled. Default setting is <b>Enabled</b> .
USB Mass Storage Driver Support <sup>(Note)</sup>	Enable/Disable the USB Mass Storage Driver Support. Options available: Enabled, Disabled. Default setting is <b>Enabled</b> .
Port 60/64 Emulation	Enables the I/O port 60h/64h emulation support. This should be enabled for the complete USB Keyboard Legacy support for non-USB aware OSes. Options available: Enabled, Disabled. Default setting is <b>Enabled</b> .

(Note) This item is present only if you attach USB devices.

## 5-2-6 Network Stack Configuration

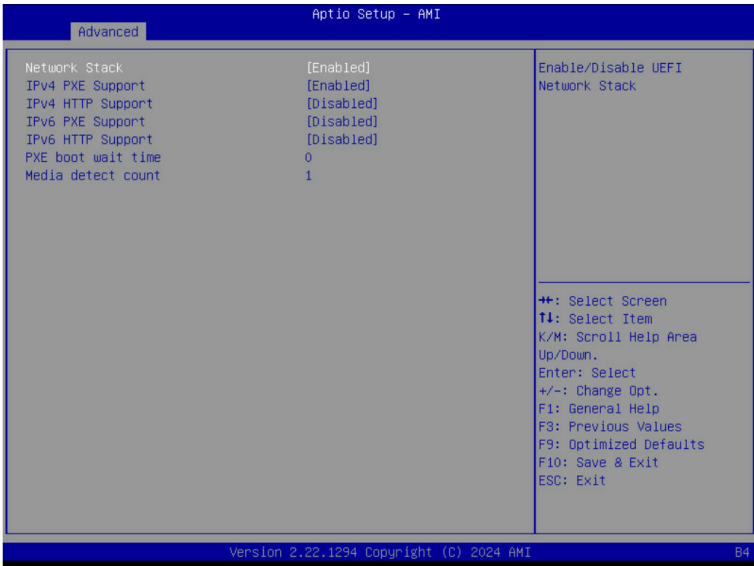

Parameter	Description
Network Stack	Enable/Disable the UEFI network stack. Options available: Enabled, Disabled. Default setting is <b>Enabled</b> .
IPv4 PXE Support	Enable/Disable the IPv4 PXE feature. Options available: Enabled, Disabled. Default setting is <b>Enabled</b> .
IPv4 HTTP Support	Enable/Disable the IPv4 HTTP feature. Options available: Enabled, Disabled. Default setting is <b>Disabled</b> .
IPv6 PXE Support	Enable/Disable the IPv6 PXE feature. Options available: Enabled, Disabled. Default setting is <b>Disabled</b> .
IPv6 HTTP Support	Enable/Disable the IPv6 HTTP feature. Options available: Enabled, Disabled. Default setting is <b>Disabled</b> .
PXE boot wait time	Wait time in seconds to press ESC key to abort the PXE boot. Press the <+> / <-> keys to increase or decrease the desired values.
Media detect count	Number of times the presence of media will be checked. Press the <+> / <-> keys to increase or decrease the desired values.

## 5-2-7 Post Report Configuration

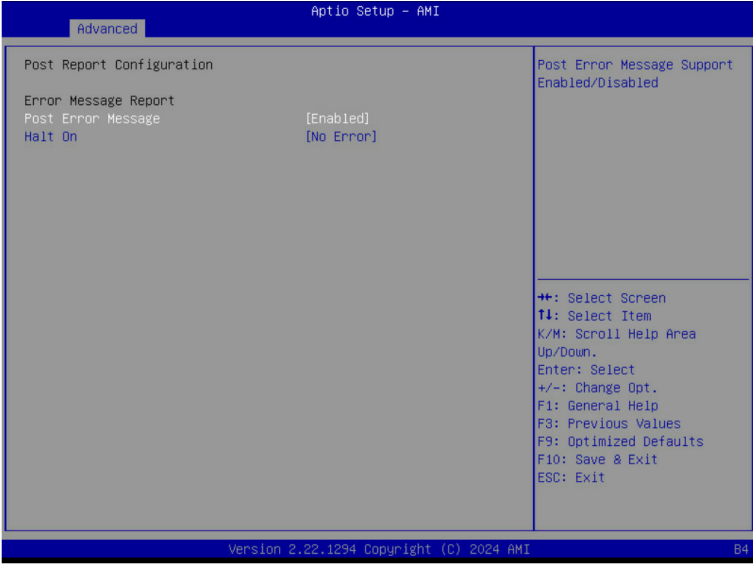

Parameter	Description
Post Report Configuration	
Error Message Report	
Post Error Message	Enable/Disable the POST Error Message support. Options available: Enabled, Disabled. Default setting is <b>Enabled</b> .
Halt On	Options available: No Error, All Error. Default setting is <b>No Error</b> .

## 5-2-8 KMIP Server Configuration

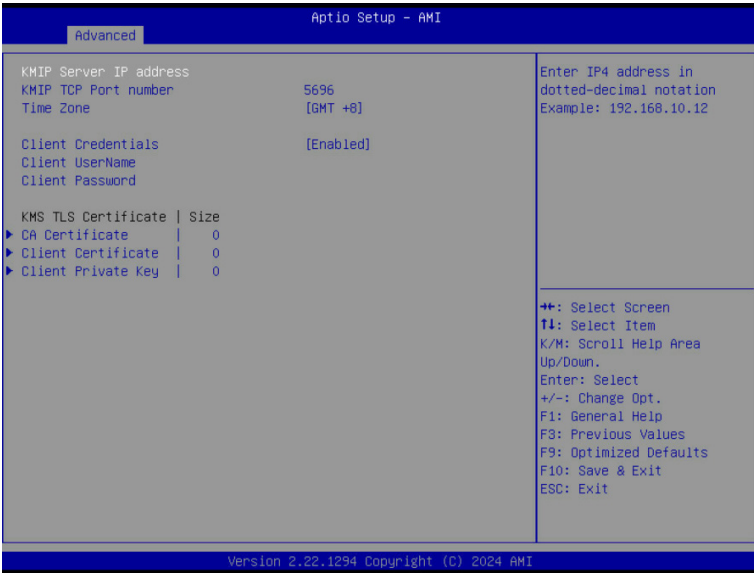

Parameter	Description
KMIP Server IP address	
KMIP TCP Port Number	
Time Zone	Enter the correct timem zone for this server. Default setting is <b>GMT+8</b> .
Client Credentials	Use User and password credentials to authenticate the Client. Options available: Enabled, Disabled, Clear. Default setting is <b>Enabled</b> .
Client UserName	Enter Client identify: UserName. Name Length: 0-63 characters.
Client Password	Enter Client identify: Password. Password Length: 0-31 characters.
KMS TLC Certificate / Size	
CA Certificate	Enroll factory defaults or load the KMS TLS certificates from the file.
Client Certificate	Enroll factory defaults or load the KMS TLS certificates from the file.
Client Private Key	Enroll factory defaults or load the KMS TLS certificates from the file.

## 5-2-9 NVMe Configuration

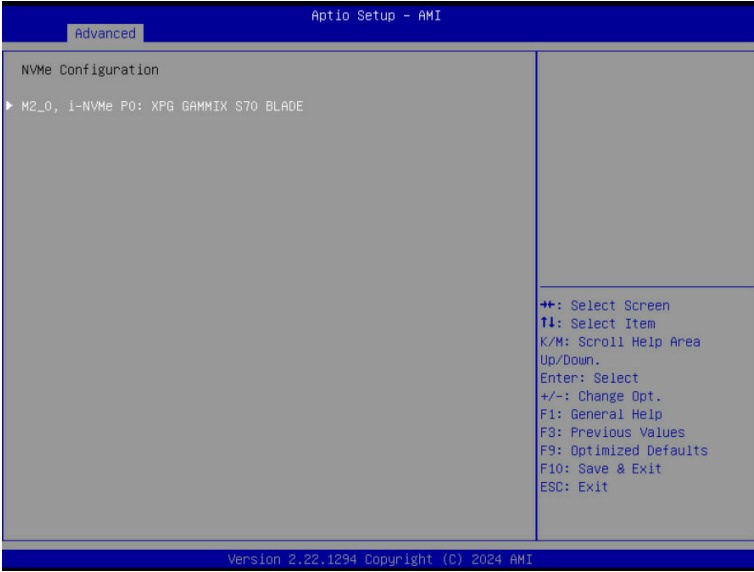

Parameter	Description
NVMe Configuration	Displays the NVMe devices connected to the system.



## 5-2-10 Chipset Configuration

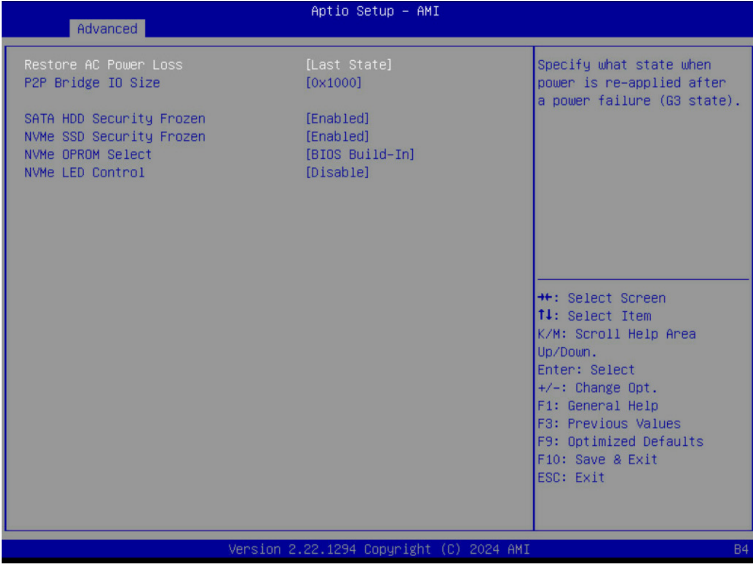

Parameter	Description
Restore on AC Power Loss <sup>(Note)</sup>	Defines the power state to resume to after a system shutdown that is due to an interruption in AC power. When set to Last State, the system will return to the active power state prior to shutdown. When set to Power Off, the system remains off after power shutdown. Options available: Last State, Power Off, Power On, Unspecified. The default setting depends on the BMC setting.
P2P Bridge IO Size	Specifies P2P Bridge IO aligned to the size. Options available: 0x100, 0x150, 0x1000. Default setting is <b>0x1000</b> .
SATA HDD Security Frozen	Enable/Disable this item to send freeze lock command to SATA HDD. Options available: Enabled, Disabled. Default setting is <b>Enabled</b> .
NVMe SSD Security Frozen	Attempt to send freeze lock command to NVMe SSDs during boot. Options available: Enabled, Disabled. Default setting is <b>Enabled</b> .
NVMe OPROM Select	Options available: BIOS Build-In, NVMe Device, Disabled. Default setting is <b>BIOS Build-In</b> .
NVMe LED Control	Enable/Disable allow user control NVMe LED. It only available the NVMe device direct connect to CPU. Options available: Disable, Enable. Default setting is <b>Disable</b> .

(Note) When the power policy is controlled by BMC, please wait for 15-20 seconds for BMC to save the last power state.

Parameter	Description
Chassis Opened Warning	Enable/Disable the chassis intrusion alert function. Options available: Enabled, Disabled, Clear. Default setting is <b>Disabled</b> .

## 5-2-11 Tls Auth Configuration

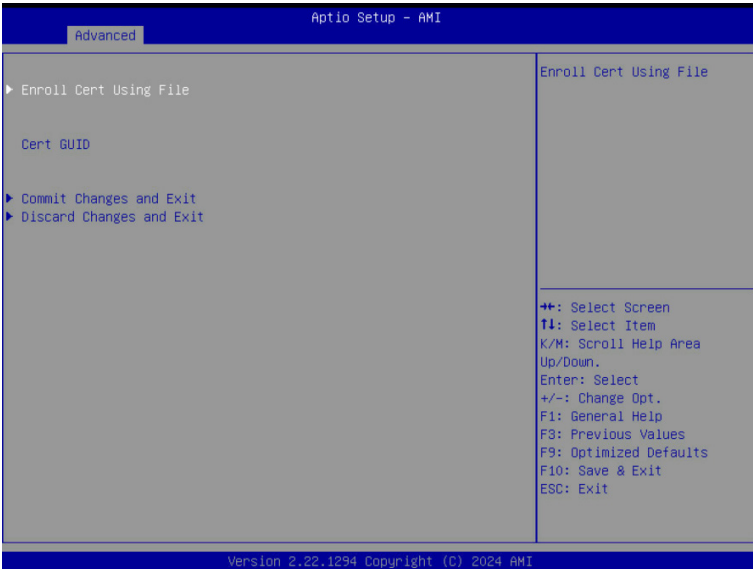
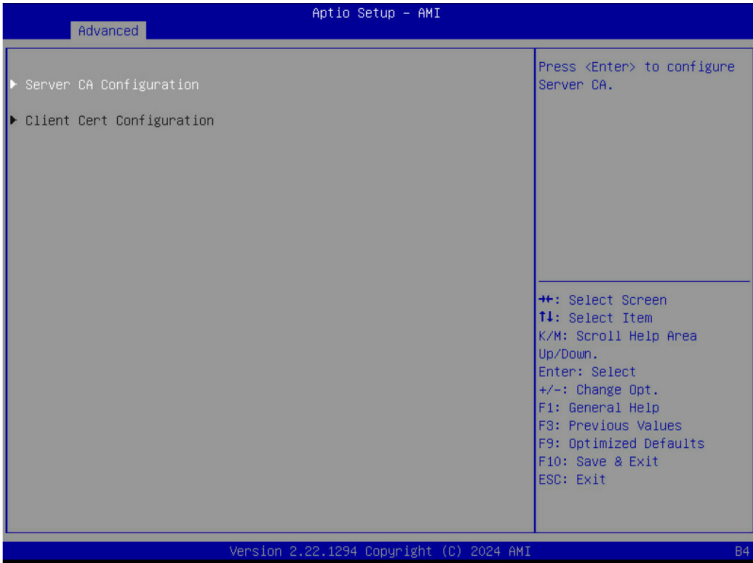

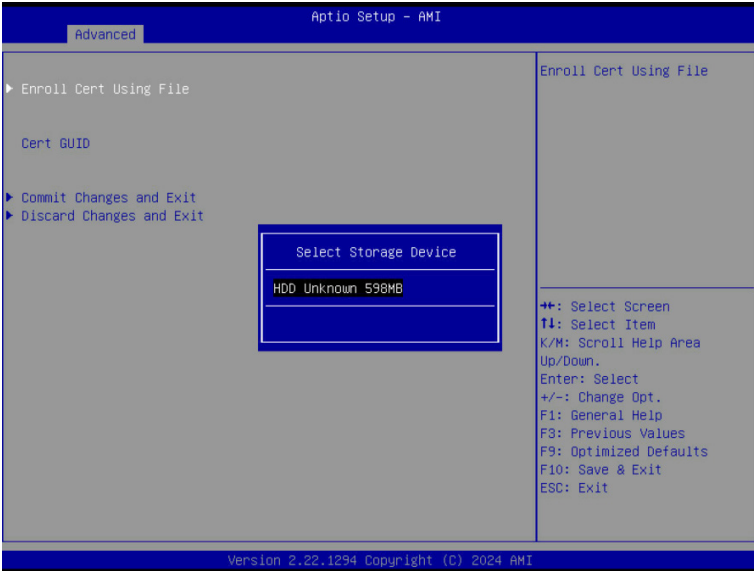

Parameter	Description
Server CA Configuration	<p>Press [Enter] for configuration of advanced items.</p> <ul style="list-style-type: none"><li>◆ Enroll Cert<ul style="list-style-type: none"><li>– Press [Enter] to enroll a certificate<ul style="list-style-type: none"><li>• Enroll Cert Using File</li><li>• Cert GUID</li></ul></li><li>Input digit character in 1111111-2222-3333-4444-1234567890ab format.</li><li>– Commit Changes and Exit</li><li>– Discard Changes and Exit</li></ul></li><li>◆ Delete Cert</li></ul>
Client Cert Configuration	<p>Press [Enter] for configuration of advanced items.</p>

## 5-2-12 iSCSI Configuration

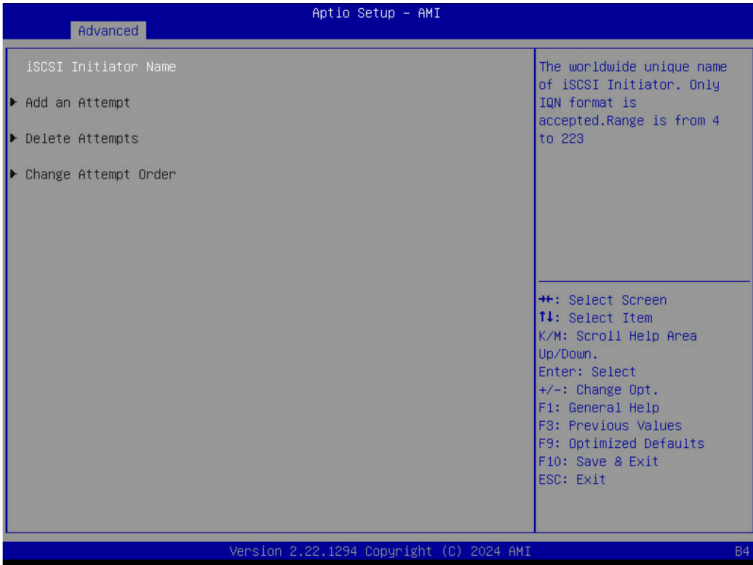

Parameter	Description
Attempt Priority	<p>Press [Enter] configure advanced items.</p> <ul style="list-style-type: none"> <li>◆ Attempt Priority                             <ul style="list-style-type: none"> <li>– Use arrow keys to select the attempt, then press +/- keys to move the attempt up/down in the attempt order list.</li> </ul> </li> <li>◆ Commit Changes and Exit</li> </ul>
Host iSCSI Configuration	<p>Press [Enter] to configure advanced items.</p> <ul style="list-style-type: none"> <li>◆ iSCSI Initiator Name                             <ul style="list-style-type: none"> <li>– Only IQN format is accepted. Range: from 4 to 223</li> </ul> </li> <li>◆ Add an Attempt</li> <li>◆ Delete Attempts</li> <li>◆ Change Attempt Order</li> </ul>

## 5-2-13 Intel(R) I210 Gigabit Network Connection

Advanced		Aptio Setup - AMI	
<p>▶ NIC Configuration</p> <p>Blink LEDs 0</p> <p>UEFI Driver Intel(R) PRO/1000 8.5.21 PCI-E</p> <p>Adapter PBA 140724-006</p> <p>Device Name Intel(R) I210 Gigabit Network Connection</p> <p>Chip Type Intel i210</p> <p>PCI Device ID 1533</p> <p>PCI Address 5F:00:00</p> <p>Link Status [Connected]</p> <p>MAC Address 10:FF:E0:09:15:18</p> <p>Virtual MAC Address 00:00:00:00:00:00</p>		<p>Click to configure the network device port.</p> <hr/> <p>                     ++: Select Screen                      ↑↓: Select Item                      K/M: Scroll Help Area                      Up/Down.                      Enter: Select                      +/-: Change Opt.                      F1: General Help                      F3: Previous Values                      F9: Optimized Defaults                      F10: Save &amp; Exit                      ESC: Exit                 </p>	
Version 2.22.1294 Copyright (C) 2024 AMI			

Advanced		Aptio Setup - AMI	
<p>Link Speed [Auto Negotiated]</p> <p>Wake On LAN [Enabled]</p>		<p>Specifies the port speed used for the selected boot protocol.</p> <hr/> <p>                     ++: Select Screen                      ↑↓: Select Item                      K/M: Scroll Help Area                      Up/Down.                      Enter: Select                      +/-: Change Opt.                      F1: General Help                      F3: Previous Values                      F9: Optimized Defaults                      F10: Save &amp; Exit                      ESC: Exit                 </p>	
Version 2.22.1294 Copyright (C) 2024 AMI			

Parameter	Description
NIC Configuration	<p>Press [Enter] to configure advanced items.</p> <ul style="list-style-type: none"> <li>◆ Link Speed <ul style="list-style-type: none"> <li>– Default setting is <b>Auto Negotiated</b>.</li> </ul> </li> <li>◆ Wake On LAN <ul style="list-style-type: none"> <li>– Enables power on of the system via LAN. Note that configuring Wake on LAN in the operating system does not change the value of this setting, but does override the behavior of Wake on LAN in OS controlled power states.</li> <li>– Options available: Enabled, Disabled. Default setting is <b>Enabled</b>.</li> </ul> </li> <li>◆ LLDP Agent <ul style="list-style-type: none"> <li>– Enable/Disable firmware's LLDP Agent.</li> <li>– Options available: Enabled, Disabled. Default setting is <b>Enabled</b></li> </ul> </li> </ul>
Blink LEDs	Identifies the physical network port by blinking the associated LED. Press the numeric keys to adjust desired values (up to 15 seconds).
UEFI Driver	Displays the technical specifications for the Network Interface Controller.
Adapter PBA	Displays the technical specifications for the Network Interface Controller.
Device Name	Displays the technical specifications for the Network Interface Controller.
Chip Type	Displays the technical specifications for the Network Interface Controller.
PCI Device ID	Displays the technical specifications for the Network Interface Controller.
PCI Address	Displays the technical specifications for the Network Interface Controller.
Link Status	Displays the technical specifications for the Network Interface Controller.
MAC Address	Displays the technical specifications for the Network Interface Controller.
Virtual MAC Address	Displays the technical specifications for the Network Interface Controller.



## 5-2-14 VLAN Configuration

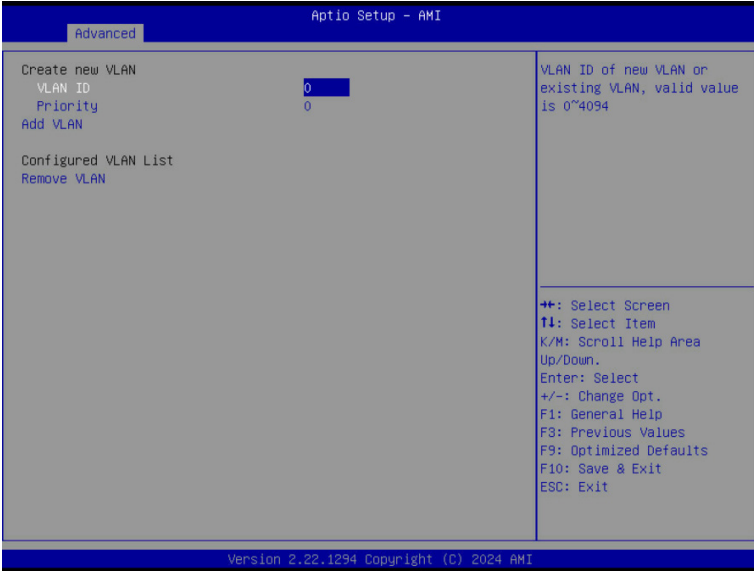

Parameter	Description
Enter Configuration Menu	<p>Press [Enter] to configure advanced items.</p> <ul style="list-style-type: none"> <li>◆ Create new VLAN</li> <li>◆ VLAN ID <ul style="list-style-type: none"> <li>– Sets VLAN ID for a new VLAN or an existing VLAN.</li> <li>– Press the &lt;+&gt; / &lt;-&gt; keys to increase or decrease the desired values.</li> <li>– The valid range is from 0 to 4094.</li> </ul> </li> <li>◆ Priority <ul style="list-style-type: none"> <li>– Sets 802.1Q Priority for a new VLAN or an existing VLAN.</li> <li>– Press the &lt;+&gt; / &lt;-&gt; keys to increase or decrease the desired values.</li> <li>– The valid range is from 0 to 7.</li> </ul> </li> <li>◆ Add VLAN <ul style="list-style-type: none"> <li>– Press [Enter] to create a new VLAN or update an existing VLAN.</li> </ul> </li> <li>◆ Configured VLAN List</li> <li>◆ Remove VLAN <ul style="list-style-type: none"> <li>– Press [Enter] to remove an existing VLAN.</li> </ul> </li> </ul>

### 5-3 Chipset Menu

Chipset Setup menu displays submenu options for configuring the function of Platform Controller Hub(PCH). Select a submenu item, then press <Enter> to access the related submenu screen.

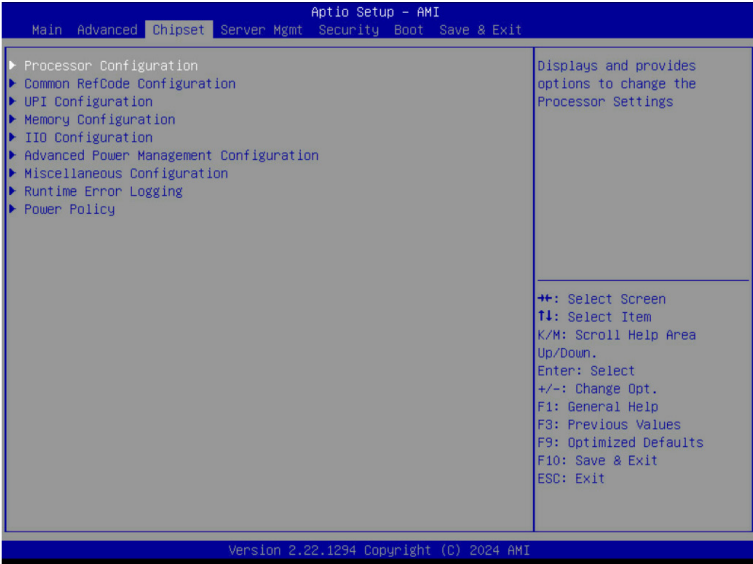

# 5-3-1 Processor Configuration

Aptio Setup - AMI

Chipset

Processor Configuration		Change Per-Socket Settings
-----		
▶ Per-Socket Configuration		
Processor Socket	Socket 0    Socket 1	
Processor ID	000A06F3*   000A06F3	
Processor Frequency	2.400GHz   2.400GHz	
Processor Max Ratio	18H   18H	
Processor Min Ratio	08H   08H	
Microcode Revision	030001B3   030001B3	
L1 Cache RAM(Per Core)	96KB   96KB	
L2 Cache RAM(Per Package)	65536KB   65536KB	
L3 Cache RAM(Per Package)	98304KB   98304KB	
Processor 0 Version	Intel(R) Xeon(R) 6710E	
Processor 1 Version	Intel(R) Xeon(R) 6710E	
-----		
Hardware Prefetcher	[Enable]	↕: Select Screen
Adjacent Cache Prefetch	[Enable]	↑: Select Item
DCU Streamer Prefetcher	[Disable]	K/M: Scroll Help Area
DCU IP Prefetcher	[Enable]	Up/Down.
L1 Next Page Prefetcher	[Disable]	Enter: Select
Enable Intel(R) TXT	[Disable]	+/-: Change Opt.
VMX	[Enable]	F1: General Help
Enable SMX	[Disable]	F3: Previous Values
		F9: Optimized Defaults
		F10: Save & Exit
		ESC: Exit

Version 2.22.1294 Copyright (C) 2024 AMI

Aptio Setup - AMI

Chipset

Processor Reserved Memory [Outputs]		Displays and provides option to change the Processor Dfx Settings
-----		
PRMRR Size per domain	16 MiB	
PRM Size per socket	16 MiB	
PRM Size per system	16 MiB	
-----		
Software Guard Extension (SGX) [Outputs]		
-----		
SGX activation state	Deactivated	
SGX error code [HEX]	16	
-----		
Software Guard Extension (SGX) [Inputs]		
-----		
SGX Factory Reset	[Disable]	↕: Select Screen
SW Guard Extensions (SGX)	[Disable]	↑: Select Item
SGX Package Info In-Band Access	[Disable]	K/M: Scroll Help Area
SGX PRMRR Size Requested	[Auto]	Up/Down.
-----		
In Field Scan (IFS)		Enter: Select
-----		
▶ In Field Scan (IFS)		+/-: Change Opt.
-----		
-----		
▶ Processor Dfx Configuration		F1: General Help
-----		
		F3: Previous Values
		F9: Optimized Defaults
		F10: Save & Exit
		ESC: Exit

Version 2.22.1294 Copyright (C) 2024 AMI

Parameter	Description
Processor Configuration	
Pre-Socket Configuration	<p>Press [Enter] to configure advanced items.</p> <ul style="list-style-type: none"> <li>◆ CPU Socket 0 Configuration <ul style="list-style-type: none"> <li>– Core Disable Bitmap(Hex) <ul style="list-style-type: none"> <li>• Number of Cores to enable. 0 means all cores. FFFFFFFF means to disable all cores. The maximum value depends on the number of CPUs available. Press the numeric keys to adjust desired values.</li> </ul> </li> </ul> </li> </ul>
Processor Socket / Processor ID / Processor Die Type / Processor Frequency / Processor Max Ratio / Processor Min Ratio / Microcode Revision / L1 Cache RAM(Per Core) / L2 Cache RAM(Per Core) / L3 Cache RAM(Per Package) / Processor # Version	Displays the technical specifications for the installed processor(s).
Enable LP [Global]	<p>Enables Logical processor (Software Method to Enable/Disable Logical Processor threads).</p> <p>Options available: ALL LPs, Single LP. Default setting is <b>ALL LPs</b>.</p>
Hardware Prefetcher	<p>Select whether to enable the speculative prefetch unit of the processor.</p> <p>Options available: Enable, Disable. Default setting is <b>Enable</b>.</p>
L2 RF0 Prefetch Disable	Options available: Enable, Disable. Default setting is <b>Disable</b> .
Adjacent Cache Prefetch	<p>When enabled, cache lines are fetched in pairs. When disabled, only the required cache line is fetched.</p> <p>Options available: Enable, Disable. Default setting is <b>Enable</b>.</p>
DCU Streamer Prefetcher	<p>Enable/Disable DCU streamer prefetcher.</p> <p>Options available: Enable, Disable. Default setting is <b>Enable</b>.</p>
DCU IP Prefetcher	<p>Enable/Disable DCU IP Prefetcher.</p> <p>Options available: Enable, Disable. Default setting is <b>Enable</b>.</p>
Extended APIC	<p>Enable/Disable extended APIC support. Note: The VT-d will be enabled automatically when x2APIC is enabled.</p> <p>Options available: Enable, Disable. Default setting is <b>Enable</b>.</p>
Enable Intel(R) TXT	<p>Enable/Disable the Intel Trusted Execution Technology support function.</p> <p>Options available: Enable, Disable. Default setting is <b>Disable</b>.</p>
VMX	<p>Enable/Disable the Vanderpool Technology. This will take effect after rebooting the system.</p> <p>Options available: Enable, Disable. Default setting is <b>Enable</b>.</p>
Enable SMX	<p>Enable/Disable the Safer Mode Extensions (SMX) support function.</p> <p>Options available: Enable, Disable. Default setting is <b>Disable</b>.</p>
AES-NI	<p>Enable/Disable the AES-NI support.</p> <p>Options available: Enable, Disable. Default setting is <b>Enable</b>.</p>
Debug Consent	Options available: Enable, Disable. Default setting is <b>Disable</b> .

Parameter	Description
Memory Encryption (TME) <sup>(Note)</sup>	Enable/Disable memory encryption (TME). Options available: Enabled, Disabled. Default setting is <b>Disabled</b> .
Total Memory Encryption Multi-Tenant (TME-MT)	Options available: Enabled, Disabled. Default setting is <b>Disabled</b> .
Processor CFR Configuration	<p>Press [Enter] to configure advanced items.</p> <ul style="list-style-type: none"> <li>◆ Provision S3M CFR <ul style="list-style-type: none"> <li>– Options available: Disable, Enable. Default setting is <b>Enable</b>.</li> </ul> </li> <li>◆ Manual Commit S3M FW CFR <ul style="list-style-type: none"> <li>– Options available: Disable, Enable, Auto. Default setting is <b>Auto</b>.</li> </ul> </li> <li>◆ Provision PUcode CFR <ul style="list-style-type: none"> <li>– Options available: Disable, Enable. Default setting is <b>Enable</b>.</li> </ul> </li> <li>◆ Manual Commit PUcode CFR <ul style="list-style-type: none"> <li>– Options available: Enable, Disable, Auto. Default setting is <b>Auto</b>.</li> </ul> </li> <li>◆ Socket0 CFR Revision Info <ul style="list-style-type: none"> <li>– Displays CFR Revision information of the socket.</li> </ul> </li> </ul>

(Note) Advanced items prompt when this item is defined.

### 5-3-2 Common RefCode Configuration

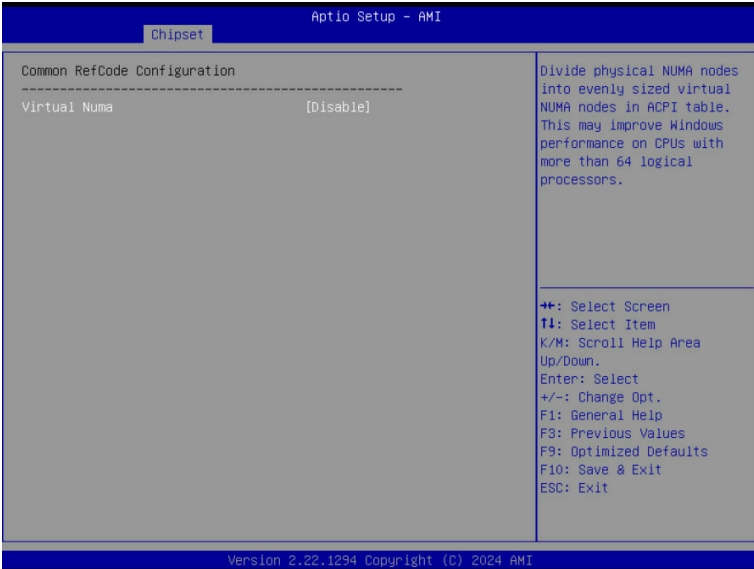

Parameter	Description
Common RefCode Configuration	
Numa	Default setting is <b>Enable</b> .
Virtual Numa	Divide physical NUMA nodes into evenly sized virtual NUMA nodes in ACPI table. This may improve Windows performance on CPUs with more than 64 logical processors. Options available: Enable, Disable. Default setting is <b>Disable</b> .

### 5-3-3 UPI Configuration

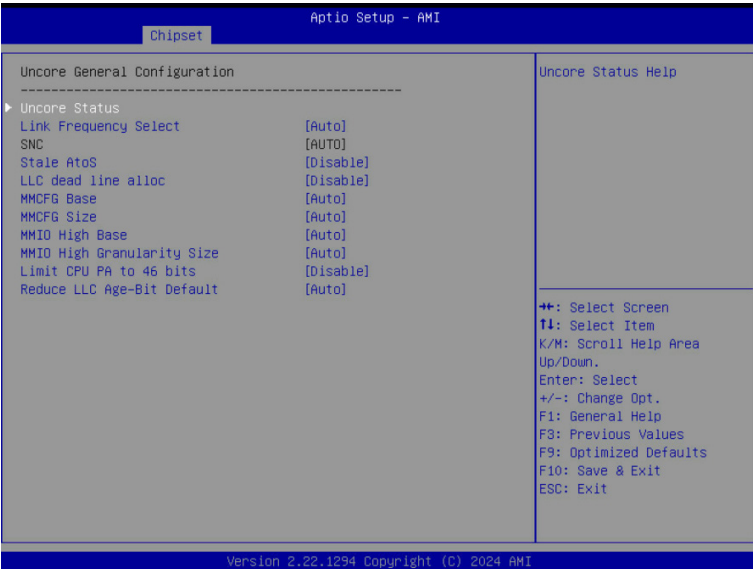
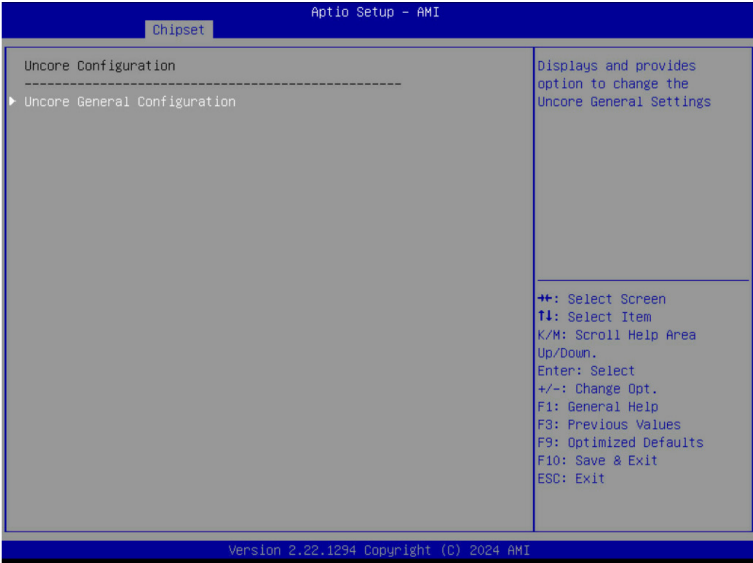



Parameter	Description
UPI General Configuration	<p>Press [Enter] to configure advanced items.</p> <ul style="list-style-type: none"> <li>◆ UPI Status <ul style="list-style-type: none"> <li>– Press [Enter] to view the Uncore status.</li> </ul> </li> <li>◆ Link Frequency Select <ul style="list-style-type: none"> <li>– Selects the UPI link frequency.</li> <li>– Options available: 12.8GT/s, 14.4GT/s, 16.0GT/s, Auto, Use Per Link Setting. Default setting is <b>Auto</b>.</li> </ul> </li> <li>◆ SNC <ul style="list-style-type: none"> <li>– Enable/Disable Sub NUMA Cluster function.</li> <li>– Options available: Auto, Disable, Enable SNC2 (2-clusters), Enable SNC4 (4-clusters). Default setting is <b>Auto</b>.</li> </ul> </li> <li>◆ Stale AtoS <ul style="list-style-type: none"> <li>– Enable/Disable Stale A to S directory optimization.</li> <li>– Options available: Disable, Enable, Auto. Default setting is <b>Auto</b>.</li> </ul> </li> <li>◆ LLC dead line alloc <ul style="list-style-type: none"> <li>– Enable/Disable fill dead lines in LLC.</li> <li>– Options available: Disable, Enable, Auto. Default setting is <b>Enable</b>.</li> </ul> </li> <li>◆ MMCFG Size <ul style="list-style-type: none"> <li>– Options available: 64M, 128M, 256M, 512M, 1G, 2G, Auto. Default setting is <b>512M</b>.</li> </ul> </li> <li>◆ MMIO High Base <ul style="list-style-type: none"> <li>– Options available: 56T, 40T, 32T, 24T, 16T, 4T, 2T, 1T, 512G, 3584T. Default setting is <b>4T</b>.</li> </ul> </li> </ul>



Parameter	Description
UPI General Configuration (continued)	<ul style="list-style-type: none"> <li data-bbox="352 142 956 252">◆ MMIO High Granularity Size <ul style="list-style-type: none"> <li data-bbox="384 169 956 192">– Selects the allocation size used to assign mmioh resources.</li> <li data-bbox="384 200 956 252">– Options available: 1G, 4G, 16G, 64G, 256G, 1024G. Default setting is <b>64G</b>.</li> </ul> </li> <li data-bbox="352 260 956 313">◆ Limit CPU PA to 46 bits <ul style="list-style-type: none"> <li data-bbox="384 286 956 313">– Options available: Disable, Enable. Default setting is <b>Disable</b>.</li> </ul> </li> </ul>

### 5-3-4 Memory Configuration

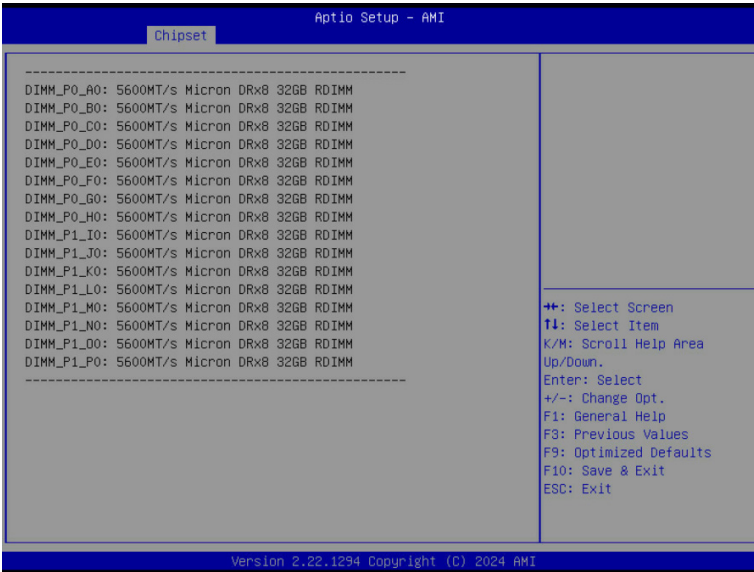
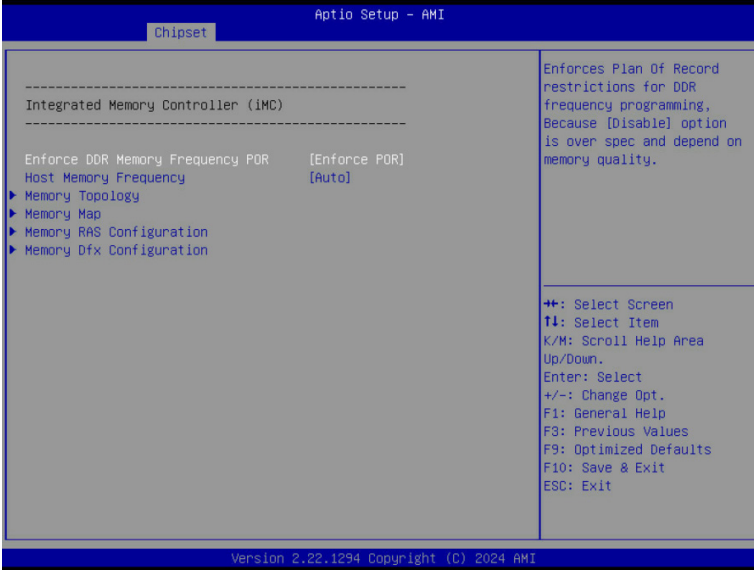

Aptio Setup - AMI

Chipset

Intel(R) Flat Memory Mode Support [Disabled] DDR CXL Heterogeneous Interleave support [Disabled]	Enable or disable Intel(R) Flat Memory Mode support
---	---

++: Select Screen  
 T4: Select Item  
 K/M: Scroll Help Area Up/Down.  
 Enter: Select  
 +/-: Change Opt.  
 F1: General Help  
 F3: Previous Values  
 F9: Optimized Defaults  
 F10: Save & Exit  
 ESC: Exit

Version 2.22.1294 Copyright (C) 2024 AMI

Aptio Setup - AMI

Chipset

----- Memory RAS Configuration Setup -----  Mirror Mode [Disabled] Correctable Error Threshold 7FFF Leaky bucket time window based interface [Disabled] Leaky bucket low bit 28 Leaky bucket high bit 29 ADDDC Sparing [Disabled] Patrol Scrub [Disabled] DDR5 ECS [Enabled]	Full Mirror Mode will set entire 1LM memory in system to be mirrored, consequently reducing the memory capacity by half. Partial Mirror Mode will enable the required size of memory to be mirrored. If rank sparing is enabled partial mirroring will not take effect. Enabling any
---	--

++: Select Screen  
 T4: Select Item  
 K/M: Scroll Help Area Up/Down.  
 Enter: Select  
 +/-: Change Opt.  
 F1: General Help  
 F3: Previous Values  
 F9: Optimized Defaults  
 F10: Save & Exit  
 ESC: Exit

Version 2.22.1294 Copyright (C) 2024 AMI

Chipset      Aptio Setup - AMI

---

Memory Dfx Configuration      ▲ Valid values: 0-7

-----

DCA RX DFE Gain Coefficient	[Disabled]
DCS RX DFE Gain Coefficient	[Disabled]
CXL Persistent Mem Partition Size	0
DFE READ Loopcount	64
Custom Refresh Enable	[Disable]
2DPC 5600 DIMM Frequency Limit	[Auto]
Reduce IMAX by serializing MRC training	[Auto]
Enable/Disable RxRetraining for all CPUs	[Auto]
Enable/Disable TxRetraining for all CPUs	[Auto]
Turnaround Calculation Debug Feature	[Disable]
DB Rx DQ CTLE Enable	[Disable]
DB Rx DQ CTLE Setting	0
DDK Duty Cycle PIE Offset Range	5
Dummy Read Enable(1)/Disable (0)	[Enable]
MCR PDA Enum Errata	[Enable]
Enable(1)/Disable (0)	
MCR PDA Enum Errata TX DQS PIE OFFSET	70
Pmic Secure Mode	[Auto]

▲ Select Screen  
 ↓ Select Item  
 K/M: Scroll Help Area Up/Down.  
 Enter: Select  
 +/-: Change Opt.  
 F1: General Help  
 F3: Previous Values  
 F9: Optimized Defaults  
 F10: Save & Exit  
 ESC: Exit

---

Version 2.22.1294 Copyright (C) 2024 AMI

Chipset      Aptio Setup - AMI

---

DCS DFE Tap 4 Coefficient	0	▲ Enable Turnaround Checkpoint  ▲ Select Screen ↓ Select Item K/M: Scroll Help Area Up/Down. Enter: Select +/-: Change Opt. F1: General Help F3: Previous Values F9: Optimized Defaults F10: Save & Exit ESC: Exit
RX DFE Gain Control	[Disable]	
Back to Back RMT Loop Count	1	
RMT Lane Print Per Pseudo Channel	[Disable]	
Db Mdq Vref overrides	[Disable]	
DFX Override To Skip DutyCycle At End Of WriteDqDqsPreDfe2DCentering	[Disable]	
DFX Override To Skip DutyCycle At End Of WriteDqDqsPostDfe2DCentering	[Enable]	
Mem IO Health CMD check	[Enable]	
TR optimal value skip programming	[Disable]	
Dfx HR CRC feature Control	[Disable]	
Directory Mode Override	[Disable]	
Pctle Enable	[Disable]	
Pctle Res1 Ct1	[3]	
Pctle Cap1 Ct1	[125]	
Cgcs R100	[5]	
Enable Rx Jitter Cancellation Training for RDIMM	[Auto]	
Enable Dram Duty Cycle Adjust Per-bit Training for RDIMM	[Auto]	
Sense Amp DQ Delay Optimization pull-back constant table option	[Option 1]	
Turnaround Checkpoint	[Auto]	

---

Version 2.22.1294 Copyright (C) 2024 AMI

Parameter	Description
Integrated Memory Controller (iMC)	
Enforce DDR Memory Frequency POR	When set to Enable, the system enforces Plan Of Record restrictions for DDR frequency programming. Options available: POR, Disable. Default setting is <b>POR</b> .
Memory Frequency	Configures the maximum memory frequency. If Enforce POR is disabled, user will be able to run at higher frequencies than the memory support (limited by processor support). Default setting is <b>Auto</b> .
Enable ADR	Enables the detecting and enabling of ADR (Asynchronous DRAM Refresh) function. Options available: Enable, Disable. Default setting is <b>Enable</b> .
Legacy ADR Mode	Enable/Disable the Legacy ADR Mode. Options available: Enable, Disable, Auto. Default setting is <b>Auto</b> .
Minimum System Memory Size	Configures the minimum memory size. Options available: 2GB, 4GB, 6GB, 8GB. Default setting is <b>2GB</b> .
ADR Data Save Mode	Specifies the Data Save Mode for ADR. Batterybacked or Type 01 NVDIMM. Options available: Disable, Batterybacked DIMMs, NVDIMMs, Copy to Flash. Default setting is <b>NVDIMMs</b> .
Assert ADR on Reset	Enable/Disable Assert ADR on Reset. Options available: Enabled, Disabled. Default setting is <b>Disabled</b> .

Parameter	Description
Assert ADR on S5	Enable/Disable Assert ADR on S5. Options available: Enabled, Disabled. Default setting is <b>Disabled</b> .
Get Memory Timing	Auto is the detected SPD value and use it, otherwise use BIOS Build-in. Options available: Auto, BIOS Build-in. Default setting is <b>BIOS Build-in</b> .
Memory Topology	Press [Enter] to view memory topology with DIMM population information.
Memory Map <sup>(Note1)</sup>	Press [Enter] to configure advanced items. <ul style="list-style-type: none"> <li>◆ Volatile Memory Mode <ul style="list-style-type: none"> <li>– Selects 1LM or 2LM mode for volatile memory.</li> <li>– Options available: 1LM, 2LM. Default setting is <b>2LM</b>.</li> </ul> </li> </ul>
Memory RAS Configuration	Press [Enter] to configure advanced items. <ul style="list-style-type: none"> <li>◆ Mirror Mode<sup>(Note2)</sup> <ul style="list-style-type: none"> <li>– Mirror Mode will set entire 1LM memory in system to be mirrored, consequently reducing the memory capacity by half. Enables the Mirror Mode will disable the XPT Prefetch.</li> <li>– Options available: Disabled, Full Mirror Mode, Partial Mirror Mode. Default setting is <b>Disabled</b>.</li> </ul> </li> <li>◆ Partial Mirror 1 Size (GB) <ul style="list-style-type: none"> <li>– Selects multiplier of 1GB for the size of the SAD to be created.</li> </ul> </li> <li>◆ Correctable Error Threshold <ul style="list-style-type: none"> <li>– Correctable Error Threshold (0x01-0x7fff) used for sparing, and leaky bucket.</li> <li>– Press the &lt;+&gt; / &lt;-&gt; keys to increase or decrease the desired values.</li> </ul> </li> <li>◆ Trigger SW Error Threshold<sup>(Note2)</sup> <ul style="list-style-type: none"> <li>– Enable/Disable Sparing trigger SW Error Match Threshold.</li> <li>– Options available: Disabled, Enabled. Default setting is <b>Disabled</b>.</li> </ul> </li> <li>◆ SW Per Bank Threshold <ul style="list-style-type: none"> <li>– SW Per Bank Threshold (1-0x7FFF) used for DDR bank level error.</li> <li>– Press the &lt;+&gt; / &lt;-&gt; keys to increase or decrease the desired values.</li> </ul> </li> <li>◆ SW Correctable Error Time Window <ul style="list-style-type: none"> <li>– SW Correctable Error time window based interface in hour (0-24).</li> <li>– Press the &lt;+&gt; / &lt;-&gt; keys to increase or decrease the desired values.</li> </ul> </li> <li>◆ Leaky bucket time window based interface<sup>(Note2)</sup> <ul style="list-style-type: none"> <li>– Enable/Disable leaky bucket time window based interface.</li> <li>– Options available: Disabled, Enabled. Default setting is <b>Disabled</b>.</li> </ul> </li> </ul>

(Note1) Advanced items prompt when HBM CPU is installed.

(Note2) Advanced items prompt when this item is defined.

Parameter	Description
Memory RAS Configuration (continued)	<ul style="list-style-type: none"> <li>◆ Leaky bucket time window based interface Hour <ul style="list-style-type: none"> <li>– Leaky bucket time window based interface hour used for DDR (0-24).</li> <li>– Press the &lt;+&gt; / &lt;-&gt; keys to increase or decrease the desired values.</li> </ul> </li> <li>◆ Leaky bucket time window based interface Minute <ul style="list-style-type: none"> <li>– Leaky bucket time window based interface minute used for DDR (0-60).</li> <li>– Press the &lt;+&gt; / &lt;-&gt; keys to increase or decrease the desired values.</li> </ul> </li> <li>◆ Leaky bucket low bit <ul style="list-style-type: none"> <li>– Configures leaky bucket low bit (0x1 - 0x29).</li> <li>– Press the &lt;+&gt; / &lt;-&gt; keys to increase or decrease the desired values.</li> </ul> </li> <li>◆ Leaky bucket high bit <ul style="list-style-type: none"> <li>– Configures leaky bucket high bit (0x1 - 0x29).</li> <li>– Press the &lt;+&gt; / &lt;-&gt; keys to increase or decrease the desired values.</li> </ul> </li> <li>◆ ADDDC Sparing<sup>(Note)</sup> <ul style="list-style-type: none"> <li>– Enable/Disable ADDDC Sparing.</li> <li>– Options available: Disabled, Enabled. Default setting is <b>Disabled</b>.</li> </ul> </li> <li>◆ Enable ADDDC Error Injection <ul style="list-style-type: none"> <li>– Options available: Disabled, Enabled. Default setting is <b>Enabled</b>.</li> </ul> </li> <li>◆ Patrol Scrub <ul style="list-style-type: none"> <li>– Options available: Disabled, Enable at End of POST. Default setting is <b>Enable at End of POST</b>.</li> </ul> </li> <li>◆ Patrol Scrub Interval <ul style="list-style-type: none"> <li>– Selects the number of hours (1-24) required to complete full scrub. A value of zero means auto.</li> </ul> </li> <li>◆ DDR5 ECS <ul style="list-style-type: none"> <li>– Options available: Disabled, Enabled, Enable ECS with Result Collection. Default setting is <b>Enabled</b>.</li> </ul> </li> </ul>

(Note) Advanced items prompt when this item is defined.

### 5-3-5 IIO Configuration

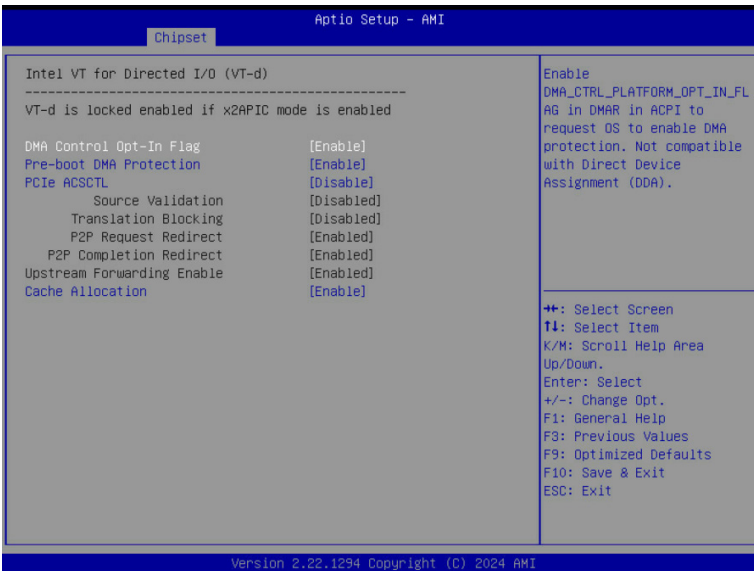
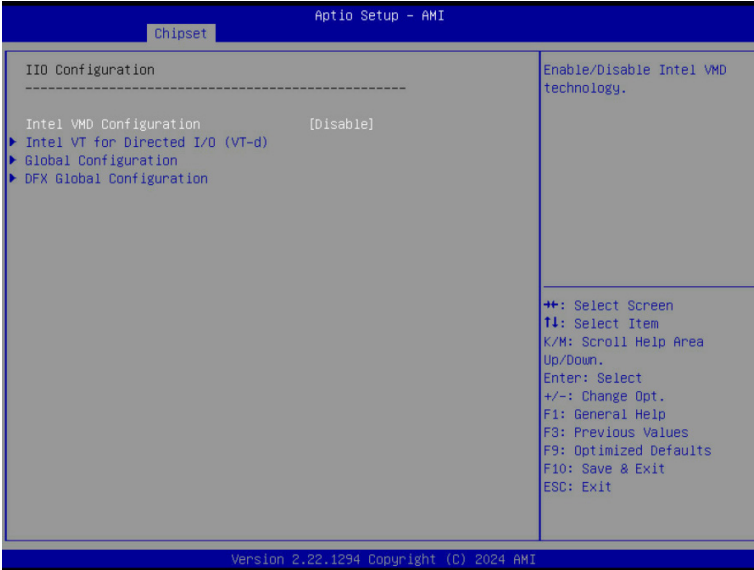



Chipset		Aptio Setup - AMI
Global Configuration		This option can set Max Read Request Size in PCI hierarchy. 'Default' keeps hardware default.
Max Read Request Size	[4096B]	
Relaxed Ordering	[Enable]	
		+*: Select Screen ↑↓: Select Item K/M: Scroll Help Area Up/Down. Enter: Select +/-: Change Opt. F1: General Help F3: Previous Values F9: Optimized Defaults F10: Save & Exit ESC: Exit
Version 2.22.1294 Copyright (C) 2024 AMI		

Chipset		Aptio Setup - AMI
DFX Global Configuration		Expose IID DFX devices and other CPU devices like PMON
-----		
EV DFX Features	[Disable]	
Disable BIOS Done	[Disabled]	
Link Re-Train	[Disable]	
Skip IID RC flow	[Disable]	
Skip PCIe Link Training	[No]	
Skip Port Personality Lock	[Disable]	
CXL Header Bypass	[Enable]	
CXL 1.1 as 2.0 mode	[Disable]	
MSE/BME En	[Disable]	
LVF Test Card Workarounds	[Disable]	
CXL IDE	[Disable]	
Trace Hub Allocating Flow	[Enable]	
Compliance Mode	[Disable]	
Equalization Bypass	[Disable]	
▶ UBA Hot-Plug Override		
		+*: Select Screen ↑↓: Select Item K/M: Scroll Help Area Up/Down. Enter: Select +/-: Change Opt. F1: General Help F3: Previous Values F9: Optimized Defaults F10: Save & Exit ESC: Exit
Version 2.22.1294 Copyright (C) 2024 AMI		

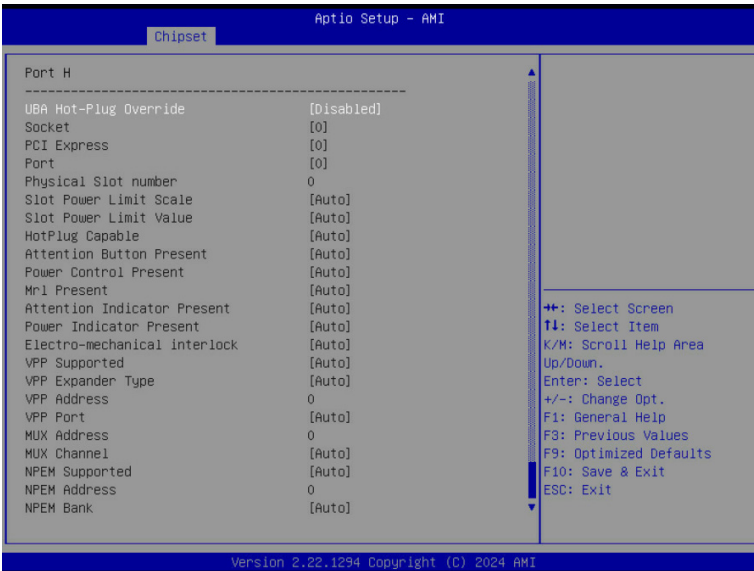
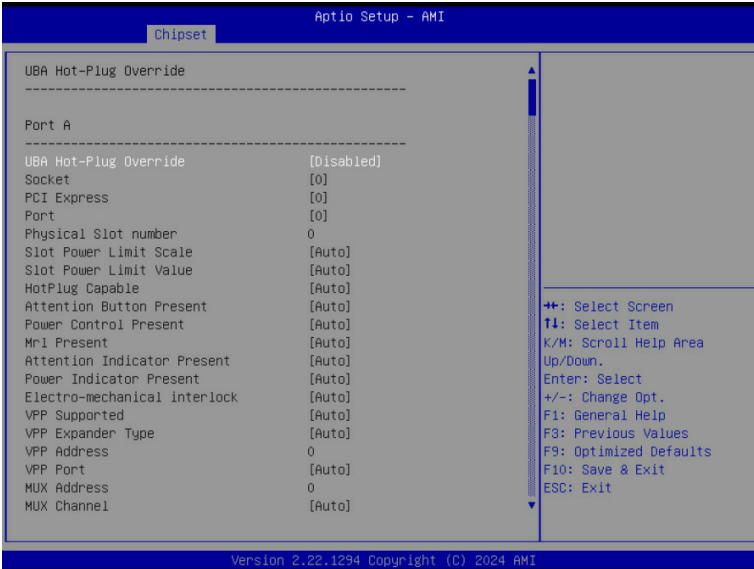

Parameter	Description
I/O Configuration	
Intel® VT for Directed I/O (VT-d)	<p data-bbox="380 183 713 205">Press [Enter] to configure advanced items.</p> <ul style="list-style-type: none"> <li data-bbox="380 213 953 351">◆ Intel® VT for Directed I/O <ul style="list-style-type: none"> <li data-bbox="416 241 953 323">– Enable/Disable the Intel VT for Directed I/O (VT-d) support function by reporting the I/O device assignment to VMM through DMAR ACPI Tables.</li> <li data-bbox="416 330 916 351">– Options available: Enable, Disable. Default setting is <b>Enable</b>.</li> </ul> </li> <li data-bbox="380 359 916 410">◆ Cache Allocation <ul style="list-style-type: none"> <li data-bbox="416 387 916 410">– Options available: Enable, Disable. Default setting is <b>Enable</b>.</li> </ul> </li> <li data-bbox="380 418 953 556">◆ DMA Control Opt-In Flag <ul style="list-style-type: none"> <li data-bbox="416 446 953 528">– Enable/Disable DMA_CTRL_PLATFORM_OPT_IN_FLAG in DMAR table in ACPI. Not compatible with Direct Device Assignment (DDA).</li> <li data-bbox="416 536 921 556">– Options available: Enable, Disable. Default setting is <b>Disable</b>.</li> </ul> </li> <li data-bbox="380 564 884 646">◆ Interrupt Remapping <ul style="list-style-type: none"> <li data-bbox="416 592 884 616">– Enable/Disable the interrupt remapping support function.</li> <li data-bbox="416 624 942 646">– Options available: Auto, Enable, Disable. Default setting is <b>Auto</b></li> </ul> </li> <li data-bbox="380 653 921 705">◆ x2APIC Opt Out <ul style="list-style-type: none"> <li data-bbox="416 682 921 705">– Options available: Enable, Disable. Default setting is <b>Disable</b>.</li> </ul> </li> <li data-bbox="380 713 921 765">◆ Pre-boot DMA Protection <ul style="list-style-type: none"> <li data-bbox="416 741 921 765">– Options available: Enable, Disable. Default setting is <b>Disable</b>.</li> </ul> </li> </ul>

Parameter	Description
Intel® VT for Directed I/O (VT-d) (continued)	<ul style="list-style-type: none"> <li>◆ PCIe ACSCTL <ul style="list-style-type: none"> <li>– Enable/Disable overwrite of PCI Access Control Services Control register in PCI root ports.</li> <li>– Options available: Disable, Enable. Default setting is <b>Disable</b>.</li> </ul> </li> <li>◆ Source Validation<sup>(Note)</sup> <ul style="list-style-type: none"> <li>– Options available: Disabled, Enabled. Default setting is <b>Disabled</b>.</li> </ul> </li> <li>◆ Translation Blocking<sup>(Note)</sup> <ul style="list-style-type: none"> <li>– Options available: Disabled, Enabled. Default setting is <b>Disabled</b>.</li> </ul> </li> <li>◆ P2P Request Redirect<sup>(Note)</sup> <ul style="list-style-type: none"> <li>– Options available: Disabled, Enabled. Default setting is <b>Enabled</b>.</li> </ul> </li> <li>◆ P2P Completion Redirect<sup>(Note)</sup> <ul style="list-style-type: none"> <li>– Options available: Disabled, Enabled. Default setting is <b>Enabled</b>.</li> </ul> </li> <li>◆ Upstream Forwarding Enable<sup>(Note)</sup> <ul style="list-style-type: none"> <li>– Options available: Disabled, Enabled. Default setting is <b>Enabled</b>.</li> </ul> </li> </ul>
Intel® VMD technology	<p>Press [Enter] to configure advanced items.</p> <ul style="list-style-type: none"> <li>◆ Intel® VMD Configuration <ul style="list-style-type: none"> <li>– Enable/Disable Intel® VMD technology.</li> <li>– Options available: Enable, Disable. Default setting is <b>Disable</b>.</li> </ul> </li> <li>◆ Intel® VMD for Non-Hotplug NVMe<sup>(Note1)</sup> <ul style="list-style-type: none"> <li>– Enable/Disable Intel® VMD for Non-Hotplug NVMe.</li> <li>– Options available: Enable, Disable. Default setting is <b>Disable</b>.</li> </ul> </li> </ul>
I/O-PCIe Express Global Options	
PCIe Max Read Request Size	Options available: Auto, 128B, 256B, 512B, 1024B, 2048B, 4096B. Default setting is <b>4096B</b> .
Pcie Relaxed Ordering	Options available: No, Yes. Default setting is <b>Yes</b> .

(Note) This item is available when **PCIe ACSCTL** is set to **Enable**.

(Note1) This item appears when **Intel® VMD Configuration** is set to **Enable**.

### 5-3-6 Advanced Power Management Configuration

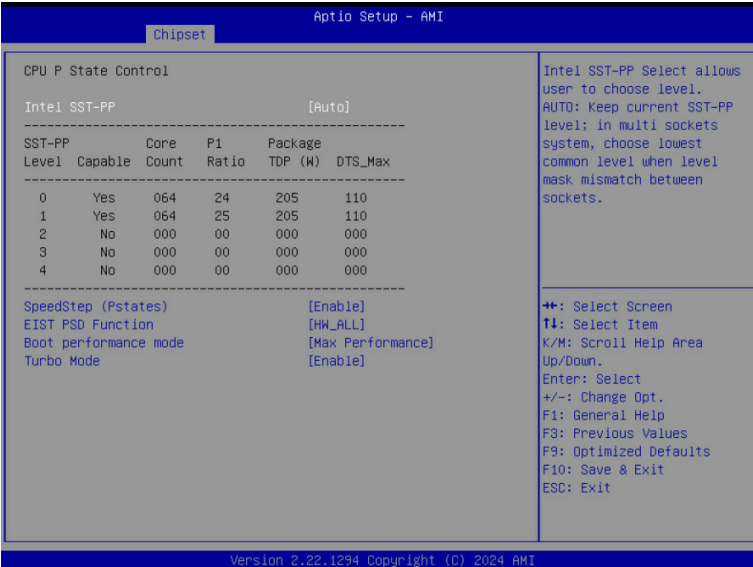
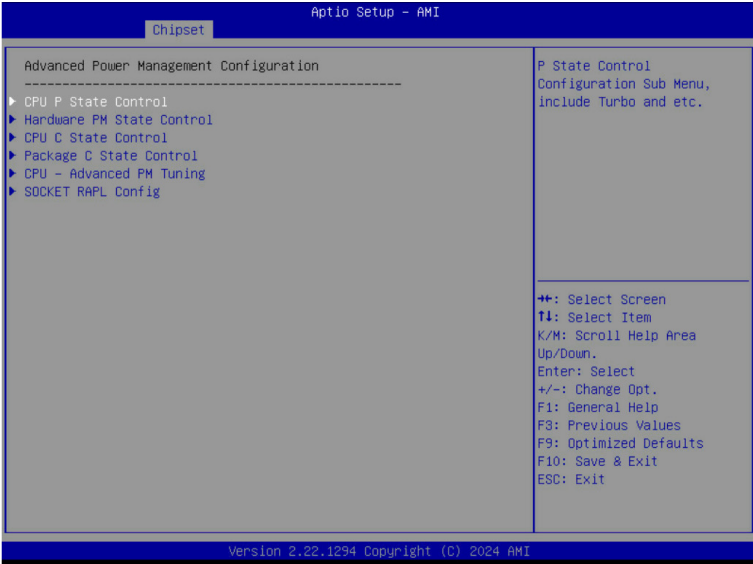

Chipset		Aptio Setup - AMI	
Hardware PM State Control		Disable: Hardware chooses a P-state based on OS Request (Legacy P-States)	
Hardware P-States	[Native Mode]	Native Mode:Hardware chooses a P-state based on OS guidance	
HardwarePM Interrupt	[Disable]	Out of Band Mode:Hardware autonomously chooses a P-state (no OS guidance)	
		NOTE: When HWP is 'Disable' or 'OOB',	
		⇧⇧: Select Screen ⇧: Select Item K/M: Scroll Help Area Up/Down. Enter: Select +/-: Change Opt. F1: General Help F3: Previous Values F9: Optimized Defaults F10: Save & Exit ESC: Exit	
Version 2.22.1294 Copyright (C) 2024 AMI			

Chipset		Aptio Setup - AMI	
CPU C State Control		Allows Monitor and MWAIT instructions.	
Monitor MWAIT	[Enable]		
ACPI C1 Enumeration	[C1e]		
ACPI C6x Enumeration	[C6S as ACPI C3]		
		⇧⇧: Select Screen ⇧: Select Item K/M: Scroll Help Area Up/Down. Enter: Select +/-: Change Opt. F1: General Help F3: Previous Values F9: Optimized Defaults F10: Save & Exit ESC: Exit	
Version 2.22.1294 Copyright (C) 2024 AMI			

Aptio Setup - AMI	
Chipset	
Package C State Control Package C State [C0/C1 state]	Package C State limit, the state Auto maps is program specific.  ++: Select Screen ↑↓: Select Item K/M: Scroll Help Area Up/Down. Enter: Select +/-: Change Opt. F1: General Help F3: Previous Values F9: Optimized Defaults F10: Save & Exit ESC: Exit
Version 2.22.1294 Copyright (C) 2024 AMI	

Aptio Setup - AMI	
Chipset	
CPU - Advanced PM Tuning ----- Current Uncore Ratio Range: 08 - 22 ----- Uncore Freq Ratio: 0 ▶ Energy Perf BIAS	0: Set dynamic Uncore frequency range from max and min fused values. Otherwise Uncore will run at a constant frequency ratio, the UFS algorithm will be disabled, but physical limits may still reduce frequency.  ++: Select Screen ↑↓: Select Item K/M: Scroll Help Area Up/Down. Enter: Select +/-: Change Opt. F1: General Help F3: Previous Values F9: Optimized Defaults F10: Save & Exit ESC: Exit
Version 2.22.1294 Copyright (C) 2024 AMI	

Aptio Setup - AMI

Chipset

<p>Energy Perf BIAS</p> <p>Power Performance Tuning [BIOS Controls EPB] ENERGY_PERF_BIAS_CFG mode [Performance]</p>	<p>Options decide who Controls EPB. In OS mode: IA32_ENERGY_PERF_BIAS is used In BIOS mode: ENERGY_PERF_BIAS_CONFIG is used In PECI mode: PCS53 is used</p> <hr/> <p>           ++: Select Screen            T4: Select Item            K/M: Scroll Help Area Up/Down.            Enter: Select            +/-: Change Opt.            F1: General Help            F3: Previous Values            F9: Optimized Defaults            F10: Save &amp; Exit            ESC: Exit         </p>
---	--

Version 2.22.1294 Copyright (C) 2024 AMI

Aptio Setup - AMI

Chipset

<p>SOCKET RAPL Config</p> <p>PL1 Power Limit 0 PL1 Time Window [1] PL2 Power Limit 0 PL2 Time Window [0.012]</p>	<p>PL1 Power Limit in Watts. The value may vary from 0 to Fused TDP Value. If the value is 0, the Fused TDP value will be programmed. A value greater than Fused TDP value will not be programmed.</p> <hr/> <p>           ++: Select Screen            T4: Select Item            K/M: Scroll Help Area Up/Down.            Enter: Select            +/-: Change Opt.            F1: General Help            F3: Previous Values            F9: Optimized Defaults            F10: Save &amp; Exit            ESC: Exit         </p>
--	---

Version 2.22.1294 Copyright (C) 2024 AMI



Parameter	Description
CPU P State Control	<p>Press [Enter] to configure advanced items.</p> <ul style="list-style-type: none"> <li>◆ SpeedStep (Pstates) <ul style="list-style-type: none"> <li>– Conventional Intel SpeedStep Technology switches both voltage and frequency in tandem between high and low levels in response to processor load.</li> <li>– Options available: Enable, Disable. Default setting is <b>Enable</b>.</li> </ul> </li> <li>◆ Turbo Mode <ul style="list-style-type: none"> <li>– When this item is enabled, the processor will automatically ramp up the clock speed of 1-2 of its processing cores to improve its performance. When this item is disabled, the processor will not overclock any of its core.</li> <li>– Options available: Enable, Disable. Default setting is <b>Enable</b>.</li> </ul> </li> </ul>
Hardware PM State Control	<p>Press [Enter] to configure advanced items.</p> <ul style="list-style-type: none"> <li>◆ Hardware P-States <ul style="list-style-type: none"> <li>– When this item is disabled, the processor hardware chooses a P-state based on OS Request (Legacy P-States).</li> <li>– In Native mode, the processor hardware chooses a P-state based on OS guidance.</li> <li>– In Out of Band mode, the processor hardware autonomously chooses a P-state (with no OS guidance).</li> <li>– Options available: Disable, Native Mode, Out of Band Mode, Native Mode with No Legacy Support. Default setting is <b>Native Mode</b>.</li> </ul> </li> </ul>

Parameter	Description
CPU C State Control	<p>Press [Enter] to configure advanced items.</p> <ul style="list-style-type: none"> <li>◆ Enable Monitor MWAIT <ul style="list-style-type: none"> <li>– Allows Monitor and MWAIT instructions.</li> <li>– Options available: Disable, Enable, Auto. Default setting is <b>Auto</b>.</li> </ul> </li> <li>◆ CPU C6 Report <ul style="list-style-type: none"> <li>– Enable/Disable CPU C6(ACPI C3) report to OS.</li> <li>– Options available: Disable, Enable, Auto. Default setting is <b>Auto</b>.</li> </ul> </li> <li>◆ Enhanced Halt State (C1E) <ul style="list-style-type: none"> <li>– Core C1E auto promotion control. Takes effect after reboot.</li> <li>– Options available: Enable, Disable. Default setting is <b>Enable</b>.</li> </ul> </li> </ul>
Package C State Control	<p>Press [Enter] to configure advanced items.</p> <ul style="list-style-type: none"> <li>◆ Package C State <ul style="list-style-type: none"> <li>– Configures the state for the C-State package limit.</li> <li>– Options available: C0/C1 state, C2 state, C6(non Retention) state, C6(Retention) state, No Limit, Auto. Default setting is <b>Auto</b>.</li> </ul> </li> </ul>
CPU - Advanced PM Tuning	<p>Press [Enter] to configure advanced items.</p> <ul style="list-style-type: none"> <li>◆ Energy Perf BIAS <ul style="list-style-type: none"> <li>– Press [Enter] to configure advanced items. <ul style="list-style-type: none"> <li>» Power Performance Tuning <ul style="list-style-type: none"> <li>• Options available: OS Controls EPB, BIOS Controls EPB, PECL Controls EPB. Default setting is <b>OS Controls EPB</b>.</li> </ul> </li> <li>» Energy_PERF_BIAS_CFG mode<sup>(Note)</sup> <ul style="list-style-type: none"> <li>• Options available: Performance, Balanced Performance, Balanced Power, Power. Default setting is <b>Balanced Performance</b>.</li> </ul> </li> </ul> </li> </ul> </li> </ul>
SOCKET RAPL Config	<p>Press [Enter] to configure advanced items.</p> <ul style="list-style-type: none"> <li>◆ PL1 Power Limit <ul style="list-style-type: none"> <li>– PL1 Power Limit in Watts. The value may vary from 0 to Fused Value. If the value is 0, the fused value will be programmed.</li> <li>– Default setting is <b>0</b>.</li> </ul> </li> <li>◆ PL1 Time Window <ul style="list-style-type: none"> <li>– PL1 value in seconds. The value may vary from 0 to 448.</li> <li>– Default setting is <b>1</b>.</li> </ul> </li> <li>◆ PL2 Power Limit <ul style="list-style-type: none"> <li>– PL2 Power Limit in Watts. The value may vary from 0 to Fused Value. If the value is 0, BIOS programs 120% * TDP.</li> <li>– Default setting is <b>0</b>.</li> </ul> </li> <li>◆ PL2 Time Window <ul style="list-style-type: none"> <li>– PL1 value in seconds. The value may vary from 0 to 0.438.</li> <li>– Default setting is <b>0.012</b>.</li> </ul> </li> </ul>

(Note) This item is configurable when **Power Performance Tuning** is set to **BIOS Controls EPB**.

### 5-3-7 Miscellaneous Configuration

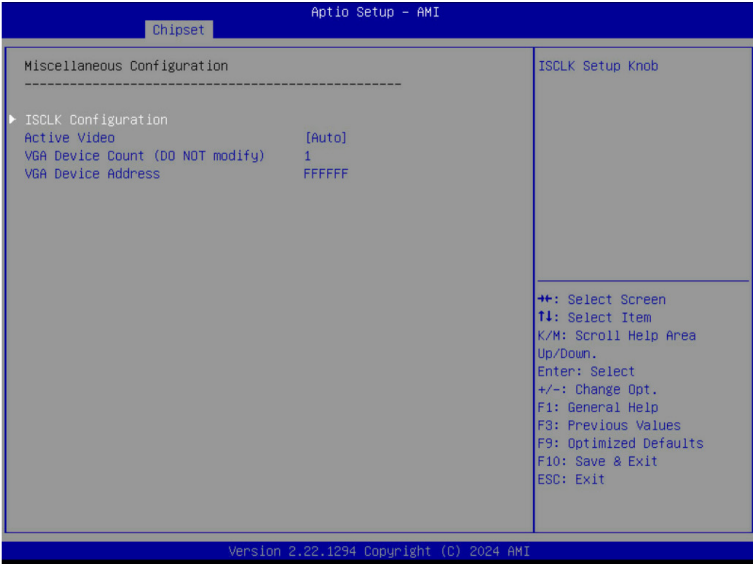

Parameter	Description
Miscellaneous Configuration	
Active Video	Selects the active video type. Options available: Auto, Onboard Device, PCIE Device, Specific PCIE Device. Default setting is <b>Auto</b> .
External SSC - CK440	Enables Spread spectrum - only affects external clock generator. Options available: SSC Off, SSC = -0.3%, SSC = -0.5%, Hardware. Default setting is <b>SSC Off</b> .

### 5-3-8 Runtime Error Logging Settings

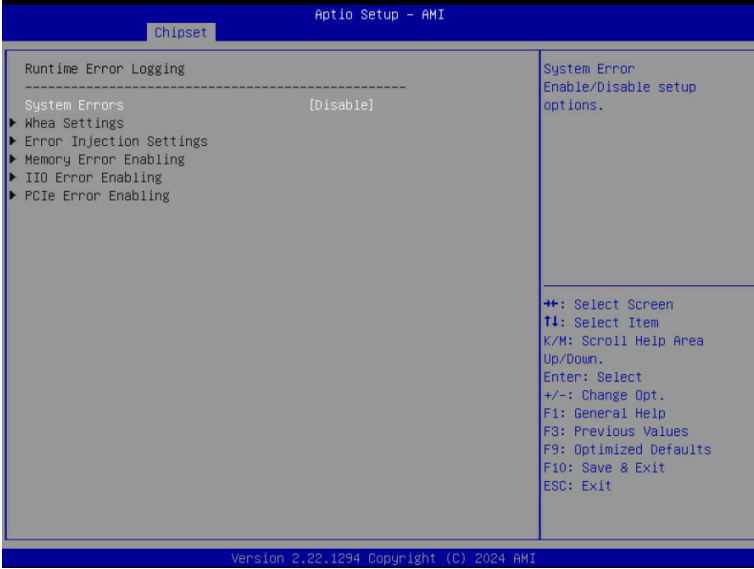

Parameter	Description
Runtime Error Logging	
System Errors	Enable/Disable system error logging function. Options available: Enable, Disable. Default setting is <b>Enable</b> .
S/W Error Injection Support	Enable/Disable software injection error logging function. Options available: Enable, Disable. Default setting is <b>Disable</b> .
Whea Settings	Press [Enter] to configure advanced items. <ul style="list-style-type: none"> <li>◆ WHEA (Windows Hardware Error Architecture) Support <ul style="list-style-type: none"> <li>- Enable/Disable WHEA Support.</li> <li>- Options available: Enable, Disable. Default setting is <b>Enable</b>.</li> </ul> </li> </ul>
Memory Error Enabling	Press [Enter] to configure advanced items. <ul style="list-style-type: none"> <li>◆ Memory Corrected Error <ul style="list-style-type: none"> <li>- Enable/Disable Memory Corrected Error.</li> <li>- Options available: Enable, Disable. Default setting is <b>Enable</b>.</li> </ul> </li> <li>◆ Uncorrected Error disable Memory <ul style="list-style-type: none"> <li>- Enable/Disable the Memory that triggers Uncorrected Error.</li> <li>- Options available: Enable, Disable. Default setting is <b>Disable</b>.</li> </ul> </li> </ul>

Parameter	Description
PCIe Error Enabling	<p data-bbox="309 142 642 166">Press [Enter] to configure advanced items.</p> <ul style="list-style-type: none"> <li data-bbox="309 170 852 252">◆ PCIe Error <ul style="list-style-type: none"> <li data-bbox="344 200 580 224">– Enable/Disable PCIe error.</li> <li data-bbox="344 228 852 252">– Options available: Enable, Disable. Default setting is <b>Disable</b>.</li> </ul> </li> <li data-bbox="309 257 923 338">◆ Uncorrected Error<sup>(Note)</sup> <ul style="list-style-type: none"> <li data-bbox="344 286 923 310">– Enables and escalates Uncorrectable/Recoverable Errors to error pins.</li> <li data-bbox="344 315 846 338">– Options available: Enable, Disable. Default setting is <b>Enable</b>.</li> </ul> </li> <li data-bbox="309 343 846 424">◆ Fatal Error Enable<sup>(Note)</sup> <ul style="list-style-type: none"> <li data-bbox="344 373 749 396">– Enables and escalates Fatal Errors to error pins.</li> <li data-bbox="344 401 846 424">– Options available: Enable, Disable. Default setting is <b>Enable</b>.</li> </ul> </li> <li data-bbox="309 429 940 545">◆ Assert NMI on SERR<sup>(Note)</sup> <ul style="list-style-type: none"> <li data-bbox="344 459 940 514">– Enable/Disable BIOS generates a non-maskable interrupt (NMI) and logs an error when a system error (SERR) occurs.</li> <li data-bbox="344 519 876 542">– Options available: Enabled, Disabled. Default setting is <b>Enabled</b>.</li> </ul> </li> <li data-bbox="309 550 940 663">◆ Assert NMI on PERR<sup>(Note)</sup> <ul style="list-style-type: none"> <li data-bbox="344 580 940 635">– Enable/Disable BIOS generates a non-maskable interrupt (NMI) and logs an error when a processor bus parity error (PERR) occurs.</li> <li data-bbox="344 639 876 663">– Options available: Enabled, Disabled. Default setting is <b>Enabled</b>.</li> </ul> </li> </ul>

(Note) This item appears when **PCIe Error** is set to **Enable**.

### 5-3-9 Power Policy



Parameter	Description
Power Policy Quick Settings	Selects a Power Policy Quick Setting. Options available: Standard, Best Performance, Energy Efficient. Default setting is <b>Standard</b> .
SpeedStep (Pstates)	Conventional Intel SpeedStep Technology switches both voltage and frequency in tandem between high and low levels in response to processor load. Options available: Enable, Disable. Default setting is <b>Enable</b> .
Turbo Mode	When this item is enabled, the processor will automatically ramp up the clock speed of 1-2 of its processing cores to improve its performance. When this item is disabled, the processor will not overclock any of its core. Options available: Enable, Disable. Default setting is <b>Enable</b> .
CPU C6 report	Enable/Disable the BIOS to enable the report from the CPU C6 state (ACPI C3) to the OS. Options available: Disable, Enable, Auto. Default setting is <b>Auto</b> .
Enhanced Halt State (C1E)	Enable/Disable the C1E support for lower power consumption. Takes effect after reboot. Options available: Enable, Disable. Default setting is <b>Enable</b> .
Package C State	Configures the C-State package limit. Options available: C0/C1 state, C2 state, C6(non Retention) state, C6(Retention) state, No Limit, Auto. Default setting is <b>Auto</b> .

Parameter	Description
Enable LP [Global]	Enables Logical processor (Software Method to Enable/Disable Logical Processor threads). Options available: ALL LPs, Single LP. Default setting is <b>ALL LPs</b> .
Hardware Prefetcher	Options available: Enable, Disable. Default setting is <b>Enable</b> .
Adjacent Cache Prefetch	Options available: Enable, Disable. Default setting is <b>Enable</b> .
DCU Streamer Prefetcher	Options available: Enable, Disable. Default setting is <b>Enable</b> .
Intel® VT for Directed I/O	Enable/Disable the Intel VT for Directed I/O (VT-d) support function by reporting the I/O device assignment to VMM through DMAR ACPI Tables. Options available: Enable, Disable. Default setting is <b>Enable</b> .

## 5-4 Server Management Menu



Parameter	Description
FRB-2 Timer	Enable/Disable FRB-2 timer (POST timer). Options available: Enabled, Disabled. Default setting is <b>Enabled</b> .
FRB-2 Timer <sup>(Note1)</sup> timeout	Configures the FRB2 Timer timeout. The value is between 1 to 30 minutes. Default setting is <b>6 minutes</b> .
FRB-2 Timer Policy <sup>(Note1)</sup>	Configures the FRB2 Timer policy. Options available: Do Nothing, Reset, Power Down, Power Cycle. Default setting is <b>Do Nothing</b> .
OS Watchdog Timer	Enable/Disable OS Watchdog Timer function. Options available: Enabled, Disabled. Default setting is <b>Disabled</b> .
OS Wtd Timer Timeout <sup>(Note2)</sup>	Configures OS Watchdog Timer. The value is between 1 to 30 minutes. Default setting is <b>10 minutes</b> .
OS Wtd Timer Policy <sup>(Note2)</sup>	Configure OS Watchdog Timer Policy. Options available: Reset, Do Nothing, Power Down, Power Cycle. Default setting is <b>Reset</b> .
Wait BMC Ready	POST wait BMC ready and reboot system. Options available: Disabled, 2 minutes, 4 minutes, 6 minutes. Default setting is <b>2 minutes</b> .

(Note1) This item is configurable when **FRB-2 Timer** is set to **Enabled**.

(Note2) This item is configurable when **OS Watchdog Timer** is set to **Enabled**.



<b>Parameter</b>	<b>Description</b>
System Event Log	Press [Enter] to configure advanced items.
View FRU Information	Press [Enter] to view the FRU information.
BMC VLAN Configuration	Press [Enter] to configure advanced items.
BMC network Configuration	Press [Enter] to configure advanced items.
IPv6 BMC Network Configuration	Press [Enter] to configure advanced items.

## 5-4-1 System Event Log

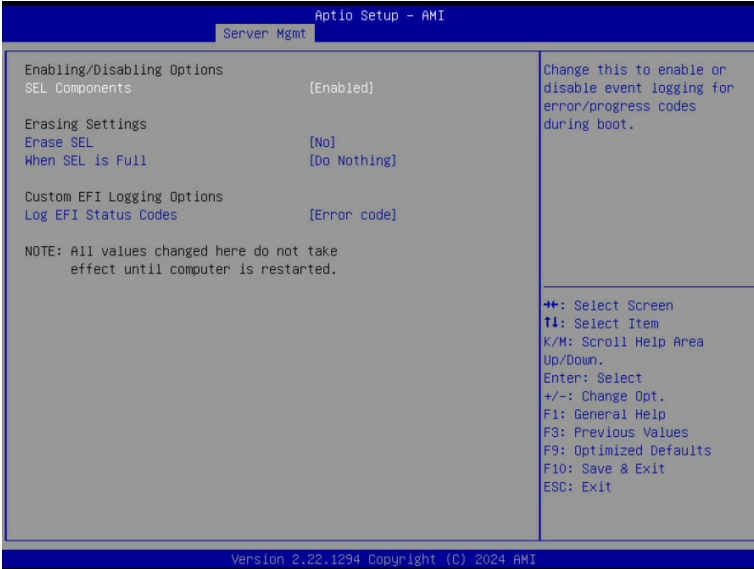

Parameter	Description
Enabling / Disabling Options	
SEL Components	Change this item to enable or disable all features of System Event Logging during boot. Options available: Enabled, Disabled. Default setting is <b>Enabled</b> .
Erasing Settings	
Erase SEL	Choose options for erasing SEL. Options available: No, Yes, On next reset, Yes, On every reset. Default setting is <b>No</b> .
When SEL is Full	Choose options for reactions to a full SEL. Options available: Do Nothing, Erase Immediately, Delete Oldest Record. Default setting is <b>Do Nothing</b> .
Custom EFI Logging Options	
Log EFI Status Codes	Enable/Disable the logging of EFI Status Codes (if not already converted to legacy). Options available: Disabled, Both, Error code, Progress code. Default setting is <b>Error code</b> .

## 5-4-2 View FRU Information

The FRU page is a simple display page for basic system ID information, as well as System product information. Items on this window are non-configurable.

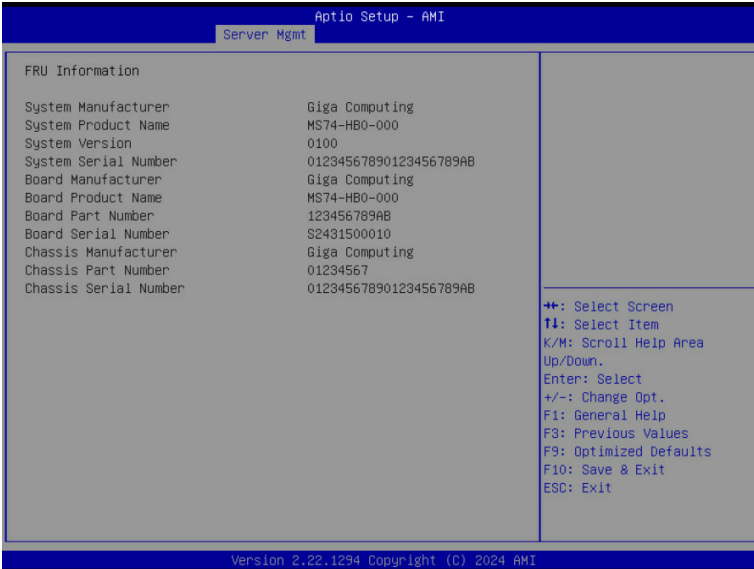

(Note) The model name will vary depends on the product you purchased

### 5-4-3 BMC VLAN Configuration

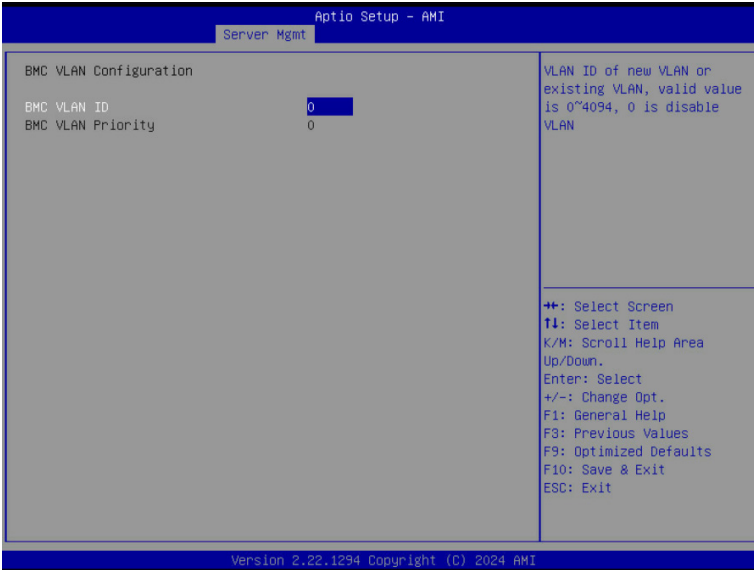

Parameter	Description
BMC VLAN Configuration	
BMC VLAN ID	Select to configure BMC VLAN ID. The valid range is from 0 to 4094. When set to 0, BMC VLAN ID will be disabled.
BMC VLAN Priority	Select to configure BMC VLAN Priority. The valid range is from 0 to 7. When BMC VLAN ID is set to 0, BMC VLAN Priority will not be selected.

## 5-4-4 BMC Network Configuration

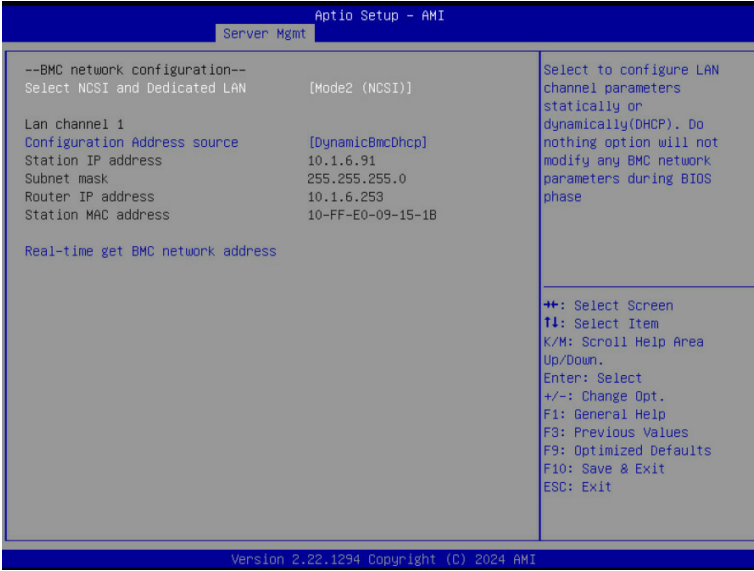

Parameter	Description
BMC network configuration	
Select NCSI and Dedicated LAN	Options available: Do Nothing, Model1(Dedicated), Model2(NCSI), Mode3(Failover). Default setting is <b>Do Nothing</b> .
Lan Channel 1	
Configuration Address source	Selects to configure LAN channel parameters statically or dynamically (DHCP). Options available: Unspecified, Static, DynamicBmcDhcp. Default setting is <b>DynamicBmcDhcp</b> .
Station IP address	Displays IP Address information.
Subnet mask	Displays Subnet Mask information. Please note that the IP address must be in three digitals, for example, 192.168.000.001.
Router IP address	Displays the Router IP Address information.
Station MAC address	Displays the MAC Address information.
Real-time get BMC network address	Press [Enter] will set LAN mode and Address source and then get IP, Subnet, Gateway and MAC address.

## 5-4-5 IPv6 BMC Network Configuration

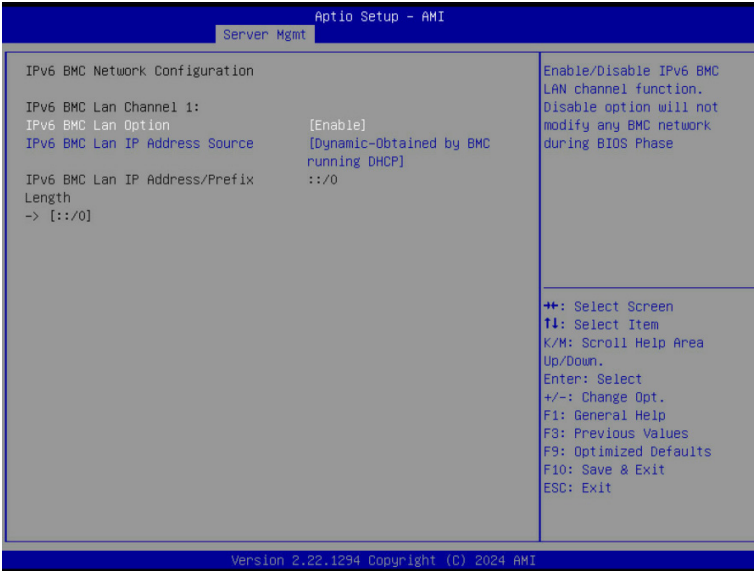

Parameter	Description
IPv6 BMC network configuration	
IPv6 BMC Lan Channel 1	
IPv6 BMC Lan Option	Enable/Disable IPv6 BMC LAN channel function. When this item is disabled, the system will not modify any BMC network during BIOS phase. Options available: Unspecified, Disable, Enable. Default setting is <b>Enable</b> .
IPv6 BMC Lan IP Address Source	Selects to configure LAN channel parameters statically or dynamically (by BIOS or BMC). Options available: Unspecified, Static, Dynamic-Obtained by BMC running DHCP. Default setting is <b>Dynamic-Obtained by BMC running DHCP</b> .
IPv6 BMC Lan IP Address/Prefix Length	Check if the IPv6 BMC LAN IP address matches those displayed on the screen.

## 5-5 Security Menu

The Security menu allows you to safeguard and protect the system from unauthorized use by setting up access passwords.

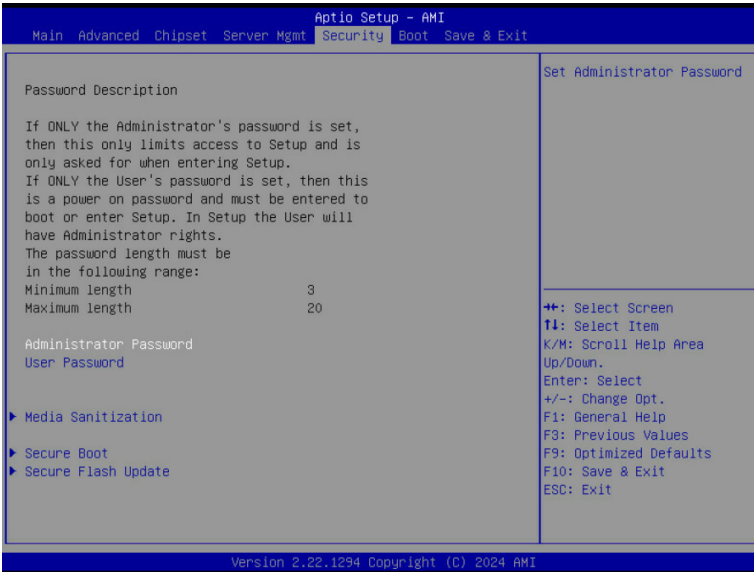

There are two types of passwords that you can set:

- Administrator Password  
Entering this password will allow the user to access and change all settings in the Setup Utility.
- User Password  
Entering this password will restrict a user's access to the Setup menus. To enable or disable this field, a Administrator Password must first be set. A user can only access and modify the System Time, System Date, and Set User Password fields.

Parameter	Description
Administrator Password	Press [Enter] to configure the administrator password.
User Password	Press [Enter] to configure the user password.
Secure Boot	Press [Enter] to configure advanced items.

## 5-5-1 Secure Boot

The Secure Boot feature is applicable if supported by your Operating System. If your Operating System is not supporting Secure Boot, the system will hang when starting the Operating System.

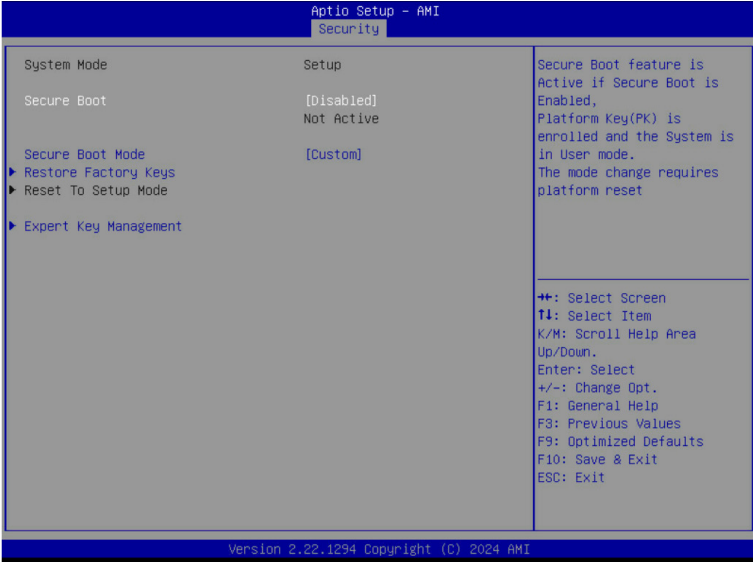

Parameter	Description
System Mode	Displays if the system is in User mode or Setup mode.
Secure Boot	Enable/ Disable the Secure Boot function. Options available: Enabled, Disabled. Default setting is <b>Disabled</b> .
Secure Boot Mode <sup>(Note)</sup>	Secure Boot requires all the applications that are running during the booting process to be pre-signed with valid digital certificates. This way, the system knows all files being loaded before the Operating System loads to the login screen have not been tampered with. When set to Standard, it will automatically load the Secure Boot keys form the BIOS databases. When set to Custom, you can customize the Secure Boot settings and manually load its keys from the BIOS database. Options available: Standard, Custom. Default setting is <b>Custom</b> .
Restore Factory Keys	Forces the system to user mode and installs factory default Secure Boot key database.
Reset To Setup Mode	Reset the system to Setup Mode.

(Note) Advanced items prompt when this item is set to **Custom**.



Parameter	Description
Key Management	<p data-bbox="335 156 665 180">Press [Enter] to configure advanced items.</p> <p data-bbox="335 185 936 235"><b>Please note that this item is configurable when Secure Boot Mode is set to Custom.</b></p> <ul style="list-style-type: none"> <li data-bbox="335 243 941 352">◆ Factory Key Provision <ul style="list-style-type: none"> <li data-bbox="367 266 941 321">– Allows to provision factory default Secure Boot keys when system is in Setup Mode.</li> <li data-bbox="367 326 904 352">– Options available: Enabled, Disabled. Default setting is <b>Disabled</b>.</li> </ul> </li> <li data-bbox="335 357 925 431">◆ Restore Factory Keys <ul style="list-style-type: none"> <li data-bbox="367 381 925 404">– Installs all factory default keys. It will force the system in User Mode.</li> <li data-bbox="367 409 606 431">– Options available: Yes, No.</li> </ul> </li> <li data-bbox="335 435 654 509">◆ Reset To Setup Mode <ul style="list-style-type: none"> <li data-bbox="367 459 654 482">– Reset the system to Setup Mode.</li> <li data-bbox="367 487 606 509">– Options available: Yes, No.</li> </ul> </li> <li data-bbox="335 514 899 595">◆ Enroll Efi Image <ul style="list-style-type: none"> <li data-bbox="367 537 899 595">– Press [Enter] to enroll SHA256 hash of the binary into Authorized Signature Database (db).</li> </ul> </li> <li data-bbox="335 600 936 682">◆ Export Secure Boot variables <ul style="list-style-type: none"> <li data-bbox="367 624 936 682">– Copy NVRAM content of Secure Boot variables to files in a root folder on a file system device.</li> </ul> </li> <li data-bbox="335 686 893 736">◆ Secure Boot variable <ul style="list-style-type: none"> <li data-bbox="367 710 893 736">– Displays the current status of the variables used for secure boot.</li> </ul> </li> <li data-bbox="335 741 803 846">◆ Platform Key (PK) <ul style="list-style-type: none"> <li data-bbox="367 765 803 788">– Displays the current status of the Platform Key (PK).</li> <li data-bbox="367 793 675 816">– Press [Enter] to configure a new PK.</li> <li data-bbox="367 821 601 846">– Options available: Update.</li> </ul> </li> <li data-bbox="335 851 941 987">◆ Key Exchange Keys (KEK) <ul style="list-style-type: none"> <li data-bbox="367 874 941 898">– Displays the current status of the Key Exchange Key Database (KEK).</li> <li data-bbox="367 903 904 956">– Press [Enter] to configure a new KEK or load additional KEK from storage devices.</li> <li data-bbox="367 961 670 987">– Options available: Update, Append.</li> </ul> </li> <li data-bbox="335 992 941 1128">◆ Authorized Signatures (DB) <ul style="list-style-type: none"> <li data-bbox="367 1016 904 1039">– Displays the current status of the Authorized Signature Database.</li> <li data-bbox="367 1044 941 1097">– Press [Enter] to configure a new DB or load additional DB from storage devices.</li> <li data-bbox="367 1102 670 1128">– Options available: Update, Append.</li> </ul> </li> <li data-bbox="335 1133 899 1270">◆ Forbidden Signatures (DBX) <ul style="list-style-type: none"> <li data-bbox="367 1157 899 1180">– Displays the current status of the Forbidden Signature Database.</li> <li data-bbox="367 1185 893 1238">– Press [Enter] to configure a new dbx or load additional dbx from storage devices.</li> <li data-bbox="367 1243 670 1270">– Options available: Update, Append.</li> </ul> </li> </ul>

Parameter	Description
Key Management (continued)	<ul style="list-style-type: none"> <li>◆ Authorized TimeStamps (DBT) <ul style="list-style-type: none"> <li>– Displays the current status of the Authorized TimeStamps Database.</li> <li>– Press [Enter] to configure a new DBT or load additional DBT from storage devices.</li> <li>– Options available: Update, Append.</li> </ul> </li> <li>◆ OsRecovery Signatures <ul style="list-style-type: none"> <li>– Displays the current status of the OsRecovery Signature Database.</li> <li>– Press [Enter] to configure a new OsRecovery Signature or load additional OsRecovery Signature from storage devices.</li> <li>– Options available: Update, Append.</li> </ul> </li> </ul>

## 5-6 Boot Menu

The Boot menu allows you to set the drive priority during system boot-up. BIOS setup will display an error message if the legacy drive(s) specified is not bootable.

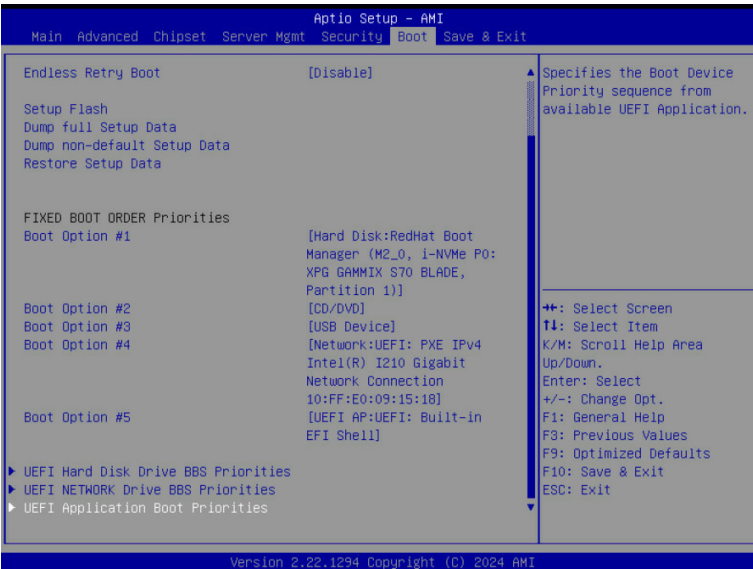
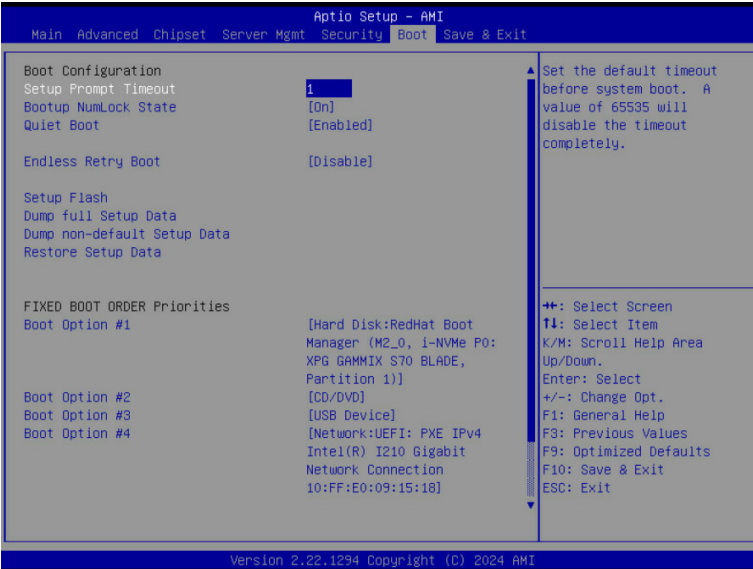

Parameter	Description
Boot Configuration	
Setup Prompt Timeout	Number of seconds to wait for setup activation key. 65535 (0xFFFF) means indefinite waiting. Press the numeric keys to input the desired values.
Bootup NumLock State	Enable/Disable the Bootup NumLock function. Options available: On, Off. Default setting is <b>On</b> .
Quiet Boot	Enable/Disable showing the logo during POST. Options available: Enabled, Disabled. Default setting is <b>Enabled</b> .
Endless Retry Boot	Options available: Disable, Enable. Default setting is <b>Disable</b> .
Setup Flash	Press [Enter] to run setup flash.
Dump full Setup Data	Press [Enter] to dump full setup data to file.
Dump non-default Setup Data	Press [Enter] to dump non-default setup data to file.
Restore Setup Data	Press [Enter] to restore setup data from file.

Parameter	Description
FIXED BOOT ORDER Priorities	
Boot Option #1 / #2 / #3 / #4 / #5	Press [Enter] to configure the boot order priority. By default, the server searches for boot devices in the following sequence: <ol style="list-style-type: none"> <li>1. Hard drive.</li> <li>2. CD-COM/DVD drive.</li> <li>3. USB device.</li> <li>4. Network.</li> <li>5. UEFI.</li> </ol>
UEFI Application Boot Priorities	Press [Enter] to configure the boot priority.

# 5-7 Save & Exit Menu

The Save & Exit menu displays the various options to quit from the BIOS setup. Highlight any of the exit options then press <Enter>.

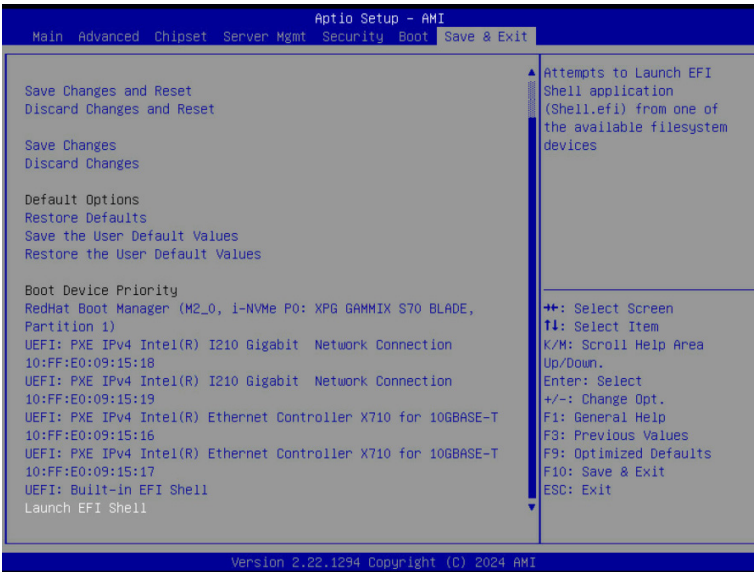
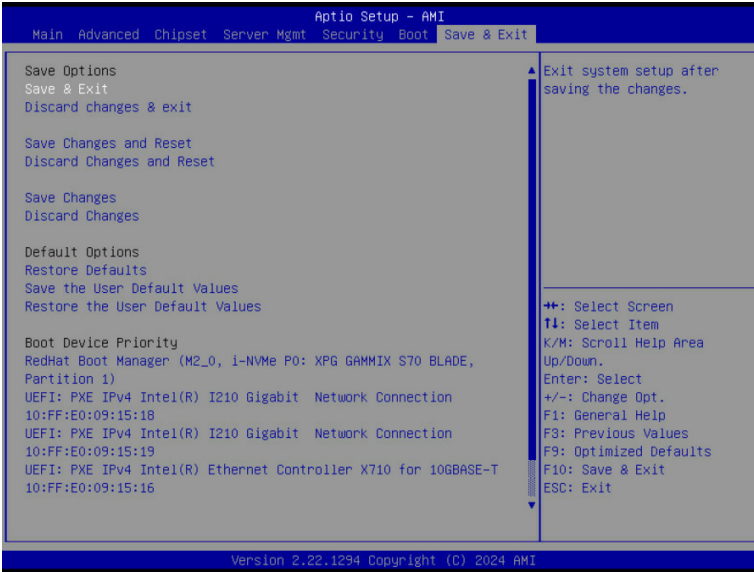

Parameter	Description
Save Options	
Save and Exit	Saves changes made and closes the BIOS setup. Options available: Yes, No.
Discard changes and exit	Discards changes made and exits the BIOS setup. Options available: Yes, No.
Save Changes and Reset	Restarts the system after saving the changes made. Options available: Yes, No.
Discard Changes and Reset	Restarts the system without saving any changes. Options available: Yes, No.
Save Changes	Saves changes done so far to any of the setup options. Options available: Yes, No.
Discard Changes	Discards changes made and closes the BIOS setup. Options available: Yes, No.
Default Options	

Parameter	Description
Restore Defaults	Loads the default settings for all BIOS setup parameters. Setup Defaults are quite demanding in terms of resources consumption. If you are using low-speed memory chips or other kinds of low-performance components and you choose to load these settings, the system might not function properly. Options available: Yes, No.
Save the User Default Values	Saves the changes made as the user default settings. Options available: Yes, No.
Restore the User Default Values	Loads the user default settings for all BIOS setup parameters. Options available: Yes, No.
Boot Device Priority	Press [Enter] to configure the device as the boot-up drive.
Launch EFI Shell	Attempts to Launch EFI Shell application (Shell.efi) from one of the available file system devices.

# 5-8 BIOS Recovery

The system has an embedded recovery technique. In the event that the BIOS becomes corrupt the boot block can be used to restore the BIOS to a working state. To restore your BIOS, please follow the instructions listed below:

Recovery Instruction:

1. Copy the XXX.rom to USB diskette.
2. Setting BIOS Recovery jump to enabled status.
3. Boot into BIOS recovery.
4. Run Proceed with flash update.
5. BIOS updated.

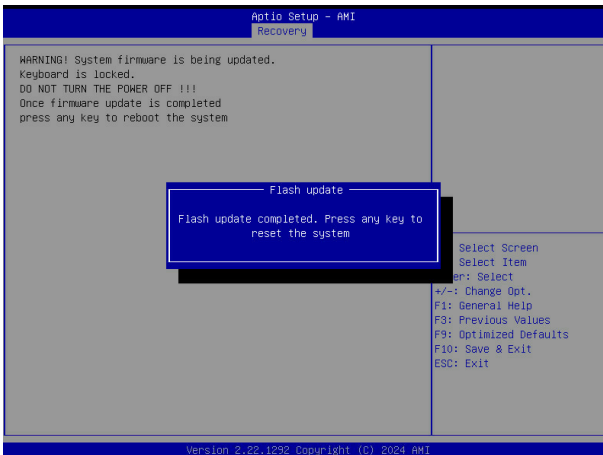

## 5-9 BIOS POST Beep code (AMI standard)

### 5-9-1 PEI Beep Codes

# of Beeps	Description
1	Memory not Installed.
1	Memory was installed twice (InstallPeiMemory routine in PEI Core called twice)
2	Recovery started
3	DXE IPL was not found
3	DXE Core Firmware Volume was not found
4	Recovery failed
4	S3 Resume failed
7	Reset PPI is not available

### 5-9-2 DXE Beep Codes

# of Beeps	Description
1	Invalid password
4	Some of the Architectural Protocols are not available
5	No Console Output Devices are found
5	No Console Input Devices are found
6	Flash update is failed
7	Reset protocol is not available
8	Platform PCI resource requirements cannot be met