

GIGABYTE™

SabrePro 15

USER'S MANUAL

使用手冊

English

繁體中文

한국어

BC

V1.0

Regulatory Notices

CB :

- Only use batteries designed for this computer. The wrong battery type may explode, leak or damage the computer.
- Do not remove any batteries from the computer while it is powered on.
- Do not continue to use a battery that has been dropped, or that appears damaged (e.g. bent or twisted) in any way. Even if the computer continues to work with a damaged battery in place, it may cause circuit damage, which may possibly result in fire.
- Recharge the batteries using the Notebook's system. Incorrect recharging may make the battery explode.
- Do not try to repair a battery pack. Refer any battery pack repair or replacement to your service representative or qualified service personnel.
- Keep children away from, and promptly dispose of a damaged battery. Always dispose of batteries carefully. Batteries may explode or leak if exposed to fire, or improperly handled or discarded.
- Keep the battery away from metal appliances.
- Affix tape to the battery contacts before disposing of the battery.
- Do not touch the battery contacts with your hands or metal objects.



CAUTION: RISK OF EXPLOSION IF BATTERY IS REPLACED BY AN INCORRECT TYPE.
DISPOSE OF USED BATTERIES ACCORDING TO THE INSTRUCTIONS

RF Exposure :

This equipment must be installed and operated in accordance with provided instructions and must not be co-located or operating in conjunction with any other antenna or transmitter. End-users and installers must be provided with antenna installation instructions and transmitter operating conditions for satisfying RF exposure compliance.

BSMI Notice (Taiwan Only)



- The symbol above must be attached to the product indicating compliance with the BSMI standard.
- Most Notebook are classified by the Bureau of Standards, Meteorology and Inspection (BSMI) as Class B information technology equipment (ITE).
- Caution: Suggest to operate under 35°C

Regulatory Notices

CB :

- Only use batteries designed for this computer. The wrong battery type may explode, leak or damage the computer.
- Do not remove any batteries from the computer while it is powered on.
- Do not continue to use a battery that has been dropped, or that appears damaged (e.g. bent or twisted) in any way. Even if the computer continues to work with a damaged battery in place, it may cause circuit damage, which may possibly result in fire.
- Recharge the batteries using the Notebook's system. Incorrect recharging may make the battery explode.
- Do not try to repair a battery pack. Refer any battery pack repair or replacement to your service representative or qualified service personnel.
- Keep children away from, and promptly dispose of a damaged battery. Always dispose of batteries carefully. Batteries may explode or leak if exposed to fire, or improperly handled or discarded.
- Keep the battery away from metal appliances.
- Affix tape to the battery contacts before disposing of the battery.
- Do not touch the battery contacts with your hands or metal objects.



CAUTION: RISK OF EXPLOSION IF BATTERY IS REPLACED BY AN INCORRECT TYPE.
DISPOSE OF USED BATTERIES ACCORDING TO THE INSTRUCTIONS

RF Exposure :

This equipment must be installed and operated in accordance with provided instructions and must not be co-located or operating in conjunction with any other antenna or transmitter. End-users and installers must be provided with antenna installation instructions and transmitter operating conditions for satisfying RF exposure compliance.

BSMI Notice (Taiwan Only)



- The symbol above must be attached to the product indicating compliance with the BSMI standard.
- Most Notebook are classified by the Bureau of Standards, Meteorology and Inspection (BSMI) as Class B information technology equipment (ITE).
- Caution: Suggest to operate under 35°C

Battery Maintenance Guidance

Before you use your Notebook on the road, you will have to charge the battery pack. The battery pack begins to charge as soon as the Notebook is connected to external power using the power adapter. Fully charge the battery pack before using it for the first time. A new battery pack must completely charge before the Notebook is disconnected from external power. It takes a few hours to fully charge the battery when the Notebook is turned OFF. Please note the battery stops charging if the temperature is too high or the battery voltage is too high.



NOTE: Do not leave the battery pack discharged. The battery pack will discharge over time. If not using a battery pack, it must continued to be charged every three month to extend recovery capacity or else it may fail to charge in the future. Rechargeable Li-Ion batteries require routine maintenance and care in their use and handling. Read through below instruction and your Notebook will achieve the maximum battery life span.

Battery Maintenance :

- Do not leave batteries unused for extended periods of time, either in the Notebook or in storage. When a battery has been unused for 3months, check the charge status and charge or dispose of the battery as appropriate.
- The typical estimated life of a Rechargeable Li-Ion battery is about two to three years or 300 to 500 charge cycles, whichever occurs first. One charge cycle is a period of use from fully charged, to fully discharged, and fully recharged again. Use a two to three year life expectancy for batteries that do not run through complete charge cycles.
- Rechargeable Li-Ion batteries have a limited life and will gradually lose their capacity to hold a charge. This loss of capacity is irreversible. As the battery loses capacity, the length of time it will power the Notebook decreases.
- The run time of your battery will vary depending on the product's configuration and the applications that you run. Routinely check the battery's charge status.
- Battery terminals must avoid contact with any metallic substance. For preventing shortage, avoid silver coins, tinsels and any other metallic substances to contact the + and - terminals of the battery. For example, It might happen by inserting the batteries to a coat pocket or a leather handbag with some metallic substances mounted on it (metal buttons or zippers). There is high possibility of causing short circuits and connection damage of the battery.
- Consider replacing the battery with a new one if you note either of the following conditions:
 - (1) The battery run time drops below about 80% of the original run time.
 - (2) The battery charge time increases significantly.
 - (3) If a battery is stored or otherwise unused for an extended period, be sure to follow the storage instructions. If you do not follow the instructions, and the battery has no charge remaining when you check it, consider it to be damaged. Do not attempt to recharge it or to use it. Replace it with a new battery.

Charging :

The Rechargeable Li-Ion battery is recharged internally using the AC adapter. To recharge the battery, make sure the battery is installed and the Notebook is connected to the AC adapter. The charge times will be significantly longer if your Notebook is in use while the battery is charging. If you want to charge the battery more quickly, put your computer into Suspend mode or turn it off while the adapter is charging the battery. Please always follow the charging instructions provided with your Notebook.

** If you happen to leave your battery pack to go through an extended period of self-discharge, say more than three months, the battery voltage level will become too low and needs to be Pre-Charged (to bring the battery voltage level high enough) before it automatically resumes its normal Fast Charge. Pre-Charge may take 30 minutes. Fast Charge usually takes 2~3 hours.*

Low Battery State :

When the battery level is low, a notification message appears. If you do not respond to the low battery message, the battery continues to discharge until it is too low to operate. When this happens, your Notebook goes into Suspend mode. There is no guarantee your data will be saved once the Notebook reaches this point.



CAUTION: To protect your Notebook from damage, use only the power adapter that came with it because each power adapter has its own power output rating.

Once your Notebook goes into suspend mode as a result of a dead battery, you will be unable to resume operation until you provide a source of power either from an adapter or a charged battery. Once you have provided power, you can press the Suspend/ Resume button to resume operation. In Suspend mode, your data is maintained for some time, but if a power source is not provided promptly, the power indicator stops flashing and then goes out, in which case you have lost the data that was not saved. Once you provide power, you can continue to use your computer while an adapter charges the battery.

Storage :

- Charge or discharge the battery to approximately 50% of capacity before storage.
- Charge the battery to approximately 50% of capacity at least once every three months.
- Remove the battery and store it separately from the Notebook.
- Store the battery at temperatures between 5°C and 20°C (41°F and 68°F).



CAUTION: The battery self-discharges during storage. Higher temperatures (above 20°C or 68°F) reduce the battery storage life.

Handling Precautions :

- Do not disassemble, crush, or puncture a battery.
- Do not short the external contacts on a battery.
- Do not dispose of a battery in fire or water.
- Do not expose a battery to temperatures above 60°C (140°F).
- Keep the battery away from children.
- Avoid exposing the battery to excessive shock or vibration.
- Do not use a damaged battery.
- If a battery pack has leaking fluids, do not touch any fluids. Dispose of a leaking battery pack (see Disposal and Recycling section).In case of eye contact with fluid, do not rub eyes. Immediately flush eyes thoroughly with water for at least 15 minutes, lifting upper and lower lids, until no evidence of the fluid remains. Seek medical attention.

Transportation :

Always check all applicable local, national, and international regulations before transporting a Rechargeable Li-Ion battery. Transporting an end-of-life, damaged, or recalled battery may, in certain cases, be specifically limited or prohibited.

Disposal and Recycling :

Rechargeable Li-Ion batteries are subject to disposal and recycling regulations that vary by country and region. Always check and follow your applicable regulations before disposing of any battery. Contact your local battery recycling organization. Many countries prohibit the disposal of waste electronic equipment in standard waste receptacles. Place only discharged batteries in a battery collection container. Use electrical tape or other approved covering over the battery connection points to prevent short circuits.



The symbol of the crossed out wheeled bin indicates that the product (electrical and electronic equipment) should not be placed in municipal waste. Please check local regulations for disposal of electronic products.

注意事項

- 請僅使用專為本電腦所設計的電池。不正確的電池類型可能會造成爆炸、漏電或損壞電腦。
- 請勿在開啟電源時取出電腦的電池。
- 請勿繼續使用已掉落的電池，或是出現任何損壞狀況(例如彎曲或扭曲)的電池。即使電腦能夠以受損的電池繼續運作，也可能造成電路損壞，並造成火災。
- 請使用筆記型電腦的系統為電池充電。不正確的充電方式可能會導致電池爆炸。
- 請勿嘗試自行修理電池。請交由維修代表或合格維修人員進行任何電池修理或更換。
- 請勿讓兒童接觸受損的電池，應立即加以丟棄。請務必謹慎處理電池。若曝露在火焰中、不當處理或棄置，可能會造成電池爆炸或漏電。
- 請將電池遠離金屬設備。
- 在棄置電池之前，請在電池接觸點上黏貼膠帶。
- 請勿以雙手或金屬物體碰觸電池接觸點。

射頻曝露值：

本設備必須依據所提供的指示安裝及操作，且不得與任何其他天線或發射機並置或共同操作。必須對一般使用者及安裝人員提供天線安裝指示及發射機操作條件，以滿足射頻曝露值的法規要求。

※ 減少電磁波影響，請妥善使用。

本機限在不干擾合法電台與不受被干擾保障條件下於室內使用。

依據低功率電波輻射性電機管理辦法第十二條：「經型式認證合格之低功率射頻電機，非經許可，公司、商號或使用者均不得擅自變更頻率、加大功率或變更原設計之特性及功能。」第十四條：「低功率射頻電機之使用不得影響飛航安全及干擾合法通信；經發現有干擾現象時，應立即停用，並改善至無干擾時方得繼續使用。前項合法通信，指依電信法規定作業之無線電通信。低功率射頻電機須忍受合法通信或工業、科學及醫療用電波輻射性電機設備之干擾。」

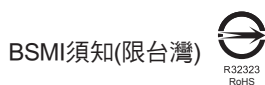

- 產品必須貼上以上標誌，代表符合BSMI標準的規定。
- 經濟部標準檢驗局(BSMI)將大部分的筆記型電腦歸類為B級資訊技術設備(ITE)。
- 注意：最高操作溫度35°C

電池保存須知

鋰離子充電電池在使用和處理時，需要定期進行保養。請仔細閱讀並遵循以下說明，以安全地使用鋰電池，讓電池擁有最長的使用壽命。

電池保養：

- 無論是置於筆記型電腦中或存放處，請勿讓電池長時間放置不用。電池若超過 3 個月未使用，請檢查充電狀態，決定是否進行充電或棄置電池。
- 鋰電池一般預估使用壽命為2到3年，或是300到500次的充電週期，以先發生者為準。一次充電週期是指從完全充電到完全放電，然後再次完全充電的一段時間。未經過完整充電週期的電池，使用壽命預計為2到3年。
- 鋰離子充電電池的使用壽命有限，充電容量將逐漸減少，量無法回復。當電池的充電容量降低，能為筆記型電腦供電的時間也會變短。
- 鋰電池在未使用或處於存放狀態時，會持續緩慢放電(自動放電)。請定期檢查電池的充電狀態。
- 請勿將電池短路。以錢幣、金屬片等金屬物品直接連接電池的正極(+)及負極(-)終端(外觀類似電池上的金屬條)時，可能會不小心引發短路。例如，當您將備用電池放在口袋或皮包內可能發生此狀況。將終端短路可能會損壞電池。
- 若您注意到下列情況之一，請考慮更換新電池：
 - (1) 電池運作時間，縮短到少於原始運作時間的80%。
 - (2) 電池充電時間大幅延長。

- (3) 若電池長時間存放或未使用，請務必遵循本文件提供的存放操作說明。若您未遵循本說明，而在查看電池時發現仍未充電，則該電池應已損壞。請勿試圖為該電池充電或使用電池。請更換新電池。

充電：

電腦內的鋰電池可經由交流電變壓器重新充電。要將鋰電池重新充電，請先確定已妥當裝入電池，而且電腦以連接交流電源。鋰電池並沒有「記憶功能」，因此在重新充電前，並不需要將鋰電池完全放電。電池充電期間，如果正在使用筆記型電腦，充電時間會明顯比較長。如果縮短充電時間，請在充電時，將電腦切換為暫停模式或關機。

* 若電池閒置自行放電超過三個月，則電池的電壓位準會變過低，而在電池自動恢復成正常充電前，需要預先充電(提高到足夠的電池電壓位準)，預先充電可能需花費30分鐘，快速充電通常需花費2-3小時。

低電量狀態：

電池電量低時，會出現通知訊息。如果您不回應電池電量不足的訊息，電池將持續放電，直到電量過低而無法操作為止。發生此種情況時，您的筆記型電腦將進入閒置模式，當電腦達到此情況時，並不保證您的資料將被儲存。



注意:為保護您的筆記型電腦免於受損，請務必使用隨附的變壓器，因為每一個變壓器都有規定的電源輸出率。

一旦因為電池沒電而使電腦進入暫停模式，除非由變壓器或另一個充好電的電池提供電源，否則電腦無法恢復作業。重新提供電源後，就可以按暫停 / 開機按鈕來恢復作業。待機模式時，您電腦內的資料都會暫時保留，但如果等到電源指示燈停止閃爍，終究熄滅，您還沒有接上外接電源，那所有未存檔的資料都會消失。提供電源後就可以一邊使用電腦，一邊讓電池充電。

電池存放：

- 存放前請將電池充電或放電至約容量的50%。
- 至少每3個月將電池充電至約容量的50%。
- 從產品中取出電池，並另行存放。
- 將電池存放於5° C到20° C (41° F到68° F) 的溫度中。



注意：電池在存放時會自動放電。高溫 (20°C 或68°F以上) 會縮短電池存放壽命。

處理注意事項：

- 請勿拆解、壓碎或穿刺電池。
- 請勿讓電池外露接點短路。
- 請勿將電池棄置於火中或水中。
- 請勿讓電池暴露在60° C (140° F) 以上的溫度中。
- 請將電池置於兒童無法觸及之處。
- 請勿讓電池承受過度衝擊或震動。
- 請勿使用損壞的電池。
- 若電池組有漏液現象，請勿觸碰任何液體。請棄置漏液的電池組。
- 若眼睛接觸到電池漏液，請勿搓揉眼睛。請立即掀開上下眼皮，水徹底清洗眼睛至少15分鐘，直到沒有任何電池漏液殘留為止，並請立即就醫。

棄置與回收：

鋰電池受到不同國家和地區的棄置與回收法規規範。在棄置任何電池前，請務必查看並遵守您當地適用的法規或是聯絡您當地的電池回收組織。許多國家禁止將廢棄的電子設備，棄置於一般的垃圾桶內。只將耗盡電力的電池置入電池回收桶。使用絕緣膠帶或其他核准的覆蓋物，蓋住電池的接點，以防止短路。



請勿將本產品當作一般垃圾丟棄。本產品零組件設計為可回收利用。這個打X的垃圾桶標誌表示本產品(電器與電子設備)不應視為一般垃圾丟棄，請依照您所在地區有關廢棄電子產品的處理方式處理。



請勿將電池當作一般垃圾丟棄。這個標誌表示電池不應視為一般垃圾丟棄。

單元Unit	限用物質及其化學符號 Restricted substances and its chemical symbols					
	鉛Lead (Pb)	汞Mercury (Hg)	鎘Cadmium (Cd)	六價鉻 Hexavalent chromium (Cr ⁺⁶)	多溴聯苯 Polybrominated biphenyls (PBB)	多溴二苯醚 Polybrominated diphenyl ethers (PBDE)
外殼	○	○	○	○	○	○
面板	○	○	○	○	○	○
主機板	○	○	○	○	○	○
記憶體	○	○	○	○	○	○
硬碟	○	○	○	○	○	○
網路卡	○	○	○	○	○	○
喇叭	○	○	○	○	○	○
交換式電源供應器	○	○	○	○	○	○
配件 (鍵盤、電源線、排線、傳輸線等)	○	○	○	○	○	○
其它固定組件 (螺絲、夾具、卡榫)	-	○	○	○	○	○

備考1. “超出0.1wt%”及“超出0.01wt%”係指限用物質之百分比含量超出百分比含量基準值。
Note 1: “Exceeding 0.1 wt %” and “exceeding 0.01 wt %” indicate that the percentage content of the restricted substance exceeds the reference percentage value of presence condition.

備考2. “○”係指該項限用物質之百分比含量未超出百分比含量基準值。
Note 2: “○” indicates that the percentage content of the restricted substance does not exceed the percentage of reference value of presence.

備考3. “-”係指該項限用物質為排除項目。
Note 3: The “-” indicates that the restricted substance corresponds to the exemption

B급 기기(가정용 방송통신기기):

이 기기는 가정용 (B 급) 으로 전자파적합등록을 한 기기로서 주로 가정에서 사용하는것을 목적으로 하며, 모든 지역에서 사용할 수 있습니다.



<경고> 발열, 화재, 폭발 등의 위험을 수반할 수 있으니 다음 사항을 지켜주시기 바랍니다.

- (1) 육안으로 식별이 가능할 정도의 부풀음이 발생된 전지는 위험할 수 있으므로 제조자 또는 판매자로 즉시 문의 하십시오
- (2) 지정된 정품 충전기만을 사용 하십시오
- (3) 화기에 가까이 하지 마십시오 (전자레인지에 넣지 마십시오)
- (4) 여름철 자동차 내부에 방치 하지 마십시오
- (5) 찜질방 등 고온 다습한 곳에서 보관, 사용하지 마십시오
- (6) 이불, 전기장판, 카펫 위에 올려 놓고 잠시간 사용하지 마십시오
- (7) 전원을 켜 상태로 밀폐된 공간에 장시간 보관하지 마십시오
- (8) 전지 단자에 목걸이, 동전, 열쇠, 시계 등 금속 제품이 닿지 않도록 주의 하십시오
- (9) 휴대 기기, 제조업체가 보증한 리튬 2 차 전지를 사용 하십시오
- (10) 분해, 압착, 관통 등의 행위를 하지 마십시오
- (11) 높은 곳에서 떨어뜨리는 등 비정상적 충격을 주지 마십시오
- (12) 60 도 이상의 고온에 노출하지 마십시오
- (13) 습기에 접촉되지 않도록 하십시오

Congratulations on your purchase of the GIGABYTE Notebook.

This manual will help you to get started with setting up your notebook. The final product configuration depends on the model at the point of your purchase. GIGABYTE reserves the right to amend without prior notice. For more detailed information, please visit our website at www.gigabyte.com

Using GIGABYTE Notebook for the First Time

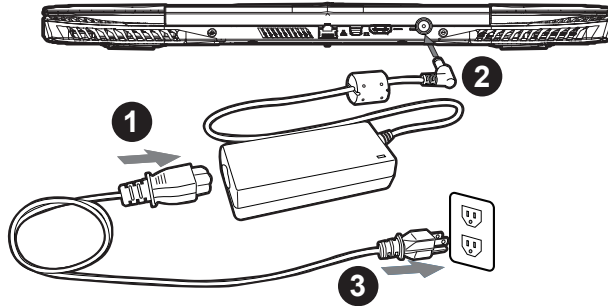

- 1 Connect the power cord to the AC adapter.
- 2 Connect the AC adapter to the DC-in jack on the rear side of the notebook.
- 3 Connect the power cord to the power outlet.

IMPORTANT!

- Ensure that your Notebook PC is connected to a grounded power adapter before turning it on for the first time.
- When using your Notebook PC on power adapter mode, the socket outlet must be near to the unit and easily accessible.
- Locate the input/output rating label on your Notebook PC and ensure that it matches the input/output rating information on your power adapter. Some Notebook PC models may have multiple rating output currents based on the available SKU.
- Power adapter information: - Input voltage: 100-240Vac - Input frequency: 50-60Hz - Rating output voltage: 19.5V,9.23A

Switching on the Power :

After you turn on the Notebook for the very first time, do not turn it off until the operating system has been configured. Please note that the volume for the audio will not function until Windows® Setup has completed.

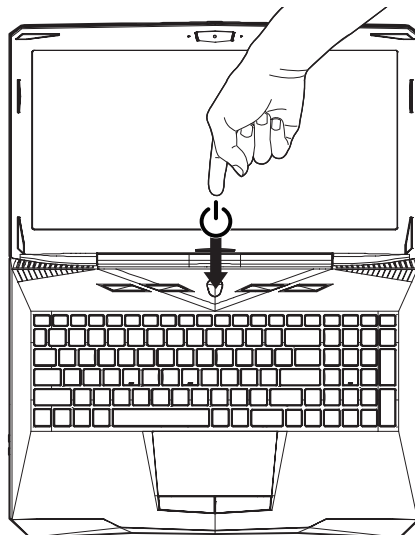

Booting Up the Notebook for the First Time

Depending on your configuration, the Microsoft® Windows® Boot Screen will be the first screen that you will see as the notebook starts up. Follow the on-screen prompts and instructions and enter your personal information to complete the setup of the Windows® Operating System.

Your GIGABYTE Notebook Tour

Top View & Front View

- 1 Webcam
- 2 Webcam Indicators
- 3 Microphone
- 4 Power Button
- 5 TouchPad

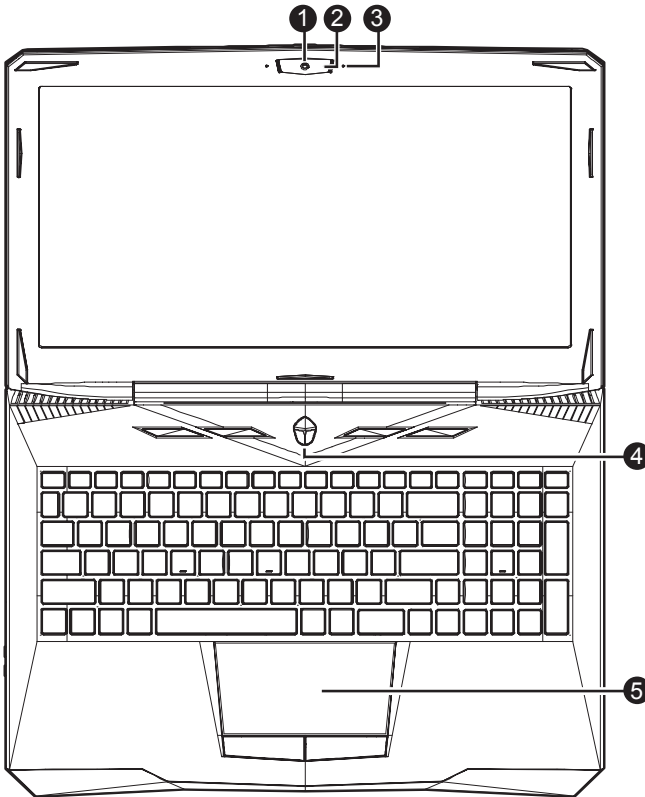

Left View

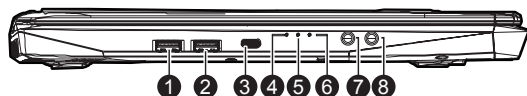

- 1 USB 3.1 Gen.1 Port
- 2 USB 3.1 Gen.1 Port
- 3 USB 3.1 Gen.2 Port (Type-C)
- 4 Battery Charge Indicator
- 5 HDD Status LED
- 6 Wireless Lan Status LED
- 7 Microphone Input Jack
- 8 Headphone Output Jack

Right View

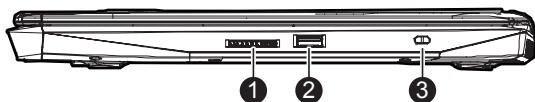

- 1 SD Card Reader
- 2 USB 3.1 Gen.1 Port
- 3 Kensington Lock Slot

Rear View

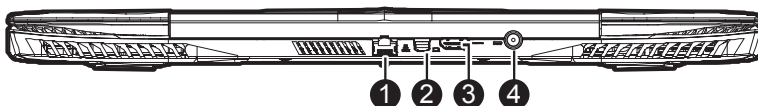

- 1 Ethernet Port
- 2 MiniDisplayPort
- 3 HDMI Port
- 4 DC-in Jack





























Warning:

DO NOT remove the built-in lithium battery. For any service needs, please contact your local GIGABYTE Authorized Service Center.

- Do not install the Notebook PC on a slant or a place prone to vibrations, or avoid using the Notebook PC in that location for a long time. This increases the risk that a malfunction or damage to the product will occur.
- Do not store and use Notebook PC in direct sunlight or the location where temperatures exceed 112°F (45°C) such as inside a vehicle. There is a danger of Lithium-ion battery expansion and aging.
- Do not use the Notebook PC in a badly ventilated location such as on bedding, on a pillow or cushion, etc, and do not use it in a location such as room with floor heating as it may cause the computer to overheat. Take care that the Notebook PC vents (on the side or the bottom) are not blocked especially in these environments. If the vents are blocked, it may be dangerous and cause the Notebook PC to overheat.

Hotkeys

The computer employs hotkeys or key combinations to access most of the computer's controls like screen brightness and volume output. To activate hotkeys, press and hold the <Fn> key before pressing the other key in the hotkey combination.

Function	Function	Description
Fn+!	 	Fan Switch Turn fans to maximum/normal model
Fn+F2	 	Airplane Mode Enable/disable the Airplane Mode function.
Fn+F4	 	Power Management Switch various power modes
Fn+F5	 	Brightness Down Decrease the screen brightness.
Fn+F6	 	Brightness Up Increase the screen brightness.
Fn+F7	 	Screen Display Toggle Turn the screen display on and off.
Fn+F8	 	Display Toggle "Switch display output between the display screen, external monitor (if connected) and both."
Fn+F9	 	Touchpad Toggle Turn the internal touchpad on and off.
Fn+F10	 	Speaker Toggle Turn the speaker on and off.
Fn+F11	 	Volume Down Decrease the sound volume.
Fn+F12	 	Volume Up Increase the sound volume.
Fn+Z	 	Keyboard Backlight Down Decrease the keyboard backlight brightness
Fn+X	 	Keyboard Backlight Up Increase the keyboard backlight brightness

Control Center

Control Center gives quick access to power management, macro functions and keyboard lighting effects provides user a faster and better experience when customization is needed

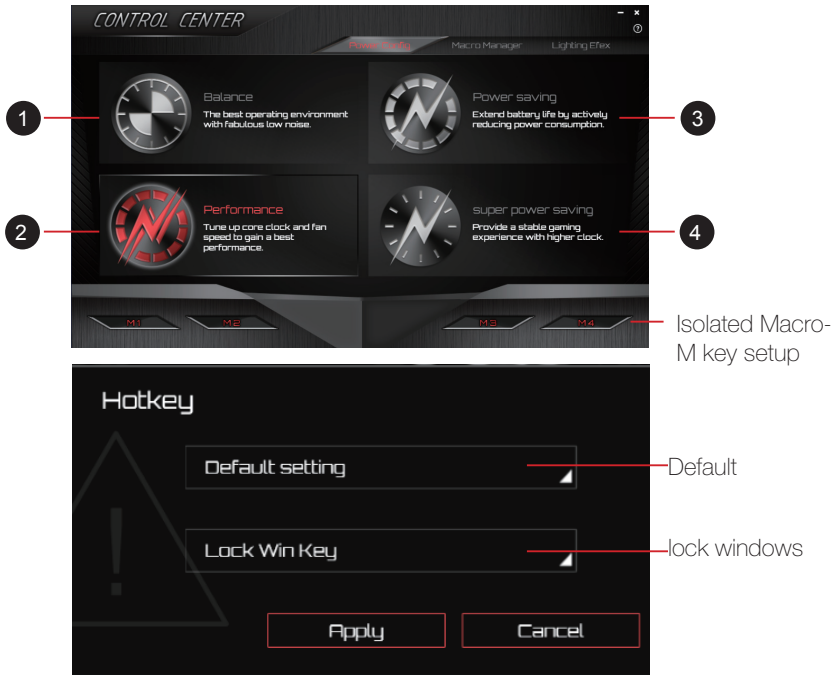

Power Config

- 1 Balance
- 2 Performance
- 3 Power saving
- 4 Super power saving

Isolated Macro-M key setup

- 1 Choose each macro key from M1 to M4, you'll see the hotkey setup windows
- 2 Five options below and choose each of them.
 - (1) Default setting: to lock Windows
 - (2) Power config: to choose each power con
 - (3) Macro profile: to quickly start a customized macro prof
 - (4) Light profile: to choose different keyboard light prof
 - (5) Turn off hotkey: to make the macro key without any functio
- 3 Click "Apply" and macro key has been setted up.

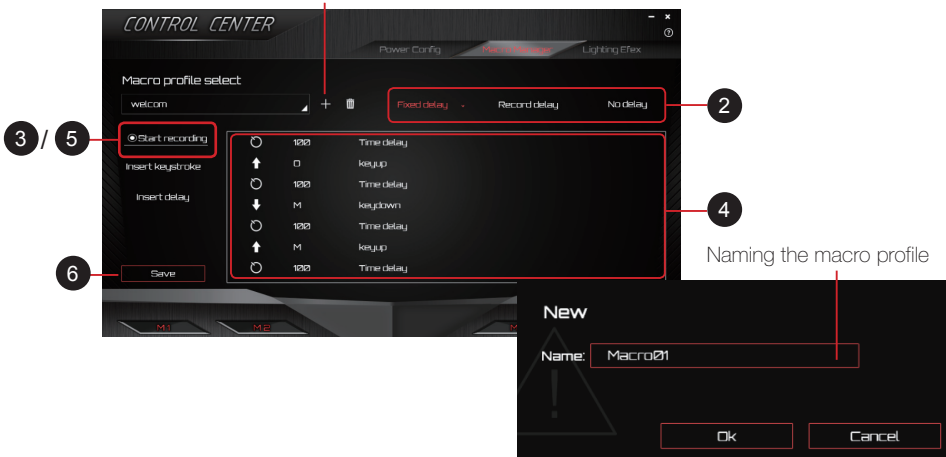

Macro Manager

- 1 Click "+" to create a new profile and naming the profile.
- 2 If you would add the delay timed, you can choose fixed delay or record delay; if you won't, please choose No delay.
- 3 Click "Start recording" and it will turn in read color.
- 4 To type your macro profile.
- 5 To click "Start recording" again to stop recording and it will turn in white color.
- 6 Click "Save" and store the macro profile.

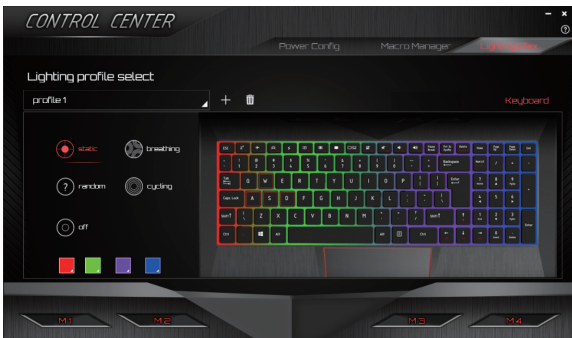

Lighting Efex

- 1 Click "+" to create a new profile and naming the profile.
- 2 There're five effects below for choosing: static, random, off, breathing & cycling.

Smart USB Backup Guide

⚠ WARNING

- You can backup original recovery image through this application in case of losing by device damage.
- You can backup original recovery image to USB disk and restore the system if any storage system replacement with the recovery USB disk.
- Before you restore the system through the recovery USB disk, please make sure that you have already made the backup of your data.
- Please DO NOT shut down or un-plug the system when performing backup through recovery USB disk.

1



- Please plug in the USB Flash Drive which is at least 32GB in capacity to make the original image (backup the data in USB first. All data will be eliminated during the creation of recovery USB Flash Drive)

2



- Insert the driver disk to your optical drive and run the install of "Smart USB Backup" (for none-ODD model, please use USB ODD device or download from <http://www.gigabyte.com>)

3



- Run the "Smart USB Backup" after finishing the install.

4



- Select your USB disk from the drop-down list and start to create the recovery USB disk.

5

- The window will pop out when the creation of recovery disk is done.
- Please press ESC on starting the system when you need to restore the system. Select "boot from recovery USB disk" and the system will be restored.
- The time needed for restore will be around 30 mins(time needed may vary by USB disk model) .

Recovery Guide

System Recovery (Restore your laptop operating system)

When something is going wrong with the laptop operating system, the storage of the laptop has a hidden partition containing a full back up image of the operating system that can be used to restore the system to factory default settings.



Note

- If the storage has been switched or the partition deleted, the recovery option will no longer be available and a recovery service will be needed.
- The recovery function is only available on devices with O/S preinstalled. Devices with DOS do not have the recovery function.

Launch System Recovery

The system recovery feature is preinstalled before the laptop is shipped from the factory. The option menu allows you to launch the Windows recovery tool to reinstall the operating system to factory default.

The brief introduction below will show you how to start the recovery tool and restore your system.



All ready to go

Make sure your PC is plugged in. This will take a few minutes.

Windows 10 Recovery Guide

1

Turn off and restart the laptop.

2



During the laptop turn on process, press and hold F9 key to launch the tool.

3



Choose "Troubleshoot" to enter the recovery settings. (Also you can choose "Continue" to exit recovery system and continue to Windows 10 for files or data backup.)



There are two options for system recovery

- **Reset this PC**
You can choose to keep or remove your files and then reinstalls Windows without losing your files.
- **GIGABYTE Smart Recovery**
Your PC settings will be restored to factory default settings.
Caution: All personal data and files will be lost.

4



■ Choose "Reset this PC"

▶ Keep my files

Choose an account to continue. All apps will be removed, and settings will be back to pure O/S (without GIGABYTE app), but your personal files will be kept.

▶ Remove everything

All apps, setting and personal files will be removed.

⇒ Just remove my files

Only personal data and files will be removed, but computer settings will be kept.

⇒ Fully clean the drive

The drive will be completely restored to factory default settings. It takes more time. > [Click on "Reset" to execute recovery function.]



Here are what will happen

- All of your personal files and apps will be removed.
- Your PC settings will be restored to pure O/S (without GIGABYTE app) .



■ GIGABYTE Smart Recovery



The recovery will be activated and you will see the option buttons on the window. Click on "Yes" to start it.



Caution

- Once the "Recovery" is selected, your personal data and files will be deleted after the laptop starts restoring, and the operating system will be reset to factory default settings.
- A progress indicator bar will show on the window when the recovery process is running. Please make sure the AC-adaptor is plugged in and do not turn off the laptop.



After the system recovery is completed, you will see the option button on the window, please click on "Shutdown".



■ Advanced options



System Restore

Use a restore point recorded on your PC to restore Windows.



System Image Recovery

Recover Windows using a specific system image file.



Startup Repair

Fix problems that keep Windows from loading.



Command Prompt

Use the Command Prompt for advanced troubleshooting.



UEFI Firmware Settings

Change settings in your PC's UEFI firmware.



Startup Settings

Change Windows Startup behavior.

Appendix

■ Warranty & Service:

Warranty and service and related information please refer to the warranty card or GIGABYTE service website as the below link:

<https://www.gigabyte.com/Support/Laptop>

■ FAQ:

FAQ (Frequent Asked Questions) please refer to the below

<https://www.gigabyte.com/Support/Faq>

■ Full User Manual:

For more user guide and software instruction, please refer to the below link: <http://www.gigabyte.com/support-downloads/download-center.aspx>

感謝您選擇技嘉筆記型電腦！

為協助您順利使用技嘉筆記型電腦，我們特地設計此快速安裝說明。如果您需要更多關於電腦功能資訊，歡迎上技嘉官方網站www.gigabyte.tw查詢。產品實際規格以出貨為準，如有異動恕不另行通知。

首次使用 GIGABYTE 技嘉筆記型電腦

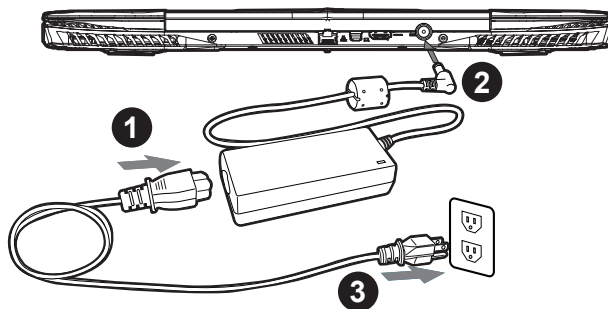

- 1 將電源線接上變壓器。
- 2 將變壓器連接到筆記型電腦後側的電源插孔。
- 3 將電源線插入電源插座。

⚠ 重要

第一次啟動筆記型電腦之前，請先確認已經將電源變壓器連接至電腦。

找出筆記型電腦的輸入/輸出頻率標籤，並請確認符合電源變壓器上的輸入/輸出頻率資訊。

當筆記型電腦在電源變壓器使用模式時，請將電源變壓器靠近插座以方便使用。

電源變壓器資訊：輸入電壓：100-240Vac 輸入頻率：50-60Hz 輸出電壓功率：19.5V,9.23A

開啟筆記型電腦

電源指示燈會顯示機器是否為開機狀態。第一次開機時在還未完全進入作業系統前，請勿強制關機。開啓電源後直到該作業系統配置完成前，音量將無法設定。

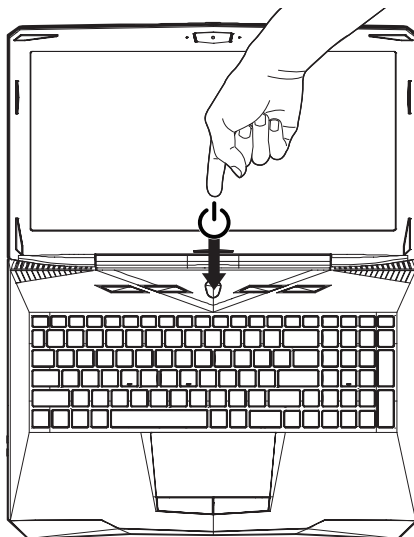

開始第一次使用筆記型電腦：

根據您的筆記型電腦配置，當您一開機的第一個畫面將會是微軟 Windows® 的啟動畫面，請按照該螢幕上的提示和指示完成作業系統的配置。當軟體的許可條款顯示於畫面時，請務必閱讀並按同意後再繼續使用。

GIGABYTE 技嘉筆記型電腦導覽

上視圖

- 1 視訊攝影機
- 2 視訊攝影機指示燈
- 3 麥克風
- 4 電源開關
- 5 觸控板

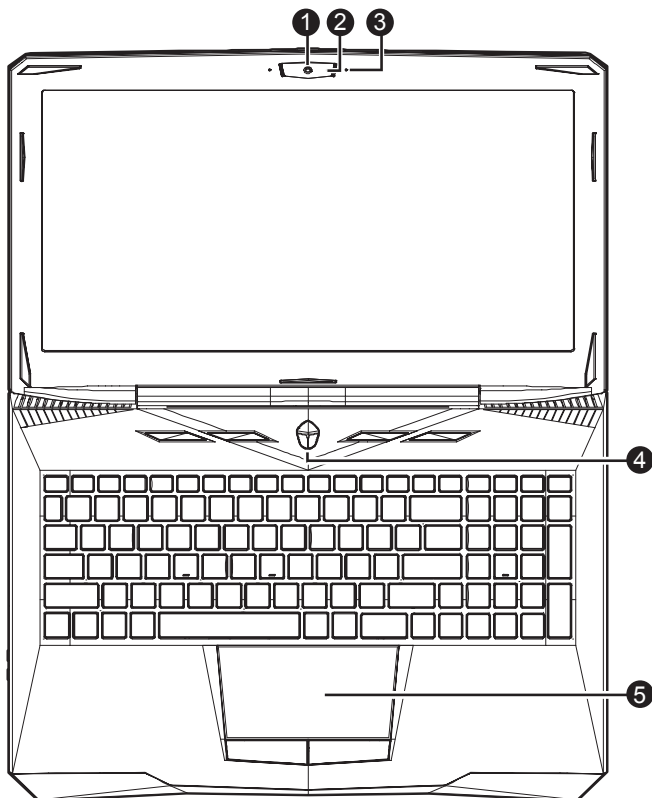

警語：使用過度恐傷害視力。

注意事項：

- (1) 使用30分鐘請休息10分鐘。
- (2) 未滿2歲幼兒不看螢幕，2歲以上每天看螢幕不要超過1小時。

左視圖

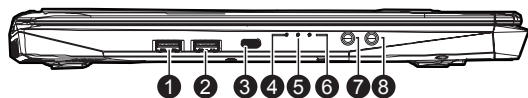

- 1 USB 3.1 Gen.1埠
- 2 USB 3.1 Gen.1埠
- 3 USB 3.1 Gen.2埠 (Type-C)*
*以10Gb/s速度傳輸資料
- 4 電池充電顯示燈
- 5 硬碟存取指示燈
- 6 無線網路指示燈
- 7 麥克風插孔
- 8 耳機插孔

右視圖

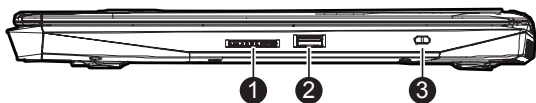

- 1 SD讀卡機
- 2 USB 3.1 Gen.1埠
- 3 Kensington防盜鎖孔

後視圖

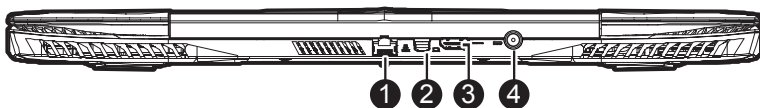

- 1 乙太網路(LAN)埠
- 2 MiniDisplay埠
- 3 HDMI埠
- 4 電源插孔



警告：

本機器設備配備的鋰電池為不可拆卸裝置，請交由技嘉授權專業維修服務中心移除裝置中的電池。

- 請不要於斜面上或容易震動的地方使用筆記型電腦，以降低發生故障和產品損壞的風險。
- 請勿置於車內、室內外陽光強烈或高於45度C之儲藏環境，以免鋰電池發生老化或膨脹等危險。
- 請於通風良好的地方使用此產品。請勿在床上、枕頭等通風不良的地方使用此產品，並且不要在有樓板暖氣的地方使用，避免導致筆記型電腦過熱。請避免底部和側邊的通風孔阻塞。如果通風孔阻塞，會有損害筆記型電腦或導致內部過熱的危險。

快速鍵

許多電腦的設定例如螢幕亮度、喇叭音量等可利用電腦的快速鍵直接調整。如需使用快速鍵，請依下表先按住 <Fn> 鍵，再按下<F1>~<F12>等按鍵。

快速鍵	功能	功能敘述
Fn+!  	風扇調整	風扇全開/一般轉速調整
Fn+F2  	飛航模式	開啓/關閉飛航模式。
Fn+F4  	電源調整	電源模式調整
Fn+F5  	減弱亮度	降低螢幕亮度。
Fn+F6  	增強亮度	提高螢幕亮度。
Fn+F7  	螢幕開關	開啓/關閉螢幕。
Fn+F8  	螢幕顯示切換	在電腦螢幕以及外接式顯示器之間切換影像輸出, 或者同時顯示。
Fn+F9  	觸控板開關	開啓/關閉觸控板。
Fn+F10  	喇叭開關	開啓/關閉喇叭。
Fn+F11  	減弱音量	降低喇叭音量。
Fn+F12  	增大音量	提高喇叭音量。
Fn+Z  	減弱鍵盤背光	降低鍵盤背光亮度。
Fn+X  	增強鍵盤背光	提高鍵盤背光亮度。

控制中心

Control Center

具備電源管理，巨集設定以及鍵盤燈光效果控制平台，提供快速且便利的個人化設定體驗。

5

繁體中文



電源配置

- 1 平衡模式
- 2 效能模式
- 3 省電模式
- 4 極省電模式

獨立巨集鍵設置

- 1 選擇M1-M4任意巨集鍵，即會跳出hotkey設定視窗。
- 2 共有以下五種設定可供選擇。
 - (1) 預設：鎖定Windows按鍵
 - (2) 電源：選擇任一電源模式
 - (3) 巨集：選擇任一巨集檔案
 - (4) 鍵盤燈光：選擇任一鍵盤燈光特效
 - (5) 關閉：關閉巨集功能
- 3 點選“設定(Apply)”即完成巨集鍵設置

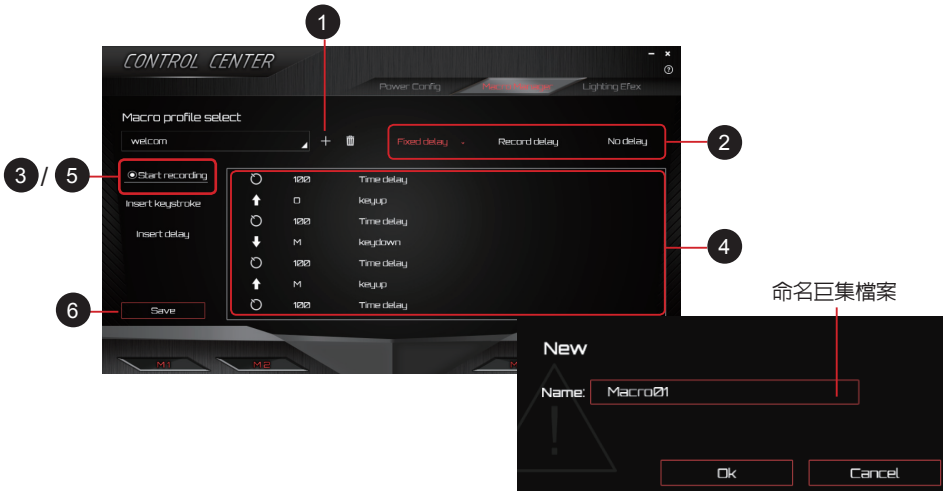

巨集鍵管理

- 使用按鍵"+"新增巨集檔案並命名。
- 如果需加上延遲時間，請選擇固定延遲時間(fixed delay)或者紀錄實際延遲時間(record delay)。如不需要延遲時間，請選擇不需延遲(No delay)。
- 使用"Start recording"開始巨集檔案紀錄，同時此選項會轉變為紅色。
- 開始輸入您的巨集設定內容。
- 當結束輸入內容時，請再次按下"Start recording"，此選項會回復原有的白色，表示錄製停止。
- 按下 "Save"儲存巨集檔案。



鍵盤燈光效果管理

- 使用按鍵"+"新增燈效檔案並命名。
- 共有五種特效可供選擇：static, random, off, breathing & cycling。

Smart USB Backup 使用說明

警告

- 為避免儲存裝置毀損導致原廠的還原映像檔遺失，您可以透過此軟體來備份原廠的還原映像檔。
- 如果您想更換新的儲存裝置，您可以透過此軟體將原廠還原映像檔備份至 USB 隨身碟，安裝好新的儲存裝置後，再將出廠的預設系統倒回新儲存裝置。
- 使用本軟體所製作的還原 USB 隨身碟將系統還原以前，請先做好資料備份，以免資料流失。
- 利用還原 USB 隨身碟進行系統還原時，請勿移除或關掉電源。

7

繁體中文

1



- 若要製作原廠映像檔的還原 USB 隨身碟，請先插入容量至少有 32GB 的 USB 隨身碟（請先將 USB 隨身碟裡原有的資料備份，避免因下述操作造成 USB 隨身碟裡的資料遺失）。

2



- 放入驅動程式光碟，執行安裝“Smart USB Backup”。（無內建光碟機的機種，請外接 USB 光碟機；若光碟內沒有軟體，請上 <http://www.gigabyte.com> 下載）。

3



- 安裝完成後，執行桌面上的“Smart USB Backup”。

4



- 從清單中選取剛剛插入的 USB 隨身碟，然後選擇建立還原 USB。

5

- 跳出結束視窗後即完成。
- 若要還原您的系統，請在開機時按 ESC，選擇用【USB 隨身碟開機】，【USB 隨身碟】會自動完成還原您的系統。
- 還原時間約需 30 分鐘（所需時間會因 USB 隨身碟種類而有所不同）。

系統還原使用說明

8

繁體中文

系統還原（修復您的筆記型電腦作業系統）

當作業系統使用上出現不穩定的情況，筆記型電腦原廠出貨的儲存裝置裡有一個隱藏磁區，其內容為作業系統的完整備份映像檔，可以用來救援系統將儲存裝置裡的作業系統還原到出廠預設值。



注意

- 如果儲存裝置有被更換過或刪除該隱藏磁區，還原功能將無法使用，需送維修中心還原。
- 出廠規格為預搭作業系統時才有此還原功能，若是 DOS 銷售則不提供此功能。

啟動系統還原

系統還原功能是筆記型電腦出廠時被預先安裝的。該選項可以啟動 Windows 故障還原工具，重新安裝作業系統為出廠預設值。

以下為簡要介紹如何啟動還原工具，並開始還原系統。



執行還原前請注意

確認筆記型電腦已接上外接電源，還原系統會花費幾分鐘的時間。

Windows 10 系統還原說明

1

關機並重新啟動筆記型電腦。

2



啟動筆記型電腦後，按著 F9 按鍵幾秒鐘以啟動還原工具。

3



選擇“Troubleshoot”進入系統還原及進階選項。

（您也可以選擇“Continue”直接進入 Windows 10 作業系統，先行備份個人資料與檔案再作還原。或選擇“Turn off your PC”關機並重新啟動筆記型電腦。）



系統還原有兩種方式可供選擇

- Reset this PC
如果電腦因軟體或設定值不佳而不穩定，您可以選擇移除或保留個人檔案，在重設電腦設定值而不遺失個人檔案。
- GIGABYTE Smart Recovery
筆記型電腦的設定值會被還原成出廠預設值。
注意：將會遺失所有的個人資料與檔案。

4



Reset this PC - 重設電腦設定值

- ▶ **Keep my files** - 保留個人檔案
選擇一個使用者帳戶後繼續。所有應用程式會被移除，設定值會還原成單純的 O/S (不含 GIGABYTE 應用程式)，但個人檔案會被保留。
- ▶ **Remove everything** - 移除所有項目
所有應用程式、設定值和個人檔案將會被移除。
 - ⇒ **Just remove my files** - 只移除個人檔案
只移除個人檔案，但保留電腦設定值。
 - ⇒ **Fully clean the drive** - 完整還原
完整還原儲存裝置至出廠設定值，會花費較長的還原時間。
>【按下“Reset”執行】。



注意事項

- 您所有的個人檔案與應用程式將會被移除。
- 所有的電腦設定值將會被還原成單純的 O/S (不含 GIGABYTE 應用程式)。



GIGABYTE Smart Recovery



進入重置系統模式，工具列會有還原選項，如您確定要系統還原，點選“是”執行。



注意事項

- 一選擇還原後，所有原本的個人資料與檔案將被刪除，並還原系統及儲存裝置至出廠預設值。
- 還原視窗開啟並進行系統還原，在這之時請確認接上變壓器確保電力無虞，並請勿關閉電源。

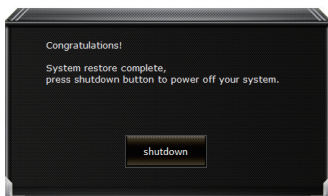

當系統還原完成後，工具列會有選項，請點選“關機”



- **Advanced options 其它或進階選項**
更多系統還原的進階設定。



- System Restore 系統還原**
選擇系統還原的記錄時間，將系統還原至該時間點。



- System Image Recovery 系統備份還原**
使用之前備份的系統備份資料還原 Windows 系統。



- Startup Repair 啟動修復程序**
修復及解決 Windows 系統問題。



- Command Prompt 命令提示字元**
使用命令字元集執行進階的疑難排解。



- UEFI Firmware SettingsUEFI BIOS 設定**
重新啟動，變更 UEFI BIOS 設定值。



- Startup Settings 啟動設置**
變更 Windows 啟動設定。

附錄

- **保固及客服資訊：**

- 相關保固條款及客服資訊請參考隨貨所附之保固保證書，或參考技嘉技術服務區網站。
<https://www.gigabyte.com/tw/Support/Laptop>

- **FAQ：**

- 相關常見問題請參考技嘉常見問題網站。
<http://www.gigabyte.tw/Support/Faq>

- **完整使用說明書：**

- 詳細筆電使用說明與軟體操作說明，請至技嘉 Download-Center 下載電子說明書。
<http://www.gigabyte.com/support-downloads/download-center.aspx>

기가바이트 노트북 구입을 축하합니다.

이 매뉴얼은 노트북의 초기설정을 도와드립니다. 구성 내용은 구입시기에 따라 다를 수 있습니다.

이 매뉴얼의 내용은 사전 통보없이 수정될 수 있습니다. 자세한 내용은 www.gigabyte.com 사이트를 참고해 주세요.

기가바이트 노트북 처음으로 사용하기

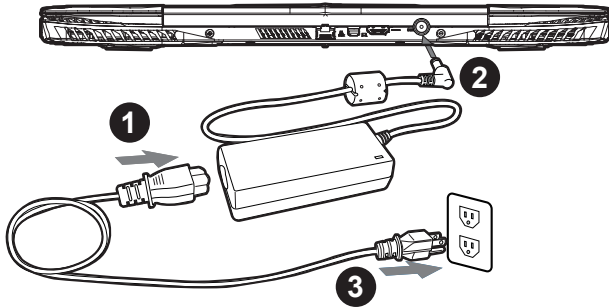

- 1 전원코드를 AC 아답터에 연결해주세요.
- 2 AC 아답터를 노트북 뒷면의 DC-in 잭에 연결 하십시오
- 3 전원코드를 전원에 연결해주세요.

전원 켜기:

맨 처음 노트북을 켤때는 운영체제의 설정이 끝날때까지 전원을 끄지 마십시오
오디오 기능은 윈도우 설정이 끝나기 전에는 동작하지 않을 수 있습니다.

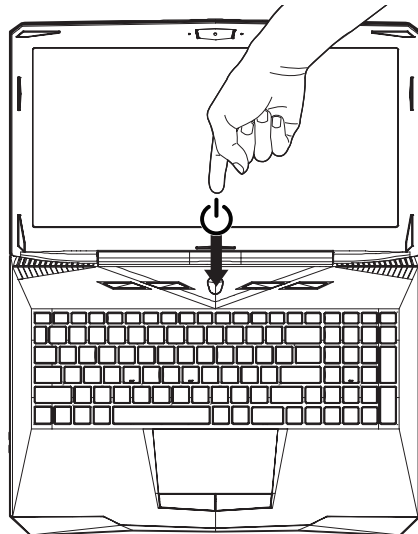

처음으로 부팅하기 :

노트북을 켜면 설정에 따라 윈도우 부팅 화면이 나타나게 될 것입니다. 화면의 프롬프트와 안내에 따라, 사용자 정보를 입력하면 윈도우 설정이 완료됩니다.

기가바이트 노트북 알아보기

상부 & 앞면

2

하
위
어

- 1 웹캠
- 2 웹캠 표시기
- 3 마이크
- 4 전원버튼
- 5 터치패드

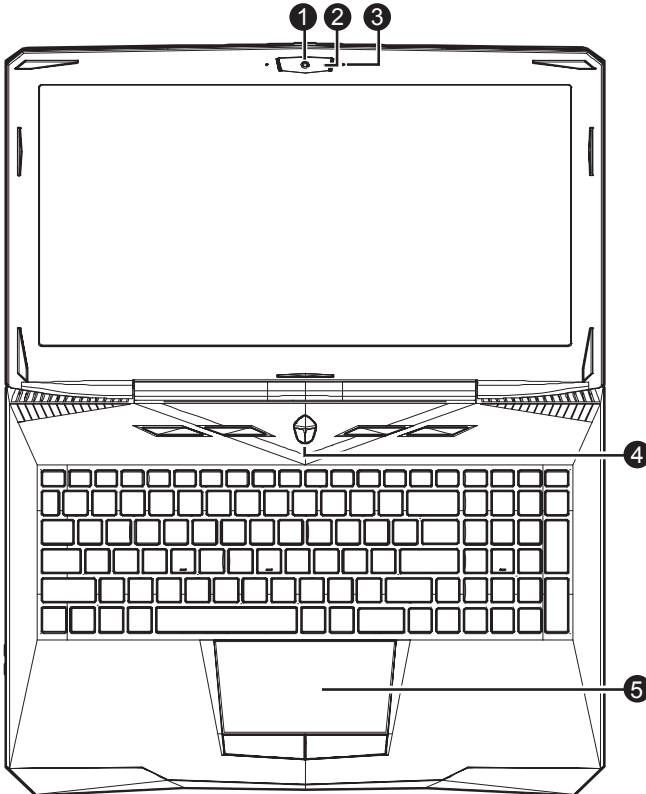

좌측면

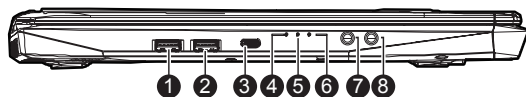

- 1 USB 3.1 Gen.1 포트
- 2 USB 3.1 Gen.1 포트
- 3 USB 3.1 Gen.2 포트 (Type-C)
- 4 배터리 표시기
- 5 하드디스크 상태 표시등
- 6 무선랜 상태 표시등
- 7 마이크로폰 삽입 단자
- 8 헤드폰 출력 단자

우측면

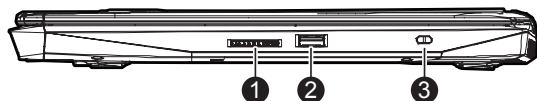

- 1 SD 카드리더
- 2 USB 3.1 Gen.1 포트
- 3 캔싱턴락홀

바닥면

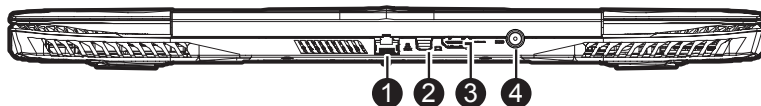

- 1 유선랜 포트
- 2 미니 디스플레이 포트
- 3 HDMI 포트
- 4 DC-in 잭



경고 :

어떤 서비스 목적이거나 리튬배터리를 제거하지 마십시오. 각 지역 지정된 공식 기가바이트 서비스 센터에 연락하십시오.

- 노트북을 경사가 진 곳이나 진동이 있는 부분에서 설치를 하시거나 장시간 사용을 삼가 하십시오. 이는 제품의 이상이나 문제를 야기 시킬 수 있습니다.
- 태양 직사광선에서의 사용이나 노출 혹은 자동차와 같이 실내 온도가 112°F (45°C)이상의 곳에서는 사용을 피하십시오. 이는 리튬 배터리의 폭발이나 수명 단축을 야기 시킬 수 있습니다.
- 침대, 쿠션, 베개 밑과 같이 통풍이 좋지 않거나 밀폐된 공간에서의 사용을 금하십시오. 또한 바닥이 따뜻한 온돌 등에서의 사용은 노트북의 과열을 초래 하여 기능이상이나 사용상의 문제를 야기 시킬 수 있습니다.

단축키 안내

화면밝기, 음량조절과 같은 대부분의 기능을 제어하기 위한 단축키를 제공합니다.
단축키를 사용하려면 <Fn> 키를 누른채로 해당 기능의 키를 함께 누릅니다.

단축키	기능	안내
Fn+!  	팬스위치	팬을 최고/일반 속도로 조절
Fn+F2  	비행모드	비행모드 활성화/ 비활성화
Fn+F4  	전원관리	다양한 전원 모드 조절
Fn+F5  	밝기 감소	화면의 밝기를 감소시킵니다.
Fn+F6  	밝기 증가	화면의 밝기를 증가시킵니다.
Fn+F7  	액정 켜고 끄기	노트북의 액정을 켜거나 끕니다.
Fn+F8  	디스플레이 선택	노트북 액정 / 외부모니터 어느쪽에 화면을 표시할 지 선택합니다. 동시 출력도 가능합니다.
Fn+F9  	터치패드 잠금	터치패드 기능을 켜거나 끕니다.
Fn+F10  	음소거	소리는 켜거나 끕니다.
Fn+F11  	음량 감소	음량을 감소시킵니다.
Fn+F12  	음량 증가	음량을 증가시킵니다.
Fn+Z  	키보드 백라이트 밝기 감소	키보드 백라이트의 밝기를 감소 조절
Fn+X  	키보드 백라이트 밝기 증가	키보드 백라이트 밝기 증가 조절

스마트 USB 백업 안내

⚠ 주의

- 장치 손상으로 인해 복구 이미지가 손상된 경우, 이 프로그램을 통해 원래의 복구 이미지를 백업할 수 있습니다.
- 저장장치의 변경없이 USB 디스크를 통해, 원래의 복구이미지를 USB 디스크에 저장하고 복원할 수 있습니다.
- 복원을 진행하기 전에, 중요 데이터의 백업을 반드시 확인하십시오.
- 데이터 복원중에는 절대로 전원을 끄거나 전원에서 분리하지 마십시오.

1



- 오리지널 이미지를 저장하기 위해, 32GB 이상의 용량이 확보된 USB 디스크를 연결하십시오.
(USB 복구 디스크를 작성하는 도중에 USB 디스크 안의 모든 데이터가 삭제되므로 중요한 데이터는 반드시 백업하십시오.)

2



- 드라이버 디스크를 ODD 에 삽입하고 "Smart USB Backup" 프로그램을 실행합니다. (ODD 가 없는 모델은 USB 방식의 ODD 를 이용하거나, <http://www.gigabyte.com> 에서 다운로드 하십시오.)

3



- "Smart USB Backup" 설치 과정을 완료합니다.

4



- 드롭다운 목록에서 USB 디스크를 선택하고 USB 복구 디스크 작성을 시작합니다.

5

- USB 복구 디스크 작성이 완료되면 팝업창이 표시됩니다.
- 복구가 필요한 경우, 전원을 켜고 ESC 키를 누른 뒤 "boot from recovery USB disk" 항목을 선택하면 시스템이 복원됩니다.
- 복구 과정에는 약 30 분 정도가 소요됩니다.
(USB 디스크 종류에 따라 소요시간은 달라질 수 있습니다.)

복원 가이드

시스템복원 (당신의 노트북의 운영체제를 복원)

노트북운영체제에 무엇인가 이상이 생겼을시, 노트북의 숨겨진 파티션에 저장되어 있는 운영체제 복원기능을 통해 노트북을 공장출시상태의 세팅으로 복원을 시킬 수 있습니다.



참고

- 만일 저장장치가 커지거나 교환되거나 파티션이 삭제가 되면 복원선택사항은 더 이상 이용 할 수 없습니다.
- 복원 기능은 운영체제가 기본 내장되어 있는 노트북에서만 가능하며, 운영체제가 저장되어 있지 않은 노트북을 구매 하셨을 경우 복원 기능은 불가능 합니다.

시스템 복원장치 실행하기

시스템 복원장치는 노트북이 공장에서 출하하기 전에 이미 설치되어 있으며, 선택메뉴를 통해 윈도우 복원 도구를 실행하여 운영체제를 공장세팅모드로 복원을 시킬 수 있습니다.

아래의 간단한 설명을 통해 어떻게 운영체제 복원을 실행 할 수 있는지 보여줄 것입니다.



준비

PC가 전원에 연결된것을 확인 부탁드리며, 몇분이 소요 될 수 있습니다.

윈도우 10 복원 가이드

1 전원꺼 후 노트북 재 부팅 하기

2



노트북이 부팅을 시작 할 시 F9 키를 눌러 도구를 실행 하십시오.

3



“Troubleshoot” 을 선택하여 복원 세팅으로 진입 하십시오. (“Continue” 를 선택하여 복원 시스템에서 나가기를 할 수 있으며, 윈도우 10 파일 데이터 백업으로 진행 할 수 있습니다.)



시스템 복원 리셋을 하기 위해서는 2 가지 선택사항이 있습니다.

- **Reset this PC - PC 리셋 하기**
- 사용자는 파일을 제거 혹은 지우지 않은 상태에서 윈도우를 재 설치 가능합니다.
- **GIGABYTE Smart Recovery**
이 선택사항은 당신의 PC 를 공장출시 규격으로 재 세팅 될것이며, 모든 데이터와 파일은 잃게 될것입니다.

“PC 리셋하기” 선택



■ Reset this PC - “PC 리셋하기” 선택

▶ Keep my files 나의 파일 보존하기

계정을 선택하여 계속 하십시오.

모든 어플은 제거 될 것이며, 운영체제는 초기 값으로 재 설정 됩니다. (기가바이트 어플 제외), 그러나 개인적인 파일은 보존 될 것입니다.)

▶ Remove everything 모든 것을

모든 어플, 세팅, 파일은 제거 되지만 컴퓨터 세팅은 유지 될 것입니다.

⇨ Just remove my files - 파일만 제거 하기

오직 데이터와 파일만 삭제 될 것입니다. 그러나 컴퓨터 세팅은 유지 될 것입니다.

⇨ Fully clean the drive - 드라이브 청소하기

드라이브는 완전히 재 복원 될 것이며, 당신의 노트북은 순수 운영체제 값이 됩니다. (기가바이트 어플 제외)



앞으로 진행될

모든 개인 데이터와 어플은 삭제 될 것입니다. 당신의 노트북은 완전히 순수 운영체제 값으로 복원될 것입니다.



■ GIGABYTE Smart Recovery



복원이 활성화 될 것이며, 화면의 “YES”를 선택하여 시작 합니다.



경고

- 복원이 선택이 되면, 복원 후에는 모든 개인 데이터와 파일은 제거 될 것입니다. 또한 운영체제는 공장도 값으로 재 설정 됩니다. 진행상태를 나타내는 표시 바가 표시 될 것입니다.



시스템 복원이 완료가 되면, 윈도우 창의 “전원 끄기” 버튼이 나오면 선택을 하십시오.



■ Advanced options 고급 선택사항



System Restore 시스템복원

당신의 PC 에 저장된 기록 시점을 사용 합니다 .



System Image Recovery 시스템 이미지 복원

특정 시스테 이미지를 사용하여 윈도우를 복원 합니다 .



Startup Repair 시작 리페어

윈도우의 로딩 문제시 문제를 해결 합니다 .



Command Promp 명령 실행

명령 실행을 통해서 고급 트러블 슈팅 을 사용 합니다 .



UEFI Firmware Settings UEFI BIOS UEFI 펌웨어 세팅

당신의 PC 에서 UEFI 펌웨어를 변경 합니다 .



Startup Setting 시작 세팅

윈도우의 시작 행동을 변경합니다 .

부록

■ 보증 &서비스 :

보증 , 서비스 그리고 이와 관련된 정보는 워런티 카드를 참조 하시거나 아래의 링크의 기가바이트 사이트를 참고 하십시오

<https://www.gigabyte.com/Support/Laptop>

■ 자주 묻는 질문 :

FAQ(자주 묻는 질문) 은 다음의 링크를 참조 하십시오 .

<https://www.gigabyte.com/Support/Faq>

■ 사용 설명서 :

상세 노트북 사용 설명 및 소프트웨어 작동 설명은 기가바이트 다운로드 센터에서 다운로드 받을 수 있습니다 .

<http://www.gigabyte.com/support-downloads/download-center.aspx>