

Z890 AERO G

User's Manual

Rev. 1003



GIGABYTE will reduce paper use in order to fulfill the responsibilities of a global citizen. Also, to reduce the impacts on global warming, the packaging materials of this product are recyclable and reusable. GIGABYTE works with you to protect the environment. For more product details, please visit GIGABYTE's website.

Copyright

© 2024 GIGA-BYTE TECHNOLOGY CO., LTD. All rights reserved.

The trademarks mentioned in this manual are legally registered to their respective owners.

Disclaimer

Information in this manual is protected by copyright laws and is the property of GIGABYTE. Changes to the specifications and features in this manual may be made by GIGABYTE without prior notice. No part of this manual may be reproduced, copied, translated, transmitted, or published in any form or by any means without GIGABYTE's prior written permission.

- For detailed product information, carefully read the User's Manual.
- For quick set-up of the product, refer to the Quick Installation Guide on GIGABYTE's website.

https://download.gigabyte.com/FileList/Manual/mb_manual_installation-guide_800series.pdf

For product-related information, check on our website at: <https://www.gigabyte.com>

Identifying Your Motherboard Revision

The revision number on your motherboard looks like this: "REV: X.X." For example, "REV: 1.0" means the revision of the motherboard is 1.0. Check your motherboard revision before updating motherboard BIOS, drivers, or when looking for technical information.

Example:

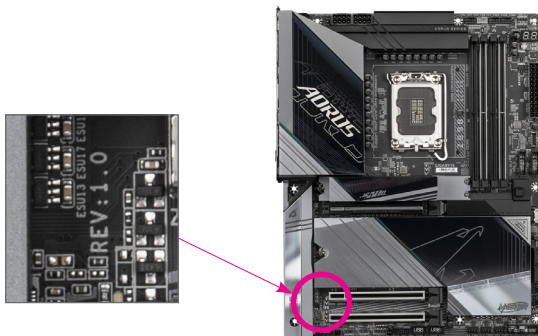
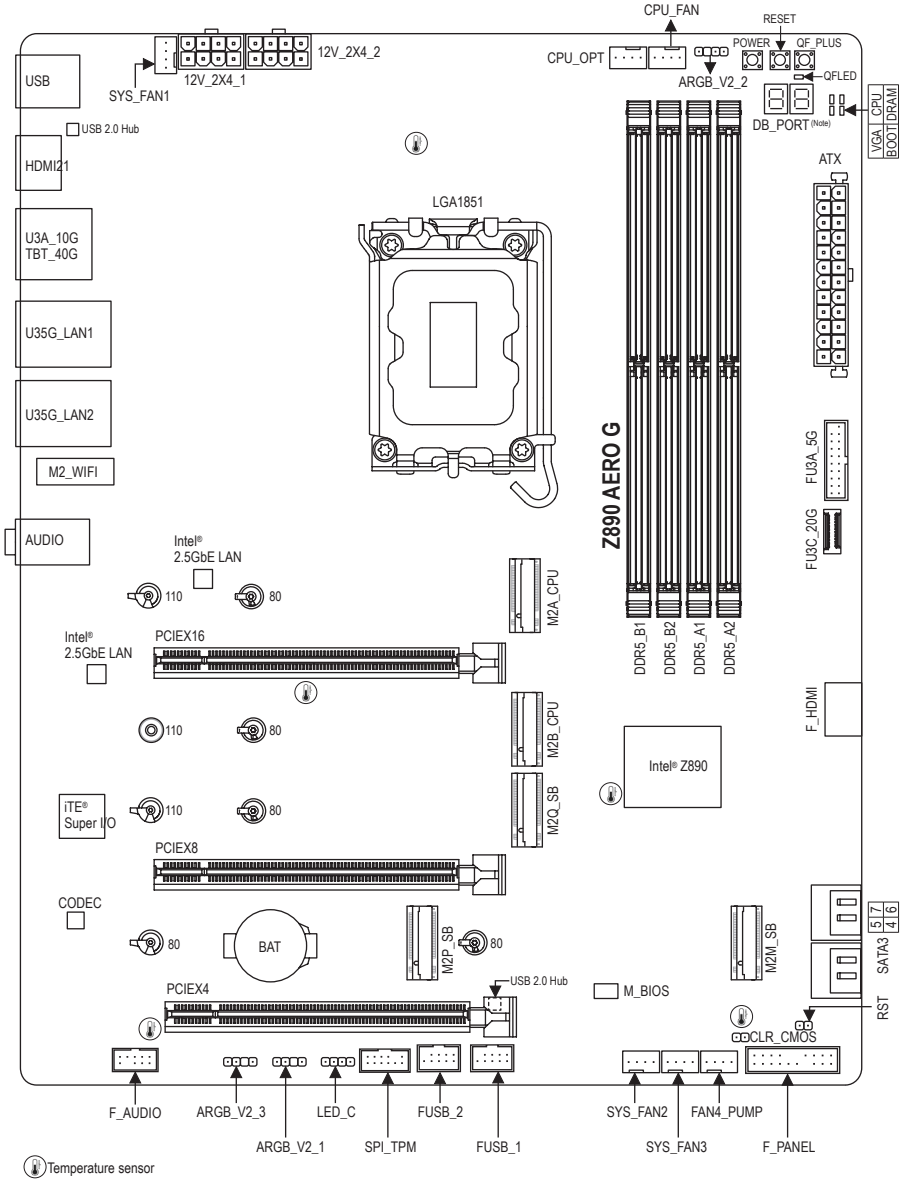

Table of Contents

Chapter 1 Product Introduction	4
1-1 Motherboard Layout	4
1-2 Motherboard Block Diagram	5
1-3 Box Contents	6
Chapter 2 Hardware Installation	7
2-1 Installation Precautions	7
2-2 Product Specifications	8
2-3 Installing the CPU and CPU Cooler	12
2-4 Installing the Memory	15
2-5 Installing an Expansion Card	16
2-6 Back Panel Connectors	17
2-7 Onboard Buttons and LEDs	19
2-8 Internal Connectors	21
Chapter 3 BIOS Setup	34
Chapter 4 Installing the Operating System and Drivers	36
4-1 Operating System Installation	36
4-2 Drivers Installation	37
Chapter 5 Appendix	38
5-1 Configuring a RAID Set	38
5-2 Debug LED Codes	39
Regulatory Notices	43
Contact Us	46

Chapter 1 Product Introduction

1-1 Motherboard Layout



(Note) For debug code information, please refer to the "Debug LED Codes" pages.

1-2 Motherboard Block Diagram

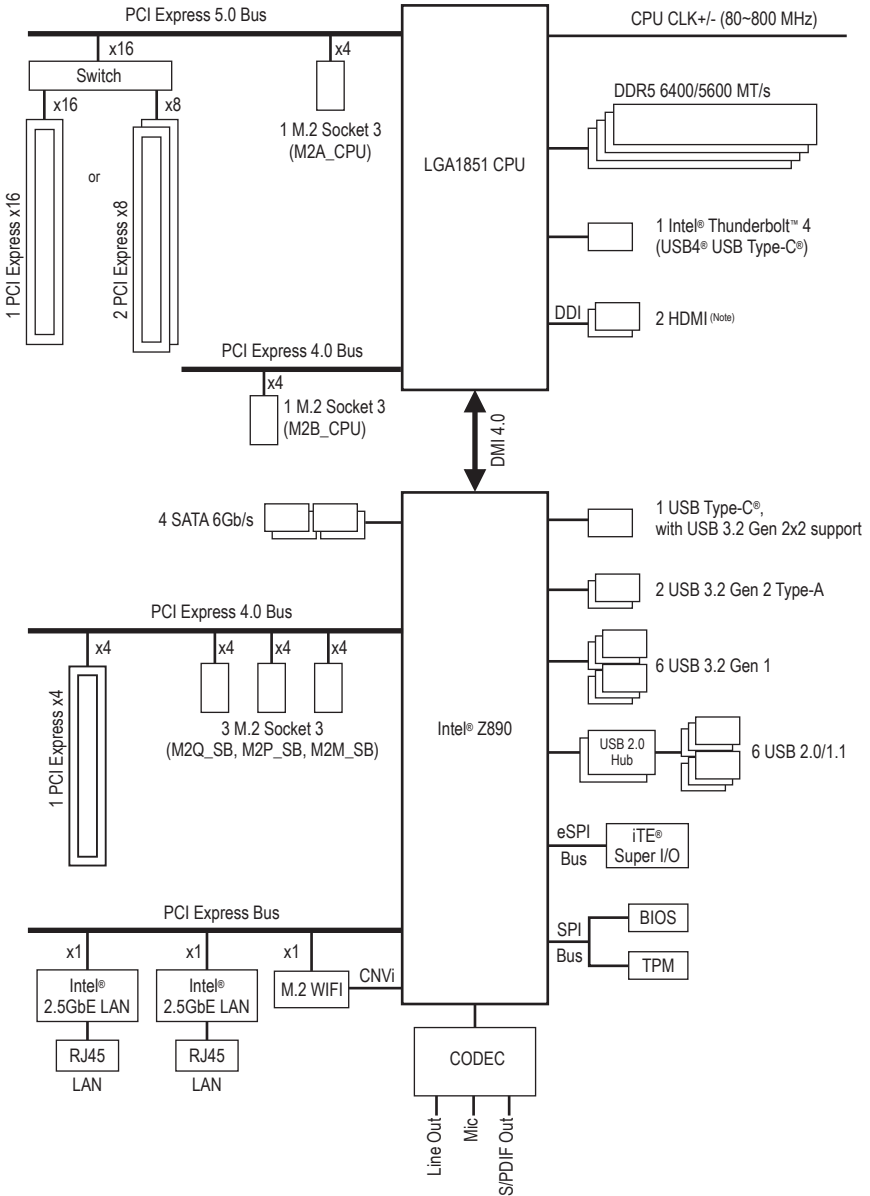

(Note) Actual support may vary by CPU.

1-3 Box Contents

- Z890 AERO G motherboard
- User's Manual
- Quick Installation Guide
- One antenna
- Two SATA cables
- One M.2 thermal pad
- Four packs of M.2 thick/thin rubber pads

* The box contents above are for reference only and the actual items shall depend on the product package you obtain.
The box contents are subject to change without notice.







Chapter 2 Hardware Installation





2-1 Installation Precautions

The motherboard contains numerous delicate electronic circuits and components which can become damaged as a result of electrostatic discharge (ESD). Prior to installation, carefully read the user's manual and follow these procedures:

- Prior to installation, make sure the chassis is suitable for the motherboard.
- Prior to installation, do not remove or break motherboard S/N (Serial Number) sticker or warranty sticker provided by your dealer. These stickers are required for warranty validation.
- Always remove the AC power by unplugging the power cord from the power outlet before installing or removing the motherboard or other hardware components.
- When connecting hardware components to the internal connectors on the motherboard, make sure they are connected tightly and securely.
- When handling the motherboard, avoid touching any metal leads or connectors.
- It is best to wear an electrostatic discharge (ESD) wrist strap when handling electronic components such as a motherboard, CPU or memory. If you do not have an ESD wrist strap, keep your hands dry and first touch a metal object to eliminate static electricity.
- Prior to installing the motherboard, please have it on top of an antistatic pad or within an electrostatic shielding container.
- Before connecting or unplugging the power supply cable from the motherboard, make sure the power supply has been turned off.
- Before turning on the power, make sure the power supply voltage has been set according to the local voltage standard.
- Before using the product, please verify that all cables and power connectors of your hardware components are connected.
- To prevent damage to the motherboard, do not allow screws to come in contact with the motherboard circuit or its components.
- Make sure there are no leftover screws or metal components placed on the motherboard or within the computer casing.
- Do not place the computer system on an uneven surface.
- Do not place the computer system in a high-temperature or wet environment.
- Turning on the computer power during the installation process can lead to damage to system components as well as physical harm to the user.
- If you are uncertain about any installation steps or have a problem related to the use of the product, please consult a certified computer technician.
- If you use an adapter, extension power cable, or power strip, ensure to consult with its installation and/or grounding instructions.





2-2 Product Specifications

	CPU	<ul style="list-style-type: none"> ◆ LGA1851 socket: Support for Intel® Core™ Ultra Processors (Go to GIGABYTE's website for the latest CPU support list.) ◆ L3 cache varies with CPU
	Chipset	<ul style="list-style-type: none"> ◆ Intel® Z890 Express Chipset
	Memory	<ul style="list-style-type: none"> ◆ Support for DDR5 6400/5600 MT/s memory modules ◆ 4 x DDR5 DIMM sockets supporting up to 256 GB (64 GB single DIMM capacity) of system memory ◆ Dual channel memory architecture ◆ Support for ECC Un-buffered DIMM 1Rx8/2Rx8 memory modules (operate in non-ECC mode) ◆ Support for non-ECC Un-buffered DIMM 1Rx8/2Rx8/1Rx16 memory modules ◆ Support for Extreme Memory Profile (XMP) memory modules <p>(The CPU and memory configuration may affect the supported memory types, data rate (speed), and number of DRAM modules, please refer to "Memory Support List" on GIGABYTE's website for more information.)</p>
	Onboard Graphics	<ul style="list-style-type: none"> ◆ Integrated Graphics Processor-Intel® HD Graphics support: <ul style="list-style-type: none"> - 1 x Intel® Thunderbolt™ 4 connector (USB4® USB Type-C® port), supporting DisplayPort and Thunderbolt™ video outputs <ul style="list-style-type: none"> ▶▶ When a Thunderbolt™ monitor is installed, the maximum resolution supported is 5120x2880@60 Hz with 24 bpp (single display output). ▶▶ When a USB4® USB Type-C® monitor is installed, the maximum resolution supported is 3840x2160@240 Hz (single display output). * Because of the limited I/O resources of the PC architecture, the number of Thunderbolt™ devices that can be used is dependent on the number of the PCI Express devices being installed. (Refer to Chapter 2-6, "Back Panel Connectors," for more information.) * Support for DisplayPort 2.1 version and HDCP 2.3 - 1 x HDMI port, supporting a maximum resolution of 4096x2160@60 Hz <ul style="list-style-type: none"> * Support for HDMI 2.1 version and HDCP 2.3. - 1 x front HDMI port, supporting a maximum resolution of 1920x1080@30 Hz <ul style="list-style-type: none"> * Support for HDMI 1.4 version. <p>(Graphics specifications may vary depending on CPU support.)</p> <ul style="list-style-type: none"> ◆ Support for up to triple-display at the same time
	Audio	<ul style="list-style-type: none"> ◆ Realtek® ALC1220 CODEC <ul style="list-style-type: none"> * The back panel line out jack supports DSD audio. ◆ High Definition Audio ◆ 2/4/5.1/7.1-channel <ul style="list-style-type: none"> * You can change the functionality of an audio jack using the audio software. To configure 7.1-channel audio, access the audio software for audio settings. ◆ Support for S/PDIF Out
	LAN	<ul style="list-style-type: none"> ◆ 2 x Intel® 2.5GbE LAN chips (2.5 Gbps/1 Gbps/100 Mbps)

 Wireless Communication Module	<ul style="list-style-type: none"> ◆ Intel® Wi-Fi 7 BE202 (BE200NGW M) <ul style="list-style-type: none"> - 802.11a, b, g, n, ac, ax, be, supporting 2.4/5/6 GHz carrier frequency bands - BLUETOOTH 5.4 - Support for 11be 160MHz wireless standard <p>(Actual data rate may vary depending on environment and equipment.)</p> <ul style="list-style-type: none"> * Wi-Fi 7 features require Windows 11 SV3 to function properly. (There is no support driver for Windows 10.) ** Wi-Fi 7 channels on 6 GHz band availability depends on individual country's regulations.
 Expansion Slots	<ul style="list-style-type: none"> ◆ CPU: <ul style="list-style-type: none"> - 1 x PCI Express x16 slot, supporting PCIe 5.0 and running at x16 (PCIEX16) - 1 x PCI Express x16 slot, supporting PCIe 5.0 and running at x8 (PCIEX8) * The PCIEX8 slot shares bandwidth with the PCIEX16 slot. When the PCIEX8 slot is populated, the PCIEX16 slot operates at up to x8 mode. * The PCIEX16 and PCIEX8 slots can only support a graphics card or an NVMe SSD. If only one graphics card is to be installed, be sure to install it in the PCIEX16 slot. ◆ Chipset: <ul style="list-style-type: none"> - 1 x PCI Express x16 slot, supporting PCIe 4.0 and running at x4 (PCIEX4)
 Storage Interface	<ul style="list-style-type: none"> ◆ CPU: <ul style="list-style-type: none"> - 1 x M.2 connector (Socket 3, M key, type 25110/22110/2580/2280 PCIe 5.0 x4/x2 SSD support) (M2A_CPU) - 1 x M.2 connector (Socket 3, M key, type 25110/22110/2580/2280 PCIe 4.0 x4/x2 SSD support) (M2B_CPU) ◆ Chipset: <ul style="list-style-type: none"> - 1 x M.2 connector (Socket 3, M key, type 22110/2280 PCIe 4.0 x4/x2 SSD support) (M2Q_SB) - 1 x M.2 connector (Socket 3, M key, type 2280 PCIe 4.0 x4/x2 SSD support) (M2P_SB) - 1 x M.2 connector (Socket 3, M key, type 2280 SATA and PCIe 4.0 x4/x2 SSD support) (M2M_SB) - 4 x SATA 6Gb/s connectors ◆ RAID 0, RAID 1, RAID 5, and RAID 10 support for NVMe SSD storage devices ◆ RAID 0, RAID 1, RAID 5, and RAID 10 support for SATA storage devices
 USB	<ul style="list-style-type: none"> ◆ CPU: <ul style="list-style-type: none"> - 1 x USB4® USB Type-C® port on the back panel ◆ Chipset: <ul style="list-style-type: none"> - 1 x USB Type-C® port on the back panel, with USB 3.2 Gen 2x2 support - 2 x USB 3.2 Gen 2 Type-A ports (red) on the back panel - 6 x USB 3.2 Gen 1 ports (4 ports on the back panel, 2 ports available through the internal USB header) ◆ Chipset+USB 2.0 Hub: <ul style="list-style-type: none"> - 6 x USB 2.0/1.1 ports (2 ports on the back panel, 4 ports available through the internal USB headers)

	Internal Connectors	<ul style="list-style-type: none"> ◆ 1 x 24-pin ATX main power connector ◆ 2 x 8-pin ATX 12V power connectors ◆ 1 x CPU fan header ◆ 1 x CPU fan/water cooling pump header ◆ 3 x system fan headers ◆ 1 x system fan/water cooling pump header ◆ 3 x addressable RGB Gen2 LED strip headers ◆ 1 x RGB LED strip header ◆ 5 x M.2 Socket 3 connectors ◆ 4 x SATA 6Gb/s connectors ◆ 1 x front panel header ◆ 1 x front panel audio header ◆ 1 x USB Type-C® header, with USB 3.2 Gen 2x2 support ◆ 1 x USB 3.2 Gen 1 header ◆ 2 x USB 2.0/1.1 headers ◆ 1 x Trusted Platform Module header (For the GC-TPM2.0 SPI/GC-TPM2.0 SPI 2.0/GC-TPM2.0 SPI V2 module only) ◆ 1 x HDMI port ^(Note) ◆ 1 x power button ◆ 1 x reset button ◆ 1 x Q-Flash Plus button ◆ 1 x reset jumper ◆ 1 x Clear CMOS jumper
	Back Panel Connectors	<ul style="list-style-type: none"> ◆ 2 x USB 2.0/1.1 ports ◆ 1 x HDMI port ^(Note) ◆ 2 x USB 3.2 Gen 2 Type-A ports (red) ◆ 1 x Intel® Thunderbolt™ 4 connector (USB4® USB Type-C® port) ◆ 2 x RJ-45 ports ◆ 4 x USB 3.2 Gen 1 ports ◆ 2 x antenna connectors (2T2R) ◆ 2 x audio jacks ◆ 1 x optical S/PDIF Out connector
	I/O Controller	<ul style="list-style-type: none"> ◆ iTE® I/O Controller Chip
	Hardware Monitor	<ul style="list-style-type: none"> ◆ Voltage detection ◆ Temperature detection ◆ Fan speed detection ◆ Water cooling flow rate detection ◆ Fan fail warning ◆ Fan speed control <p style="margin-left: 40px;">* Whether the fan (pump) speed control function is supported will depend on the fan (pump) you install.</p>

(Note) Actual support may vary by CPU.

 BIOS	<ul style="list-style-type: none"> ◆ 1 x 256 Mbit flash ◆ Use of licensed AMI UEFI BIOS ◆ PnP 1.0a, DMI 2.7, WfM 2.0, SM BIOS 2.7, ACPI 5.0
 Unique Features	<ul style="list-style-type: none"> ◆ Support for GIGABYTE Control Center (GCC) <ul style="list-style-type: none"> * Available applications in GCC may vary by motherboard model. Supported functions of each application may also vary depending on motherboard specifications. ◆ Support for Q-Flash ◆ Support for Q-Flash Plus ◆ Support for Smart Backup
 Bundled Software	<ul style="list-style-type: none"> ◆ Norton® Internet Security (OEM version) ◆ LAN bandwidth management software
 Operating System	<ul style="list-style-type: none"> ◆ Support for Windows 11 64-bit
 Form Factor	<ul style="list-style-type: none"> ◆ ATX Form Factor; 30.5cm x 24.4cm

* GIGABYTE reserves the right to make any changes to the product specifications and product-related information without prior notice.

➤ Please visit the **SERVICE/SUPPORT Utility** page on GIGABYTE's website to download the latest version of apps.
<https://www.gigabyte.com/Support/Utility/Motherboard?m=ut>

2-3 Installing the CPU and CPU Cooler



Read the following guidelines before you begin to install the CPU:

- Make sure that the motherboard supports the CPU.
(Go to GIGABYTE's website for the latest CPU support list.)
- Always turn off the computer and unplug the power cord from the power outlet before installing the CPU to prevent hardware damage.
- Locate the pin one of the CPU. The CPU cannot be inserted if oriented incorrectly. (Or you may locate the notches on both sides of the CPU and alignment keys on the CPU socket.)
- Apply an even and thin layer of thermal grease on the surface of the CPU.
- Do not turn on the computer if the CPU cooler is not installed, otherwise overheating and damage of the CPU may occur.
- Set the CPU host frequency in accordance with the CPU specifications. It is not recommended that the system bus frequency be set beyond hardware specifications since it does not meet the standard requirements for the peripherals. If you wish to set the frequency beyond the standard specifications, please do so according to your hardware specifications including the CPU, graphics card, memory, hard drive, etc.

A. Note the CPU Orientation

Note the alignment keys on the motherboard CPU socket and the notches on the CPU.

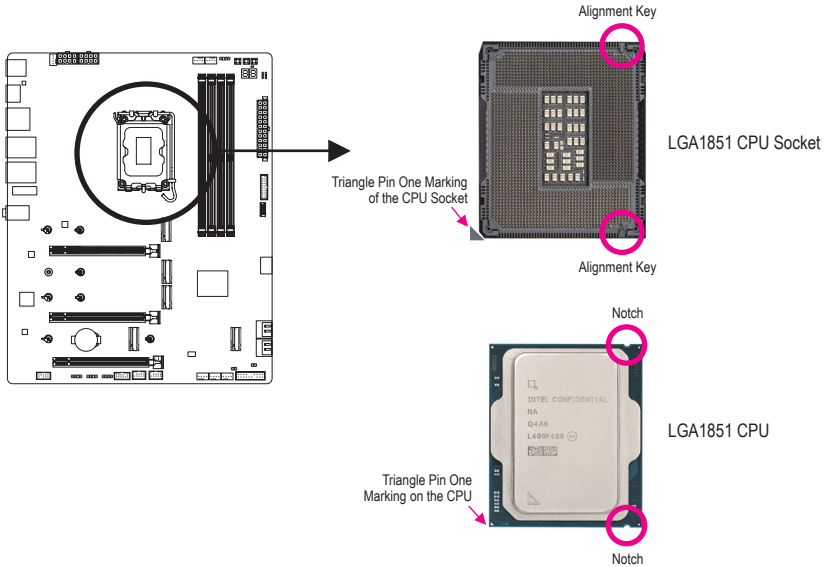

Do not remove the CPU socket cover before inserting the CPU. It may pop off from the load plate automatically after you insert the CPU and close the load plate.

☞ Please visit GIGABYTE's website for details on hardware installation.
<https://www.gigabyte.com/WebPage/210/quick-guide.html?m=sw>

B. Installing the CPU

Follow the steps below to correctly install the CPU into the motherboard CPU socket.

1

- 1 Gently press the CPU socket lever handle down and away from the socket.
- 2 Completely lift up the CPU socket locking lever.
- 3 Use the finger tab on the side of the metal load plate to lift open the metal load plate with the plastic protective cover attached to it.

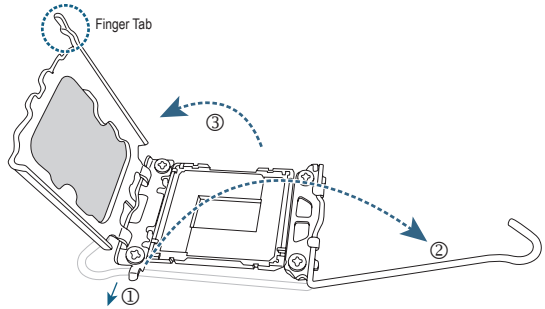

2

Hold the CPU with your fingers by the edges. Align the CPU pin one marking (triangle) with the pin one corner of the CPU socket (or you may align the CPU notches with the socket alignment keys) and gently insert the CPU into position.

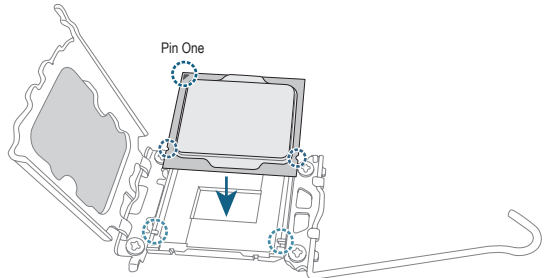

3

Make sure the CPU is properly installed and then close the load plate. The plastic protective cover will pop off, just remove it. Secure the lever under its retention tab to complete the installation of the CPU.

* Always replace the plastic protective cover when the CPU is not installed to protect the CPU socket.

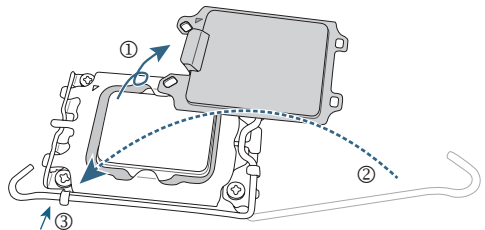

Do not force to engage the CPU socket locking lever when the CPU is not installed correctly as this would damage the CPU and CPU socket.

C. Installing the CPU Cooler

Be sure to install the CPU cooler after installing the CPU. (Actual installation process may differ depending the CPU cooler to be used. Refer to the user's manual for your CPU cooler.)

1

Apply an even and thin layer of thermal grease on the surface of the installed CPU.

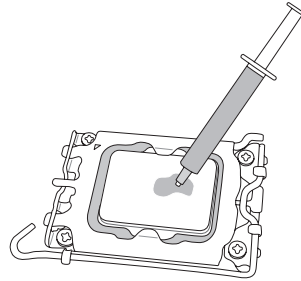

2

Place the cooler atop the CPU, aligning the four push pins through the pin holes on the motherboard. Push down on the push pins diagonally.

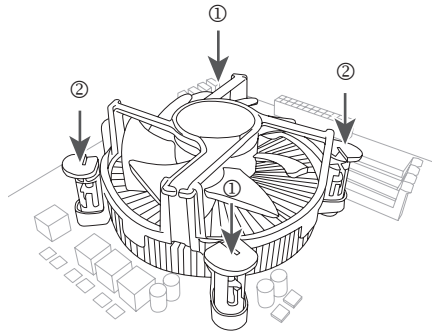

3

Finally, attach the power connector of the CPU cooler to the CPU fan header (CPU_FAN) on the motherboard.

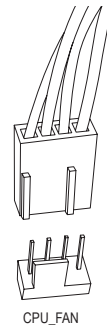

2-4 Installing the Memory



Read the following guidelines before you begin to install the memory:

- Make sure that the motherboard supports the memory. It is recommended that memory of the same capacity, brand, speed, and chips be used. (Go to GIGABYTE's website for the latest supported memory speeds and memory modules.)
- Always turn off the computer and unplug the power cord from the power outlet before installing the memory to prevent hardware damage.
- Memory modules have a foolproof design. A memory module can be installed in only one direction. If you are unable to insert the memory, switch the direction.

* Recommended Memory Configurations:

	DDR5_A1	DDR5_A2	DDR5_B1	DDR5_B2
1 Module	--	✓	--	--
1 Module	--	--	--	✓
2 Modules*	--	✓	--	✓
4 Modules*	✓	✓	✓	✓

(" ✓ " = Installed, "--" = No Memory)

(" * " = Recommended Dual Channel Memory Configurations)



The memory status LED will light up if the memory module is installed in the incorrect slot before booting. Ensure that the memory module is installed in the correct slot. Refer to the table for memory installation instructions.

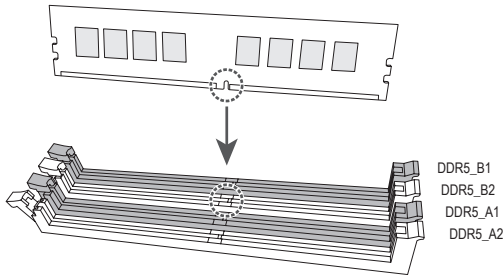

Dual Channel Memory Configuration

This motherboard provides four memory sockets and supports Dual Channel Technology. After the memory is installed, the BIOS will automatically detect the specifications and capacity of the memory. Enabling Dual Channel memory mode will double the original memory bandwidth.

The four memory sockets are divided into two channels and each channel has two memory sockets as following:

- ▶▶ Channel A: DDR5_A1, DDR5_A2
- ▶▶ Channel B: DDR5_B1, DDR5_B2

Due to CPU limitations, read the following guidelines before installing the memory in Dual Channel mode.

1. Dual Channel mode cannot be enabled if only one memory module is installed.
2. When enabling Dual Channel mode with two or four memory modules, it is recommended that memory of the same capacity, brand, speed, and chips be used.

2-5 Installing an Expansion Card



Read the following guidelines before you begin to install an expansion card:

- Make sure the motherboard supports the expansion card. Carefully read the manual that came with your expansion card.
- Always turn off the computer and unplug the power cord from the power outlet before installing an expansion card to prevent hardware damage.

Follow the steps below to correctly install your expansion card in the expansion slot.

1. Locate an expansion slot that supports your card. Remove the metal slot cover from the chassis back panel.
2. Align the card with the slot, and press down on the card until it is fully seated in the slot.
3. Make sure that the expansion card is fully seated in its slot.
4. Secure the card's metal bracket to the chassis back panel with a screw.
5. After installing all expansion cards, replace the chassis cover(s).
6. Turn on your computer. If necessary, go to BIOS Setup to make any required BIOS changes for your expansion card(s).
7. Install the driver provided with the expansion card in your operating system.

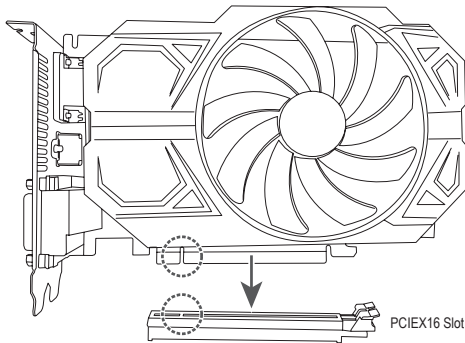

➤ Please visit GIGABYTE's website for details on using PCIe EZ-Latch Plus.
<https://www.gigabyte.com/WebPage/922/removePCIe.html>

2-6 Back Panel Connectors

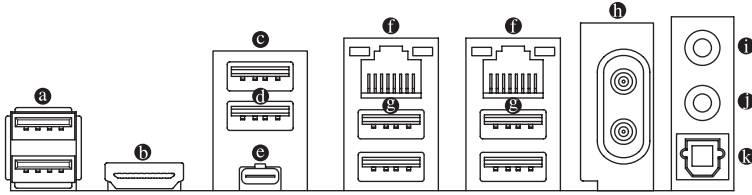

a USB 2.0/1.1 Port

The USB port supports the USB 2.0/1.1 specification. Use this port for USB devices.

b HDMI Port (Note 2)



The HDMI port is HDCP 2.3 compliant and supports Dolby TrueHD and DTS HD Master Audio formats. It also supports up to 192KHz/24bit 7.1-channel LPCM audio output. You can use this port to connect your HDMI-supported monitor. The maximum supported resolution is 4096x2160@60 Hz, but the actual resolutions supported are dependent on the monitor being used.



After installing the HDMI device, make sure to set the default sound playback device to HDMI. (The item name may differ depending on your operating system.)

c USB 3.2 Gen 2 Type-A Port (Red)

The USB 3.2 Gen 2 port supports the USB 3.2 Gen 2 specification and is compatible to the USB 3.2 Gen 1 and USB 2.0 specification. Use this port for USB devices.

d USB 3.2 Gen 2 Type-A Port (Red) (Q-Flash Plus Port)

The USB 3.2 Gen 2 port supports the USB 3.2 Gen 2 specification and is compatible to the USB 3.2 Gen 1 and USB 2.0 specification. Use this port for USB devices. Before using Q-Flash Plus (Note 1), make sure to insert the USB flash drive into this port first.

e Thunderbolt™ 4 Connector (USB4® USB Type-C® Port)

The connector supports standard DisplayPort and Thunderbolt™ video outputs (Note 2). You can connect a standard DisplayPort/Thunderbolt™ monitor to this connector with an adapter. The Thunderbolt™ connector can daisy chain up to five Thunderbolt™ devices. Because of the limited I/O resources of the PC architecture, the number of Thunderbolt™ devices that can be used is dependent on the number of the PCI Express devices being installed. You can adjust the Thunderbolt™ settings under Settings\Thunderbolt Configuration in BIOS Setup. The maximum supported resolution is 5120x2880@60 Hz with 24 bpp via single display output, but the actual resolutions supported are dependent on the monitor being used. Also, the connector is reversible and supports the USB4® specification and is compatible to the USB 3.2 Gen 2x2, USB 3.2 Gen 2, USB 3.2 Gen 1, and USB 2.0 specifications. Use this port for USB devices.

f RJ-45 LAN Port

The Gigabit Ethernet LAN port provides Internet connection at up to 2.5 Gbps data rate. The following describes the states of the LAN port LEDs.

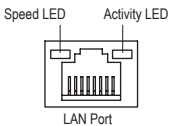

Speed LED:	
State	Description
Green	2.5 Gbps data rate
Orange	1 Gbps data rate
Off	100 Mbps data rate

Activity LED:	
State	Description
Blinking	Data transmission or receiving is occurring
On	No data transmission or receiving is occurring

(Note 1) To enable the Q-Flash Plus function, please navigate to the "Unique Features" page of GIGABYTE's website for more information.

(Note 2) Actual support may vary by CPU.

⑨ USB 3.2 Gen 1 Port

The USB 3.2 Gen 1 port supports the USB 3.2 Gen 1 specification and is compatible to the USB 2.0 specification. Use this port for USB devices.

⑩ Antenna Connectors (2T2R)

Use this connector to connect an antenna.



Ensure the antenna is securely connected to the antenna connectors and then aim the antennas correctly for better signal reception.

⑪ Line Out/Front Speaker Out

The line out jack.

⑫ Mic In/Rear Speaker Out

The Mic in jack.

⑬ Optical S/PDIF Out Connector

This connector provides digital audio out to an external audio system that supports digital optical audio. Before using this feature, ensure that your audio system provides an optical digital audio in connector.

Audio Jack Configurations:

Jack	Headphone/ 2-channel	4-channel	5.1-channel	7.1-channel
⑪ Line Out/Front Speaker Out	✓	✓	✓	✓
⑫ Mic In/Rear Speaker Out		✓	✓	✓
Front Panel Line Out/Side Speaker Out				✓
Front Panel Mic In/Center/Subwoofer Speaker Out			✓	✓



You can change the functionality of an audio jack using the audio software. To configure 7.1-channel audio, access the audio software for audio settings.

☞ Please visit GIGABYTE's website for details on configuring the audio software.

<https://www.gigabyte.com/WebPage/698/realtek1220-audio.html>



- When removing the cable connected to a back panel connector, first remove the cable from your device and then remove it from the motherboard.
- When removing the cable, pull it straight out from the connector. Do not rock it side to side to prevent an electrical short inside the cable connector.

2-7 Onboard Buttons and LEDs

Quick Buttons

This motherboard has 2 quick buttons: power button and reset button. The power button and reset button allow users to quickly turn on/off or reset the computer in an open-case environment when they want to change hardware components or conduct hardware testing.

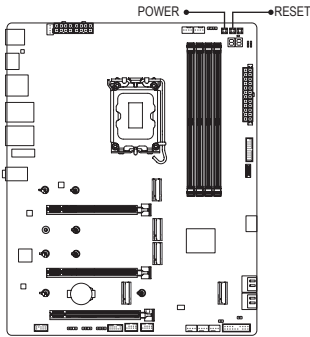

POWER: Power Button
RESET: Reset Button



The reset button provides you with several functions to use. To remap the button to perform different tasks, please navigate to the "BIOS Setup" page of GIGABYTE's website and search for "RST (MULTIKEY)" for more information.

QF_PLUS (Q-Flash Plus Button)

Q-Flash Plus allows you to update the BIOS when your system is off (S5 shutdown state). Save the latest BIOS on a USB thumb drive and plug it into the dedicated port, and then you can now flash the BIOS automatically by simply pressing the Q-Flash Plus button. The QFLED will flash when the BIOS matching and flashing activities start and will stop flashing when the main BIOS flashing is complete.

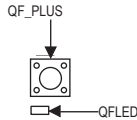
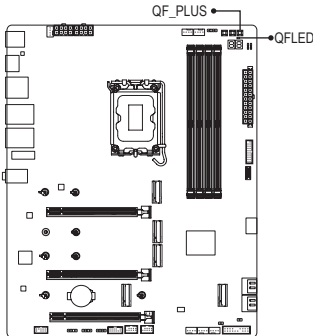

To enable the Q-Flash Plus function, please navigate to the "Unique Features" page of GIGABYTE's website for more information.

Status LEDs

The status LEDs show whether the CPU, memory, graphics card, and operating system are working properly after system power-on. If the CPU/DRAM/VGA LED is on, that means the corresponding device is not working normally; if the BOOT LED is on, that means you haven't entered the operating system yet.

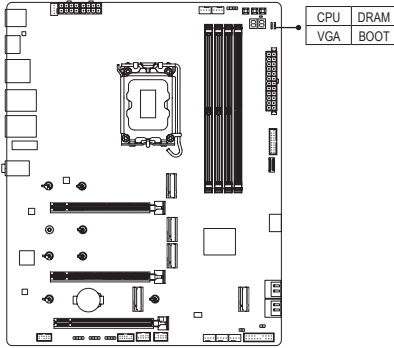

- CPU:** CPU status LED
- DRAM:** Memory status LED
- VGA:** Graphics card status LED
- BOOT:** Operating system status LED

2-8 Internal Connectors

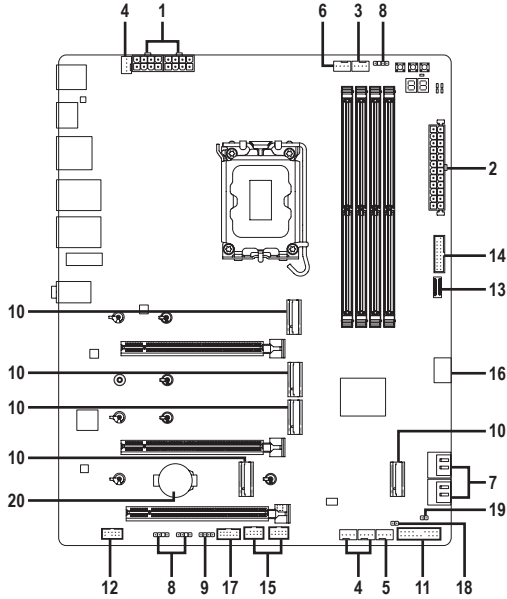

1) 12V_2X4_1/12V_2X4_2	11) F_PANEL
2) ATX	12) F_AUDIO
3) CPU_FAN	13) FU3C_20G
4) SYS_FAN1/2/3	14) FU3A_5G
5) FAN4_PUMP	15) FUSB_1/FUSB_2
6) CPU_OPT	16) F_HDMI
7) SATA3 4/5/6/7	17) SPI_TPM
8) ARGB_V2_1/ARGB_V2_2/ARGB_V2_3	18) CLR_CMOS
9) LED_C	19) RST
10) M2A_CPU/M2B_CPU/M2Q_SB/M2P_SB/M2M_SB	20) BAT



Read the following guidelines before connecting external devices:

- First make sure your devices are compliant with the connectors you wish to connect.
- Before installing the devices, be sure to turn off the devices and your computer. Unplug the power cord from the power outlet to prevent damage to the devices.
- After installing the device and before turning on the computer, make sure the device cable has been securely attached to the connector on the motherboard.

1/2) 12V_2X4_1/12V_2X4_2/ATX (2x4 12V Power Connectors and 2x12 Main Power Connector)

With the use of the power connector, the power supply can supply enough stable power to all the components on the motherboard. Before connecting the power connector, first make sure the power supply is turned off and all devices are properly installed. The power connector possesses a foolproof design. Connect the power supply cable to the power connector in the correct orientation.

The 12V power connector mainly supplies power to the CPU. If the 12V power connector is not connected, the computer will not start.



To meet expansion requirements, it is recommended that a power supply that can withstand high power consumption be used (500W or greater). If a power supply that does not provide the required power is used, it can result in an unstable or unbootable system.

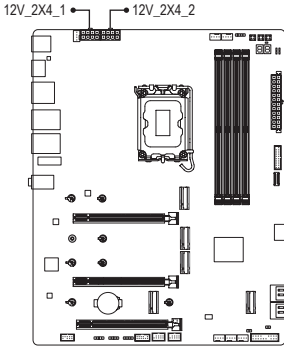

12V_2X4_1/12V_2X4_2:

Pin No.	Definition
1	GND (Only for 2x4-pin 12V)
2	GND (Only for 2x4-pin 12V)
3	GND
4	GND
5	+12V (Only for 2x4-pin 12V)
6	+12V (Only for 2x4-pin 12V)
7	+12V
8	+12V

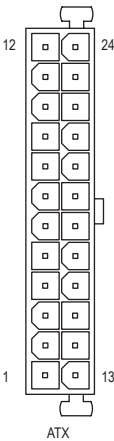

ATX:

Pin No.	Definition	Pin No.	Definition
1	3.3V	13	3.3V
2	3.3V	14	-12V
3	GND	15	GND
4	+5V	16	PS_ON (soft On/Off)
5	GND	17	GND
6	+5V	18	GND
7	GND	19	GND
8	Power Good	20	NC
9	5VSB (stand by +5V)	21	+5V
10	+12V	22	+5V
11	+12V (Only for 2x12-pin ATX)	23	+5V (Only for 2x12-pin ATX)
12	3.3V (Only for 2x12-pin ATX)	24	GND (Only for 2x12-pin ATX)

3/4) CPU_FAN/SYS_FAN1/2/3 (Fan Headers)

All fan headers on this motherboard are 4-pin. Most fan headers possess a foolproof insertion design. When connecting a fan cable, be sure to connect it in the correct orientation (the black connector wire is the ground wire). The speed control function requires the use of a fan with fan speed control design. For optimum heat dissipation, it is recommended that a system fan be installed inside the chassis.

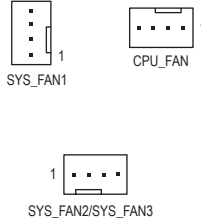
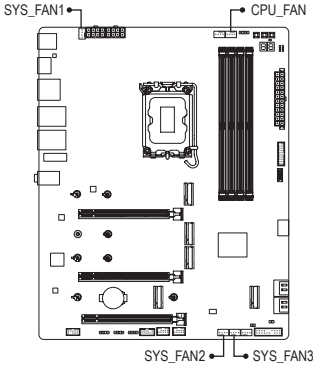

Pin No.	Definition
1	GND
2	Voltage Speed Control
3	Sense
4	PWM Speed Control

5) FAN4_PUMP (System Fan/Water Cooling Pump Header)

The fan/pump header is 4-pin and possesses a foolproof insertion design. Most fan headers possess a foolproof insertion design. When connecting a fan cable, be sure to connect it in the correct orientation (the black connector wire is the ground wire). The speed control function requires the use of a fan with fan speed control design. For optimum heat dissipation, it is recommended that a system fan be installed inside the chassis. The header also provides speed control for a water cooling pump. Please navigate to the "BIOS Setup" page of GIGABYTE's website and search for "Smart Fan 6" for more information.

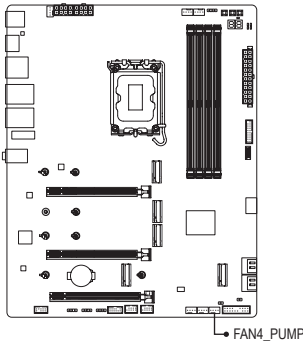

Pin No.	Definition
1	GND
2	Voltage Speed Control
3	Sense
4	PWM Speed Control



- Be sure to connect fan cables to the fan headers to prevent your CPU and system from overheating. Overheating may result in damage to the CPU or the system may hang.
- These fan headers are not configuration jumper blocks. Do not place a jumper cap on the headers.

6) CPU_OPT (CPU Fan/Water Cooling Pump Header)

The fan/pump header is 4-pin and possesses a foolproof insertion design. Most fan headers possess a foolproof insertion design. When connecting a fan cable, be sure to connect it in the correct orientation (the black connector wire is the ground wire). The speed control function requires the use of a fan with fan speed control design.

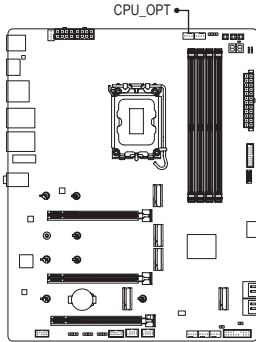

Pin No.	Definition
1	GND
2	Voltage Speed Control
3	Sense
4	PWM Speed Control

Connector	CPU_FAN	SYS_FAN1~3	FAN4_PUMP	CPU_OPT
Maximum Current	2A	2A	2A	2A
Maximum Power	24W	24W	24W	24W

7) SATA3 4/5/6/7 (SATA 6Gb/s Connectors)

The SATA connectors conform to SATA 6Gb/s standard and are compatible with SATA 3Gb/s and SATA 1.5Gb/s standard. Each SATA connector supports a single SATA device. The SATA connectors support RAID 0, RAID 1, RAID 5, and RAID 10. Please navigate to the "Configuring a RAID Set" page of GIGABYTE's website for instructions on configuring a RAID array.

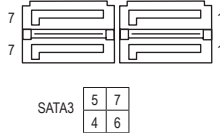
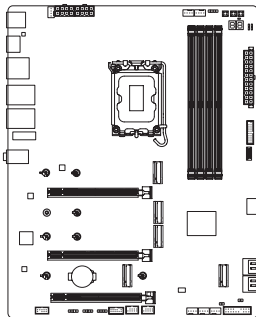

Pin No.	Definition
1	GND
2	TXP
3	TXN
4	GND
5	RXN
6	RXP
7	GND



To enable hot-plugging for the SATA ports, please navigate to the "BIOS Setup" page of GIGABYTE's website and search for "SATA Configuration" for more information.

8) ARGB_V2_1/ARGB_V2_2/ARGB_V2_3 (Addressable RGB Gen2 LED Strip Headers)

The headers can be used to connect a standard 5050 addressable RGB Gen2 LED strip, with maximum power rating of 3A (5V) and maximum number of 256 LEDs.

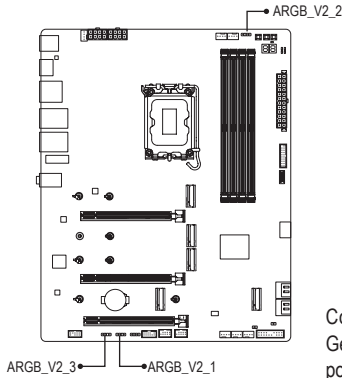

Pin No.	Definition
1	V (5V)
2	Data
3	No Pin
4	GND

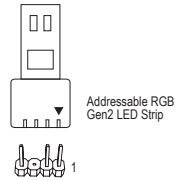

Connect your addressable RGB Gen2 LED strip to the header. The power pin (marked with a triangle on the plug) of the LED strip must be connected to Pin 1 of the addressable LED strip header. Incorrect connection may lead to the damage of the LED strip.

9) LED_C (RGB LED Strip Header)

The header can be used to connect a standard 5050 RGB LED strip (12V/G/R/B), with maximum power rating of 2A (12V) and maximum length of 2m.

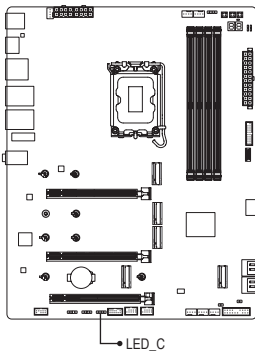

Pin No.	Definition
1	12V
2	G
3	R
4	B

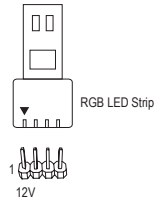

Connect your RGB LED strip to the header. The power pin (marked with a triangle on the plug) of the LED strip must be connected to Pin 1 (12V) of this header. Incorrect connection may lead to the damage of the LED strip.



For how to turn on/off the lights of the LED strip, please navigate to the "Unique Features" page of GIGABYTE's website.



- To avoid abnormal LED behavior, do not connect addressable RGB Gen1 LED strips and addressable RGB Gen2 LED strips to the same header at the same time.
- Before installing or removing the devices, be sure to turn off the devices and your computer. Unplug the power cord from the power outlet to prevent damage to the devices.

10) M2A_CPU/M2B_CPU/M2Q_SB/M2P_SB/M2M_SB (M.2 Socket 3 Connectors)

There are two types of M.2 SSDs: M.2 SATA SSDs and M.2 PCIe SSDs. Be sure to verify which type of M.2 SSDs is supported by the M.2 socket you want to use. Please note that an M.2 PCIe SSD cannot be used to create a RAID set either with an M.2 SATA SSD or a SATA hard drive. Please navigate to the "Configuring a RAID Set" page of GIGABYTE's website for instructions on configuring a RAID array.

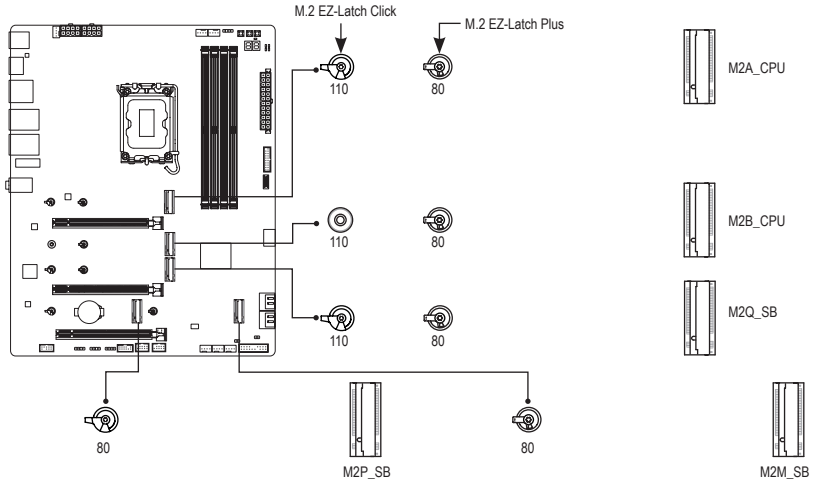

- **Installing the M.2 thermal pad (applicable only for M.2 connectors with pre-installed thermal pads):**
When using a single-sided M.2 SSD, first attach the bundled M.2 thermal pad to the pre-installed thermal pad on the M.2 connector before installing the M.2 SSD.



Do not install the bundled M.2 thermal pad when using a double-sided M.2 SSD.

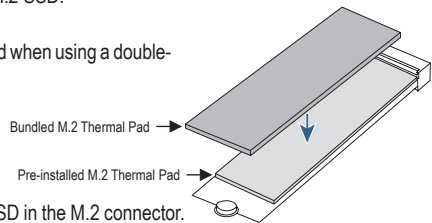

Follow the steps below to correctly install an M.2 SSD in the M.2 connector.

- **M2A_CPU/M2B_CPU/M2Q_SB:**

Step 1: Turn the M.2 EZ-Latch Click clip clockwise and remove the motherboard heatsink. Locate the proper mounting hole for the M.2 SSD to be installed and secure the M.2 EZ-Latch Plus clip in the hole first (For M2B_CPU connector.)



If you want to install an M.2 SSD in the 110mm hole, remove the EZ-Latch Plus clip from the 80mm hole first.

Step 2: Remove the protective film from the thermal pad (only the M2A_CPU connector has the thermal pad) on the M.2 connector. Insert the M.2 SSD into the M.2 connector at an angle.



If you wish to replace the thermal pad, it is recommended to use one with a thickness of 1.25mm.

Step 3: Press down on the front end of the M.2 SSD and make sure the M.2 SSD is secured by the clip. Remove the protective film from the bottom of the motherboard heatsink, and finally, turn the M.2 EZ-Latch Click clip clockwise and then install the heatsink back in place.

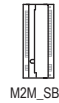
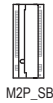

• **Installing the M.2 rubber pad (applicable only for M.2 connectors without pre-installed thermal pads):**

- a. When using a double-sided M.2 SSD, attach the thick rubber pad to the recommended placement area as shown below.
- b. When using a single-sided M.2 SSD, first stick the thin rubber pad to the thick rubber pad, and then attach them to the recommended placement area as shown below.

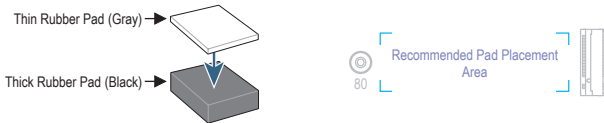

Avoid contacting any chips or IC components on the motherboard when attaching the rubber pads.

• **M2P_SB/M2M_SB:**

Step 1:

Turn the M.2 EZ-Latch Click clip clockwise and remove the motherboard heatsink.

Step 2:

Insert the M.2 SSD into the M.2 connector at an angle. Press down on the front end of the M.2 SSD and make sure the M.2 SSD is secured by the clip.

Step 3:

Remove the protective film from the bottom of the motherboard heatsink, and finally, turn the M.2 EZ-Latch Click clip clockwise and then install the heatsink back in place.

* Types of M.2 SSDs supported by each M.2 connector:

	M.2 PCIe x4 SSD	M.2 PCIe x2 SSD	M.2 SATA SSD
M2A_CPU	✓	✓	✗
M2B_CPU	✓	✓	✗
M2Q_SB	✓	✓	✗
M2P_SB	✓	✓	✗
M2M_SB	✓	✓	✓



Please visit GIGABYTE's website for details on using M.2 EZ-Latch Click/M.2 EZ-Latch Plus.

M.2 SSD installation with M.2 EZ-Latch Click: <https://www.gigabyte.com/WebPage/1048/M.2-EZ-Latch-Click.html>

M.2 SSD installation with M.2 EZ-Latch Plus: <https://www.gigabyte.com/WebPage/920/M2-latchplus.html>

M.2 SSD removal with M.2 EZ-Latch Plus: <https://www.gigabyte.com/WebPage/921/removeM2.html>

* Motherboard heatsink design may vary by model.

11) F_PANEL (Front Panel Header)

Connect the power switch, reset switch, speaker, chassis intrusion switch/sensor and system status indicator on the chassis to this header according to the pin assignments below. Note the positive and negative pins before connecting the cables.

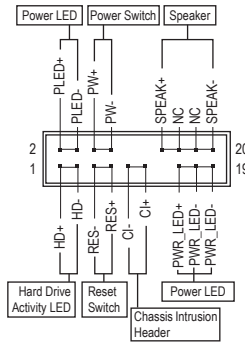
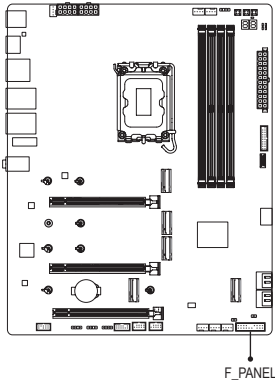

- **PLED/PWR_LED (Power LED):**

System Status	LED
S0	On
S3/S4/S5	Off

Connects to the power status indicator on the chassis front panel. The LED is on when the system is operating. The LED is off when the system is in S3/S4 sleep state or powered off (S5).

- **PW (Power Switch):**

Connects to the power switch on the chassis front panel. You may configure the way to turn off your system using the power switch (please navigate to the "BIOS Setup" page of GIGABYTE's website and search for "Soft-Off by PWR-BTTN" for more information).

- **SPEAK (Speaker):**

Connects to the speaker on the chassis front panel. The system reports system startup status by issuing a beep code. One single short beep will be heard if no problem is detected at system startup.

- **HD (Hard Drive Activity LED):**

Connects to the hard drive activity LED on the chassis front panel. The LED is on when the hard drive is reading or writing data.

- **RES (Reset Switch):**

Connects to the reset switch on the chassis front panel. Press the reset switch to restart the computer if the computer freezes and fails to perform a normal restart.

- **CI (Chassis Intrusion Header):**

Connects to the chassis intrusion switch/sensor on the chassis that can detect if the chassis cover has been removed. This function requires a chassis with a chassis intrusion switch/sensor.

- **NC: No Connection.**



The front panel design may differ by chassis. A front panel module mainly consists of power switch, reset switch, power LED, hard drive activity LED, speaker and etc. When connecting your chassis front panel module to this header, make sure the wire assignments and the pin assignments are matched correctly.

12) F_AUDIO (Front Panel Audio Header)

The front panel audio header supports High Definition audio (HD). You may connect your chassis front panel audio module to this header. Make sure the wire assignments of the module connector match the pin assignments of the motherboard header. Incorrect connection between the module connector and the motherboard header will make the device unable to work or even damage it.

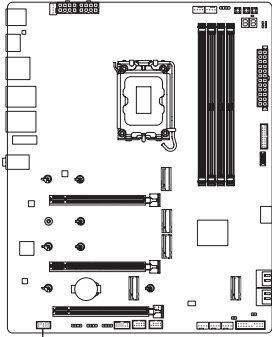

F_AUDIO



Pin No.	Definition
1	MIC L
2	GND
3	MIC R
4	NC
5	Head Phone R
6	MIC Detection
7	SENSE_SEND
8	No Pin
9	Head Phone L
10	Head Phone Detection



Some chassis provide a front panel audio module that has separated connectors on each wire instead of a single plug. For information about connecting the front panel audio module that has different wire assignments, please contact the chassis manufacturer.

13) FU3C_20G (USB Type-C® Header, with USB 3.2 Gen 2x2 Support)

The header conforms to USB 3.2 Gen 2x2 specification and can provide one USB port.

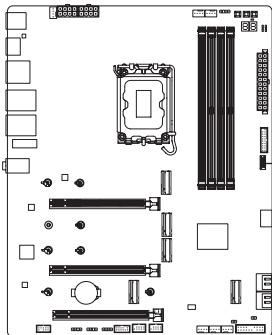

FU3C_20G



Pin No.	Definition	Pin No.	Definition
1	VBUS	11	VBUS
2	TX1+	12	TX2+
3	TX1-	13	TX2-
4	GND	14	GND
5	RX1+	15	RX2+
6	RX1-	16	RX2-
7	VBUS	17	GND
8	CC1	18	D-
9	SBU1	19	D+
10	SBU2	20	CC2

14) FU3A_5G (USB 3.2 Gen 1 Header)

The header conforms to USB 3.2 Gen 1 and USB 2.0 specification and can provide two USB ports. For purchasing the optional 3.5" front panel that provides two USB 3.2 Gen 1 ports, please contact the local dealer.

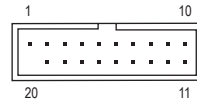
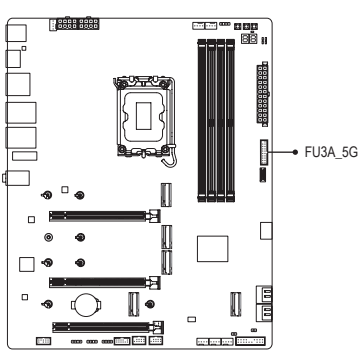

Pin No.	Definition	Pin No.	Definition
1	VBUS	11	D2+
2	SSRX1-	12	D2-
3	SSRX1+	13	GND
4	GND	14	SSTX2+
5	SSTX1-	15	SSTX2-
6	SSTX1+	16	GND
7	GND	17	SSRX2+
8	D1-	18	SSRX2-
9	D1+	19	VBUS
10	NC	20	No Pin

15) FUSB_1/FUSB_2 (USB 2.0/1.1 Headers)

The headers conform to USB 2.0/1.1 specification. Each USB header can provide two USB ports via an optional USB bracket. For purchasing the optional USB bracket, please contact the local dealer.

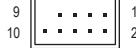
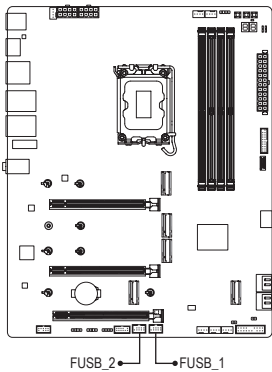

Pin No.	Definition
1	Power (5V)
2	Power (5V)
3	USB DX-
4	USB DY-
5	USB DX+
6	USB DY+
7	GND
8	GND
9	No Pin
10	NC



Prior to installing the USB bracket, be sure to turn off your computer and unplug the power cord from the power outlet to prevent damage to the USB bracket.

16) F_HDMI (HDMI Port) (Note)

This port supports HDMI display output, allowing you to connect a display screen inside a computer case. It can support a display screen with a maximum resolution of 1920x1080@30 Hz. The actual supported resolution may vary depending on the display screen you use. For instructions on how to connect a display screen inside your computer case, please refer to the user manual of the display screen.

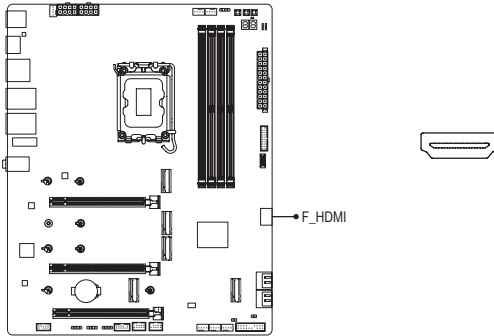

17) SPI_TPM (Trusted Platform Module Header)

You may connect an SPI TPM (Trusted Platform Module) to this header.

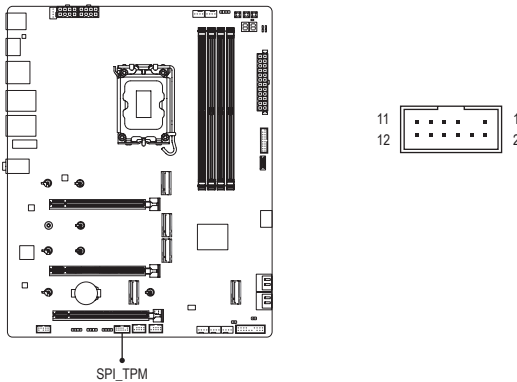



Pin No.	Definition
1	Data Output
2	Power (3.3V)
3	No Pin
4	NC
5	Data Input
6	CLK
7	Chip Select
8	GND
9	IRQ
10	NC
11	NC
12	RST

(Note) Actual support may vary by CPU.

18) CLR_CMOS (Clear CMOS Jumper)

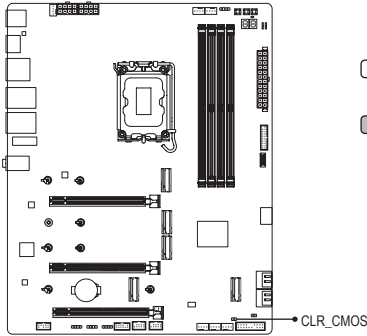
Use this jumper to clear the BIOS configuration and reset the CMOS values to factory defaults. To clear the CMOS values, use a metal object like a screwdriver to touch the two pins for a few seconds.



-  Open: Normal
-  Short: Clear CMOS Values



- Always turn off your computer and unplug the power cord from the power outlet before clearing the CMOS values.
- After system restart, go to BIOS Setup to load factory defaults (select Load Optimized Defaults) or manually configure the BIOS settings (please navigate to the "BIOS Setup" page of GIGABYTE's website for more information).

19) RST (Reset Jumper)

The reset jumper can connect to the reset switch on the chassis front panel. Press the reset switch to restart the computer if the computer freezes and fails to perform a normal restart.

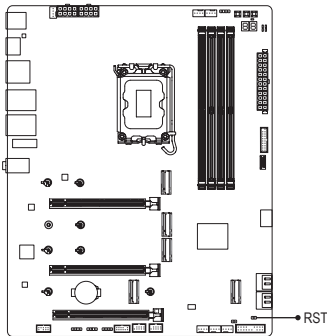

Pin No.	Definition
1	Reset
2	GND



The reset jumper provides you with several functions to use. To remap the button to perform different tasks, please navigate to the "BIOS Setup" page of GIGABYTE's website and search for "RST (MULTIKEY)" for more information.

20) BAT (Battery)

The battery provides power to keep the values (such as BIOS configurations, date, and time information) in the CMOS when the computer is turned off. Replace the battery when the battery voltage drops to a low level, or the CMOS values may not be accurate or may be lost.

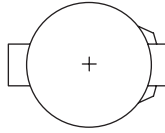
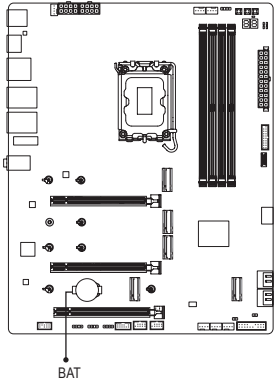

You may clear the CMOS values by removing the battery:

1. Turn off your computer and unplug the power cord.
2. Gently remove the battery from the battery holder and wait for one minute. (Or use a metal object like a screwdriver to touch the positive and negative terminals of the battery holder, making them short for 5 seconds.)
3. Replace the battery.
4. Plug in the power cord and restart your computer.



- Always turn off your computer and unplug the power cord before replacing the battery.
- Replace the battery with an equivalent one. Damage to your devices may occur if the battery is replaced with an incorrect model.
- Contact the place of purchase or local dealer if you are not able to replace the battery by yourself or uncertain about the battery model.
- When installing the battery, note the orientation of the positive side (+) and the negative side (-) of the battery (the positive side should face up).
- Used batteries must be handled in accordance with local environmental regulations.

Chapter 3 BIOS Setup

BIOS (Basic Input and Output System) records hardware parameters of the system in the CMOS on the motherboard. Its major functions include conducting the Power-On Self-Test (POST) during system startup, saving system parameters and loading operating system, etc. BIOS includes a BIOS Setup program that allows the user to modify basic system configuration settings or to activate certain system features.

When the power is turned off, the battery on the motherboard supplies the necessary power to the CMOS to keep the configuration values in the CMOS.

To access the BIOS Setup program, press the <Delete> key during the POST when the power is turned on.

To upgrade the BIOS, use either the GIGABYTE Q-Flash or Q-Flash Plus utility.

- Q-Flash allows the user to quickly and easily upgrade or back up BIOS without entering the operating system.
- Q-Flash Plus allows you to update the BIOS when your system is off (S5 shutdown state). Save the latest BIOS on a USB thumb drive and plug it into the dedicated port, and then you can now flash the BIOS automatically by simply pressing the Q-Flash Plus button.

For instructions on using the Q-Flash and Q-Flash Plus utilities, please navigate to the "Unique Features" page of GIGABYTE's website and search for "BIOS Update Utilities."



- Because BIOS flashing is potentially risky, if you do not encounter problems using the current version of BIOS, it is recommended that you not flash the BIOS. To flash the BIOS, do it with caution. Inadequate BIOS flashing may result in system malfunction.
- It is recommended that you not alter the default settings (unless you need to) to prevent system instability or other unexpected results. Inadequately altering the settings may result in system's failure to boot. If this occurs, try to clear the CMOS values and reset the board to default values.
- Refer to the introductions of the battery/clear CMOS jumper in Chapter 2 or navigate to the "BIOS Setup" page of GIGABYTE's website and search for "Load Optimized Defaults" for how to clear the CMOS values.

➤ Please visit GIGABYTE's website for details on configuring BIOS Setup.
<https://www.gigabyte.com/WebPage/1091/intel800-bios.html>

Startup Screen:

The following startup Logo screen will appear when the computer boots.



Function Keys:

: BIOS SETUP|Q-FLASH

Press the <Delete> key to enter BIOS Setup or to access the Q-Flash utility in BIOS Setup.

<F12>: BOOT MENU

Boot Menu allows you to set the first boot device without entering BIOS Setup. In Boot Menu, use the up arrow key <↑> or the down arrow key <↓> to select the first boot device, then press <Enter> to accept. The system will boot from the device immediately.

Note: The setting in Boot Menu is effective for one time only. After system restart, the device boot order will still be based on BIOS Setup settings.

<END>: Q-FLASH

Press the <End> key to access the Q-Flash utility directly without having to enter BIOS Setup first.

Chapter 4 Installing the Operating System and Drivers

4-1 Operating System Installation

With the correct BIOS settings, you are ready to install the operating system.

To install an operating system on a RAID volume, you need to install the Intel® RST VMD Controller driver first during the OS installation process. Refer to the steps below:

Step 1:

Go to GIGABYTE's website, browse to the motherboard model's web page, download the Intel SATA Preinstall driver file on the Support\Download\SATA RAID/AHCI page, unzip the file and copy the files to your USB thumb drive.

Step 2:

Boot from the Windows setup disc and perform standard OS installation steps. When the screen requesting you to load the driver appears, select **Browse**.

Step 3:

Insert the USB thumb drive and then browse to the location of the driver. When a screen as shown below appears, select **Intel RST VMD Controller** and click **Next** to load the driver and continue the OS installation.

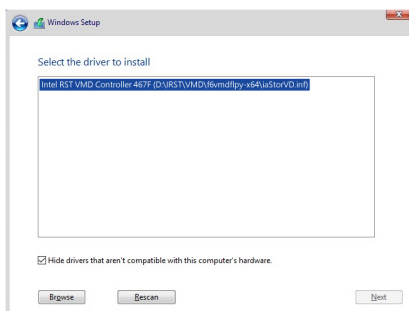

4-2 Drivers Installation

After you install the operating system, a dialog box will appear on the bottom-right corner of the desktop asking if you want to download and install the drivers and GIGABYTE applications via GIGABYTE Control Center (GCC). Click **Install** to proceed with the installation. (In BIOS Setup, make sure **Settings\IO Ports\Gigabyte Utilities Downloader Configuration\Gigabyte Utilities Downloader** is set to **Enabled**.)

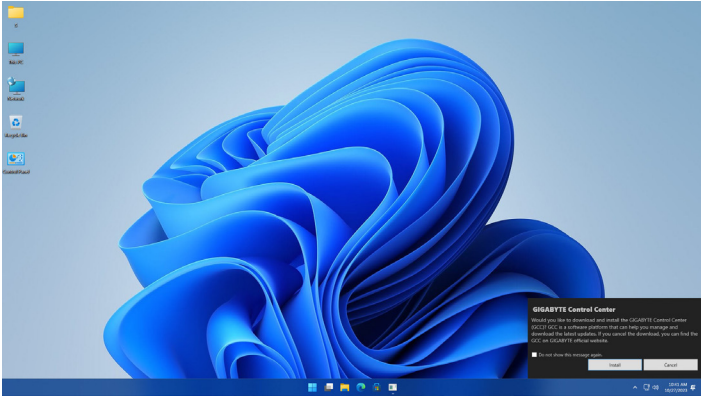

When the EULA (End User License Agreement) dialog box appears, press <Accept> to install GIGABYTE Control Center (GCC). On the GIGABYTE CONTROL CENTER screen, select the drivers and applications you want to install and click **Install**.

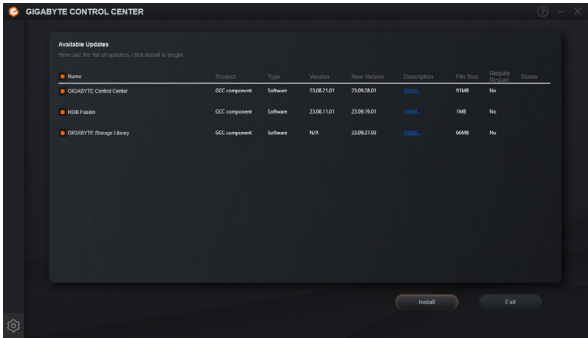

Before the installation, make sure the system is connected to the Internet.

- ⊞ Please visit GIGABYTE's website for more software information.
<https://www.gigabyte.com/WebPage/1089/intel800-app.html>
- ⊞ Please visit GIGABYTE's website for more troubleshooting information.
<https://www.gigabyte.com/WebPage/351/faq.html>

Chapter 5 Appendix

5-1 Configuring a RAID Set

RAID Levels

	RAID 0	RAID 1	RAID 5	RAID 10
Minimum Number of Hard Drives	≥2	2	≥3	4
Array Capacity	Number of hard drives * Size of the smallest drive	Size of the smallest drive	(Number of hard drives - 1) * Size of the smallest drive	(Number of hard drives/2) * Size of the smallest drive
Fault Tolerance	No	Yes	Yes	Yes

Before you begin, please prepare the following items:

This motherboard supports RAID 0, RAID 1, RAID 5, and RAID 10. Prepare the correct number of hard drives as indicated in the table above before configuring a RAID array.

- SATA hard drives or SSDs. To ensure optimal performance, it is recommended that you use two hard drives with identical model and capacity.
- Windows setup disc.
- An Internet connected computer.
- A USB thumb drive.



An M.2 PCIe SSD cannot be used to set up a RAID set either with an M.2 SATA SSD or a SATA hard drive.

☞ Please visit GIGABYTE's website for details on configuring a RAID array.

<https://www.gigabyte.com/WebPage/1090/intel800-raid.html>

5-2 Debug LED Codes

Regular Boot

Code	Description
10	PEI Core is started.
11	Pre-memory CPU initialization is started.
12~14	Reserved.
15	Pre-memory North-Bridge initialization is started.
16~18	Reserved.
19	Pre-memory South-Bridge initialization is started.
1A~2A	Reserved.
2B~2F	Memory initialization.
31	Memory installed.
32~36	CPU PEI initialization.
37~3A	IOH PEI initialization.
3B~3E	PCH PEI initialization.
3F~4F	Reserved.
60	DXE Core is started.
61	NVRAM initialization.
62	Installation of the PCH runtime services.
63~67	CPU DXE initialization is started.
68	PCI host bridge initialization is started.
69	IOH DXE initialization.
6A	IOH SMM initialization.
6B~6F	Reserved.
70	PCH DXE initialization.
71	PCH SMM initialization.
72	PCH devices initialization.
73~77	PCH DXE initialization (PCH module specific).
78	ACPI Core initialization.
79	CSM initialization is started.
7A~7F	Reserved for AML use.
80~8F	Reserved for OEM use (OEM DXE initialization codes).
90	Phase transfer to BDS (Boot Device Selection) from DXE.
91	Issue event to connect drivers.

Code	Description
92	PCI Bus initialization is started.
93	PCI Bus hot plug initialization.
94	PCI Bus enumeration for detecting how many resources are requested.
95	Check PCI device requested resources.
96	Assign PCI device resources.
97	Console Output devices connect (ex. Monitor is lighted).
98	Console input devices connect (ex. PS2/USB keyboard/mouse are activated).
99	Super IO initialization.
9A	USB initialization is started.
9B	Issue reset during USB initialization process.
9C	Detect and install all currently connected USB devices.
9D	Activated all currently connected USB devices.
9E~9F	Reserved.
A0	IDE initialization is started.
A1	Issue reset during IDE initialization process.
A2	Detect and install all currently connected IDE devices.
A3	Activated all currently connected IDE devices.
A4	SCSI initialization is started.
A5	Issue reset during SCSI initialization process.
A6	Detect and install all currently connected SCSI devices.
A7	Activated all currently connected SCSI devices.
A8	Verify password if needed.
A9	BIOS Setup is started.
AA	Reserved.
AB	Wait user command in BIOS Setup.
AC	Reserved.
AD	Issue Ready To Boot event for OS Boot.
AE	Boot to Legacy OS.
AF	Exit Boot Services.
B0	Runtime AP installation begins.
B1	Runtime AP installation ends.
B2	Legacy Option ROM initialization.
B3	System reset if needed.

Code	Description
B4	USB device hot plug-in.
B5	PCI device hot plug.
B6	Clean-up of NVRAM.
B7	Reconfigure NVRAM settings.
B8~BF	Reserved.
C0~CF	Reserved.

S3 Resume

Code	Description
E0	S3 Resume is stored (called from DXE IPL).
E1	Fill boot script data for S3 resume.
E2	Initializes VGA for S3 resume.
E3	OS S3 wake vector call.

Recovery

Code	Description
F0	Recovery mode will be triggered due to invalid firmware volume detection.
F1	Recovery mode will be triggered by user decision.
F2	Recovery is started.
F3	Recovery firmware image is found.
F4	Recovery firmware image is loaded.
F5~F7	Reserved for future AML progress codes.

Error

Code	Description
50~55	Memory initialization error occurs.
56	Invalid CPU type or speed.
57	CPU mismatch.
58	CPU self test failed or possible CPU cache error.
59	CPU micro-code is not found or micro-code update is failed.
5A	Internal CPU error.
5B	Reset PPI is failed.
5C~5F	Reserved.
D0	CPU initialization error.
D1	IOH initialization error.

Code	Description
D2	PCH initialization error.
D3	Some of the Architectural Protocols are not available.
D4	PCI resource allocation error. Out of Resources.
D5	No Space for Legacy Option ROM initialization.
D6	No Console Output Devices are found.
D7	No Console Input Devices are found.
D8	It is an invalid password.
D9~DA	Can't load Boot Option.
DB	Flash update is failed.
DC	Reset protocol is failed.
DE~DF	Reserved.
E8	S3 resume is failed.
E9	S3 Resume PPI is not found.
EA	S3 Resume Boot Script is invalid.
EB	S3 OS Wake call is failed.
EC~EF	Reserved.
F8	Recovery PPI is invalid.
F9	Recovery capsule is not found.
FA	Invalid recovery capsule.
FB~FF	Reserved.

Regulatory Notices

United States of America, Federal Communications Commission Statement

Supplier's Declaration of Conformity 47 CFR § 2.1077 Compliance Information

Product Name: **Motherboard**
Trade Name: **GIGABYTE**
Model Number: **Z890 AERO G**

Responsible Party – U.S. Contact Information: **G.B.T. Inc.**
Address: 17358 Railroad street, City Of Industry, CA91748
Tel.: 1-626-854-9338
Internet contact information: <https://www.gigabyte.com>

FCC Compliance Statement:

This device complies with Part 15 of the FCC Rules, Subpart B, Unintentional Radiators. Operation is subject to the following two conditions: (1) This device may not cause harmful interference, and (2) this device must accept any interference received, including interference that may cause undesired operation.

The FCC with its action in ET Docket 96-8 has adopted a safety standard for human exposure to radio frequency (RF) electromagnetic energy emitted by FCC certified equipment. The Intel PRO/Wireless 5000 LAN products meet the Human Exposure limits found in OET Bulletin 65, 2001, and ANSI/IEEE C95.1, 1992. Proper operation of this radio according to the instructions found in this manual will result in exposure substantially below the FCC's recommended limits.

The following safety precautions should be observed:

- Do not touch or move antenna while the unit is transmitting or receiving.
- Do not hold any component containing the radio such that the antenna is very close or touching any exposed parts of the body, especially the face or eyes, while transmitting.
- Do not operate the radio or attempt to transmit data unless the antenna is connected; if not, the radio may be damaged.
- Use in specific environments:
 - The use of wireless devices in hazardous locations is limited by the constraints posed by the safety directors of such environments.
 - The use of wireless devices on airplanes is governed by the Federal Aviation Administration (FAA).
 - The use of wireless devices in hospitals is restricted to the limits set forth by each hospital.

Antenna use:

In order to comply with FCC RF exposure limits, low gain integrated antennas should be located at a minimum distance of 7.9 inches (20 cm) or more from the body of all persons.

Explosive Device Proximity Warning

Warning: Do not operate a portable transmitter (such as a wireless network device) near unshielded blasting caps or in an explosive environment unless the device has been modified to be qualified for such use.

Antenna Warning

The wireless adapter is not designed for use with high-gain antennas.

Use On Aircraft Caution

Caution: Regulations of the FCC and FAA prohibit airborne operation of radio-frequency wireless devices because their signals could interfere with critical aircraft instruments.

Other Wireless Devices

Safety Notices for Other Devices in the Wireless Network: Refer to the documentation supplied with wireless Ethernet adapters or other devices in the wireless network.

Canada, Canada-Industry Notice:

This device complies with Industry Canada license-exempt RSS standard(s). Operation is subject to the following two conditions:

- (1) this device may not cause interference, and
 - (2) this device must accept any interference, including interference that may cause undesired operation of the device.
- Cet appareil est conforme aux normes Canada d'industrie de RSS permis-exempt. L'utilisation est assujéti aux deux conditions suivantes: (1) le dispositif ne doit pas produire de brouillage préjudiciable, et (2) ce dispositif doit accepter tout brouillage reçu, y compris un brouillage susceptible de provoquer un fonctionnement indésirable.

Caution: When using IEEE 802.11a wireless LAN, this product is restricted to indoor use due to its operation in the 5.15-to 5.25-GHz frequency range. Industry Canada requires this product to be used indoors for the frequency range of 5.15 GHz to 5.25 GHz to reduce the potential for harmful interference to co-channel mobile satellite systems. High power radar is allocated as the primary user of the 5.25-to 5.35-GHz and 5.65 to 5.85-GHz bands. These radar stations can cause interference with and/or

damage to this device. The maximum allowed antenna gain for use with this device is 6dBi in order to comply with the E.I.R.P limit for the 5.25-to 5.35 and 5.725 to 5.85 GHz frequency range in point-to-point operation. To comply with RF exposure requirements all antennas should be located at a minimum distance of 20cm, or the minimum separation distance allowed by the module approval, from the body of all persons.

Attention: l'utilisation d'un réseau sans fil IEEE802.11a est restreinte à une utilisation en intérieur à cause du fonctionnement dans la bande de fréquence 5.15-5.25 GHz. Industry Canada requiert que ce produit soit utilisé à l'intérieur des bâtiments pour la bande de fréquence 5.15-5.25 GHz afin de réduire les possibilités d'interférences nuisibles aux canaux co-existants des systèmes de transmission satellites. Les radars de puissances ont fait l'objet d'une allocation primaire de fréquences dans les bandes 5.25-5.35 GHz et 5.65-5.85 GHz. Ces stations radar peuvent créer des interférences avec ce produit et/ou lui être nuisible. Le gain d'antenne maximum permise pour une utilisation avec ce produit est de 6 dBi afin d'être conforme aux limites de puissance isotropique rayonnée équivalente (P.I.R.E.) applicable dans les bandes 5.25-5.35 GHz et 5.725-5.85 GHz en fonctionnement point-à-point. Pour se conformer aux conditions d'exposition de RF toutes les antennes devraient être localisées à une distance minimum de 20 cm, ou la distance de séparation minimum permise par l'approbation du module, du corps de toutes les personnes.

Under Industry Canada regulations, this radio transmitter may only operate using an antenna of a type and maximum (or lesser) gain approved for the transmitter by Industry Canada. To reduce potential radio interference to other users, the antenna type and its gain should be chosen so that the equivalent isotropically radiated power (e.i.r.p.) is not more than that necessary for successful communication.

Conformément à la réglementation d'Industry Canada, le présent émetteur radio peut fonctionner avec une antenne d'un type et d'un gain maximal (ou inférieur) approuvé pour l'émetteur par Industry Canada. Dans le but de réduire les risques de brouillage radio électrique à l'intention des autres utilisateurs, il faut choisir le type d'antenne et son gain de sorte que la puissance isotrope rayonnée équivalente (p.i.r.e.) ne dépasse pas l'intensité nécessaire à l'établissement d'une communication satisfaisante.

European Union (EU) CE Declaration of Conformity

This device complies with the following directives: Electromagnetic Compatibility Directive 2014/30/EU, Low-voltage Directive 2014/35/EU, Radio Equipment Directive 2014/53/EU, ErP Directive 2009/125/EC, RoHS directive (recast) 2011/65/EU & the 2015/863 Statement.

This product has been tested and found to comply with all essential requirements of the Directives.

European Union (EU) RoHS (recast) Directive 2011/65/EU & the European Commission Delegated Directive (EU) 2015/863 Statement

GIGABYTE products have not intended to add and safe from hazardous substances (Cd, Pb, Hg, Cr+6, PBDE, PBB, DEHP, BBP, DBP and DIBP). The parts and components have been carefully selected to meet RoHS requirement. Moreover, we at GIGABYTE are continuing our efforts to develop products that do not use internationally banned toxic chemicals.

European Union (EU) Community Waste Electrical & Electronic Equipment (WEEE) Directive Statement

GIGABYTE will fulfill the national laws as interpreted from the 2012/19/EU WEEE (Waste Electrical and Electronic Equipment) (recast) directive. The WEEE Directive specifies the treatment, collection, recycling and disposal of electric and electronic devices and their components. Under the Directive, used equipment must be marked, collected separately, and disposed of properly.

WEEE Symbol Statement



The symbol shown below is on the product or on its packaging, which indicates that this product must not be disposed of with other waste. Instead, the device should be taken to the waste collection centers for activation of the treatment, collection, recycling and disposal procedure.

For more information about where you can drop off your waste equipment for recycling, please contact your local government office, your household waste disposal service or where you purchased the product for details of environmentally safe recycling.

Battery Information

European Union—Disposal and recycling information
GIGABYTE Recycling Program (available in some regions)



This symbol indicates that this product and/or battery should not be disposed of with household waste. You must use the public collection system to return, recycle, or treat them in compliance with the local regulations.

End of Life Directives-Recycling



The symbol shown below is on the product or on its packaging, which indicates that this product must not be disposed of with other waste. Instead, the device should be taken to the waste collection centers for activation of the treatment, collection, recycling and disposal procedure.

Déclaration de Conformité aux Directives de l'Union européenne (UE)

Cet appareil portant la marque CE est conforme aux directives de l'UE suivantes: directive Compatibilité Electromagnétique 2014/30/UE, directive Basse Tension 2014/35/UE, directive équipements radioélectriques 2014/53/UE, la directive RoHS II 2011/65/UE & la déclaration 2015/863. La conformité à ces directives est évaluée sur la base des normes européennes harmonisées applicables.

European Union (EU) CE-Konformitätserklärung

Dieses Produkte mit CE-Kennzeichnung erfüllen folgenden EU-Richtlinien: EMV-Richtlinie 2014/30/EU, Niederspannungsrichtlinie 2014/35/EU, Funkanlagen Richtlinie 2014/53/EU, RoHS-Richtlinie 2011/65/EU erfüllt und die 2015/863 Erklärung.

Die Konformität mit diesen Richtlinien wird unter Verwendung der entsprechenden Standards zur Europäischen Normierung beurteilt.

CE declaração de conformidade

Este produto com a marcação CE estão em conformidade com das seguintes Diretivas UE: Diretiva Baixa Tensão 2014/35/EU; Diretiva CEM 2014/30/EU; Diretiva RSP 2011/65/EU e a declaração 2015/863.

A conformidade com estas diretivas é verificada utilizando as normas europeias harmonizadas.

CE Declaración de conformidad

Este producto que llevan la marca CE cumplen con las siguientes Directivas de la Unión Europea: Directiva EMC 2014/30/EU, Directiva de bajo voltaje 2014/35/EU, Directiva de equipamientos de radio 2014/53/EU, Directiva RoHS 2011/65/EU y la Declaración 2015/863.

El cumplimiento de estas directivas se evalúa mediante las normas europeas armonizadas.

CE Dichiarazione di conformità

I prodotti con il marchio CE sono conformi con una o più delle seguenti Direttive UE, come applicabile: Direttiva EMC 2014/30/UE, Direttiva sulla bassa tensione 2014/35/UE, Direttiva di apparecchiature radio 2014/53/UE, Direttiva RoHS 2011/65/UE e Dichiarazione 2015/863.

La conformità con tali direttive viene valutata utilizzando gli Standard europei armonizzati applicabili.

Deklaracja zgodności UE Unii Europejskiej

Urządzenie jest zgodne z następującymi dyrektywami: Dyrektywa kompatybilności elektromagnetycznej 2014/30/UE, Dyrektywa niskonapięciowej 2014/35/UE, Dyrektywa urządzeń radiowych 2014/53/UE, Dyrektywa RoHS 2011/65/UE i dyrektywa 2015/863.

Niniejsze urządzenie zostało poddane testom i stwierdzono jego zgodność z wymaganiami dyrektywy.

ES Prohlášení o shodě

Toto zařízení splňuje požadavky Směrnice o Elektromagnetické kompatibilitě 2014/30/EU, Směrnice o Nízkém napětí 2014/35/EU, Směrnice o rádiových zařízeních 2014/53/EU, Směrnice RoHS 2011/65/EU a 2015/863.

Tento produkt byl testován a bylo shledáno, že splňuje všechny základní požadavky směrnice.

EK meglefelelősi nyilatkozata

A termék megfelelnek az alábbi irányelvek és szabványok követelményeinek, azok a kiállításidőpontjában érvényes, aktuális változatában: EMC irányelv 2014/30/EU, Kíszfeszültségű villamos berendezésekre vonatkozó irányelv 2014/35/EU, rádióberendezések irányelv 2014/53/EU, RoHS irányelv 2011/65/EU és 2015/863.

Δήλωση συμμόρφωσης ΕΕ

Είναι τα συμμόρφωση με τις διατάξεις των παρακάτω Οδηγιών της Ευρωπαϊκής Κοινότητας: Οδηγία 2014/30/ΕΕ σχετικά με την ηλεκτρομαγνητική συμβατότητα, Οδηγία χαμηλής τάσης 2014/35/ΕΕ, Οδηγία 2014/53/ΕΕ σε ραδιοεπιπλοισμούς, Οδηγία RoHS 2011/65/ΕΕ και 2015/863.

Η συμμόρφωση με αυτές τις οδηγίες αξιολογείται χρησιμοποιώντας τα ισχύοντα εναρμονισμένα ευρωπαϊκά πρότυπα.



D33006
RoHS

WARNING

- **INGESTION HAZARD:** This product contains a button cell or coin battery.
- **DEATH** or serious injury can occur if ingested.
- A swallowed button cell or coin battery can cause **Internal Chemical Burns** in as little as 2 hours
- **KEEP new and used batteries OUT OF REACH OF CHILDREN**
- **Seek immediate medical attention** if a battery is suspected to be swallowed or inserted into any part of the body.



- Battery type: CR2032, voltage rating: +3VDC.
- Non-rechargeable batteries are not to be recharged.
- Remove and immediately recycle or dispose of used batteries, batteries from equipment not used for an extended period of time according to local regulations and keep away from children. Do NOT dispose of batteries in household trash or incinerate.
- Even used batteries may cause severe injury or death.
- Do not force discharge, recharge, disassemble, heat above (manufacturer's specified temperature rating) or incinerate. Doing so may result in injury due to venting, leakage or explosion resulting in chemical burns.
- For treatment information, call a local poison control center.
- The product contains non-replaceable batteries.

European Community Directive R&TTE Directive Compliance Statement:

This equipment complies with all the requirements and other relevant provisions of Radio Equipment Directive 2014/53/EU.

The IEEE 802.11 wireless LAN 5.15 GHz~5.35 GHz and/or Wi-Fi 6E Low Power Indoor 5.945 GHz~6.425 GHz (or 5.925 GHz~6.425 GHz in UK) frequency bands are restricted for indoor use only in all countries listed in the matrix below.

		AT	BE	BG	CH	CY	CZ	DE
		DK	EE	EL	ES	FI	FR	HR
		HU	IE	IS	IT	LI	LT	LU
		LV	MT	NL	PL	PT	RO	SE
		SI	SK	TR				

UK The Radio Equipment Regulations 2017 Statement:

This equipment complies with all the requirements and other relevant provisions of Radio Equipment Regulations 2017.

The IEEE 802.11 wireless LAN 5.15 GHz~5.35 GHz and/or Wi-Fi 6E Low Power Indoor 5.925 GHz~6.425 GHz frequency bands are restricted for indoor use only.

	UK
---	----

NCC Wireless Statements / 無線設備警告聲明：

低功率電波輻射性電機管理辦法

- 取得審驗證明之低功率射頻器材，非經核准，公司、商號或使用者均不得擅自變更頻率、加大功率或變更原設計之特性及功能。低功率射頻器材之使用不得影響飛航安全及干擾合法通信；經發現有干擾現象時，應立即停用，並改善至無干擾時方得繼續使用。前述合法通信，指依電信管理法規定作業之無線電通信。低功率射頻器材須忍受合法通信或工業、科學及醫療用電波輻射性電機設備之干擾。
- 應避免影響附近雷達系統之操作。

Korea KCC NCC Wireless Statement:

5.25GHz - 5.35 GHz 대역을 사용하는 무선 장치는 실내에서만 사용하도록 제한됩니다.











Japan Wireless Statement:

5.15 GHz 帯 ~ 5.35 GHz 帯 & 6GHz LPI 帯：屋内のみの使用。

Wireless module approvals:

Wireless module manufacturer: Intel® Corporation

Wireless module model name: BE200NG W M

United States FCC: FCC ID: PD9BE200NG	Europe: 	Pakistan PTA: Approved by PTA TAC no.: 9.697/2023	 CCAH24Y10640T1
Canada ISED: IC: 1000M-BE200NG	India WPC: ETA-SD-20230807712	Serbia:  IT011 23	Ukraine:  UA.TR.028
Australia ACMA: 	Japan 総務省:  R 003-240052 T D230105003	Singapore IMDA: Complies with IMDA standards DA 108442	United Kingdom: 
Brazil:  06538-23-04423	5GHz (WS2,WS3) & 6GHz (LPI): 屋内限定 5GHz band (WS2,WS3) & 6GHz (LPI): indoor use only	South Korea NRRRA:  R-CINF-BE200NGW	
Belarus: 	Oman TRA: Applicant number: D080001 Approval no.: TRA/TA-R/16505/23	1.상호명: INTEL CORPORATION 2.가/제/제/발/행 (호명명): 韓商인텔(주) 무선기기 3.안전환경: 무선기기 무선기기 (5925-7123MHz) / BE200NGW 4.제조사(제조국): Intel Corporation / China, Taiwan	
China CMIIT: CMIIT ID: 2023AJ15347 (M)			



Contact Us

GIGA-BYTE TECHNOLOGY CO., LTD.

Address: No.6, Baoqiang Rd., Xindian Dist., New Taipei City 231

TEL: +886-2-8912-4000, FAX: +886-2-8912-4005

Tech. and Non-Tech. Support (Sales/Marketing) : <https://esupport.gigabyte.com>

WEB address (English): <https://www.gigabyte.com>

WEB address (Chinese): <https://www.gigabyte.com/tw>

- **GIGABYTE eSupport**

To submit a technical or non-technical (Sales/Marketing) question, please link to:
<https://esupport.gigabyte.com>

The screenshot shows the GIGABYTE eSupport landing page. At the top left is the GIGABYTE logo. The main heading is "Welcome to eSupport" in blue. Below it, a sub-heading reads: "Submit your product/sponsorship/marketing questions or inquiries, and our representative will respond in a timely fashion." The page is divided into three main sections:

- NEWS:** A box with the text: "Your submissions will be displayed in your personal page, log in to see the processing status."
- SIGN IN:** A login form with fields for "Account" and "Password". Below the fields are links for "Register" and "Forgot Password", and a blue "LOG IN" button. To the right, there is a "sign in with" section featuring social media icons for Facebook, Google, Twitter, and Microsoft.
- QUICK LINK:** A section with three icons: "Downloads" (cloud icon), "FAQ" (speech bubble icon), and "Warranty" (shield icon).