

X570S AERO G

User's Manual

Rev. 1101



For more product details, please visit GIGABYTE's website.

<https://www.gigabyte.com/Motherboard/X570S-AERO-G-rev-1x?m=ma#kf>

GIGABYTE will reduce paper use in order to fulfill the responsibilities of a global citizen. Also, to reduce the impacts on global warming, the packaging materials of this product are recyclable and reusable. GIGABYTE works with you to protect the environment.

Copyright

© 2023 GIGA-BYTE TECHNOLOGY CO., LTD. All rights reserved.

The trademarks mentioned in this manual are legally registered to their respective owners.

Disclaimer

Information in this manual is protected by copyright laws and is the property of GIGABYTE. Changes to the specifications and features in this manual may be made by GIGABYTE without prior notice. No part of this manual may be reproduced, copied, translated, transmitted, or published in any form or by any means without GIGABYTE's prior written permission.

- For detailed product information, carefully read the User's Manual.
- For quick set-up of the product, refer to the Quick Installation Guide on GIGABYTE's website.

https://download.gigabyte.com/FileList/Manual/mb_manual_installation-guide_103.pdf?m=sw

For product-related information, check on our website at: <https://www.gigabyte.com>

Identifying Your Motherboard Revision

The revision number on your motherboard looks like this: "REV: X.X." For example, "REV: 1.0" means the revision of the motherboard is 1.0. Check your motherboard revision before updating motherboard BIOS, drivers, or when looking for technical information.

Example:



Table of Contents

X570S AERO G Motherboard Layout.....	4
X570S AERO G Motherboard Block Diagram	5
Chapter 1 Hardware Installation	6
1-1 Installation Precautions.....	6
1-2 Product Specifications.....	7
1-3 Installing the CPU	11
1-4 Installing the Memory.....	11
1-5 Installing an Expansion Card	12
1-6 Setting up AMD CrossFire™ Configuration	12
1-7 Back Panel Connectors.....	13
1-8 Internal Connectors.....	16
Chapter 2 BIOS Setup	28
2-1 Startup Screen	28
2-2 The Main Menu	29
2-3 Smart Fan 6	30
2-4 Favorites (F11).....	32
2-5 Tweaker.....	33
2-6 Settings	36
2-7 System Info.....	41
2-8 Boot.....	42
2-9 Save & Exit.....	45
Chapter 3 Appendix	46
3-1 Configuring a RAID Set.....	46
3-2 Drivers Installation.....	48
Regulatory Notices.....	49
Contact Us	52

X570S AERO G Motherboard Layout

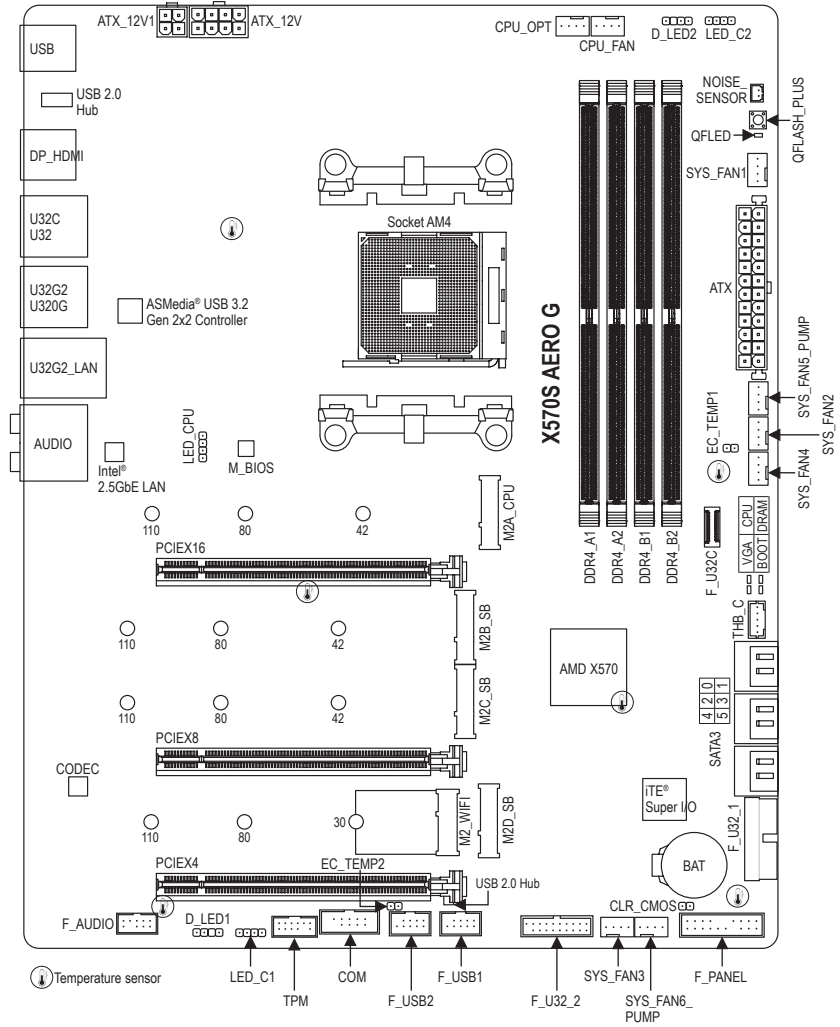

X570S AERO G Motherboard Block Diagram

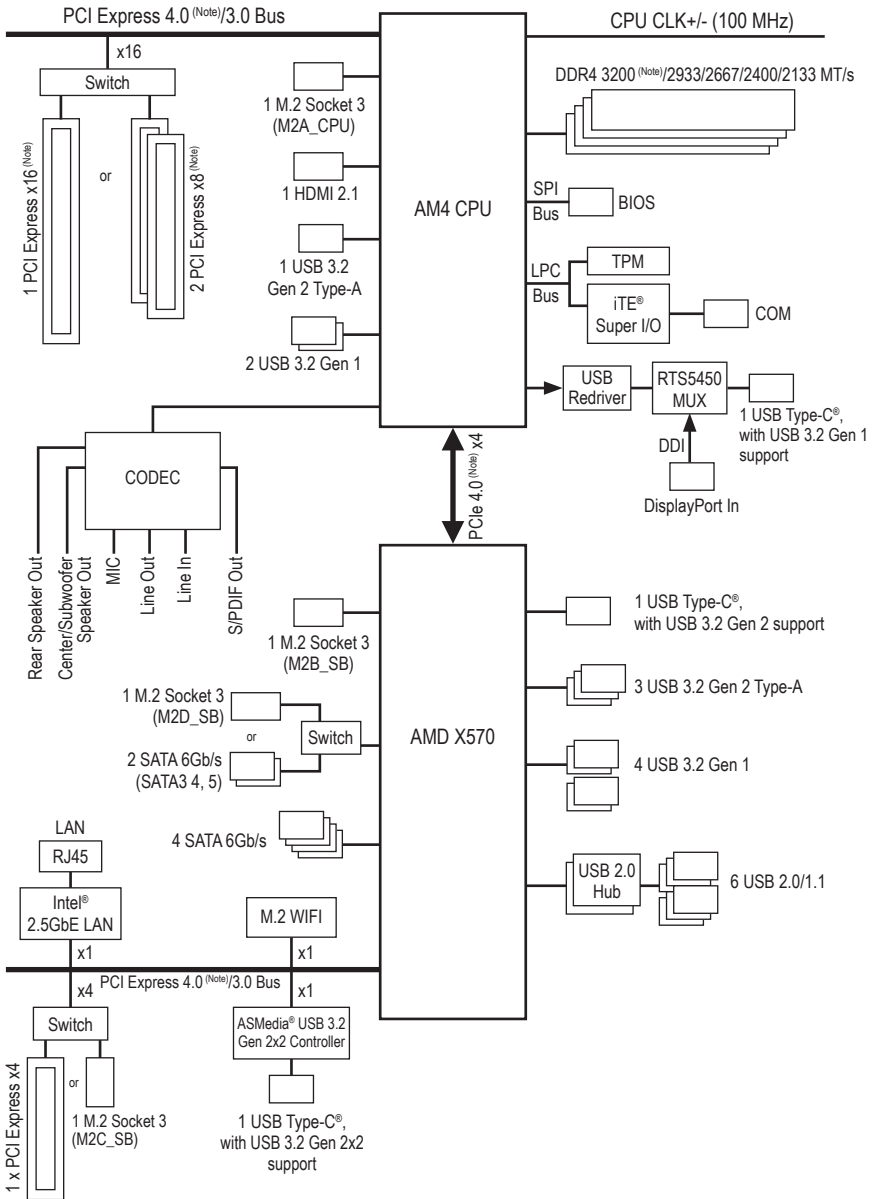

(Note) Actual support may vary by CPU.







Chapter 1 Hardware Installation

1-1 Installation Precautions

The motherboard contains numerous delicate electronic circuits and components which can become damaged as a result of electrostatic discharge (ESD). Prior to installation, carefully read the user's manual and follow these procedures:

- Prior to installation, make sure the chassis is suitable for the motherboard.
- Prior to installation, do not remove or break motherboard S/N (Serial Number) sticker or warranty sticker provided by your dealer. These stickers are required for warranty validation.
- Always remove the AC power by unplugging the power cord from the power outlet before installing or removing the motherboard or other hardware components.
- When connecting hardware components to the internal connectors on the motherboard, make sure they are connected tightly and securely.
- When handling the motherboard, avoid touching any metal leads or connectors.
- It is best to wear an electrostatic discharge (ESD) wrist strap when handling electronic components such as a motherboard, CPU or memory. If you do not have an ESD wrist strap, keep your hands dry and first touch a metal object to eliminate static electricity.
- Prior to installing the motherboard, please have it on top of an antistatic pad or within an electrostatic shielding container.
- Before connecting or unplugging the power supply cable from the motherboard, make sure the power supply has been turned off.
- Before turning on the power, make sure the power supply voltage has been set according to the local voltage standard.
- Before using the product, please verify that all cables and power connectors of your hardware components are connected.
- To prevent damage to the motherboard, do not allow screws to come in contact with the motherboard circuit or its components.
- Make sure there are no leftover screws or metal components placed on the motherboard or within the computer casing.
- Do not place the computer system on an uneven surface.
- Do not place the computer system in a high-temperature or wet environment.
- Turning on the computer power during the installation process can lead to damage to system components as well as physical harm to the user.
- If you are uncertain about any installation steps or have a problem related to the use of the product, please consult a certified computer technician.
- If you use an adapter, extension power cable, or power strip, ensure to consult with its installation and/or grounding instructions.

1-2 Product Specifications

	CPU	<ul style="list-style-type: none"> ◆ AMD Socket AM4, support for: AMD Ryzen™ 5000 Series Processors/ AMD Ryzen™ 5000 G-Series Processors/ AMD Ryzen™ 4000 G-Series Processors/ AMD Ryzen™ 3000 Series Processors/ AMD Ryzen™ 3000 G-Series Processors/ AMD Ryzen™ 2000 Series Processors/ AMD Ryzen™ 2000 G-Series Processors (Go to GIGABYTE's website for the latest CPU support list.)
	Chipset	<ul style="list-style-type: none"> ◆ AMD X570
	Memory	<ul style="list-style-type: none"> ◆ AMD Ryzen™ 5000 Series/5000 G-Series/4000 G-Series/3000 Series Processors: <ul style="list-style-type: none"> - Support for DDR4 3200/2933/2667/2400/2133 MT/s memory modules ◆ AMD Ryzen™ 3000 G-Series/2000 Series/2000 G-Series Processors: <ul style="list-style-type: none"> - Support for DDR4 2933/2667/2400/2133 MT/s memory modules ◆ 4 x DDR4 DIMM sockets supporting up to 128 GB (32 GB single DIMM capacity) of system memory ◆ Dual channel memory architecture ◆ Support for ECC Un-buffered DIMM 1Rx8/2Rx8 memory modules ◆ Support for non-ECC Un-buffered DIMM 1Rx8/2Rx8/1Rx16 memory modules ◆ Support for Extreme Memory Profile (XMP) memory modules (Go to GIGABYTE's website for the latest supported memory speeds and memory modules.)
	Onboard Graphics <small>(Note 1)</small>	<ul style="list-style-type: none"> ◆ Integrated Graphics Processor: <ul style="list-style-type: none"> - 1 x HDMI port, supporting a maximum resolution of 4096x2160@60 Hz <ul style="list-style-type: none"> * Support for HDMI 2.1 version, HDCP 2.3, and HDR. ◆ Maximum shared memory of 16 GB
	Audio	<ul style="list-style-type: none"> ◆ Realtek® ALC1220-VB Audio CODEC <ul style="list-style-type: none"> * The back panel line out jack supports DSD audio. ◆ Support for DTS:X® Ultra ◆ High Definition Audio ◆ 2/4/5.1/7.1-channel ◆ Support for S/PDIF Out
	LAN	<ul style="list-style-type: none"> ◆ Intel® 2.5GbE LAN chip (2.5 Gbps/1 Gbps/100 Mbps)
	Wireless Communication Module	<ul style="list-style-type: none"> ◆ Intel® Wi-Fi 6 AX200 (For PCB rev. 1.0) <ul style="list-style-type: none"> - WIFI a, b, g, n, ac, ax, supporting 2.4/5 GHz Dual-Band - BLUETOOTH 5.2 <ul style="list-style-type: none"> - Support for 11ax 160MHz wireless standard and up to 2.4 Gbps data rate ◆ AMD Wi-Fi 6E RZ608 (MT7921K) (For PCB rev. 1.1) <ul style="list-style-type: none"> - WIFI a, b, g, n, ac, ax, supporting 2.4/5/6 GHz carrier frequency bands - BLUETOOTH 5.2 <ul style="list-style-type: none"> - Support for 11ax 80MHz wireless standard and up to 1.2 Gbps data rate <p>(Actual data rate may vary depending on environment and equipment.)</p>

(Note 1) For AMD Ryzen™ 5000 G-Series/4000 G-Series/3000 G-Series/2000 G-Series Processors only.



Expansion Slots

- ◆ 1 x PCI Express x16 slot (PCIEX16), integrated in the CPU:
 - **AMD Ryzen™ 5000 Series/3000 Series Processors**
support PCIe 4.0 x16 mode
 - **AMD Ryzen™ 5000 G-Series/4000 G-Series/2000 Series Processors**
support PCIe 3.0 x16 mode
 - **AMD Ryzen™ 3000 G-Series/2000 G-Series Processors**
support PCIe 3.0 x8 mode
- ◆ 1 x PCI Express x16 slot (PCIEX8), integrated in the CPU:
 - **AMD Ryzen™ 5000 Series/3000 Series Processors**
support PCIe 4.0 x8 mode
 - **AMD Ryzen™ 5000 G-Series/4000 G-Series/2000 Series Processors**
support PCIe 3.0 x8 mode
 - AMD Ryzen™ 3000 G-Series/2000 G-Series Processors do not support this slot
 - * For optimum performance, if only one PCI Express graphics card is to be installed, be sure to install it in the PCIEX16 slot.
 - * The PCIEX8 slot shares bandwidth with the PCIEX16 slot. When the PCIEX8 slot is populated, the PCIEX16 slot operates at up to x8 mode.
- ◆ 1 x PCI Express x16 slot (PCIEX4), integrated in the Chipset:
 - Supporting PCIe 4.0 ^(Note 2)/3.0 x4 mode
 - * The PCIEX4 slot shares bandwidth with the M2C_SB connector. The PCIEX4 slot becomes unavailable when a device is installed in the M2C_SB connector.



Multi-Graphics Technology ^(Note 3)

- ◆ Support for AMD Quad-GPU CrossFire™ and 2-Way AMD CrossFire™ technologies



Storage Interface

- ◆ 1 x M.2 connector (M2A_CPU), integrated in the CPU, supporting Socket 3, M key, type 2242/2280/22110 SSDs:
 - **AMD Ryzen™ 5000-Series/3000 Series Processors**
support SATA and PCIe 4.0 x4/x2 SSDs
 - **AMD Ryzen™ 5000 G-Series/4000 G-Series/3000 G-Series/2000 Series/2000 G-Series Processors**
support SATA and PCIe 3.0 x4/x2 SSDs
- ◆ 1 x M.2 connector (M2B_SB), integrated in the Chipset, supporting Socket 3, M key, type 2242/2280/22110 SSDs:
 - Supporting PCIe 4.0 ^(Note 2)/3.0 x4/x2 SSDs
- ◆ 1 x M.2 connector (M2C_SB), integrated in the Chipset, supporting Socket 3, M key, type 2242/2280/22110 SSDs:
 - Supporting SATA and PCIe 4.0 ^(Note 2)/3.0 x4/x2 SSDs
- ◆ 1 x M.2 connector (M2D_SB), integrated in the Chipset, supporting Socket 3, M key, type 2280/22110 SSDs:
 - Supporting SATA and PCIe 4.0 ^(Note 2)/3.0 x4/x2 SSDs
- ◆ 6 x SATA 6Gb/s connectors, integrated in the Chipset:
 - Support for RAID 0, RAID 1, and RAID 10
 - * Refer to "1-8 Internal Connectors," for the installation notices for the M.2 and SATA connectors.

(Note 2) For AMD Ryzen™ 5000 Series/3000 Series Processors only.

(Note 3) For AMD Ryzen™ 5000 Series/5000 G-Series/4000 G-Series/3000 Series/2000 Series Processors only.



USB

- ◆ CPU:
 - 1 x USB Type-C® port on the back panel, with USB 3.2 Gen 1 support
 - * Support for drawing tablets and 20V@3A of power delivery.
 - 1 x USB 3.2 Gen 2 Type-A port (red) on the back panel
 - 2 x USB 3.2 Gen 1 ports on the back panel
- ◆ Chipset+ASMedia® USB 3.2 Gen 2x2 Controller:
 - 1 x USB Type-C® port on the back panel, with USB 3.2 Gen 2x2 support
- ◆ Chipset:
 - 1 x USB Type-C® port with USB 3.2 Gen 2 support, available through the internal USB header
 - 3 x USB 3.2 Gen 2 Type-A ports (red) on the back panel
 - 4 x USB 3.2 Gen 1 ports available through the internal USB headers
- ◆ Chipset+2 USB 2.0 Hubs:
 - 6 x USB 2.0/1.1 ports (2 ports on the back panel, 4 ports available through the internal USB headers)











Internal Connectors

- ◆ 1 x 24-pin ATX main power connector
- ◆ 1 x 8-pin ATX 12V power connector
- ◆ 1 x 4-pin ATX 12V power connector
- ◆ 1 x CPU fan header
- ◆ 1 x CPU fan/water cooling pump header
- ◆ 4 x system fan headers
- ◆ 2 x system fan/water cooling pump headers
- ◆ 2 x addressable LED strip headers
- ◆ 2 x RGB LED strip headers
- ◆ 1 x CPU cooler LED strip/RGB LED strip header
- ◆ 4 x M.2 Socket 3 connectors
- ◆ 6 x SATA 6Gb/s connectors
- ◆ 1 x front panel header
- ◆ 1 x front panel audio header
- ◆ 1 x USB Type-C® header, with USB 3.2 Gen 2 support
- ◆ 2 x USB 3.2 Gen 1 headers
- ◆ 2 x USB 2.0/1.1 headers
- ◆ 1 x noise detection header
- ◆ 1 x Trusted Platform Module (TPM) header (2x6 pin, for the GC-TPM2.0_S module only)
- ◆ 1 x Thunderbolt™ add-in card connector
- ◆ 1 x serial port header
- ◆ 1 x Clear CMOS jumper
- ◆ 2 x temperature sensor headers
- ◆ 1 x Q-Flash Plus button



Back Panel Connectors

- ◆ 2 x USB 2.0/1.1 ports
- ◆ 2 x SMA antenna connectors (2T2R)
- ◆ 1 x HDMI port
- ◆ 1 x DisplayPort In port
- ◆ 1 x USB Type-C® port, with USB 3.2 Gen 2x2 support
- ◆ 1 x USB Type-C® port, with USB 3.2 Gen 1 support

 Back Panel Connectors	<ul style="list-style-type: none"> ◆ 4 x USB 3.2 Gen 2 Type-A ports (red) ◆ 2 x USB 3.2 Gen 1 ports ◆ 1 x RJ-45 port ◆ 1 x optical S/PDIF Out connector ◆ 5 x audio jacks
 I/O Controller	<ul style="list-style-type: none"> ◆ iTE® I/O Controller Chip
 Hardware Monitor	<ul style="list-style-type: none"> ◆ Voltage detection ◆ Temperature detection ◆ Fan speed detection ◆ Water cooling flow rate detection ◆ Fan fail warning ◆ Fan speed control <ul style="list-style-type: none"> * Whether the fan (pump) speed control function is supported will depend on the fan (pump) you install. ◆ Noise detection
 BIOS	<ul style="list-style-type: none"> ◆ 1 x 256 Mbit flash ◆ Use of licensed AMI UEFI BIOS ◆ PnP 1.0a, DMI 2.7, WfM 2.0, SM BIOS 2.7, ACPI 5.0
 Unique Features	<ul style="list-style-type: none"> ◆ Support for APP Center <ul style="list-style-type: none"> * Available applications in APP Center may vary by motherboard model. Supported functions of each application may also vary depending on motherboard specifications. - @BIOS - EasyTune - ON/OFF Charge - RGB Fusion - Smart Backup - System Information Viewer ◆ Support for Q-Flash Plus ◆ Support for Q-Flash ◆ Support for Xpress Install
 Bundled Software	<ul style="list-style-type: none"> ◆ Norton® Internet Security (OEM version) ◆ LAN bandwidth management software
 Operating System	<ul style="list-style-type: none"> ◆ Support for Windows 11 64-bit ◆ Support for Windows 10 64-bit
 Form Factor	<ul style="list-style-type: none"> ◆ ATX Form Factor; 30.5cm x 24.4cm

* GIGABYTE reserves the right to make any changes to the product specifications and product-related information without prior notice.

☞ Please visit GIGABYTE's website for support lists of CPU, memory modules, SSDs, and M.2 devices.
<https://www.gigabyte.com/Motherboard/X570S-AERO-G-rev-1x?m=d#support-dl>

☞ Please visit the **SERVICE/SUPPORTUtility** page on GIGABYTE's website to download the latest version of apps.
<https://www.gigabyte.com/Support/Utility/Motherboard?m=ut>

1-3 Installing the CPU



Read the following guidelines before you begin to install the CPU:

- Make sure that the motherboard supports the CPU.
(Go to GIGABYTE's website for the latest CPU support list.)
- Always turn off the computer and unplug the power cord from the power outlet before installing the CPU to prevent hardware damage.
- Locate the pin one of the CPU. The CPU cannot be inserted if oriented incorrectly.
- Apply an even and thin layer of thermal grease on the surface of the CPU.
- Do not turn on the computer if the CPU cooler is not installed, otherwise overheating and damage of the CPU may occur.
- Set the CPU host frequency in accordance with the CPU specifications. It is not recommended that the system bus frequency be set beyond hardware specifications since it does not meet the standard requirements for the peripherals. If you wish to set the frequency beyond the standard specifications, please do so according to your hardware specifications including the CPU, graphics card, memory, hard drive, etc.

Installing the CPU

Completely lift up the CPU socket locking lever. Locate the pin one (denoted by a small triangle) of the CPU socket and the CPU. Once the CPU is positioned into its socket, place one finger down on the middle of the CPU, lowering the locking lever and latching it into the fully locked position.

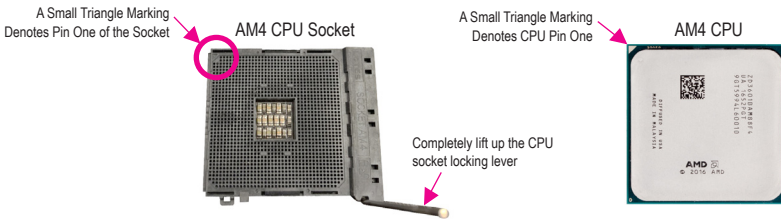

Do not force the CPU into the CPU socket before the CPU socket locking lever is lifted up, or damage to the CPU and CPU socket may occur.

1-4 Installing the Memory



Read the following guidelines before you begin to install the memory:

- Make sure that the motherboard supports the memory. It is recommended that memory of the same capacity, brand, speed, and chips be used.
(Go to GIGABYTE's website for the latest supported memory speeds and memory modules.)
- Always turn off the computer and unplug the power cord from the power outlet before installing the memory to prevent hardware damage.
- Memory modules have a foolproof design. A memory module can be installed in only one direction. If you are unable to insert the memory, switch the direction.
- When installing a single memory module, we recommend that you install it in the DDR4_A2 socket.

Dual Channel Memory Configuration

This motherboard provides four memory sockets and supports Dual Channel Technology. After the memory is installed, the BIOS will automatically detect the specifications and capacity of the memory. Enabling Dual Channel memory mode will double the original memory bandwidth.

☞ Please visit GIGABYTE's website for details on hardware installation.

<http://www.gigabyte.com/WebPage/210/quick-guide.html?m=sw>

The four memory sockets are divided into two channels and each channel has two memory sockets as following:

- ▶▶ Channel A: DDR4_A1, DDR4_A2
- ▶▶ Channel B: DDR4_B1, DDR4_B2

▶▶ Recommended Dual Channel Memory Configuration:

	DDR4_A1	DDR4_A2	DDR4_B1	DDR4_B2
2 Modules	--	DS/SS	--	DS/SS
4 Modules	DS/SS	DS/SS	DS/SS	DS/SS

(SS=Single-Sided, DS=Double-Sided, "--=No Memory)

Due to CPU limitations, read the following guidelines before installing the memory in Dual Channel mode.

1. Dual Channel mode cannot be enabled if only one memory module is installed.
2. When enabling Dual Channel mode with two or four memory modules, it is recommended that memory of the same capacity, brand, speed, and chips be used. For optimum performance, when enabling Dual Channel mode with two memory modules, we recommend that you install them in the DDR4_A2 and DDR4_B2 sockets.

1-5 Installing an Expansion Card



Read the following guidelines before you begin to install an expansion card:

- Make sure the motherboard supports the expansion card. Carefully read the manual that came with your expansion card.
- Always turn off the computer and unplug the power cord from the power outlet before installing an expansion card to prevent hardware damage.

1-6 Setting up AMD CrossFire™ Configuration ^(Note 1)

A. System Requirements

- Windows 10 64-bit operating system
- A CrossFire-supported motherboard with two or more PCI Express x16 slots and correct driver
- CrossFire-ready graphics cards of identical brand and chip and correct driver
- CrossFire ^(Note 2) bridge connectors
- A power supply with sufficient power is recommended (Refer to the manual of your graphics cards for the power requirement)

B. Connecting the Graphics Cards

Step 1:

Observe the steps in "1-5 Installing an Expansion Card" and install the graphics cards on the PCIEX16 and PCIEX8 slots.

Step 2:

Insert the CrossFire ^(Note 2) bridge connectors in the CrossFire gold edge connectors on top of the cards.

Step 3:

Plug the display cable into the graphics card on the PCIEX16 slot.

C. Configuring the Graphics Card Driver

After installing the graphics card driver in the operating system, go to the **AMD RADEON SETTINGS** screen. Browse to **Gaming|Global Settings** and ensure **AMD CrossFire** is set to **On**.

(Note 1) For AMD Ryzen™ 5000 Series/5000 G-Series/4000 G-Series/3000 Series/2000 Series Processors only.

(Note 2) The bridge connector(s) may be needed or not depending on your graphics cards.



Procedure and driver screen for enabling CrossFire technology may differ by graphics cards and driver version. Refer to the manual that came with your graphics cards for more information about enabling CrossFire technology.

1-7 Back Panel Connectors

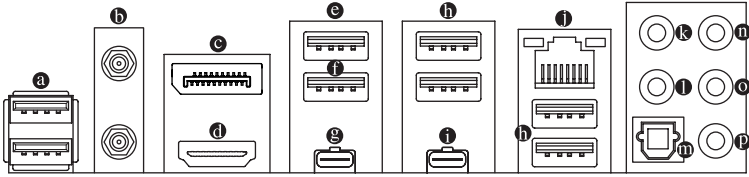

a USB 2.0/1.1 Port

The USB port supports the USB 2.0/1.1 specification. Use this port for USB devices.

b SMA Antenna Connectors (2T2R)

Use this connector to connect an antenna.



Tighten the antennas to the antenna connectors and then aim the antennas correctly for better signal reception.

c DisplayPort In Port

The DisplayPort In port offers video outputs to the motherboard. Refer to the **g** USB Type-C® (USB 3.2 Gen 1) port for more information.

d HDMI Port ^(Note 1)

HDMI™ HIGH-DEFINITION MULTIMEDIA INTERFACE The HDMI port is HDCP 2.3 compliant and supports Dolby TrueHD and DTS HD Master Audio formats. It also supports up to 192KHz/24bit 7.1-channel LPCM audio output. You can use this port to connect your HDMI-supported monitor. The maximum supported resolution is 4096x2160@60 Hz, but the actual resolutions supported are dependent on the monitor being used.



After installing the HDMI device, make sure to set the default sound playback device to HDMI. (The item name may differ depending on your operating system.)

e USB 3.2 Gen 1 Port

The USB 3.2 Gen 1 port supports the USB 3.2 Gen 1 specification and is compatible to the USB 2.0 specification. Use this port for USB devices.

f USB 3.2 Gen 1 Port (Q-Flash Plus Port)

The USB 3.2 Gen 1 port supports the USB 3.2 Gen 1 specification and is compatible to the USB 2.0 specification. Before using Q-Flash Plus ^(Note 2), make sure to insert the USB flash drive into this port first.

g USB Type-C® Port

This port supports GIGABYTE VisionLINK technology and has display and data transmission capabilities with 20V@3A of power delivery. You can connect a drawing tablet to this port. The reversible USB port supports the USB 3.2 Gen 1 specification and is compatible to the USB 2.0 specification. You can use this port for USB devices, too.

(Note 1) For AMD Ryzen™ 5000 G-Series/4000 G-Series/3000 G-Series/2000 G-Series Processors only.

(Note 2) To enable the Q-Flash Plus function please visit the "Unique Features" webpage of GIGABYTE's website.

Follow the steps below to install the USB Type-C® or DisplayPort devices:



Step 1:
Connect your DisplayPort cable or Mini-DisplayPort cable (purchased separately) from the graphics card to the DisplayPort In port on the back panel.



Step 2:
Then connect the USB Type-C® or DisplayPort devices to USB Type-C® port to complete.

① USB 3.2 Gen 2 Type-A Port (Red)

The USB 3.2 Gen 2 port supports the USB 3.2 Gen 2 specification and is compatible to the USB 3.2 Gen 1 and USB 2.0 specification. Use this port for USB devices.

① USB Type-C® Port

The reversible USB port supports the USB 3.2 Gen 2x2 specification and is compatible to the USB 3.2 Gen 2, USB 3.2 Gen 1, and USB 2.0 specifications. Use this port for USB devices.

① RJ-45 LAN Port

The Gigabit Ethernet LAN port provides Internet connection at up to 2.5 Gbps data rate. The following describes the states of the LAN port LEDs.

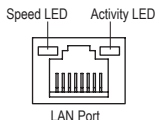

Speed LED:

State	Description
Green	2.5 Gbps data rate
Orange	1 Gbps data rate
Off	100 Mbps data rate

Activity LED:

State	Description
Blinking	Data transmission or receiving is occurring
On	No data transmission or receiving is occurring

① Center/Subwoofer Speaker Out (Orange)

Use this audio jack to connect center/subwoofer speakers.

① Rear Speaker Out (Black)

Use this audio jack to connect rear speakers.

① Optical S/PDIF Out Connector

This connector provides digital audio out to an external audio system that supports digital optical audio. Before using this feature, ensure that your audio system provides an optical digital audio in connector.



- When removing the cable connected to a back panel connector, first remove the cable from your device and then remove it from the motherboard.
- When removing the cable, pull it straight out from the connector. Do not rock it side to side to prevent an electrical short inside the cable connector.

⑪ **Line In/Side Speaker Out (Blue)**

The line in jack. Use this audio jack for line in devices such as an optical drive, walkman, etc.

⑫ **Line Out/Front Speaker Out (Green)**

The line out jack. This jack supports audio amplifying function. For better sound quality, it is recommended that you connect your headphone/speaker to this jack (actual effects may vary by the device being used).

⑬ **Mic In/Side Speaker Out (Pink)**

The Mic in jack.

Audio Jack Configurations:

Jack	Headphone/ 2-channel	4-channel	5.1-channel	7.1-channel
⑬ Center/Subwoofer Speaker Out			✓	✓
⑫ Rear Speaker Out		✓	✓	✓
⑪ Line In/Side Speaker Out				✓
⑫ Line Out/Front Speaker Out	✓	✓	✓	✓
⑬ Mic In				✓



- If you want to install a Side Speaker, you need to retask either the Line in or Mic in jack to be Side Speaker out through the audio driver.
- To enable or configure the audio amplifying function for the Line out jack, please access the Realtek Audio Console application.

☞ Please visit GIGABYTE's website for details on configuring the audio software.

<https://www.gigabyte.com/WebPage/698/realtek1220-audio.html>

1-8 Internal Connectors

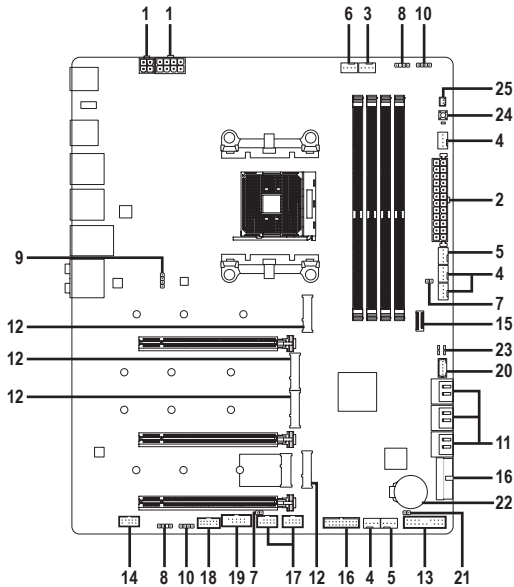

1) ATX_12V1/ATX_12V	14) F_AUDIO
2) ATX	15) F_U32C
3) CPU_FAN	16) F_U32_1/F_U32_2
4) SYS_FAN1/2/3/4	17) F_USB1/F_USB2
5) SYS_FAN5_PUMP/SYS_FAN6_PUMP	18) TPM
6) CPU_OPT	19) COM
7) EC_TEMP1/EC_TEMP2	20) THB_C
8) D_LED1/D_LED2	21) CLR_CMOS
9) LED_CPU	22) BAT
10) LED_C1/LED_C2	23) CPU/DRAM/VGA/BOOT
11) SATA3 0/1/2/3/4/5	24) QFLASH_PLUS
12) M2A_CPU/M2B_SB/M2C_SB/M2D_SB	25) NOISE_SENSOR
13) F_PANEL	



Read the following guidelines before connecting external devices:

- First make sure your devices are compliant with the connectors you wish to connect.
- Before installing the devices, be sure to turn off the devices and your computer. Unplug the power cord from the power outlet to prevent damage to the devices.
- After installing the device and before turning on the computer, make sure the device cable has been securely attached to the connector on the motherboard.

1/2) ATX_12V1/ATX_12V/ATX (2x2, 2x4, 12V Power Connectors and 2x12 Main Power Connector)

With the use of the power connector, the power supply can supply enough stable power to all the components on the motherboard. Before connecting the power connector, first make sure the power supply is turned off and all devices are properly installed. The power connector possesses a foolproof design. Connect the power supply cable to the power connector in the correct orientation.

The 12V power connector mainly supplies power to the CPU. If the 12V power connector is not connected, the computer will not start.



To meet expansion requirements, it is recommended that a power supply that can withstand high power consumption be used (500W or greater). If a power supply is used that does not provide the required power, the result can lead to an unstable or unbootable system.

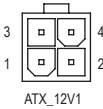

ATX_12V1:

Pin No.	Definition
1	GND
2	GND
3	+12V
4	+12V

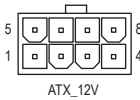

ATX_12V:

Pin No.	Definition	Pin No.	Definition
1	GND (Only for 2x4-pin 12V)	5	+12V (Only for 2x4-pin 12V)
2	GND (Only for 2x4-pin 12V)	6	+12V (Only for 2x4-pin 12V)
3	GND	7	+12V
4	GND	8	+12V

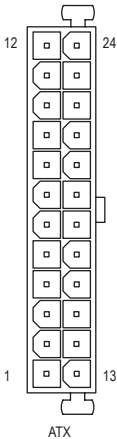

ATX:

Pin No.	Definition	Pin No.	Definition
1	3.3V	13	3.3V
2	3.3V	14	-12V
3	GND	15	GND
4	+5V	16	PS_ON (soft On/Off)
5	GND	17	GND
6	+5V	18	GND
7	GND	19	GND
8	Power Good	20	NC
9	5VSB (stand by +5V)	21	+5V
10	+12V	22	+5V
11	+12V (Only for 2x12-pin ATX)	23	+5V (Only for 2x12-pin ATX)
12	3.3V (Only for 2x12-pin ATX)	24	GND (Only for 2x12-pin ATX)

3/4) CPU_FAN/SYS_FAN1/2/3/4 (Fan Headers)

All fan headers on this motherboard are 4-pin. Most fan headers possess a foolproof insertion design. When connecting a fan cable, be sure to connect it in the correct orientation (the black connector wire is the ground wire). The speed control function requires the use of a fan with fan speed control design. For optimum heat dissipation, it is recommended that a system fan be installed inside the chassis.

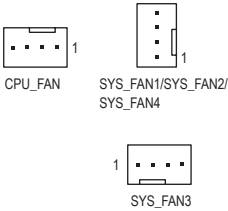

Pin No.	Definition
1	GND
2	Voltage Speed Control
3	Sense
4	PWM Speed Control

5) SYS_FAN5_PUMP/SYS_FAN6_PUMP (System Fan/Water Cooling Pump Headers)

The fan/pump headers are 4-pin. Most fan headers possess a foolproof insertion design. When connecting a fan cable, be sure to connect it in the correct orientation (the black connector wire is the ground wire). The speed control function requires the use of a fan with fan speed control design. For optimum heat dissipation, it is recommended that a system fan be installed inside the chassis. The header also provides speed control for a water cooling pump, refer to Chapter 2, "BIOS Setup," "Smart Fan 6," for more information.

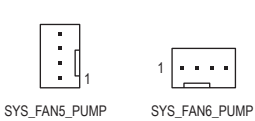

Pin No.	Definition
1	GND
2	Voltage Speed Control
3	Sense
4	PWM Speed Control

6) CPU_OPT (CPU Fan/Water Cooling Pump Header)

The fan/pump header is 4-pin and possesses a foolproof insertion design. Most fan headers possess a foolproof insertion design. When connecting a fan cable, be sure to connect it in the correct orientation (the black connector wire is the ground wire). The speed control function requires the use of a fan with fan speed control design.



Pin No.	Definition
1	GND
2	Voltage Speed Control
3	Sense
4	PWM Speed Control

Connector	CPU_FAN	SYS_FAN1~4	SYS_FAN5/6_PUMP	CPU_OPT
Maximum Current	2A	2A	2A	2A
Maximum Power	24W	24W	24W	24W



- Be sure to connect fan cables to the fan headers to prevent your CPU and system from overheating. Overheating may result in damage to the CPU or the system may hang.
- These fan headers are not configuration jumper blocks. Do not place a jumper cap on the headers.

7) EC_TEMP1/EC_TEMP2 (Temperature Sensor Headers)

Connect the thermistor cables to the headers for temperature detection.

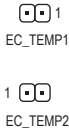

Pin No.	Definition
1	SENSOR IN
2	GND

8) D_LED1/D_LED2 (Addressable LED Strip Headers)

The headers can be used to connect a standard 5050 addressable LED strip, with maximum power rating of 5A (5V) and maximum number of 1000 LEDs.

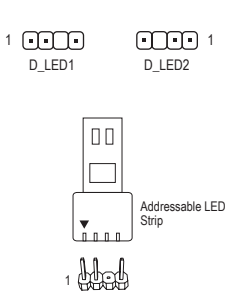

Pin No.	Definition
1	V (5V)
2	Data
3	No Pin
4	GND

Connect your addressable LED strip to the header. The power pin (marked with a triangle on the plug) of the LED strip must be connected to Pin 1 of the addressable LED strip header. Incorrect connection may lead to the damage of the LED strip.

9) LED_CPU (CPU Cooler LED Strip/RGB LED Strip Header)

The header can be used to connect a CPU cooler LED strip or a standard 5050 RGB LED strip (12V/G/R/B), with maximum power rating of 2A (12V) and maximum length of 2m.

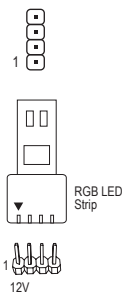

Pin No.	Definition
1	12V
2	G
3	R
4	B

Connect the CPU cooler LED strip/RGB LED strip to the header. The power pin (marked with a triangle on the plug) of the LED strip must be connected to Pin 1 (12V) of this header. Incorrect connection may lead to the damage of the LED strip.



For how to turn on/off the lights of the LED strip please visit the "Unique Features" webpage of GIGABYTE's website.



Before installing the devices, be sure to turn off the devices and your computer. Unplug the power cord from the power outlet to prevent damage to the devices.

10) LED_C1/LED_C2 (RGB LED Strip Headers)

The headers can be used to connect a standard 5050 RGB LED strip (12V/G/R/B), with maximum power rating of 2A (12V) and maximum length of 2m.

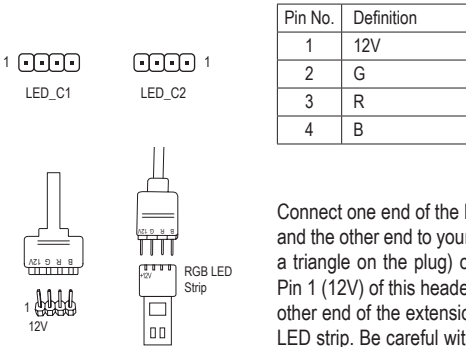

Connect one end of the RGB LED strip extension cable to the header and the other end to your RGB LED strip. The black wire (marked with a triangle on the plug) of the extension cable must be connected to Pin 1 (12V) of this header. The 12V pin (marked with an arrow) on the other end of the extension cable must be lined up with the 12V of the LED strip. Be careful with the connection orientation of the LED strip; incorrect connection may lead to the damage of the LED strip.



For how to turn on/off the lights of the LED strip please visit the "Unique Features" webpage of GIGABYTE's website.



Before installing the devices, be sure to turn off the devices and your computer. Unplug the power cord from the power outlet to prevent damage to the devices.

11) SATA3 0/1/2/3/4/5 (SATA 6Gb/s Connectors)

The SATA connectors conform to SATA 6Gb/s standard and are compatible with SATA 3Gb/s and SATA 1.5Gb/s standard. Each SATA connector supports a single SATA device. The SATA connectors support RAID 0, RAID 1, and RAID 10. Refer to Chapter 3, "Configuring a RAID Set," for instructions on configuring a RAID array.

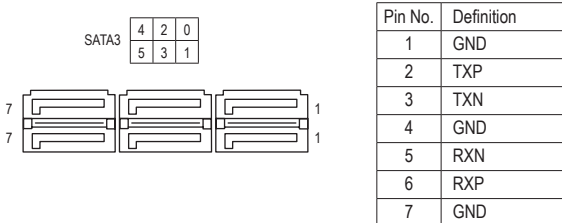

To enable hot-plugging for the SATA ports, refer to Chapter 2, "BIOS Setup," "Settings\IO Ports\ SATA Configuration," for more information.

12) M2A_CPU/M2B_SB/M2C_SB/M2D_SB (M.2 Socket 3 Connectors)

The M.2 connectors support M.2 SATA SSDs or M.2 PCIe SSDs and support RAID configuration. Please note that an M.2 PCIe SSD cannot be used to create a RAID set either with an M.2 SATA SSD or a SATA hard drive. Refer to Chapter 3, "Configuring a RAID Set," for instructions on configuring a RAID array.

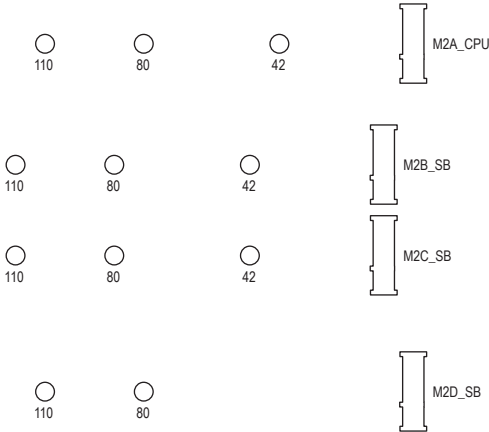

Follow the steps below to correctly install an M.2 SSD in the M.2 connector.

Step 1:

Locate the M.2 connector where you will install the M.2 SSD, use a screwdriver to unfasten the screw on the heatsink and then remove the heatsink. Remove the protective film from the thermal pad on the M.2 connector (Only the M2A_CPU connector has the heatsink).

Step 2:

Locate the proper mounting hole based on the length of your M.2 SSD drive. If needed, move the standoff to the desired mounting hole. Insert the M.2 SSD into the M.2 connector at an angle.

Step 3:

Press the M.2 SSD down and then use the included screw to secure it in the connector. Replace the heatsink and secure it to the original hole. Remove the protective film from the bottom of the heatsink before replacing the heatsink.

Installation Notices for the PCIeX4, M.2, and SATA Connectors:

The availability of the SATA connectors may be affected by the type of device installed in the M.2 sockets. The M2C_SB connector shares bandwidth with the PCIeX4 slot. The M2D_SB connector shares bandwidth with the SATA3 4, 5 connectors. Refer to the following tables for details.

• M2A_CPU:

Type of M.2 SSD \ Connector	SATA3 0	SATA3 1	SATA3 2	SATA3 3	SATA3 4	SATA3 5
M.2 SATA SSD	✓	✓	✓	✓	✓	✓
M.2 PCIe SSD	✓	✓	✓	✓	✓	✓
No M.2 SSD Installed	✓	✓	✓	✓	✓	✓

✓ : Available, ✗ : Not available

• M2B_SB:

Type of M.2 SSD \ Connector	SATA3 0	SATA3 1	SATA3 2	SATA3 3	SATA3 4	SATA3 5
M.2 PCIe SSD *	✓	✓	✓	✓	✓	✓
No M.2 SSD Installed	✓	✓	✓	✓	✓	✓

✓ : Available, ✗ : Not available

* The M2B_SB connector supports only PCIe SSDs.

• M2C_SB:

Type of M.2 SSD \ Connector	SATA3 0	SATA3 1	SATA3 2	SATA3 3	SATA3 4	SATA3 5	PCIEX4
M.2 SATA SSD	✓	✓	✓	✓	✓	✓	✓
M.2 PCIe SSD	✓	✓	✓	✓	✓	✓	✗ ^(Note)
No M.2 SSD Installed	✓	✓	✓	✓	✓	✓	✓

✓ : Available, ✗ : Not available

• M2D_SB:

Type of M.2 SSD \ Connector	SATA3 0	SATA3 1	SATA3 2	SATA3 3	SATA3 4	SATA3 5
M.2 SATA SSD	✓	✓	✓	✓	✓	✓
M.2 PCIe SSD	✓	✓	✓	✓	✗	✗
No M.2 SSD Installed	✓	✓	✓	✓	✓	✓

✓ : Available, ✗ : Not available

(Note) The PCIeX4 slot shares bandwidth with the M2C_SB connector. The PCIeX4 slot becomes unavailable when a device is installed in the M2C_SB connector.

13) F_PANEL (Front Panel Header)

Connect the power switch, reset switch, speaker, chassis intrusion switch/sensor and system status indicator on the chassis to this header according to the pin assignments below. Note the positive and negative pins before connecting the cables.

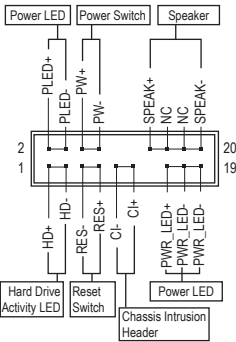

- **PLED/PWR_LED (Power LED):**

System Status	LED
S0	On
S3/S4/S5	Off

Connects to the power status indicator on the chassis front panel. The LED is on when the system is operating. The LED is off when the system is in S3/S4 sleep state or powered off (S5).

- **PW (Power Switch):**

Connects to the power switch on the chassis front panel. You may configure the way to turn off your system using the power switch (refer to Chapter 2, "BIOS Setup," "Settings\Platform Power," for more information).

- **SPEAK (Speaker):**

Connects to the speaker on the chassis front panel. The system reports system startup status by issuing a beep code. One single short beep will be heard if no problem is detected at system startup.

- **HD (Hard Drive Activity LED):**

Connects to the hard drive activity LED on the chassis front panel. The LED is on when the hard drive is reading or writing data.

- **RES (Reset Switch):**

Connects to the reset switch on the chassis front panel. Press the reset switch to restart the computer if the computer freezes and fails to perform a normal restart.

- **CI (Chassis Intrusion Header):**

Connects to the chassis intrusion switch/sensor on the chassis that can detect if the chassis cover has been removed. This function requires a chassis with a chassis intrusion switch/sensor.

- **NC:** No connection.



The front panel design may differ by chassis. A front panel module mainly consists of power switch, reset switch, power LED, hard drive activity LED, speaker and etc. When connecting your chassis front panel module to this header, make sure the wire assignments and the pin assignments are matched correctly.

14) F_AUDIO (Front Panel Audio Header)

The front panel audio header supports High Definition audio (HD). You may connect your chassis front panel audio module to this header. Make sure the wire assignments of the module connector match the pin assignments of the motherboard header. Incorrect connection between the module connector and the motherboard header will make the device unable to work or even damage it.



Pin No.	Definition	Pin No.	Definition
1	MIC L	6	MIC Detection
2	GND	7	SENSE_SEND
3	MIC R	8	No Pin
4	Head Phone L	9	Head Phone L
5	Head Phone R	10	Head Phone Detection



Some chassis provide a front panel audio module that has separated connectors on each wire instead of a single plug. For information about connecting the front panel audio module that has different wire assignments, please contact the chassis manufacturer.

15) F_U32C (USB Type-C® Header with USB 3.2 Gen 2 Support)

The header conforms to USB 3.2 Gen 2 specification and can provide one USB port.

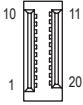

Pin No.	Definition	Pin No.	Definition	Pin No.	Definition
1	VBUS	8	CC1	15	RX2+
2	TX1+	9	SBU1	16	RX2-
3	TX1-	10	SBU2	17	GND
4	GND	11	VBUS	18	D-
5	RX1+	12	TX2+	19	D+
6	RX1-	13	TX2-	20	CC2
7	VBUS	14	GND		

16) F_U32_1/F_U32_2 (USB 3.2 Gen 1 Headers)

The headers conform to USB 3.2 Gen 1 and USB 2.0 specification and each header can provide two USB ports. For purchasing the optional 3.5" front panel that provides two USB 3.2 Gen 1 ports, please contact the local dealer.

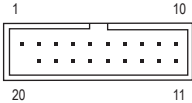

Pin No.	Definition	Pin No.	Definition	Pin No.	Definition
1	VBUS	8	D1-	15	SSTX2-
2	SSRX1-	9	D1+	16	GND
3	SSRX1+	10	NC	17	SSRX2+
4	GND	11	D2+	18	SSRX2-
5	SSTX1-	12	D2-	19	VBUS
6	SSTX1+	13	GND	20	No Pin
7	GND	14	SSTX2+		

17) F_USB1/F_USB2 (USB 2.0/1.1 Headers)

The headers conform to USB 2.0/1.1 specification. Each USB header can provide two USB ports via an optional USB bracket. For purchasing the optional USB bracket, please contact the local dealer.

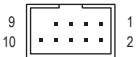

Pin No.	Definition	Pin No.	Definition
1	Power (5V)	6	USB DY+
2	Power (5V)	7	GND
3	USB DX-	8	GND
4	USB DY-	9	No Pin
5	USB DX+	10	NC



Prior to installing the USB bracket, be sure to turn off your computer and unplug the power cord from the power outlet to prevent damage to the USB bracket.

18) TPM (Trusted Platform Module Header)

You may connect a TPM (Trusted Platform Module) to this header.



Pin No.	Definition	Pin No.	Definition
1	LAD0	7	LAD3
2	VCC3	8	GND
3	LAD1	9	LFRAME
4	No Pin	10	NC
5	LAD2	11	SERIRQ
6	LCLK	12	LRESET

19) COM (Serial Port Header)

The COM header can provide one serial port via an optional COM port cable. For purchasing the optional COM port cable, please contact the local dealer.

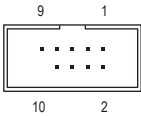

Pin No.	Definition	Pin No.	Definition
1	NDCC-	6	NDSR-
2	NSIN	7	NRTS-
3	NSOUT	8	NCTS-
4	NDTR-	9	NRI-
5	GND	10	No Pin

20) THB_C (Thunderbolt™ Add-in Card Connector)

This connector is for a GIGABYTE Thunderbolt™ add-in card.



Supports a Thunderbolt™ add-in card.

21) CLR_CMOS (Clear CMOS Jumper)

Use this jumper to clear the BIOS configuration and reset the CMOS values to factory defaults. To clear the CMOS values, use a metal object like a screwdriver to touch the two pins for a few seconds.



Open: Normal



Short: Clear CMOS Values



- Always turn off your computer and unplug the power cord from the power outlet before clearing the CMOS values.
- After system restart, go to BIOS Setup to load factory defaults (select Load Optimized Defaults) or manually configure the BIOS settings (refer to Chapter 2, "BIOS Setup," for BIOS configurations).

22) BAT (Battery)

The battery provides power to keep the values (such as BIOS configurations, date, and time information) in the CMOS when the computer is turned off. Replace the battery when the battery voltage drops to a low level, or the CMOS values may not be accurate or may be lost.

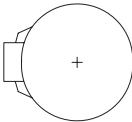

You may clear the CMOS values by removing the battery:

1. Turn off your computer and unplug the power cord.
2. Gently remove the battery from the battery holder and wait for one minute. (Or use a metal object like a screwdriver to touch the positive and negative terminals of the battery holder, making them short for 5 seconds.)
3. Replace the battery.
4. Plug in the power cord and restart your computer.



- Always turn off your computer and unplug the power cord before replacing the battery.
- Replace the battery with an equivalent one. Damage to your devices may occur if the battery is replaced with an incorrect model.
- Contact the place of purchase or local dealer if you are not able to replace the battery by yourself or uncertain about the battery model.
- When installing the battery, note the orientation of the positive side (+) and the negative side (-) of the battery (the positive side should face up).
- Used batteries must be handled in accordance with local environmental regulations.

23) CPU/DRAM/VGA/BOOT (Status LEDs)

The status LEDs show whether the CPU, memory, graphics card, and operating system are working properly after system power-on. If the CPU/DRAM/VGA LED is on, that means the corresponding device is not working normally; if the BOOT LED is on, that means you haven't entered the operating system yet.



CPU: CPU status LED



DRAM: Memory status LED



VGA: Graphics card status LED



BOOT: Operating system status LED

24) QFLASH_PLUS (Q-Flash Plus Button)

Q-Flash Plus allows you to update the BIOS when your system is off (S5 shutdown state). Save the latest BIOS on a USB thumb drive and plug it into the dedicated port, and then you can now flash the BIOS automatically by simply pressing the Q-Flash Plus button. The QFLED will flash when the BIOS matching and flashing activities start and will stop flashing when the main BIOS flashing is complete.

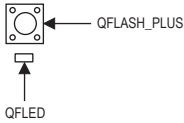

For how to use Q-Flash Plus please visit the "Unique Features" webpage of GIGABYTE's website.

25) NOISE_SENSOR (Noise Detection Header)

This header can be used to connect a noise detection cable to detect the noise inside the case.

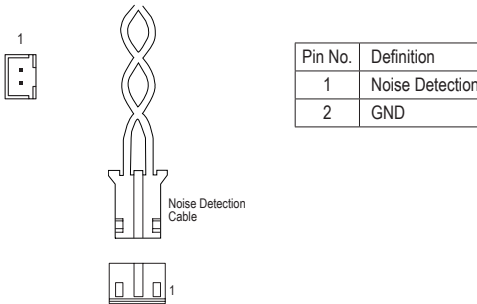

For more information on the noise detection function, please visit the "Unique Features" webpage of GIGABYTE's website.



Before connecting the cable to the header, make sure to remove the jumper cap; re-place the jumper cap if the header is not in use.

Chapter 2 BIOS Setup

BIOS (Basic Input and Output System) records hardware parameters of the system in the CMOS on the motherboard. Its major functions include conducting the Power-On Self-Test (POST) during system startup, saving system parameters and loading operating system, etc. BIOS includes a BIOS Setup program that allows the user to modify basic system configuration settings or to activate certain system features.

When the power is turned off, the battery on the motherboard supplies the necessary power to the CMOS to keep the configuration values in the CMOS.

To access the BIOS Setup program, press the <Delete> key during the POST when the power is turned on.

To upgrade the BIOS, use either the GIGABYTE Q-Flash or @BIOS utility.

- Q-Flash allows the user to quickly and easily upgrade or back up BIOS without entering the operating system.
- @BIOS is a Windows-based utility that searches and downloads the latest version of BIOS from the Internet and updates the BIOS.



- Because BIOS flashing is potentially risky, if you do not encounter problems using the current version of BIOS, it is recommended that you not flash the BIOS. To flash the BIOS, do it with caution. Inadequate BIOS flashing may result in system malfunction.
- It is recommended that you not alter the default settings (unless you need to) to prevent system instability or other unexpected results. Inadequately altering the settings may result in system's failure to boot. If this occurs, try to clear the CMOS values and reset the board to default values. (Refer to the "Load Optimized Defaults" section in this chapter or introductions of the battery/clear CMOS jumper in Chapter 1 for how to clear the CMOS values.)

2-1 Startup Screen

The following startup Logo screen will appear when the computer boots.



There are two different BIOS modes as follows and you can use the <F2> key to switch between the two modes. Easy Mode allows users to quickly view their current system information or to make adjustments for optimum performance. In Easy Mode, you can use your mouse to move through configuration items. The Advanced Mode provides detailed BIOS settings. You can press the arrow keys on your keyboard to move among the items and press <Enter> to accept or enter a sub-menu. Or you can use your mouse to select the item you want.



- When the system is not stable as usual, select the **Load Optimized Defaults** item to set your system to its defaults.
- The BIOS Setup menus described in this chapter are for reference only and may differ by BIOS version.

2-2 The Main Menu

System Time

Setup Menu

Configuration Items

Hardware Information

Option Description

Current Settings

Quick Access Bar allows you to quickly move to the General Help, Easy Mode, Smart Fan 6, or Q-Flash screen.

Advanced Mode Function Keys

<←><→>	Move the selection bar to select a setup menu
<↑><↓>	Move the selection bar to select an configuration item on a menu
<Enter>/Double Click	Execute command or enter a menu
<+>/<Page Up>	Increase the numeric value or make changes
<->/<Page Down>	Decrease the numeric value or make changes
<F1>	Show descriptions of the function keys
<F2>	Switch to Easy Mode
<F3>	Save the current BIOS settings to a profile
<F4>	Load the BIOS settings from a profile created before
<F5>	Restore the previous BIOS settings for the current submenus
<F6>	Display the Smart Fan 6 screen
<F7>	Load the Optimized BIOS default settings for the current submenus
<F8>	Access the Q-Flash utility
<F10>	Save all the changes and exit the BIOS Setup program
<F11>	Switch to the Favorites submenu
<F12>	Capture the current screen as an image and save it to your USB drive
<Insert>	Add or remove a favorite option
<Ctrl>+<S>	Display information on the installed memory
<Esc>	Main Menu: Exit the BIOS Setup program Submenus: Exit current submenu

2-3 Smart Fan 6

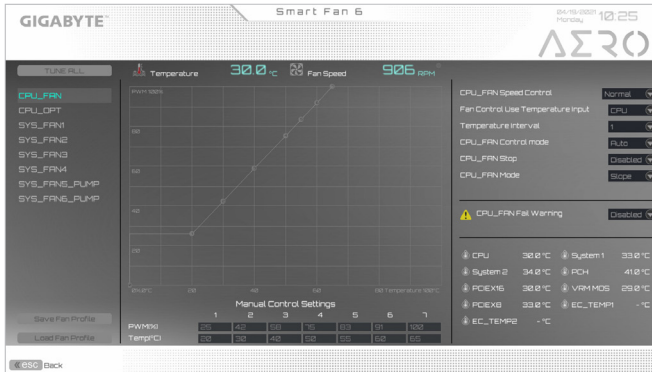

Use the <F6> function key to quickly switch to this screen. This screen allows you to configure fan speed related settings for each fan header or monitor your system/CPU temperature.

☞ TUNE ALL

Allows you to apply the current settings to all fan headers.

☞ Temperature

Displays the current temperature of the selected target area.

☞ Fan Speed

Displays current fan/pump speeds.

☞ Flow Rate

Displays the flow rate of your water cooling system. Press <Enter> on **Fan Speed** to switch to this function.

☞ Fan Speed Control

Allows you to determine whether to enable the fan speed control function and adjust the fan speed.

▶▶ Normal Allows the fan to run at different speeds according to the temperature. You can adjust the fan speed with System Information Viewer based on your system requirements. (Default)

▶▶ Silent Allows the fan to run at slow speeds.

▶▶ Manual Allows you to drag the curve nodes to adjust fan speed. Or you can use the **EZ Tuning** feature. After adjusting the node position, press **Apply** to automatically calculate the slope of the curve.

▶▶ Full Speed Allows the fan to run at full speeds.

☞ Fan Control Use Temperature Input

Allows you to select the reference temperature for fan speed control.

☞ Temperature Interval

Allows you to select the temperature interval for fan speed change.

☞ FAN/PUMP Control Mode

▶▶ Auto Lets the BIOS automatically detect the type of fan installed and sets the optimal control mode. (Default)

▶▶ Voltage Voltage mode is recommended for a 3-pin fan/pump.

▶▶ PWM PWM mode is recommended for a 4-pin fan/pump.

☞ **FAN/PUMP Stop**

Enables or disables the fan/pump stop function. You can set the temperature limit using the temperature curve. The fan or pump stops operation when the temperature is lower than the limit. (Default: Disabled)

☞ **FAN/PUMP Mode**

Allows you to set the operating mode for the fan.

- ▶▶ Slope Adjusts the fan speed linearly based on the temperature. (Default)
- ▶▶ Stair Adjusts the fan speed stepwise based on the temperature.

☞ **FAN/PUMP Fail Warning**

Allows the system to emit warning sound if the fan/pump is not connected or fails. Check the fan/pump condition or fan/pump connection when this occurs. (Default: Disabled)

☞ **Save Fan Profile**

This function allows you to save the current settings to a profile. You can save the profile in the BIOS or select **Select File in HDD/FDD/USB** to save the profile to your storage device.

☞ **Load Fan Profile**

This function allows you to load a previously saved BIOS profile without the hassles of reconfiguring the BIOS settings. Or you can select **Select File in HDD/FDD/USB** to load a profile from your storage device.

2-4 Favorites (F11)



Set your frequently used options as your favorites and use the <F11> key to quickly switch to the page where all of your favorite options are located. To add or remove a favorite option, go to its original page and press <Insert> on the option. The option is marked with a star sign if set as a "favorite."

2-5 Tweaker

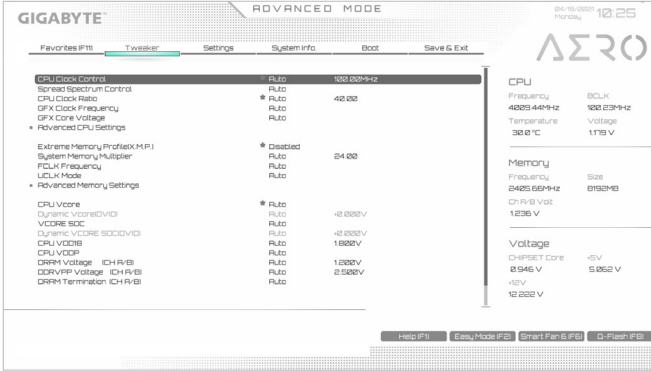

Whether the system will work stably with the overclock/overvoltage settings you made is dependent on your overall system configurations. Incorrectly doing overclock/overvoltage may result in damage to CPU, chipset, or memory and reduce the useful life of these components. This page is for advanced users only and we recommend you not to alter the default settings to prevent system instability or other unexpected results. (Inadequately altering the settings may result in system's failure to boot. If this occurs, clear the CMOS values and reset the board to default values.)

⦿ CPU Clock Control

Allows you to manually set the CPU base clock in 1 MHz increments. (Default: Auto)

Important: It is highly recommended that the CPU frequency be set in accordance with the CPU specifications.

⦿ Spread Spectrum Control

Enables or disables CPU/PCIe Spread Spectrum. (Default: Auto)

⦿ CPU Ratio Mode ^(Note)

Allows you to set the core ratio for all CPU cores or individual cores. (Default: All cores)

⦿ CCD0 CCX0/1 Ratio ^(Note)

Allows you to manually set the core ratio for the CPU CCX0, 1 cores. This item is configurable only when **CPU Ratio Mode** is set to **Per CCX**. (Default: Auto)

⦿ CPU Clock Ratio

Allows you to alter the clock ratio for the installed CPU. The adjustable range is dependent on the CPU being installed.

⦿ GFX Clock Frequency ^(Note)

Allows you to alter the frequency for the GPU. After you alter the **GFX Clock Frequency** settings, make sure to adjust the **GFX Core Voltage** settings. (Default: Auto)

NOTE: The adjustable range is dependent on the CPU being installed. **Auto** lets the BIOS automatically configure this setting.

⦿ GFX Core Voltage ^(Note)

Allows you to alter the voltage for the GPU. (Default: Auto)

NOTE: The adjustable range is dependent on the CPU being installed. **Auto** lets the BIOS automatically configure this setting.

(Note) This item is present only when you install a CPU that supports this feature.

■ Advanced CPU Settings

☞ Core Performance Boost ^(Note 1)

Allows you to determine whether to enable the Core Performance Boost (CPB) technology, a CPU performance-boost technology. (Default: Auto)

☞ SVM Mode

Virtualization enhanced by Virtualization Technology will allow a platform to run multiple operating systems and applications in independent partitions. With virtualization, one computer system can function as multiple virtual systems. (Default: Disabled)

☞ AMD Cool&Quiet function

- ▶▶ Enabled Lets the AMD Cool'n'Quiet driver dynamically adjust the CPU clock and VID to reduce heat output from your computer and its power consumption. (Default)
- ▶▶ Disabled Disables this function.

☞ PPC Adjustment ^(Note 1)

Allows you to fix the PState of the CPU. (Default: PState 0)

☞ Global C-state Control ^(Note 1)

Allows you to determine whether to let the CPU enter C states. When enabled, the CPU core frequency will be reduced during system halt state to decrease power consumption. (Default: Enabled)

☞ Power Supply Idle Control ^(Note 1)

Enables or disables Package C6 State.

- ▶▶ Typical Current Idle Disables this function.
- ▶▶ Low Current Idle Enables this function.
- ▶▶ Auto Lets the BIOS automatically configure this setting. (Default)

☞ CCD Control ^(Note 1)

Sets the number of CCDs to be used. (Default: Auto)

☞ Downcore Control

Allows you to select the number of CPU cores to enable (the number of CPU cores may vary by CPU). (Default: Auto)

☞ SMT Mode

Allows you to enable or disable the CPU Simultaneous Multi-Threading technology. (Default: Auto)

☞ CPPC ^(Note 1)

Enables or disables the CPPC feature. (Default: Auto)

☞ CPPC Preferred Cores ^(Note 1)

Enables or disables the CPPC Preferred Cores feature. (Default: Auto)

☞ Active OC Tuner ^(Note 1)

Enables or disables the Active OC Tuner feature. (Default: Disabled)

☞ Extreme Memory Profile (X.M.P.) ^(Note 2)

Allows the BIOS to read the SPD data on XMP memory module(s) to enhance memory performance when enabled.

- ▶▶ Disabled Disables this function. (Default)
- ▶▶ Profile1 Uses Profile 1 settings.
- ▶▶ Profile2 ^(Note 2) Uses Profile 2 settings.

☞ XMP High Frequency Support ^(Note 2)

Allows you to select the compatibility level for high-frequency memory. This item is configurable only when **Extreme Memory Profile (X.M.P.)** is set to **Profile1** or **Profile2**. (Default: Auto)

(Note 1) This item is present only when you install a CPU that supports this feature.

(Note 2) This item is present only when you install a CPU and a memory module that support this feature.

↪ **System Memory Multiplier**

Allows you to set the system memory multiplier. **Auto** sets memory multiplier according to memory SPD data. (Default: Auto)

↪ **FCLK Frequency**

Allows you to set the FCLK frequency. Options are: Auto (default), 667MHz~4000MHz.

↪ **UCLK Mode**

Allows you to specify the UCLK mode. (Default: Auto)

■ **Advanced Memory Settings**

■ **Memory Subtimings**

▼ **Standard Timing Control, Advanced Timing Control, CAD Bus Setup Timing, CAD Bus Drive Strength, Data Bus Configuration**

These sections provide memory timing settings. Note: Your system may become unstable or fail to boot after you make changes on the memory timings. If this occurs, please reset the board to default values by loading optimized defaults or clearing the CMOS values.

■ **SPD Info**

Displays information on the installed memory.

↪ **Power Down Enable**

Enables or disables Power Down support. (Default: Auto)

↪ **CPU Vcore/Dynamic Vcore(DVID)/VCORE SOC/Dynamic VCORE SOC(DVID)/CPU VDD18/
CPU VDDP/DRAM Voltage (CH A/B)/DDRVPP Voltage (CH A/B)/DRAM Termination (CH A/B)/
VDDP Voltage Control^(Note)/VDDG Voltage Control^(Note)**

These items allow you to adjust the CPU Vcore and memory voltages.

■ **CPU/VRM Settings**

This submenu allows you to configure Load-Line Calibration level.

(Note) This item is present only when you install a CPU that supports this feature.

2-6 Settings



■ Platform Power

☞ AC BACK

Determines the state of the system after the return of power from an AC power loss.

- ▶▶ Memory The system returns to its last known awake state upon the return of the AC power.
- ▶▶ Always On The system is turned on upon the return of the AC power.
- ▶▶ Always Off The system stays off upon the return of the AC power. (Default)

☞ ErP

Determines whether to let the system consume least power in S5 (shutdown) state. (Default: Disabled)

Note: When this item is set to **Enabled**, the Resume by Alarm function becomes unavailable.

☞ Soft-Off by PWR-BTTN

Configures the way to turn off the computer in MS-DOS mode using the power button.

- ▶▶ Instant-Off Press the power button and then the system will be turned off instantly. (Default)
- ▶▶ Delay 4 Sec. Press and hold the power button for 4 seconds to turn off the system. If the power button is pressed for less than 4 seconds, the system will enter suspend mode.

☞ Power Loading

Enables or disables dummy load. When the power supply is at low load, a self-protection will activate causing it to shutdown or fail. If this occurs, please set to **Enabled**. **Auto** lets the BIOS automatically configure this setting. (Default: Auto)

☞ Resume by Alarm

Determines whether to power on the system at a desired time. (Default: Disabled)

If enabled, set the date and time as following:

- ▶▶ Wake up day: Turn on the system at a specific time on each day or on a specific day in a month.
 - ▶▶ Wake up hour/minute/second: Set the time at which the system will be powered on automatically.
- Note: When using this function, avoid inadequate shutdown from the operating system or removal of the AC power, or the settings may not be effective.

☞ High Precision Event Timer

Enables or disables High Precision Event Timer (HPET) in the operating system. (Default: Enabled)

■ IO Ports

☞ Initial Display Output

Specifies the first initiation of the monitor display from the installed PCI Express graphics card or the onboard graphics.

- ▶▶ IGD Video ^(Note) Sets the onboard graphics as the first display.
- ▶▶ PCIe 1 Slot Sets the graphics card on the PCIe16 slot as the first display. (Default)
- ▶▶ PCIe 2 Slot Sets the graphics card on the PCIeX8 slot as the first display.
- ▶▶ PCIe 3 Slot Sets the graphics card on the PCIeX4 slot as the first display.

☞ Integrated Graphics ^(Note)

Enables or disables the onboard graphics function.

- ▶▶ Auto The BIOS will automatically enable or disable the onboard graphics depending on the graphics card being installed. (Default)
- ▶▶ Forces Enables the onboard graphics.
- ▶▶ Disabled Disables the onboard graphics.

☞ UMA Mode ^(Note)

Specify the UMA mode.

- ▶▶ Auto Lets the BIOS automatically configure this setting. (Default)
- ▶▶ UMA Specified Sets the UMA Frame Buffer Size.
- ▶▶ UMA Auto Sets the display resolution.
- ▶▶ UMA Game Optimized Adjusts the frame buffer size based on the total system memory size.

This item is configurable only when **Integrated Graphics** is set to **Forces**.

☞ UMA Frame Buffer Size ^(Note)

Frame buffer size is the total amount of system memory allocated solely for the onboard graphics controller. MS-DOS, for example, will use only this memory for display. Options are: Auto (default), 64M-2G. This item is configurable only when **UMA Mode** is set to **UMA Specified**.

☞ Display Resolution ^(Note)

Allows you to set the display resolution. Options are: Auto (default), 1920x1080 and below, 2560x1600, 3840x2160. This item is configurable only when **UMA Mode** is set to **UMA Auto**.

☞ HD Audio Controller

Enables or disables the onboard audio function. (Default: Enabled)

If you wish to install a 3rd party add-in audio card instead of using the onboard audio, set this item to **Disabled**.

☞ PCIe16 Bifurcation

Allows you to determine how the bandwidth of the PCIe16 slot is divided. Options: Auto, PCIe 2x8, PCIe 1x8/2x4, PCIe 2x4/1x8 ^(Note), PCIe 4x4 ^(Note). (Default: Auto)

☞ Above 4G Decoding

Enables or disables 64-bit capable devices to be decoded in above 4 GB address space (only if your system supports 64-bit PCI decoding). Set to **Enabled** if more than one advanced graphics card are installed and their drivers are not able to be launched when entering the operating system (because of the limited 4 GB memory address space). (Default: Disabled)

☞ Re-Size BAR Support

Enables or disables support for Resizable BAR. (Default: Disabled)

☞ F_U32C Gen Speed

Allows you to set the operation mode of the F_U32C header to Gen 1 or Gen 2 ^(Note). Actual operation mode is subject to the hardware specification of each header. (Default: Auto)

(Note) This item is present only when you install a CPU that supports this feature.

☞ **Onboard LAN Controller**

Enables or disables the onboard LAN function. (Default: Enabled)

If you wish to install a 3rd party add-in network card instead of using the onboard LAN, set this item to **Disabled**.

■ **USB Type-C with Titan Ridge Configuration**

This sub-menu provides USB Type-C® ports related information and configuration options.

■ **Super IO Configuration**

☞ **Serial Port 1**

Enables or disables the onboard serial port. (Default: Enabled)

■ **USB Configuration**

☞ **Legacy USB Support**

Allows USB keyboard/mouse to be used in MS-DOS. (Default: Enabled)

☞ **XHCI Hand-off**

Determines whether to enable XHCI Hand-off feature for an operating system without XHCI Hand-off support. (Default: Enabled)

☞ **USB Mass Storage Driver Support**

Enables or disables support for USB storage devices. (Default: Enabled)

☞ **Port 60/64 Emulation**

Enables or disables emulation of I/O ports 64h and 60h. This should be enabled for full legacy support for USB keyboards/mice in MS-DOS or in operating system that does not natively support USB devices. (Default: Disabled)

☞ **Mass Storage Devices**

Displays a list of connected USB mass storage devices. This item appears only when a USB storage device is installed.

■ **NVMe Configuration**

Displays information on your M.2 NVMe PCIe SSD if installed.

■ **SATA Configuration**

☞ **SATA Mode**

Enables or disables RAID for the SATA controllers integrated in the Chipset or configures the SATA controllers to AHCI mode.

▶▶ RAID Enables RAID for the SATA controller.

▶▶ AHCI Configures the SATA controllers to AHCI mode. Advanced Host Controller Interface (AHCI) is an interface specification that allows the storage driver to enable advanced Serial ATA features such as Native Command Queuing and hot plug. (Default)

☞ **NVMe RAID mode**

Allows you to determine whether to use your M.2 NVMe PCIe SSDs to configure RAID. (Default: Disabled)

☞ **Chipset SATA Port Enable**

Enables or disables the integrated SATA controllers. (Default: Enabled)

☞ **Chipset SATA Port Hot Plug**

Enables or disable the hot plug capability for each SATA port. (Default: Enabled)

☞ **Chipset SATA Port 0/1/2/3/4/5**

Displays the information of the connected SATA device(s).

■ Network Stack Configuration

☞ Network Stack

Disables or enables booting from the network to install a GPT format OS, such as installing the OS from the Windows Deployment Services server. (Default: Disabled)

☞ IPv4 PXE Support

Enables or disables IPv4 PXE Support. This item is configurable only when **Network Stack** is enabled.

☞ IPv4 HTTP Support

Enables or disables HTTP boot support for IPv4. This item is configurable only when **Network Stack** is enabled.

☞ IPv6 PXE Support

Enables or disables IPv6 PXE Support. This item is configurable only when **Network Stack** is enabled.

☞ IPv6 HTTP Support

Enables or disables HTTP boot support for IPv6. This item is configurable only when **Network Stack** is enabled.

☞ PXE boot wait time

Allows you to configure how long to wait before you can press <Esc> to abort the PXE boot. This item is configurable only when **Network Stack** is enabled. (Default: 0)

☞ Media detect count

Allows you to set the number of times to check the presence of media. This item is configurable only when **Network Stack** is enabled. (Default: 1)

■ Intel(R) Ethernet Controller

This sub-menu provides information on LAN configuration and related configuration options.

■ Miscellaneous

☞ LEDs in System Power On State

Allows you to enable or disable motherboard LED lighting when the system is on.

- ▶▶ Off Disables the selected lighting mode when the system is on.
- ▶▶ On Enables the selected lighting mode when the system is on. (Default)

☞ LEDs in Sleep, Hibernation, and Soft Off States

Allows you to set the lighting mode of the motherboard LEDs in system S3/S4/S5 state.

This item is configurable when **LEDs in System Power On State** is set to **On**.

- ▶▶ Off Disables the selected lighting mode when the system enters S3/S4/S5 state. (Default)
- ▶▶ On Enables the selected lighting mode when the system enters S3/S4/S5 state.

☞ PCIEX16 Slot Configuration

Allows you to set the operation mode of the PCIEX16 slot to Gen 1, Gen 2, Gen 3, or Gen 4^(Note). **Auto** lets the BIOS automatically configure this setting. (Default: Auto)

☞ PCIe Slot Configuration

Allows you to set the operation mode of the PCI Express slots and M.2 connectors to Gen 1, Gen 2, Gen 3, or Gen 4^(Note). Actual operation mode is subject to the hardware specification of each slot. **Auto** lets the BIOS automatically configure this setting. (Default: Auto)

☞ PCIe ASPM Mode

Allows you to configure the ASPM mode for the device connected to CPU/Chipset's PCI Express bus. (Default: Disabled)

(Note) This item is present only when you install a CPU that supports this feature.

↳ **3DMark01 Enhancement**

Allows you to determine whether to enhance some legacy benchmark performance. (Default: Disabled)

↳ **IOMMU**

Enables or disables AMD IOMMU support. (Default: Auto)

↳ **TSME**

Enables or disables TSME support. (Default: Auto)

↳ **AMD CPU fTPM**

Enables or disables the TPM 2.0 function integrated in the AMD CPU. (Default: Disabled)

■ **Trusted Computing**

Enables or disables Trusted Platform Module (TPM).

■ **AMD CBS**

This sub-menu provides AMD CBS-related configuration options.

■ **PC Health**

↳ **Reset Case Open Status**

- ▶ Disabled Keeps or clears the record of previous chassis intrusion status. (Default)
- ▶ Enabled Clears the record of previous chassis intrusion status and the **Case Open** field will show "No" at next boot.

↳ **Case Open**

Displays the detection status of the chassis intrusion detection device attached to the motherboard CI header. If the system chassis cover is removed, this field will show "Yes", otherwise it will show "No". To clear the chassis intrusion status record, set **Reset Case Open Status** to **Enabled**, save the settings to the CMOS, and then restart your system.

↳ **CPU Vcore/CPU VDDP/CPU VDD18/DRAM Channel A/B Voltage/PM_CLDO12/ +3.3V/+5V/CHIPSET Core/+12V/VCORE SOC**

Displays the current system voltages.

2-7 System Info.

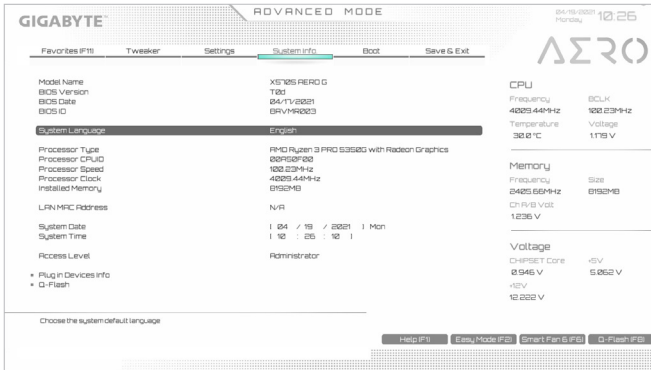

This section provides information on your motherboard model and BIOS version. You can also select the default language used by the BIOS and manually set the system time.

System Language

Selects the default language used by the BIOS.

System Date

Sets the system date. The date format is week (read-only), month, date, and year. Use <Enter> to switch between the Month, Date, and Year fields and use the <Page Up> or <Page Down> key to set the desired value.

System Time

Sets the system time. The time format is hour, minute, and second. For example, 1 p.m. is 13:00:00. Use <Enter> to switch between the Hour, Minute, and Second fields and use the <Page Up> or <Page Down> key to set the desired value.

Access Level

Displays the current access level depending on the type of password protection used. (If no password is set, the default will display as **Administrator**.) The Administrator level allows you to make changes to all BIOS settings; the User level only allows you to make changes to certain BIOS settings but not all.

Plug in Devices Info

Displays information on your SATA, PCI Express, and M.2 devices if installed.

Q-Flash

Allows you to access the Q-Flash utility to update the BIOS or back up the current BIOS configuration.

2-8 Boot

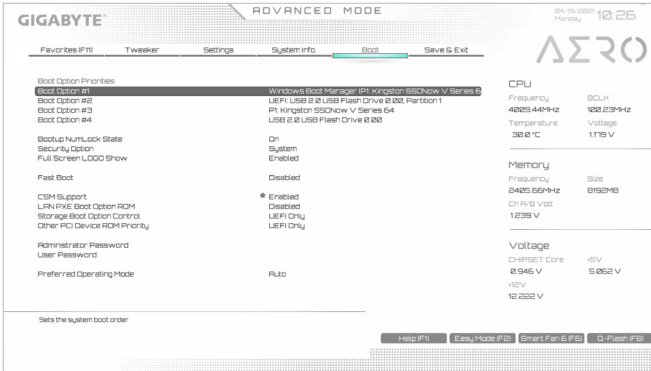

Boot Option Priorities

Specifies the overall boot order from the available devices. Removable storage devices that support GPT format will be prefixed with "UEFI:" string on the boot device list. To boot from an operating system that supports GPT partitioning, select the device prefixed with "UEFI:" string.

Or if you want to install an operating system that supports GPT partitioning such as Windows 10 64-bit, select the optical drive that contains the Windows 10 64-bit installation disc and is prefixed with "UEFI:" string.

Bootup NumLock State

Enables or disables Numlock feature on the numeric keypad of the keyboard after the POST. (Default: On)

Security Option

Specifies whether a password is required every time the system boots, or only when you enter BIOS Setup. After configuring this item, set the password(s) under the **Administrator Password/User Password** item.

- ▶▶ Setup A password is only required for entering the BIOS Setup program.
- ▶▶ System A password is required for booting the system and for entering the BIOS Setup program. (Default)

Full Screen LOGO Show

Allows you to determine whether to display the GIGABYTE Logo at system startup. **Disabled** skips the GIGABYTE Logo when the system starts up. (Default: Enabled)

Fast Boot

Enables or disables Fast Boot to shorten the OS boot process. **Ultra Fast** provides the fastest bootup speed. (Default: Disabled)

SATA Support

- ▶▶ Last Boot SATA Devices Only Except for the previous boot drive, all SATA devices are disabled before the OS boot process completes. (Default)
- ▶▶ All SATA Devices All SATA devices are functional in the operating system and during the POST. This item is configurable only when **Fast Boot** is set to **Enabled** or **Ultra Fast**.

NVMe Support

Allows you to enable or disable NVMe device(s). (Default: Enabled)

This item is configurable only when **Fast Boot** is set to **Enabled** or **Ultra Fast**.

⊞ **VGA Support**

Allows you to select which type of operating system to boot.

- ▶▶ Auto Enables legacy option ROM only.
- ▶▶ EFI Driver Enables EFI option ROM. (Default)

This item is configurable only when **Fast Boot** is set to **Enabled** or **Ultra Fast**.

⊞ **USB Support**

- ▶▶ Disabled All USB devices are disabled before the OS boot process completes.
- ▶▶ Full Initial All USB devices are functional in the operating system and during the POST. (Default)
- ▶▶ Partial Initial Part of the USB devices are disabled before the OS boot process completes.

This item is configurable only when **Fast Boot** is set to **Enabled** or **Ultra Fast**. This function is disabled when **Fast Boot** is set to **Ultra Fast**.

⊞ **NetWork Stack Driver Support**

- ▶▶ Disabled Disables booting from the network. (Default)
- ▶▶ Enabled Enables booting from the network.

This item is configurable only when **Fast Boot** is set to **Enabled** or **Ultra Fast**.

⊞ **CSM Support**

Enables or disables UEFI CSM (Compatibility Support Module) to support a legacy PC boot process.

- ▶▶ Disabled Disables UEFI CSM and supports UEFI BIOS boot process only.
- ▶▶ Enabled Enables UEFI CSM. (Default)

⊞ **LAN PXE Boot Option ROM**

Allows you to select whether to enable the legacy option ROM for the LAN controller. (Default: Disabled)

This item is configurable only when **CSM Support** is set to **Enabled**.

⊞ **Storage Boot Option Control**

Allows you to select whether to enable the UEFI or legacy option ROM for the storage device controller.

- ▶▶ Disabled Disables option ROM.
- ▶▶ UEFI Only Enables UEFI option ROM only. (Default)
- ▶▶ Legacy Only Enables legacy option ROM only.

This item is configurable only when **CSM Support** is set to **Enabled**.

⊞ **Other PCI Device ROM Priority**

Allows you to select whether to enable the UEFI or Legacy option ROM for the PCI device controller other than the LAN, storage device, and graphics controllers.

- ▶▶ Disabled Disables option ROM.
- ▶▶ UEFI Only Enables UEFI option ROM only. (Default)
- ▶▶ Legacy Only Enables legacy option ROM only.

This item is configurable only when **CSM Support** is set to **Enabled**.

⊞ **Administrator Password**

Allows you to configure an administrator password. Press <Enter> on this item, type the password, and then press <Enter>. You will be requested to confirm the password. Type the password again and press <Enter>. You must enter the administrator password (or user password) at system startup and when entering BIOS Setup. Differing from the user password, the administrator password allows you to make changes to all BIOS settings.

↳ **User Password**

Allows you to configure a user password. Press <Enter> on this item, type the password, and then press <Enter>. You will be requested to confirm the password. Type the password again and press <Enter>. You must enter the administrator password (or user password) at system startup and when entering BIOS Setup. However, the user password only allows you to make changes to certain BIOS settings but not all. To cancel the password, press <Enter> on the password item and when requested for the password, enter the correct one first. When prompted for a new password, press <Enter> without entering any password. Press <Enter> again when prompted to confirm.

NOTE: Before setting the User Password, be sure to set the Administrator Password first.

■ **Secure Boot**

Allows you to enable or disable Secure Boot and configure related settings. This item is configurable only when **CSM Support** is set to **Disabled**.

↳ **Preferred Operating Mode**

Allows you to select whether to enter Easy mode or Advanced mode after entering BIOS Setup. **Auto** enters the BIOS mode where it was last time. (Default: Auto)

2-9 Save & Exit

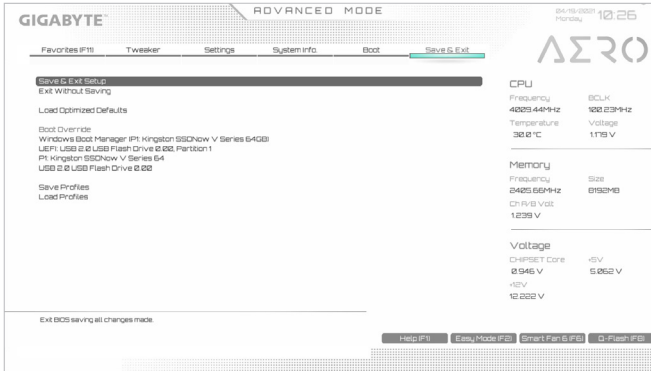

Save & Exit Setup

Press <Enter> on this item and select **Yes**. This saves the changes to the CMOS and exits the BIOS Setup program. Select **No** or press <Esc> to return to the BIOS Setup Main Menu.

Exit Without Saving

Press <Enter> on this item and select **Yes**. This exits the BIOS Setup without saving the changes made in BIOS Setup to the CMOS. Select **No** or press <Esc> to return to the BIOS Setup Main Menu.

Load Optimized Defaults

Press <Enter> on this item and select **Yes** to load the optimal BIOS default settings. The BIOS default settings help the system to operate in optimum state. Always load the Optimized defaults after updating the BIOS or after clearing the CMOS values.

Boot Override

Allows you to select a device to boot immediately. Press <Enter> on the device you select and select **Yes** to confirm. Your system will restart automatically and boot from that device.

Save Profiles

This function allows you to save the current BIOS settings to a profile. You can create up to 8 profiles and save as Setup Profile 1~ Setup Profile 8. Press <Enter> to complete. Or you can select **Select File in HDD/FDD/USB** to save the profile to your storage device.

Load Profiles

If your system becomes unstable and you have loaded the BIOS default settings, you can use this function to load the BIOS settings from a profile created before, without the hassles of reconfiguring the BIOS settings. First select the profile you wish to load and then press <Enter> to complete. You can select **Select File in HDD/FDD/USB** to input the profile previously created from your storage device or load the profile automatically created by the BIOS, such as reverting the BIOS settings to the last settings that worked properly (last known good record).

Chapter 3 Appendix

3-1 Configuring a RAID Set

RAID Levels

	RAID 0	RAID 1	RAID 10
Minimum Number of Hard Drives	≥2	2	4
Array Capacity	Number of hard drives * Size of the smallest drive	Size of the smallest drive	(Number of hard drives/2) * Size of the smallest drive
Fault Tolerance	No	Yes	Yes

Before you begin, please prepare the following items:

- At least two SATA hard drives or SSDs. ^(Note 1) (To ensure optimal performance, it is recommended that you use two hard drives with identical model and capacity). ^(Note 2)
- Windows setup disc.
- Motherboard driver disc.
- A USB thumb drive.

Configuring the Onboard SATA Controller

A. Installing SATA hard drive(s) in your computer

Install the hard drives/SSDs in the SATA/M.2 connectors on the motherboard. Then connect the power connectors from your power supply to the hard drives.

B. Configuring SATA controller mode in BIOS Setup

Make sure to configure the SATA controller mode correctly in system BIOS Setup.

Steps:

Turn on your computer and press <Delete> to enter BIOS Setup during the POST (Power-On Self-Test). Under **Settings\IO Ports**, set **SATA Configuration\SATA Mode** to **RAID**. Then save the settings and restart your computer. (If you want to use NVMe PCIe SSDs to configure RAID, make sure to set **NVMe RAID mode** to **Enabled**.)



The BIOS Setup menus described in this section may differ from the exact settings for your motherboard. The actual BIOS Setup menu options you will see shall depend on the motherboard you have and the BIOS version.

(Note 1) An M.2 PCIe SSD cannot be used to set up a RAID set either with an M.2 SATA SSD or a SATA hard drive.

(Note 2) Refer to "1-8 Internal Connectors," for the installation notices for the M.2 and SATA connectors.

C. UEFI RAID Configuration

Steps:

1. In BIOS Setup, go to **Boot** and set **CSM Support** to **Disabled**. Save the changes and exit BIOS Setup.
2. After the system reboot, enter BIOS Setup again. Then enter the **Settings\RAIDXpert2 Configuration Utility** sub-menu.
3. On the **RAIDXpert2 Configuration Utility** screen, press <Enter> on **Array Management** to enter the **Create Array** screen. Then, select a RAID level. RAID levels supported include RAID 0, RAID 1, and RAID 10 (the selections available depend on the number of the hard drives being installed). Next, press <Enter> on **Select Physical Disks** to enter the **Select Physical Disks** screen.
4. On the **Select Physical Disks** screen, select the hard drives to be included in the RAID array and set them to **Enabled**. Next, use the down arrow key to move to **Apply Changes** and press <Enter>. Then return to the previous screen and set the **Array Size**, **Array Size Unit**, **Read Cache Policy** and **Write Cache Policy**.
5. After setting the capacity, move to **Create Array** and press <Enter> to begin.
6. After completing, you'll be brought back to the **Array Management** screen. Under **Manage Array Properties** you can see the new RAID volume and information on RAID level, array name, array capacity, etc.
<https://www.gigabyte.com/WebPage/454/x570-aorus-raid.html>

Install the RAID driver and operating system

With the correct BIOS settings, you are ready to install the operating system.

Installing the Operating System

As some operating systems already include RAID driver, you do not need to install separate RAID driver during the Windows installation process. After the operating system is installed, we recommend that you install all required drivers from the motherboard driver disc using "Xpress Install" to ensure system performance and compatibility. If the operating system to be installed requires that you provide additional RAID driver during the OS installation process, please refer to the steps below:

1. Copy the **Hw10** folder under the **\BootDrv** folder in the driver disc to your USB thumb drive.
2. Boot from the Windows setup disc and perform standard OS installation steps. When the screen requesting you to load the driver appears, select **Browse**.
3. Insert the USB thumb drive and then browse to the location of the driver. Select **AMD-RAID Bottom Device** first and click **Next** to load the driver. Then select **AMD-RAID Controller** and click **Next** to load the driver. Finally, continue the OS installation.

☞ Please visit GIGABYTE's website for details on configuring a RAID array.

<https://www.gigabyte.com/WebPage/454/x570-aorus-raid.html>

3-2 Drivers Installation



- Before installing the drivers, first install the operating system.
- After installing the operating system, insert the motherboard driver disc into your optical drive. Click on the message "Tap to choose what happens with this disc" on the top-right corner of the screen and select "Run Run.exe." (Or go to My Computer, double-click the optical drive and execute the Run.exe program.)

"Xpress Install" will automatically scan your system and then list all of the drivers that are recommended to install. You can click the **Xpress Install** button and "Xpress Install" will install all of the selected drivers. Or click the arrow  icon to individually install the drivers you need.

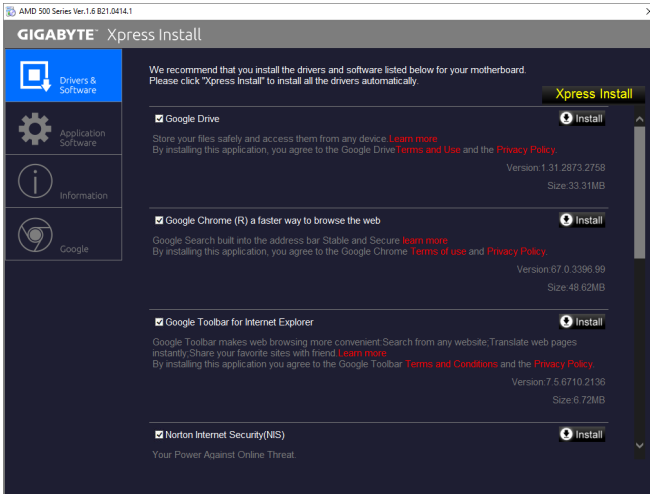

➤ Please visit GIGABYTE's website for more software information.
<https://www.gigabyte.com/WebPage/412/x570-app.html>

➤ Please visit GIGABYTE's website for more troubleshooting information.
<https://www.gigabyte.com/WebPage/351/faq.html>

Regulatory Notices

United States of America, Federal Communications Commission Statement

Supplier's Declaration of Conformity 47 CFR § 2.1077 Compliance Information

Product Name: **Motherboard**
Trade Name: **GIGABYTE**
Model Number: **X570S AERO G**

Responsible Party – U.S. Contact Information: **G.B.T. Inc.**
Address: 17358 Railroad street, City Of Industry, CA91748
Tel.: 1-626-854-9338
Internet contact information: <https://www.gigabyte.com>

FCC Compliance Statement:

This device complies with Part 15 of the FCC Rules, Subpart B, Unintentional Radiators. Operation is subject to the following two conditions: (1) This device may not cause harmful interference, and (2) this device must accept any interference received, including interference that may cause undesired operation.

The FCC with its action in ET Docket 96-8 has adopted a safety standard for human exposure to radio frequency (RF) electromagnetic energy emitted by FCC certified equipment. The Intel PRO/Wireless 5000 LAN products meet the Human Exposure limits found in OET Bulletin 65, 2001, and ANSI/IEEE C95.1, 1992. Proper operation of this radio according to the instructions found in this manual will result in exposure substantially below the FCC's recommended limits.

The following safety precautions should be observed:

- Do not touch or move antenna while the unit is transmitting or receiving.
- Do not hold any component containing the radio such that the antenna is very close or touching any exposed parts of the body, especially the face or eyes, while transmitting.
- Do not operate the radio or attempt to transmit data unless the antenna is connected; if not, the radio may be damaged.
- Use in specific environments:
 - The use of wireless devices in hazardous locations is limited by the constraints posed by the safety directors of such environments.
 - The use of wireless devices on airplanes is governed by the Federal Aviation Administration (FAA).
 - The use of wireless devices in hospitals is restricted to the limits set forth by each hospital.

Antenna use:

In order to comply with FCC RF exposure limits, low gain integrated antennas should be located at a minimum distance of 7.9 inches (20 cm) or more from the body of all persons.

Explosive Device Proximity Warning

Warning: Do not operate a portable transmitter (such as a wireless network device) near unshielded blasting caps or in an explosive environment unless the device has been modified to be qualified for such use.

Antenna Warning

The wireless adapter is not designed for use with high-gain antennas.

Use On Aircraft Caution

Caution: Regulations of the FCC and FAA prohibit airborne operation of radio-frequency wireless devices because their signals could interfere with critical aircraft instruments.

Other Wireless Devices

Safety Notices for Other Devices in the Wireless Network: Refer to the documentation supplied with wireless Ethernet adapters or other devices in the wireless network.

Canada, Canada-Industry Notice:

This device complies with Industry Canada license-exempt RSS standard(s). Operation is subject to the following two conditions:

- (1) this device may not cause interference, and
 - (2) this device must accept any interference, including interference that may cause undesired operation of the device.
- Cet appareil est conforme aux normes Canada d'industrie de RSS permis-exempt. L'utilisation est assujéti aux deux conditions suivantes: (1) le dispositif ne doit pas produire de brouillage préjudiciable, et (2) ce dispositif doit accepter tout brouillage reçu, y compris un brouillage susceptible de provoquer un fonctionnement indésirable.

Caution: When using IEEE 802.11a wireless LAN, this product is restricted to indoor use due to its operation in the 5.15-to 5.25-GHz frequency range. Industry Canada requires this product to be used indoors for the frequency range of 5.15 GHz to 5.25 GHz to reduce the potential for harmful interference to co-channel mobile satellite systems. High power radar is allocated as the primary user of the 5.25-to 5.35-GHz and 5.65 to 5.85-GHz bands. These radar stations can cause interference with and/or

damage to this device. The maximum allowed antenna gain for use with this device is 6dBi in order to comply with the E.I.R.P limit for the 5.25-to 5.35 and 5.725 to 5.85 GHz frequency range in point-to-point operation. To comply with RF exposure requirements all antennas should be located at a minimum distance of 20cm, or the minimum separation distance allowed by the module approval, from the body of all persons.

Attention: l'utilisation d'un réseau sans fil IEEE802.11a est restreinte à une utilisation en intérieur à cause du fonctionnement dans la bande de fréquence 5.15-5.25 GHz. Industry Canada requiert que ce produit soit utilisé à l'intérieur des bâtiments pour la bande de fréquence 5.15-5.25 GHz afin de réduire les possibilités d'interférences nuisibles aux canaux co-existants des systèmes de transmission satellites. Les radars de puissances ont fait l'objet d'une allocation primaire de fréquences dans les bandes 5.25-5.35 GHz et 5.65-5.85 GHz. Ces stations radar peuvent créer des interférences avec ce produit et/ou lui être nuisible. Le gain d'antenne maximum permise pour une utilisation avec ce produit est de 6 dBi afin d'être conforme aux limites de puissance isotropique rayonnée équivalente (P.I.R.E.) applicable dans les bandes 5.25-5.35 GHz et 5.725-5.85 GHz en fonctionnement point-à-point. Pour se conformer aux conditions d'exposition de RF toutes les antennes devraient être localisées à une distance minimum de 20 cm, ou la distance de séparation minimum permise par l'approbation du module, du corps de toutes les personnes.

Under Industry Canada regulations, this radio transmitter may only operate using an antenna of a type and maximum (or lesser) gain approved for the transmitter by Industry Canada. To reduce potential radio interference to other users, the antenna type and its gain should be chosen so that the equivalent isotropically radiated power (e.i.r.p.) is not more than that necessary for successful communication.

Conformément à la réglementation d'Industry Canada, le présent émetteur radio peut fonctionner avec une antenne d'un type et d'un gain maximal (ou inférieur) approuvé pour l'émetteur par Industry Canada. Dans le but de réduire les risques de brouillage radio électrique à l'intention des autres utilisateurs, il faut choisir le type d'antenne et son gain de sorte que la puissance isotrope rayonnée équivalente (p.i.r.e.) ne dépasse pas l'intensité nécessaire à l'établissement d'une communication satisfaisante.

European Union (EU) CE Declaration of Conformity

This device complies with the following directives: Electromagnetic Compatibility Directive 2014/30/EU, Low-voltage Directive 2014/35/EU, Radio Equipment Directive 2014/53/EU, ErP Directive 2009/125/EC, RoHS directive (recast) 2011/65/EU & the 2015/863 Statement. This product has been tested and found to comply with all essential requirements of the Directives.

European Union (EU) RoHS (recast) Directive 2011/65/EU & the European Commission Delegated Directive (EU) 2015/863 Statement

GIGABYTE products have not intended to add and safe from hazardous substances (Cd, Pb, Hg, Cr+6, PBDE, PBB, DEHP, BBP, DBP and DIBP). The parts and components have been carefully selected to meet RoHS requirement. Moreover, we at GIGABYTE are continuing our efforts to develop products that do not use internationally banned toxic chemicals.

European Union (EU) Community Waste Electrical & Electronic Equipment (WEEE) Directive Statement

GIGABYTE will fulfill the national laws as interpreted from the 2012/19/EU WEEE (Waste Electrical and Electronic Equipment) (recast) directive. The WEEE Directive specifies the treatment, collection, recycling and disposal of electric and electronic devices and their components. Under the Directive, used equipment must be marked, collected separately, and disposed of properly.

WEEE Symbol Statement



The symbol shown below is on the product or on its packaging, which indicates that this product must not be disposed of with other waste. Instead, the device should be taken to the waste collection centers for activation of the treatment, collection, recycling and disposal procedure.

For more information about where you can drop off your waste equipment for recycling, please contact your local government office, your household waste disposal service or where you purchased the product for details of environmentally safe recycling.

Battery Information

European Union—Disposal and recycling information
GIGABYTE Recycling Program (available in some regions)



This symbol indicates that this product and/or battery should not be disposed of with household waste. You must use the public collection system to return, recycle, or treat them in compliance with the local regulations.

End of Life Directives-Recycling



The symbol shown below is on the product or on its packaging, which indicates that this product must not be disposed of with other waste. Instead, the device should be taken to the waste collection centers for activation of the treatment, collection, recycling and disposal procedure.

Déclaration de Conformité aux Directives de l'Union européenne (UE)

Cet appareil portant la marque CE est conforme aux directives de l'UE suivantes: directive Compatibilité Electromagnétique 2014/30/UE, directive Basse Tension 2014/35/UE, directive équipements radioélectriques 2014/53/UE, la directive RoHS II 2011/65/UE & la déclaration 2015/863. La conformité à ces directives est évaluée sur la base des normes européennes harmonisées applicables.

European Union (EU) CE-Konformitätserklärung

Dieses Produkte mit CE-Kennzeichnung erfüllen folgenden EU-Richtlinien: EMV-Richtlinie 2014/30/EU, Niederspannungsrichtlinie 2014/35/EU, Funkanlagen Richtlinie 2014/53/EU, RoHS-Richtlinie 2011/65/EU erfüllt und die 2015/863 Erklärung.

Die Konformität mit diesen Richtlinien wird unter Verwendung der entsprechenden Standards zur Europäischen Normierung beurteilt.

CE declaração de conformidade

Este produto com a marcação CE estão em conformidade com das seguintes Diretivas UE: Diretiva Baixa Tensão 2014/35/EU; Diretiva CEM 2014/30/EU; Diretiva RSP 2011/65/UE e a declaração 2015/863.

A conformidade com estas diretivas é verificada utilizando as normas europeias harmonizadas.

CE Declaración de conformidad

Este producto que llevan la marca CE cumplen con las siguientes Directivas de la Unión Europea: Directiva EMC 2014/30/UE, Directiva de bajo voltaje 2014/35/UE, Directiva de equipamientos de radio 2014/53/UE, Directiva RoHS 2011/65/UE y la Declaración 2015/863. El cumplimiento de estas directivas se evalúa mediante las normas europeas armonizadas.

CE Dichiarazione di conformità

I prodotti con il marchio CE sono conformi con una o più delle seguenti Direttive UE, come applicabile: Direttiva EMC 2014/30/UE, Direttiva sulla bassa tensione 2014/35/UE, Direttiva di apparecchiature radio 2014/53/UE, Direttiva RoHS 2011/65/UE e Dichiarazione 2015/863. La conformità con tali direttive viene valutata utilizzando gli Standard europei armonizzati applicabili.

Deklaracja zgodności UE Unii Europejskiej

Urządzenie jest zgodne z następującymi dyrektywami: Dyrektywa kompatybilności elektromagnetycznej 2014/30/UE, Dyrektywa niskonapięciowej 2014/35/UE, Dyrektywa urządzeń radiowych 2014/53/UE, Dyrektywa RoHS 2011/65/UE i dyrektywa 2015/863.

Niniejsze urządzenie zostało poddane testom i stwierdzono jego zgodność z wymaganiami dyrektywy.

ES Prohlášení o shodě

Toto zařízení splňuje požadavky Směrnice o Elektromagnetické kompatibilitě 2014/30/EU, Směrnice o Nízkém napětí 2014/35/EU, Směrnice o rádiových zařízeních 2014/53/EU, Směrnice RoHS 2011/65/EU a 2015/863.

Tento produkt byl testován a bylo shledáno, že splňuje všechny základní požadavky směrnice.

EK megfelelési nyilatkozata

A termék megfelelnek az alábbi irányelvek és szabványok követelményeinek, azok a kiállításidőpontjában érvényes, aktuális változatában: EMC irányelv 2014/30/EU, Kisfeszültségű villamos berendezésekre vonatkozó irányelv 2014/35/EU, rádióberendezések irányelv 2014/53/EU, RoHS irányelv 2011/65/UE és 2015/863.

Δήλωση συμμόρφωσης ΕΕ

Είναι σε συμμόρφωση με τις διατάξεις των παρακάτω Οδηγιών της Ευρωπαϊκής Κοινότητας: Οδηγία 2014/30/ΕΕ σχετικά με την ηλεκτρομαγνητική συμβατότητα, Οδηγία αμηλής τάσης 2014/35/ΕΕ, Οδηγία 2014/53/ΕΕ σε ραδιοεξοπλισμό, Οδηγία RoHS 2011/65/ΕΕ και 2015/863.

Η συμμόρφωση με αυτές τις οδηγίες αξιολογήται χρησιμοποιώντας τα ισχύοντα εναρμονισμένα ευρωπαϊκά πρότυπα.



D33006
RoHS

European Community Radio Equipment Directive Compliance Statement:

This equipment complies with all the requirements and other relevant provisions of Radio Equipment Directive 2014/53/EU. This equipment is suitable for home and office use in all the European Community Member States and EFTA Member States. The low band 5.15 -5.35 GHz is for indoor use only.

	AT	BE	BG	CH	CY	CZ	DE
	DK	EE	EL	ES	FI	FR	HR
	HU	IE	IS	IT	LI	LT	LU
	LV	MT	NL	PL	PT	RO	SE
	SI	SK	TR	UK			

NCC Wireless Statements / 無線設備警告聲明：

低功率電波輻射性電機管理辦法

- 取得審驗證明之低功率射頻器材，非經核准，公司、商號或使用者均不得擅自變更頻率、加大功率或變更原設計之特性及功能。低功率射頻器材之使用不得影響飛航安全及干擾合法通信；經發現有干擾現象時，應立即停用，並改善至無干擾時方得繼續使用。前述合法通信，指依電信管理法規定作業之無線電通信。低功率射頻器材須忍受合法通信或工業、科學及醫療用電波輻射性電機設備之干擾。
- 應避免影響附近雷達系統之操作。

Korea KCC NCC Wireless Statement:

5.25GHz - 5.35 GHz 대역을 사용하는 무선 장치는 실내에서만 사용하도록 제한됩니다.

Japan Wireless Statement:









5.15 GHz 帯 ~ 5.35 GHz 帯：屋内のみの使用。

Wireless module country approvals:







To identify your Motherboard version or revision number, look for "REV: X.X" printed on the PCB on the top left corner of the Motherboard. For example, "REV:1.0" means the revision of the motherboard is 1.0.

Motherboard revision no.:	Wireless module manufacturer, model name:
X570S AERO G rev. 1.0	Intel® Corporation AX200NGW
X570S AERO G rev. 1.1	AMD Corporation RZ608, MediaTek MT7921K

Country approvals for wireless module AX200NGW:

United States FCC: FCC ID: PD9AX200NG CanadaISED: IC: 1000M-AX200NG Australia ACMA:  Belarus:  China CMIIT: CMIIT ID: 2019AJ2274 (M) Europe: 	India WPC: ETA-SD-20190501112 Japan 総務省:  R 003-190022 T D190021003 5.15~5.35GHz 屋内限定 5.15~5.35GHz indoor use only Jordan TRC: TRC/SS/2019/122 Mexico IFT: RCPINAX19-0480 Oman TRA: Applicant number: D080001 Approval number: TRA/TA-R/7494/19	Pakistan PTA: Approved by PTA: 9.9211/2019 Qatar CRA: CRA/SM/2019/R-7710 Serbia:  II011 I9 Singapore IMDA: Complies with IMDA standards DB.02941 South Korea NRRA:  R-CNTA-X200NGW 1.상호명: INTEL CORPORATION 2.모델명: MT7921K 3.인증명: 무선랜(5.15GHz~5.35GHz) 무선기기(무선랜용) 4.제품명: 무선랜(5.15GHz~5.35GHz) 무선기기(AX200NGW) 5.인증번호: 2020/12 6.제조지/제조국: Intel Corporation / China	 Ukraine:  UA.TR.028 United Kingdom: 
--	---	--	---

Country approvals for wireless module RZ608, MT7921K:

United States FCC: FCC ID: RAS-MT7921K CanadaISED: IC ID: 7542A-MT7921K Australia ACMA:  China CMIIT: CMIIT ID: 2020AP14016(M) Europe: 	Japan 総務省:  R 020 200172 T D20 0066 020 5.15~5.35GHz 屋内限定 5.15~5.35GHz indoor use only Jordan TRC: T/4/11/11/9230 Kuwait: CITRA: 4472 Pakistan PTA: Approved by PTA 9.1167/2020	Qatar: CRASM2020S-0005758 Serbia: P1620165500 Singapore IMDA: Complies with IMDA standards NS004-20 South Korea NRRA:  R-C-MD6-MT7921K 상호명: MediaTek Inc. 모델명: MT7921K 인증명: 무선랜(5.15GHz~5.35GHz) 무선기기(무선랜용) 제조지/제조국: MediaTek Inc./China	 Thailand: RT3676 Ukraine:  UA.032.C.T.0411-20 United Kingdom: 
--	---	--	--



Contact Us

GIGA-BYTE TECHNOLOGY CO., LTD.

Address: No.6, Baoqiang Rd., Xindian Dist., New Taipei City 231

TEL: +886-2-8912-4000, FAX: +886-2-8912-4005

Tech. and Non-Tech. Support (Sales/Marketing) : <https://esupport.gigabyte.com>

WEB address (English): <https://www.gigabyte.com>

WEB address (Chinese): <https://www.gigabyte.com/tw>

- **GIGABYTE eSupport**

To submit a technical or non-technical (Sales/Marketing) question, please link to:
<https://esupport.gigabyte.com>

The screenshot shows the GIGABYTE eSupport landing page. At the top left is the GIGABYTE logo. The main heading is "Welcome to eSupport" in blue. Below it is a sub-heading: "Submit your product/sponsorship/marketing questions or inquiries, and our representative will respond in a timely fashion." The page is divided into three main sections:

- NEWS:** A box with the text "Your submissions will be displayed in your personal page, log in to see the processing status."
- SIGN IN:** A login form with fields for "Account" and "Password", a "SIGN IN" button, and a "Register | Forget Password" link. It also features "sign in with" options for Facebook, Google, Twitter, and Windows.
- QUICK LINK:** A box with three icons: "Downloads" (cloud with plus), "FAQ" (speech bubbles), and "Warranty" (shield).