

X299 AORUS Ultra Gaming

User's Manual

Rev. 1001

12ME-X29ARUG-1001R



For more product details, please visit GIGABYTE's website.



To reduce the impacts on global warming, the packaging materials of this product are recyclable and reusable. GIGABYTE works with you to protect the environment.

Declaration of Conformity

We, Manufacturer/Importer,

G.B.T. Technology Trading GmbH

Address: Bullenkoppel 16, 22047 Hamburg, Germany

Declare that the product

Product Type: **Motherboard**

Product Name: **X299 AORUS Ultra Gaming**

conforms with the essential requirements of the following directives:

- EMC Directive 2014/30/EU:**
 - Conduction & Radiated Emissions: EN 55022:2010/AC2011
 - Immunity: EN 55024:2010
 - Power-line harmonics: EN 61000-3-2:2006+A2:2009
 - Power-line flicker: EN 61000-3-3:2013

- Low Voltage Directive 2014/35/EU:**
 - Safety: EN60950-1:2006+A11:2009+A12:2011+A2:2013

- RoHS Directive 2011/65/EU**
 - Restriction of use of certain substances in electronic equipment: This product does not contain any of the restricted substances listed in Annex II, in concentrations and applications banned by the directive.

CE marking



Signature: Timmy Huang

(Name) Date: Jun. 30, 2017 Name: Timmy Huang

DECLARATION OF CONFORMITY

Per FCC Part 2 Section 2.1077(a)



Responsible Party Name: G.B.T. INC. (U.S.A.)

Address: 17358 Railroad Street

City of Industry, CA 91748

Phone/Fax No: (626) 854-9338/ (626) 854-9326

hereby declares that the product

Product Name: Motherboard

Model Number: X299 AORUS Ultra Gaming

Conforms to the following specifications:

FCC Part 15, Subpart B, Section 15.107(a) and Section 15.109

(a), Class B Digital Device

Supplementary Information:

This device complies with part 15 of the FCC Rules. Operation is subject to the following two conditions: (1) This device may not cause harmful and (2) this device must accept any interference received, including that may cause undesired operation.

Representative Person's Name: ERIC LU

Signature: Eric Lu

Date: Jun. 30, 2017

Copyright

© 2017 GIGA-BYTE TECHNOLOGY CO., LTD. All rights reserved.

The trademarks mentioned in this manual are legally registered to their respective owners.

Disclaimer

Information in this manual is protected by copyright laws and is the property of GIGABYTE. Changes to the specifications and features in this manual may be made by GIGABYTE without prior notice.

No part of this manual may be reproduced, copied, translated, transmitted, or published in any form or by any means without GIGABYTE's prior written permission.

Documentation Classifications

In order to assist in the use of this product, GIGABYTE provides the following types of documentations:

- For quick set-up of the product, read the Quick Installation Guide included with the product.
- For detailed product information, carefully read the User's Manual.

For product-related information, check on our website at: <http://www.gigabyte.com>

Identifying Your Motherboard Revision

The revision number on your motherboard looks like this: "REV: X.X." For example, "REV: 1.0" means the revision of the motherboard is 1.0. Check your motherboard revision before updating motherboard BIOS, drivers, or when looking for technical information.

Example:

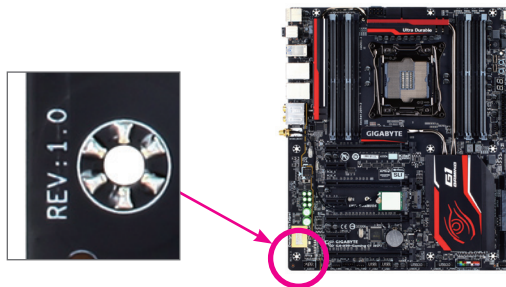

Table of Contents

Box Contents	6
Optional Items	6
X299 AORUS Ultra Gaming Motherboard Layout	7
Chapter 1 Hardware Installation	9
1-1 Installation Precautions	9
1-2 Product Specifications	10
1-3 Installing the CPU and CPU Cooler.....	14
1-3-1 Installing the CPU	14
1-3-2 Installing the CPU Cooler	16
1-4 Installing the Memory	17
1-4-1 4 Channel Memory Configuration.....	17
1-4-2 Installing a Memory.....	19
1-5 Installing an Expansion Card.....	20
1-6 Setting up AMD CrossFire™/NVIDIA® SLI™ Configuration.....	21
1-7 Back Panel Connectors	23
1-8 Onboard LEDs and Buttons.....	25
1-9 Internal Connectors	26
Chapter 2 BIOS Setup	41
2-1 Startup Screen.....	42
2-2 The Main Menu.....	43
2-3 M.I.T.	45
2-4 System	58
2-5 BIOS	59
2-6 Peripherals.....	62
2-7 Chipset.....	65
2-8 Power	66
2-9 Save & Exit	68
Chapter 3 Configuring a RAID Set	69
3-1 Configuring SATA Controllers.....	69
3-2 Installing the RAID/AHCI Driver and Operating System	83
3-3 Installing an Intel® Optane™ Memory.....	86
Chapter 4 Drivers Installation	89
4-1 Drivers & Software.....	89
4-2 Application Software.....	90
4-3 Information.....	90

Chapter 5 Unique Features.....	91
5-1 BIOS Update Utilities.....	91
5-1-1 Updating the BIOS with the Q-Flash Utility.....	91
5-1-2 Updating the BIOS with the @BIOS Utility.....	94
5-2 APP Center.....	95
5-2-1 3D OSD.....	96
5-2-2 AutoGreen.....	97
5-2-3 BIOS Setup.....	98
5-2-4 Color Temperature.....	99
5-2-5 Cloud Station.....	100
5-2-6 EasyTune.....	105
5-2-7 Easy RAID.....	106
5-2-8 Fast Boot.....	108
5-2-9 Game Boost.....	109
5-2-10 Platform Power Management.....	110
5-2-11 RGB Fusion.....	111
5-2-12 Smart TimeLock.....	113
5-2-13 Smart Keyboard.....	114
5-2-14 Smart Backup.....	115
5-2-15 Smart HUD.....	117
5-2-16 System Information Viewer.....	118
5-2-17 USB Blocker.....	119
5-2-18 V-Tuner.....	120
Chapter 6 Appendix.....	121
6-1 Configuring Audio Input and Output.....	121
6-1-1 Configuring 2/4/5.1/7.1-Channel Audio.....	121
6-1-2 Configuring S/PDIF Out.....	123
6-1-3 Configuring Microphone Recording.....	124
6-1-4 Using the Voice Recorder.....	126
6-1-5 Sound BlasterX 720°.....	127
6-2 Troubleshooting.....	129
6-2-1 Frequently Asked Questions.....	129
6-2-2 Troubleshooting Procedure.....	130
Regulatory Statements.....	132
Contact Us.....	135

Box Contents

- X299 AORUS Ultra Gaming motherboard
- Motherboard driver disk
- User's Manual
- Quick Installation Guide
- Four SATA cables
- I/O Shield
- One GC-SLI2P bridge connector
- One G Connector
- One RGB (RGBW) LED strip extension cable
- Two thermistor cables
- One M.2 screw kit

The box contents above are for reference only and the actual items shall depend on the product package you obtain. The box contents are subject to change without notice.

Optional Items

- 2-port USB 2.0 bracket (Part No. 12CR1-1UB030-6*R)
- eSATA bracket (Part No. 12CF1-3SATPW-4*R)
- 3.5" Front Panel with 2 USB 3.1 Gen 1 ports (Part No. 12CR1-FPX582-2*R)

X299 AORUS Ultra Gaming Motherboard Layout

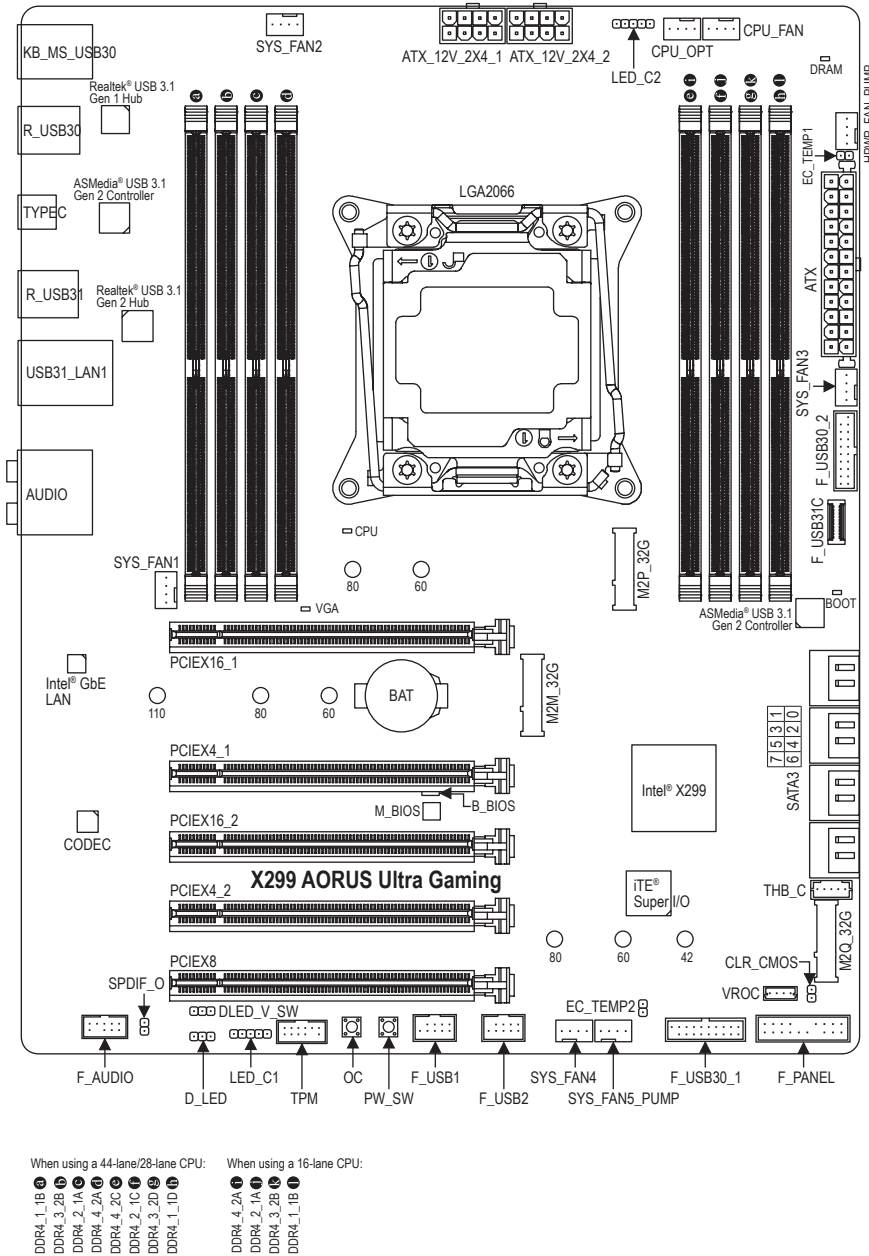







Chapter 1 Hardware Installation

1-1 Installation Precautions

The motherboard contains numerous delicate electronic circuits and components which can become damaged as a result of electrostatic discharge (ESD). Prior to installation, carefully read the user's manual and follow these procedures:



- Prior to installation, make sure the chassis is suitable for the motherboard.
- Prior to installation, do not remove or break motherboard S/N (Serial Number) sticker or warranty sticker provided by your dealer. These stickers are required for warranty validation.
- Always remove the AC power by unplugging the power cord from the power outlet before installing or removing the motherboard or other hardware components.
- When connecting hardware components to the internal connectors on the motherboard, make sure they are connected tightly and securely.
- When handling the motherboard, avoid touching any metal leads or connectors.
- It is best to wear an electrostatic discharge (ESD) wrist strap when handling electronic components such as a motherboard, CPU or memory. If you do not have an ESD wrist strap, keep your hands dry and first touch a metal object to eliminate static electricity.
- Prior to installing the motherboard, please have it on top of an antistatic pad or within an electrostatic shielding container.
- Before connecting or unplugging the power supply cable from the motherboard, make sure the power supply has been turned off.
- Before turning on the power, make sure the power supply voltage has been set according to the local voltage standard.
- Before using the product, please verify that all cables and power connectors of your hardware components are connected.
- To prevent damage to the motherboard, do not allow screws to come in contact with the motherboard circuit or its components.
- Make sure there are no leftover screws or metal components placed on the motherboard or within the computer casing.
- Do not place the computer system on an uneven surface.
- Do not place the computer system in a high-temperature or wet environment.
- Turning on the computer power during the installation process can lead to damage to system components as well as physical harm to the user.
- If you are uncertain about any installation steps or have a problem related to the use of the product, please consult a certified computer technician.
- If you use an adapter, extension power cable, or power strip, ensure to consult with its installation and/or grounding instructions.





1-2 Product Specifications



 CPU	<ul style="list-style-type: none"> Support for Intel® Core™ X series processors in the LGA2066 package (Go to GIGABYTE's website for the latest CPU support list.) L3 cache varies with CPU
 Chipset	<ul style="list-style-type: none"> Intel® X299 Express Chipset
 Memory	<ul style="list-style-type: none"> 8 x DDR4 DIMM sockets supporting up to 128 GB of system memory ^(Note 1) 4 x DDR4 DIMM sockets supporting up to 64 GB of system memory ^(Note 2) 4 channel memory architecture ^(Note 1) Dual channel memory architecture ^(Note 2) Support for DDR4 2667/2400/2133 MHz memory modules Support for non-ECC Un-buffered DIMM 1Rx8/2Rx8/1Rx16 memory modules Support for Extreme Memory Profile (XMP) memory modules (Go to GIGABYTE's website for the latest supported memory speeds and memory modules.)
 Audio	<ul style="list-style-type: none"> Realtek® ALC1220 codec Support for Sound BlasterX 720° High Definition Audio 2/4/5.1/7.1-channel Support for S/PDIF Out
 LAN	<ul style="list-style-type: none"> Intel® GbE LAN chip (10/100/1000 Mbit)
 Expansion Slots	<ul style="list-style-type: none"> 2 x PCI Express x16 slots, running at x16 (PCIEX16_1, PCIEX16_2) 1 x PCI Express x16 slot, running at x8 (PCIEX8) 2 x PCI Express x16 slots, running at x4 (PCIEX4_1, PCIEX4_2) (All of the PCI Express x16 slots conform to PCI Express 3.0 standard.) <p>* The PCIEX4_1 slot shares bandwidth with the M2M_32G connector. The PCIEX4_1 slot becomes unavailable when a device is installed in the M2M_32G connector.</p> <p>* Refer to "1-6 Setting up AMD CrossFire™/NVIDIA® SLI™ Configuration," for the installation notices for the PCI Express x16 slots.</p>
 Multi-Graphics Technology	<ul style="list-style-type: none"> Support for NVIDIA® Quad-GPU SLI™ and 3-Way/2-Way NVIDIA® SLI™ technologies ^(Note 1) Support for AMD Quad-GPU CrossFire™ and 3-Way ^(Note 1)/2-Way AMD CrossFire™ technologies

(Note 1) Supported when using a 44-lane or 28-lane CPU.

(Note 2) Supported when using a 16-lane CPU.

	Storage Interface ♦	<ul style="list-style-type: none"> ♦ Chipset: <ul style="list-style-type: none"> - 1 x M.2 connector (Socket 3, M key, type 2260/2280 SATA and PCIe x4/x2 SSD support) (M2P_32G) - 1 x M.2 connector (Socket 3, M key, type 2260/2280/22110 PCIe x4/x2 SSD support)(M2M_32G) - 1 x M.2 connector (Socket 3, M key, type 2242/2260/2280 SATA and PCIe x4/x2 SSD support) (M2Q_32G) - 8 x SATA 6Gb/s connectors - Support for RAID 0, RAID 1, RAID 5, and RAID 10 * The M2M_32G connector must work with an Intel® VROC Upgrade Key to support RAID configuration. * Refer to "1-9 Internal Connectors," for the installation notices for the M.2 and SATA connectors.
	USB	<ul style="list-style-type: none"> ♦ Chipset+2 ASMedia® USB 3.1 Gen 2 Controllers: <ul style="list-style-type: none"> - 1 x USB 3.1 Gen 2 port available through the internal USB header - 1 x USB Type-C™ port on the back panel, with USB 3.1 Gen 2 support ♦ Chipset+Realtek® USB 3.1 Gen 2 Hub: <ul style="list-style-type: none"> - 4 x USB 3.1 Gen 2 Type-A ports (red) on the back panel ♦ Chipset+Realtek® USB 3.1 Gen 1 Hub: <ul style="list-style-type: none"> - 4 x USB 3.1 Gen 1 ports on the back panel ♦ Chipset: <ul style="list-style-type: none"> - 4 x USB 3.1 Gen 1 ports available through the internal USB headers - 4 x USB 2.0/1.1 ports available through the internal USB headers
	Internal Connectors	<ul style="list-style-type: none"> ♦ 1 x 24-pin ATX main power connector ♦ 2 x 8-pin ATX 12V power connectors ♦ 1 x CPU fan header ♦ 1 x water cooling CPU fan header ♦ 4 x system fan headers ♦ 1 x system fan/water cooling pump header ♦ 1 x 3 Amp fan/water cooling pump header ♦ 1 x digital LED strip header ♦ 1 x digital LED strip power select jumper ♦ 2 x RGB (RGBW) LED strip extension cable headers ♦ 3 x M.2 Socket 3 connectors ♦ 8 x SATA 6Gb/s connectors ♦ 1 x Intel® VROC Upgrade Key header ♦ 1 x front panel header ♦ 1 x front panel audio header ♦ 1 x S/PDIF Out header ♦ 1 x USB 3.1 Gen 2 header ♦ 2 x USB 3.1 Gen 1 headers ♦ 2 x USB 2.0/1.1 headers ♦ 1 x Thunderbolt™ add-in card connector ♦ 1 x Trusted Platform Module (TPM) header ♦ 1 x power button ♦ 1 x OC button ♦ 2 x temperature sensor headers ♦ 1 x Clear CMOS jumper

	Back Panel Connectors	<ul style="list-style-type: none"> ◆ 1 x PS/2 keyboard/mouse port ◆ 1 x USB Type-C™ port, with USB 3.1 Gen 2 support ◆ 4 x USB 3.1 Gen 2 Type-A ports (red) ◆ 4 x USB 3.1 Gen 1 ports ◆ 1 x RJ-45 port ◆ 6 x audio jacks (Center/Subwoofer Speaker Out, Rear Speaker Out, Side Speaker Out, Line In, Line Out, Mic In)
	I/O Controller	<ul style="list-style-type: none"> ◆ iTE® I/O Controller Chip
	Hardware Monitor	<ul style="list-style-type: none"> ◆ Voltage detection ◆ Temperature detection ◆ Fan speed detection ◆ Water cooling flow rate detection ◆ Overheating warning ◆ Fan fail warning ◆ Fan speed control <p style="margin-left: 40px;">* Whether the fan (pump) speed control function is supported will depend on the fan (pump) you install.</p>
	BIOS	<ul style="list-style-type: none"> ◆ 2 x 128 Mbit flash ◆ Use of licensed AMI UEFI BIOS ◆ Support for DualBIOS™ ◆ PnP 1.0a, DMI 2.7, WfM 2.0, SM BIOS 2.7, ACPI 5.0
	Unique Features	<ul style="list-style-type: none"> ◆ Support for APP Center <ul style="list-style-type: none"> * Available applications in APP Center may vary by motherboard model. Supported functions of each application may also vary depending on motherboard specifications. - 3D OSD - @BIOS - AutoGreen - BIOS Setup - Color Temperature - Cloud Station - EasyTune - Easy RAID - Fast Boot - Game Boost - ON/OFF Charge - Platform Power Management - RGB Fusion - Smart Backup - Smart Keyboard - Smart TimeLock - Smart HUD - System Information Viewer - USB Blocker - V-Tuner ◆ Support for Q-Flash ◆ Support for Xpress Install

	Bundled Software	<ul style="list-style-type: none"> ◆ Norton® Internet Security (OEM version) ◆ Intel® Optane™ Memory Ready ◆ cFosSpeed
	Operating System	<ul style="list-style-type: none"> ◆ Support for Windows 10 64-bit
	Form Factor	<ul style="list-style-type: none"> ◆ ATX Form Factor; 30.5cm x 24.4cm

* GIGABYTE reserves the right to make any changes to the product specifications and product-related information without prior notice.



Please visit GIGABYTE's website for support lists of CPU, memory modules, SSDs, and M.2 devices.



Please visit the **Support Utility List** page on GIGABYTE's website to download the latest version of apps.

1-3 Installing the CPU and CPU Cooler



Read the following guidelines before you begin to install the CPU:

- Make sure that the motherboard supports the CPU.
(Go to GIGABYTE's website for the latest CPU support list.)
- Always turn off the computer and unplug the power cord from the power outlet before installing the CPU to prevent hardware damage.
- Locate the pin one of the CPU. The CPU cannot be inserted if oriented incorrectly. (Or you may locate the notches on both sides of the CPU and alignment keys on the CPU socket.)
- Apply an even and thin layer of thermal grease on the surface of the CPU.
- Do not turn on the computer if the CPU cooler is not installed, otherwise overheating and damage of the CPU may occur.
- Set the CPU host frequency in accordance with the CPU specifications. It is not recommended that the system bus frequency be set beyond hardware specifications since it does not meet the standard requirements for the peripherals. If you wish to set the frequency beyond the standard specifications, please do so according to your hardware specifications including the CPU, graphics card, memory, hard drive, etc.

1-3-1 Installing the CPU

- A. Locate the alignment keys on the motherboard CPU socket and the notches on the CPU.

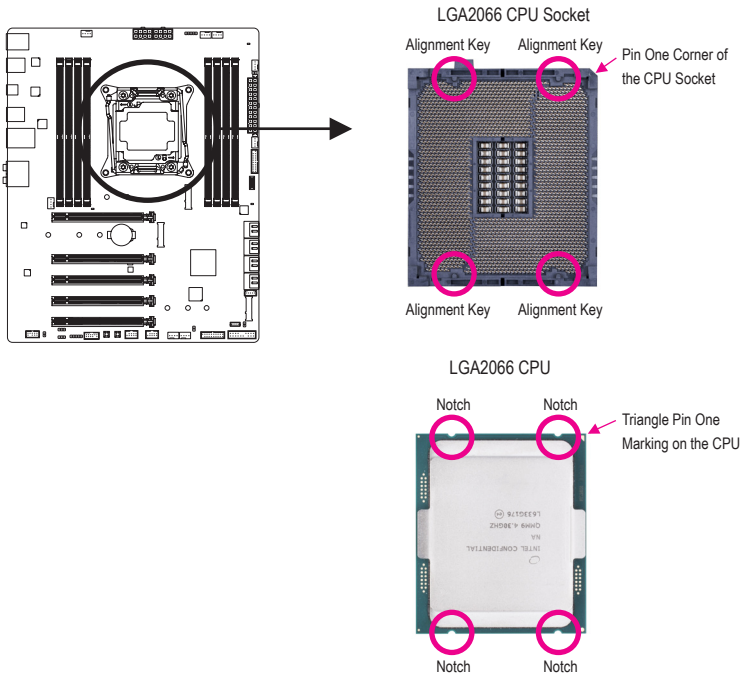

B. Follow the steps below to correctly install the CPU into the motherboard CPU socket.



- Before installing the CPU, make sure to turn off the computer and unplug the power cord from the power outlet to prevent damage to the CPU.
- To protect the socket contacts, do not remove the protective plastic cover unless the CPU is inserted into the CPU socket. Save the cover properly and replace it if the CPU is removed.

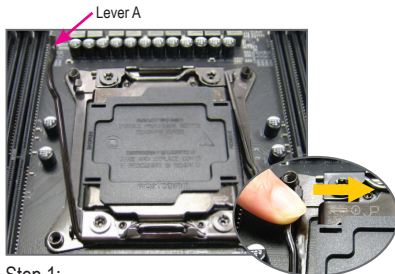

Step 1:
Push the lever closest to the "unlock" mark "☐" (below referred as lever A) down and away from the socket to release it.

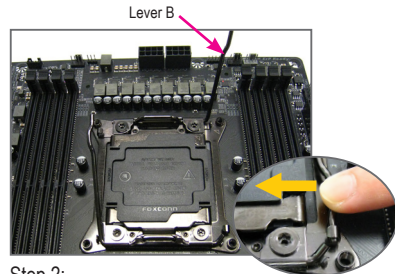

Step 2:
Push the lever closest to the "lock" mark "☐" (below referred as lever B) down and away from the socket. Then lift the lever.



Step 3:
Gently press lever A to allow the load plate to rise. Open the load plate. Note: DO NOT touch the socket contacts after the load plate is opened.

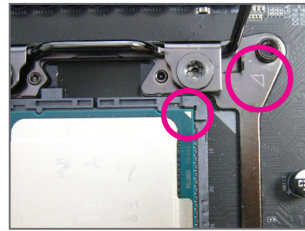

Step 4:
Hold the CPU with your thumb and index fingers. Align the CPU pin one mark (triangle) with the triangle mark on metal socket frame and carefully insert the CPU into the socket vertically.



Step 5:
Once the CPU is properly inserted, carefully replace the load plate. Then secure lever B under its retention tab.



Step 6:
Finally, secure lever A under its retention tab to complete the installation of the CPU. Then carefully remove the plastic cover. Save it properly and always replace it when the CPU is not installed.

1-3-2 Installing the CPU Cooler

Refer to the steps below to correctly install the CPU cooler on the motherboard. (Actual installation process may differ depending on the CPU cooler to be used. Refer to the user's manual for your CPU cooler.)

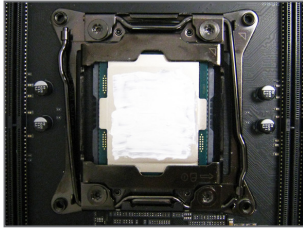

Step 1:
Apply an even and thin layer of thermal grease on the surface of the installed CPU.

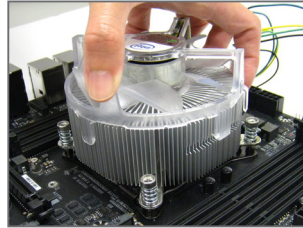

Step 2:
Place the cooler atop the CPU, aligning the four mounting screws with the mounting holes on the ILM.

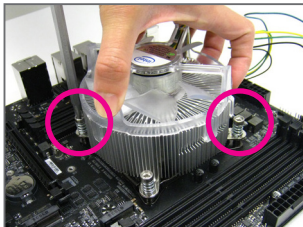

Step 3:
Use one hand to hold the cooler and the other to tighten the screws in a diagonal sequence with a screw driver. Begin tightening a screw with a few turns and repeat with the screw diagonally opposite the one you just tightened. Then do the same to the other pair. Next, fully tighten the four screws.

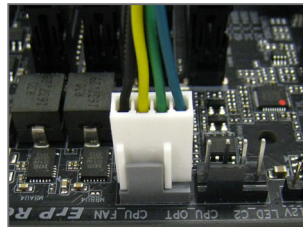

Step 4:
Finally, attach the power connector of the CPU cooler to the CPU fan header (CPU_FAN) on the motherboard.



Use extreme care when removing the CPU cooler because the thermal grease/tape between the CPU cooler and CPU may adhere to the CPU. Inadequately removing the CPU cooler may damage the CPU.

1-4 Installing the Memory



Read the following guidelines before you begin to install the memory:

- Make sure that the motherboard supports the memory. It is recommended that memory of the same capacity, brand, speed, and chips be used.
(Go to GIGABYTE's website for the latest supported memory speeds and memory modules.)
- Always turn off the computer and unplug the power cord from the power outlet before installing the memory to prevent hardware damage.
- Memory modules have a foolproof design. A memory module can be installed in only one direction. If you are unable to insert the memory, switch the direction.

1-4-1 4 Channel Memory Configuration

- When using a 44-lane/28-lane CPU:

This motherboard supports 4 Channel Technology. After the memory is installed, the BIOS will automatically detect the specifications and capacity of the memory. The eight DDR4 memory sockets are divided into four channels and each channel has two memory sockets as following:

- ▶▶ Channel A: DDR4_2_1A, DDR4_4_2A
- ▶▶ Channel B: DDR4_1_1B, DDR4_3_2B
- ▶▶ Channel C: DDR4_2_1C, DDR4_4_2C
- ▶▶ Channel D: DDR4_1_1D, DDR4_3_2D

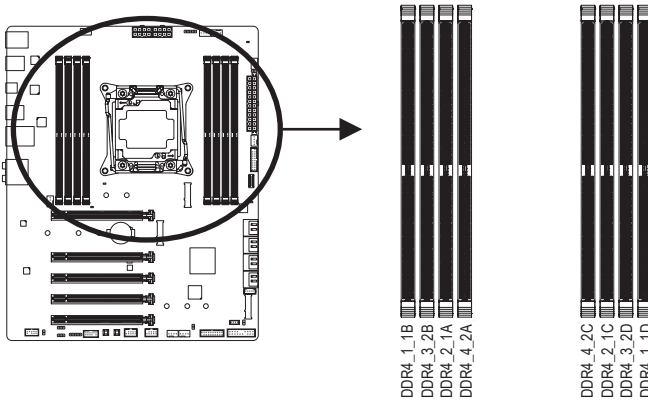

▶▶ Refer to the table below for memory installation according to the number of the memory modules you want to install:

	DDR4_1_1B	DDR4_3_2B	DDR4_2_1A	DDR4_4_2A	DDR4_4_2C	DDR4_2_1C	DDR4_3_2D	DDR4_1_1D
2 Modules	✗	✗	✗	✗	✗	✗	✗	✓
4 Modules	✓	✗	✓	✗	✗	✓	✗	✓
6 Modules	✓	✗	✓	✗	✓	✓	✓	✓
8 Modules	✓	✓	✓	✓	✓	✓	✓	✓

✓ : Installed, ✗ : Not Installed.

Note: When installing the memory, make sure to begin with the first socket of each channel, such as DDR4_2_1A, DDR4_1_1B, DDR4_2_1C, or DDR4_1_1D.

- When using a 16-lane CPU:

This motherboard supports Dual Channel Technology. After the memory is installed, the BIOS will automatically detect the specifications and capacity of the memory. The four DDR4 memory sockets are divided into two channels and each channel has two memory sockets as following:

▶▶ Channel A: DDR4_2_1A, DDR4_4_2A

▶▶ Channel B: DDR4_1_1B, DDR4_3_2B

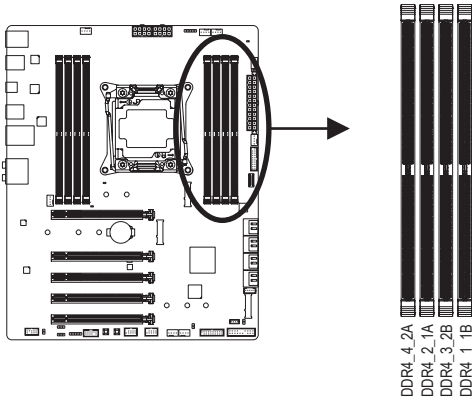

▶▶ Dual Channel Memory Configurations Table

	DDR4_4_2A	DDR4_2_1A	DDR4_3_2B	DDR4_1_1B
2 Modules	✗	✓	✗	✓
4 Modules	✓	✓	✓	✓

✓ : Installed, ✗ : Not Installed.

Due to CPU limitations, read the following guidelines before installing the memory in Dual Channel mode.

1. Dual Channel mode cannot be enabled if only one memory module is installed.
2. When enabling Dual Channel mode with two or four memory modules, it is recommended that memory of the same capacity, brand, speed, and chips be used.

1-4-2 Installing a Memory

 Before installing a memory module, make sure to turn off the computer and unplug the power cord from the power outlet to prevent damage to the memory module. DDR4 and DDR3 DIMMs are not compatible to each other or DDR2 DIMMs. Be sure to install DDR4 DIMMs on this motherboard.

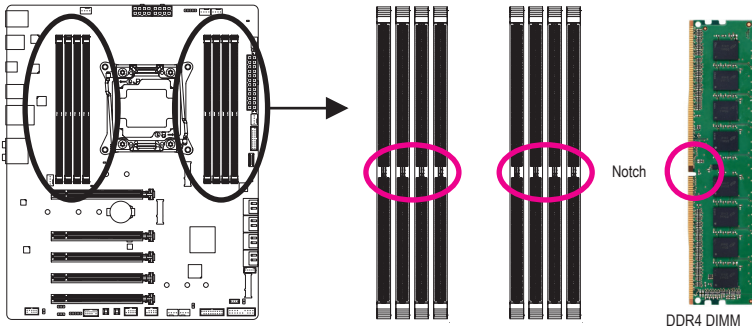

A DDR4 memory module has a notch, so it can only fit in one direction. Follow the steps below to correctly install your memory modules in the memory sockets.

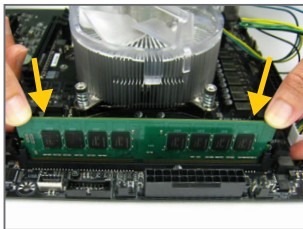

Step 1:

Note the orientation of the memory module. Spread the retaining clip at the right end of the memory socket. Place the memory module on the socket. As indicated in the picture on the left, place your fingers on the top edge of the memory, push down on the memory and insert it vertically into the memory socket.

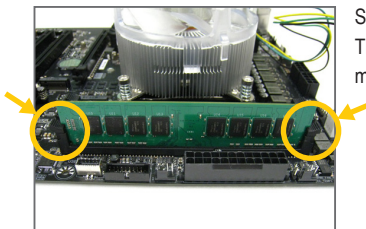

Step 2:

The clip at the right end of the socket will snap into place when the memory module is securely inserted.

1-5 Installing an Expansion Card



Read the following guidelines before you begin to install an expansion card:

- Make sure the motherboard supports the expansion card. Carefully read the manual that came with your expansion card.
- Always turn off the computer and unplug the power cord from the power outlet before installing an expansion card to prevent hardware damage.

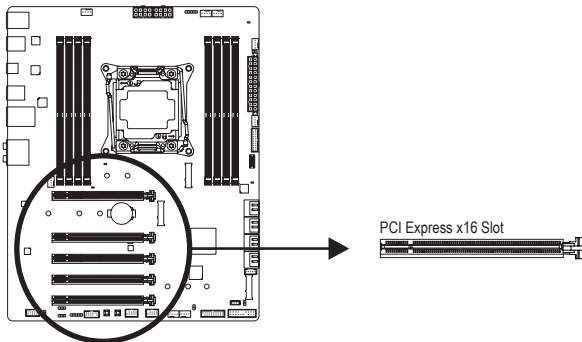

Follow the steps below to correctly install your expansion card in the expansion slot.

1. Locate an expansion slot that supports your card. Remove the metal slot cover from the chassis back panel.
2. Align the card with the slot, and press down on the card until it is fully seated in the slot.
3. Make sure the metal contacts on the card are completely inserted into the slot.
4. Secure the card's metal bracket to the chassis back panel with a screw.
5. After installing all expansion cards, replace the chassis cover(s).
6. Turn on your computer. If necessary, go to BIOS Setup to make any required BIOS changes for your expansion card(s).
7. Install the driver provided with the expansion card in your operating system.

Example: Installing and Removing a PCI Express Graphics Card:



- Installing a Graphics Card:
Gently push down on the top edge of the card until it is fully inserted into the PCI Express slot. Make sure the card is securely seated in the slot and does not rock.



- Removing the Card:
Gently push back on the lever on the slot and then lift the card straight out from the slot.

1-6 Setting up AMD CrossFire™/NVIDIA® SLI™ Configuration

A. System Requirements

- Windows 10 64-bit operating system
- A CrossFire/SLI-supported motherboard with two or more PCI Express x16 slots and correct driver
- CrossFire/SLI-ready graphics cards of identical brand and chip and correct driver
(For the latest GPUs that support the 3-way CrossFire/SLI technology, please refer to the AMD/NVIDIA® website.) ^(Note 1)
- CrossFire ^(Note 2)/SLI bridge connectors
- A power supply with sufficient power is recommended (Refer to the manual of your graphics cards for the power requirement)

B. Connecting the Graphics Cards

Step 1:

Observe the steps in "1-5 Installing an Expansion Card" and install CrossFire/SLI graphics cards on the PCI Express x16 slots.

Step 2:

Insert the CrossFire ^(Note 2)/SLI bridge connectors in the CrossFire/SLI gold edge connectors on top of the cards.

Step 3:

Plug the display cable into the graphics card on the PCIEX16_1 slot.

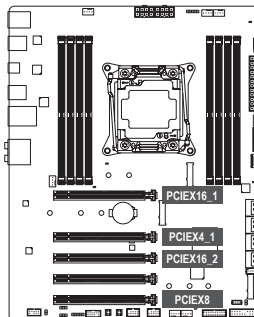

▶▶ Refer to the table below when using a 44-lane CPU:

	1-Way	2-Way	3-Way
PCIEX16_1	✓ (x16)	✓ (x16)	✓ (x16)
PCIEX16_2	✗	✓ (x16)	✓ (x16)
PCIEX8	✗	✗	✓ (x8)

✓ : Installed, ✗ : Not Installed.

▶▶ Refer to the table below when using a 28-lane CPU:

	1-Way	2-Way	3-Way
PCIEX16_1	✓ (x16)	✓ (x16)	✓ (x8)
PCIEX16_2	✗	✓ (x8)	✓ (x8)
PCIEX8	✗	✗	✓ (x8)

✓ : Installed, ✗ : Not Installed.

▶▶ Refer to the table below when using a 16-lane CPU:

	1-Way	2-Way ^(Note 3)
PCIEX16_1	✓ (x8)	✓ (x8)
PCIEX4_1	✗	✗
PCIEX16_2	✗	✓ (x4)
PCIEX8	✗	✗

✓ : Installed, ✗ : Not Installed.

(Note 1) When using dual core graphics cards, only 2-way is supported.

(Note 2) The bridge connector(s) may be needed or not depending on your graphics cards.

(Note 3) Supports the CrossFire technology only.



Procedure and driver screen for enabling CrossFire/SLI technology may differ by graphics cards and driver version. Refer to the manual that came with your graphics cards for more information about enabling CrossFire/SLI technology.

1-7 Back Panel Connectors

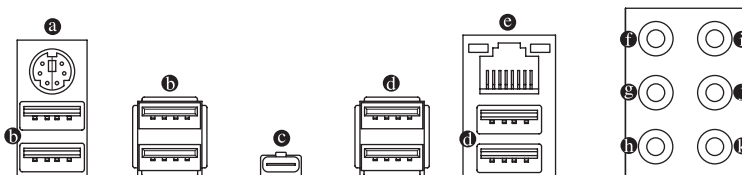

a PS/2 Keyboard/Mouse Port

Use this port to connect a PS/2 mouse or keyboard.

b USB 3.1 Gen 1 Port

The USB 3.0 port supports the USB 3.0 specification and is compatible to the USB 2.0/1.1 specification. Use this port for USB devices.

c USB Type-C™ Port

The reversible USB port supports the USB 3.1 Gen 2 specification and is compatible to the USB 3.1 Gen 1 and USB 2.0 specification. Use this port for USB devices.

d USB 3.1 Gen 2 Type-A Port (Red)

The USB 3.1 Gen 2 Type-A port supports the USB 3.1 Gen 2 specification and is compatible to the USB 3.1 Gen 1 and USB 2.0 specification. Use this port for USB devices.

e RJ-45 LAN Port

The Gigabit Ethernet LAN port provides Internet connection at up to 1 Gbps data rate. The following describes the states of the LAN port LEDs.

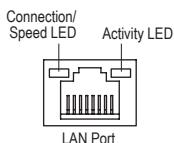

Connection/Speed LED:

State	Description
Orange	1 Gbps data rate
Green	100 Mbps data rate
Off	10 Mbps data rate

Activity LED:

State	Description
Blinking	Data transmission or receiving is occurring
Off	No data transmission or receiving is occurring

f Center/Subwoofer Speaker Out (Orange)

Use this audio jack to connect center/subwoofer speakers in a 5.1/7.1-channel audio configuration.

g Rear Speaker Out (Black)

This jack can be used to connect rear speakers in a 4/5.1/7.1-channel audio configuration.

h Side Speaker Out (Gray)

Use this audio jack to connect side speakers in a 7.1-channel audio configuration.



- When removing the cable connected to a back panel connector, first remove the cable from your device and then remove it from the motherboard.
- When removing the cable, pull it straight out from the connector. Do not rock it side to side to prevent an electrical short inside the cable connector.

❶ **Line In (Blue)**

The line in jack. Use this audio jack for line in devices such as an optical drive, walkman, etc.

❷ **Line Out (Green)**

The line out jack. Use this audio jack for a headphone or 2-channel speaker. This jack can be used to connect front speakers in a 4/5.1/7.1-channel audio configuration.

❸ **Mic In (Pink)**

The Mic in jack.



Refer to the instructions on setting up a 2/4/5.1/7.1-channel audio configuration in Chapter 6, "Configuring 2/4/5.1/7.1-Channel Audio."

1-8 Onboard LEDs and Buttons

Status LEDs

The status LEDs show whether the CPU, graphics card, memory, and operating system are working properly after system power-on. If the CPU/VGA/DRAM LED is on, that means the corresponding device is not working normally; if the BOOT LED is on, that means you haven't entered the operating system yet.

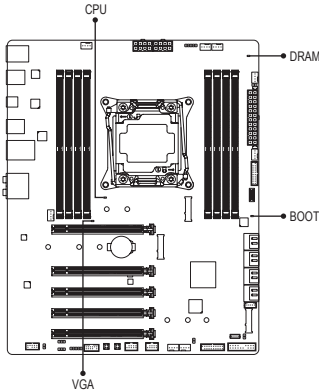

- CPU:** CPU status LED
- VGA:** Graphics card status LED
- DRAM:** Memory status LED
- BOOT:** Operating system status LED

Power Button (PW_SW) and OC Button (OC)

The power button allows users to quickly turn on/off the computer in an open-case environment when they want to change hardware components or conduct hardware testing. The OC button helps enthusiasts and overclockers not only get the most performance from their hardware, but also the absolute most enjoyable OC experience.

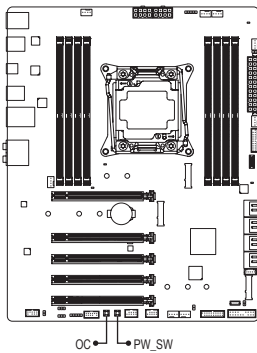

- PW_SW:** Power Button
- OC Button:**
Press this button to load the most optimized GIGABYTE
overclocking configuration for your hardware.

1-9 Internal Connectors

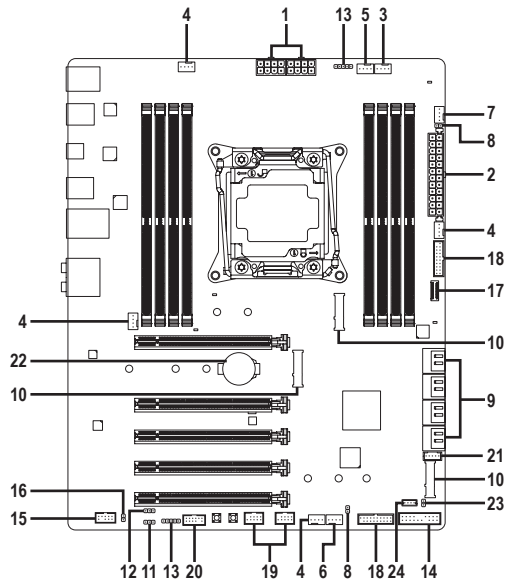

1) ATX_12V_2X4_1/ATX_12V_2X4_2	13) LED_C1/LED_C2
2) ATX	14) F_PANEL
3) CPU_FAN	15) F_AUDIO
4) SYS_FAN1/2/3/4	16) SPDIF_O
5) CPU_OPT	17) F_USB31C
6) SYS_FAN5_PUMP	18) F_USB30_1/F_USB30_2
7) HPWR_FAN_PUMP	19) F_USB1/F_USB2
8) EC_TEMP1/EC_TEMP2	20) TPM
9) SATA3 0/1/2/3/4/5/6/7	21) THB_C
10) M2P_32G/M2M_32G/M2Q_32G	22) BAT
11) D_LED	23) CLR_CMOS
12) DLED_V_SW	24) VROC



Read the following guidelines before connecting external devices:

- First make sure your devices are compliant with the connectors you wish to connect.
- Before installing the devices, be sure to turn off the devices and your computer. Unplug the power cord from the power outlet to prevent damage to the devices.
- After installing the device and before turning on the computer, make sure the device cable has been securely attached to the connector on the motherboard.

1/2) ATX_12V_2X4_1/ATX_12V_2X4_2/ATX (2x4 12V Power Connector and 2x12 Main Power Connector)

With the use of the power connector, the power supply can supply enough stable power to all the components on the motherboard. Before connecting the power connector, first make sure the power supply is turned off and all devices are properly installed. The power connector possesses a foolproof design. Connect the power supply cable to the power connector in the correct orientation.

The 12V power connector mainly supplies power to the CPU. If the 12V power connector is not connected, the computer will not start.



To meet expansion requirements, it is recommended that a power supply that can withstand high power consumption be used (500W or greater). If a power supply is used that does not provide the required power, the result can lead to an unstable or unbootable system.

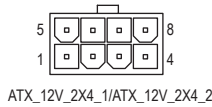
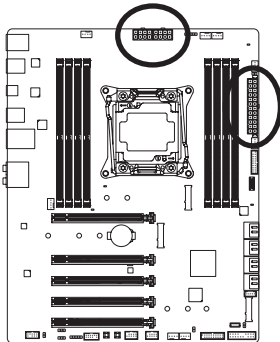

ATX_12V_2X4_1/ATX_12V_2X4_2:

Pin No.	Definition
1	GND (Only for 2x4-pin 12V)
2	GND (Only for 2x4-pin 12V)
3	GND
4	GND
5	+12V (Only for 2x4-pin 12V)
6	+12V (Only for 2x4-pin 12V)
7	+12V
8	+12V

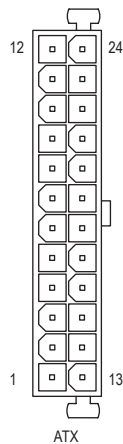

ATX:

Pin No.	Definition	Pin No.	Definition
1	3.3V	13	3.3V
2	3.3V	14	-12V
3	GND	15	GND
4	+5V	16	PS_ON (soft On/Off)
5	GND	17	GND
6	+5V	18	GND
7	GND	19	GND
8	Power Good	20	NC
9	5VSB (stand by +5V)	21	+5V
10	+12V	22	+5V
11	+12V (Only for 2x12-pin ATX)	23	+5V (Only for 2x12-pin ATX)
12	3.3V (Only for 2x12-pin ATX)	24	GND (Only for 2x12-pin ATX)

3/4) CPU_FAN/SYS_FAN1/2/3/4 (Fan Headers)

All fan headers on this motherboard are 4-pin. Most fan headers possess a foolproof insertion design. When connecting a fan cable, be sure to connect it in the correct orientation (the black connector wire is the ground wire). The speed control function requires the use of a fan with fan speed control design. For optimum heat dissipation, it is recommended that a system fan be installed inside the chassis.

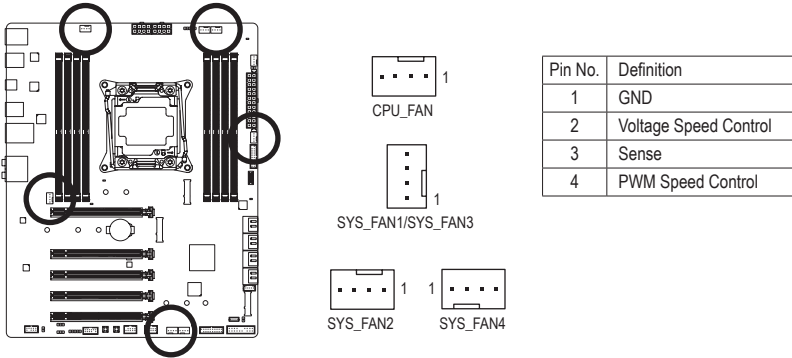

5) CPU_OPT (Water Cooling CPU Fan Header)

The fan header is 4-pin and possesses a foolproof insertion design. Most fan headers possess a foolproof insertion design. When connecting a fan cable, be sure to connect it in the correct orientation (the black connector wire is the ground wire). The speed control function requires the use of a fan with fan speed control design.

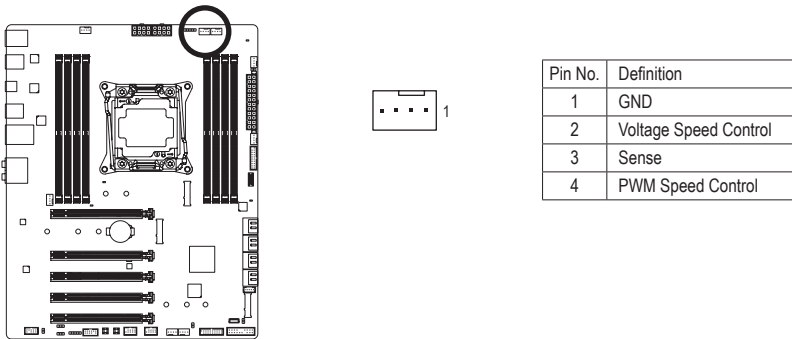

- Be sure to connect fan cables to the fan headers to prevent your CPU and system from overheating. Overheating may result in damage to the CPU or the system may hang.
- These fan headers are not configuration jumper blocks. Do not place a jumper cap on the headers.

6) SYS_FAN5_PUMP (System Fan/Water Cooling Pump Header)

The fan/pump header is 4-pin and possesses a foolproof insertion design. Most fan headers possess a foolproof insertion design. When connecting a fan cable, be sure to connect it in the correct orientation (the black connector wire is the ground wire). The speed control function requires the use of a fan with fan speed control design. For optimum heat dissipation, it is recommended that a system fan be installed inside the chassis. The header also provides speed control for a water cooling pump, refer to Chapter 2, "BIOS Setup," "M.I.T.," for more information

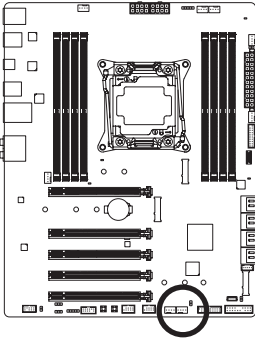

Pin No.	Definition
1	GND
2	Voltage Speed Control
3	Sense
4	PWM Speed Control

7) HPWR_FAN_PUMP (3 Amp Fan/Water Cooling Pump Header)

The fan/pump header is 4-pin and possesses a foolproof insertion design. Most fan headers possess a foolproof insertion design. When connecting a fan cable, be sure to connect it in the correct orientation (the black connector wire is the ground wire). The speed control function requires the use of a fan with fan speed control design. The header also provides speed control for a water cooling pump, refer to Chapter 2, "BIOS Setup," "M.I.T.," for more information

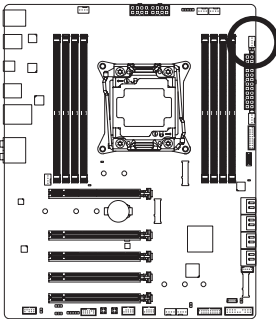

Pin No.	Definition
1	GND
2	Voltage Speed Control
3	Sense
4	PWM Speed Control



Because a 3 Amp fan can run very fast, DO NOT touch it when it is operating to avoid injury.

8) EC_TEMP1/EC_TEMP2 (Temperature Sensor Headers)

Connect the thermistor cables to the headers for temperature detection.

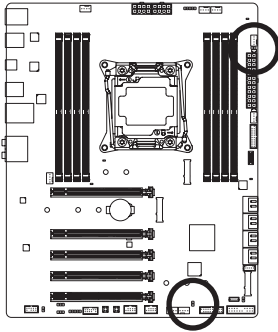

1
EC_TEMP1

Pin No.	Definition
1	SENSOR IN
2	GND

1
EC_TEMP2

9) SATA3 0/1/2/3/4/5/6/7 (SATA 6Gb/s Connectors)

The SATA connectors conform to SATA 6Gb/s standard and are compatible with SATA 3Gb/s and SATA 1.5Gb/s standard. Each SATA connector supports a single SATA device. The Intel® Chipset supports RAID 0, RAID 1, RAID 5, and RAID 10. Refer to Chapter 3, "Configuring a RAID Set," for instructions on configuring a RAID array.

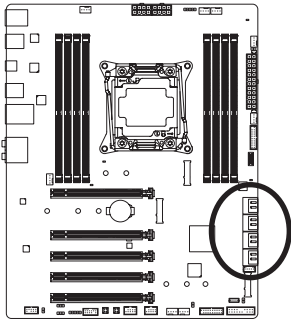

SATA3

7	5	3	1
6	4	2	0

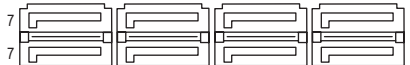

Pin No.	Definition
1	GND
2	TXP
3	TXN
4	GND
5	RXN
6	RXP
7	GND



To enable hot-plugging for the SATA ports, refer to Chapter 2, "BIOS Setup," "Peripherals\SATA And RST Configuration," for more information.

10) M2P_32G/M2M_32G^(Note)/M2Q_32G (M.2 Socket 3 Connectors)

The M.2 connectors support M.2 SATA SSDs or M.2 PCIe SSDs and support RAID configuration. Please note that an M.2 PCIe SSD cannot be used to create a RAID set either with an M.2 SATA SSD or a SATA hard drive. To create a RAID array with an M.2 PCIe SSD, you must set up the configuration in UEFI BIOS mode. Refer to Chapter 3, "Configuring a RAID Set," for instructions on configuring a RAID array.

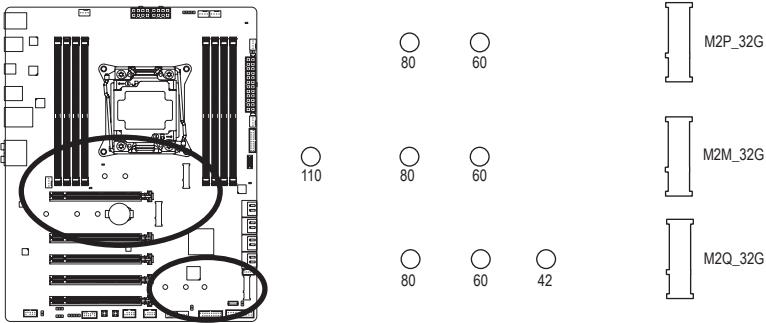

Follow the steps below to correctly install an M.2 SSD in the M.2 connector.



Step 1:
Get a screw and a standoff from the included M.2 screw kit. Locate the M.2 connector where you will install the M.2 SSD, use a screwdriver to unfasten the screw on the heatsink and then remove the heatsink. (Only the M2Q_32G connector has the heatsink)

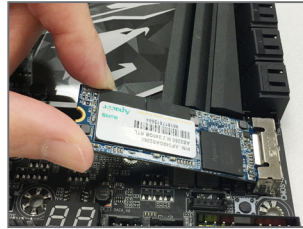

Step 2:
Locate the proper mounting hole for the M.2 SSD to be installed and then tighten the standoff first. Insert the M.2 SSD into the M.2 connector at an angle.



Step 3:
Press the M.2 SSD down and then secure it with the screw. Replace the heatsink and secure it to the original hole.



Step 4:
The installation is completed, as shown in the picture above.

(Note) The M2M_32G connector must work with an Intel® VROC Upgrade Key to support RAID configuration.



Select the proper hole for the M.2 SSD to be installed and refasten the screw and nut.

Installation Notices for the M.2 and SATA Connectors:

Due to the limited number of lanes provided by the Chipset, the availability of the SATA connectors may be affected by the type of device installed in the M2P_32G and M2Q_32G connectors. The M2P_32G connector shares bandwidth with the SATA3 0 connector. The M2Q_32G connector shares bandwidth with the SATA3 4, 5, 6, 7 connectors. Refer to the following tables for details.

- M2P_32G:

Type of M.2 SSD \ Connector	SATA3 0	SATA3 1	SATA3 2	SATA3 3	SATA3 4	SATA3 5	SATA3 6	SATA3 7
M.2 SATA SSD	✘	✓	✓	✓	✓	✓	✓	✓
M.2 PCIe SSD	✓	✓	✓	✓	✓	✓	✓	✓
No M.2 SSD Installed	✓	✓	✓	✓	✓	✓	✓	✓

✓ : Available, ✘ : Not available

- M2M_32G:

Type of M.2 SSD \ Connector	SATA3 0	SATA3 1	SATA3 2	SATA3 3	SATA3 4	SATA3 5	SATA3 6	SATA3 7
M.2 PCIe SSD *	✓	✓	✓	✓	✓	✓	✓	✓
No M.2 SSD Installed	✓	✓	✓	✓	✓	✓	✓	✓

✓ : Available, ✘ : Not available

* The M2M_32G connector supports only PCIe SSDs.

- M2Q_32G:

Type of M.2 SSD \ Connector	SATA3 0	SATA3 1	SATA3 2	SATA3 3	SATA3 4	SATA3 5	SATA3 6	SATA3 7
M.2 SATA SSD	✓	✓	✓	✓	✘	✘	✘	✘
M.2 PCIe SSD	✓	✓	✓	✓	✘	✘	✘	✘
No M.2 SSD Installed	✓	✓	✓	✓	✓	✓	✓	✓

✓ : Available, ✘ : Not available

11) D_LED (Digital LED Strip Header)

The header can be used to connect a standard 5050 digital LED strip, with maximum power rating of 2A (12V or 5V) and maximum length of 5m or maximum number of 300 LEDs.

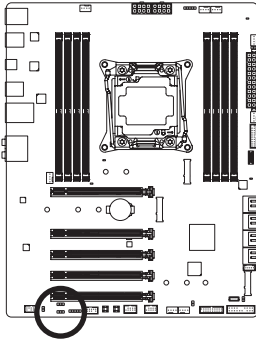

Pin No.	Definition
1	V
2	D
3	G

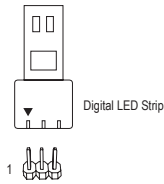

Connect your digital LED strip to the header. There are 12V and 5V digital LED strips. Be sure to verify the voltage requirements of your digital LED strip and set the DLED_V_SW jumper accordingly. The power pin (marked with a triangle on the plug) of the LED strip must be connected to Pin 1 of the digital LED strip header. Incorrect connection may lead to the damage of the LED strip.



For how to turn on/off the lights of the LED strip, refer to the instructions on in Chapter 2, "BIOS Setup," "Peripherals," or Chapter 5, "Unique Features," "APP Center/RGB Fusion."



Before installing the devices, be sure to turn off the devices and your computer. Unplug the power cord from the power outlet to prevent damage to the devices.

12) DLED_V_SW (Digital LED Strip Power Select Jumper)

This jumper allows you to select the supply voltage of the D_LED header. Be sure to verify the voltage requirements of your digital LED strip and set the correct voltage with this jumper before connection. Incorrect connection may lead to the damage of the LED strip.

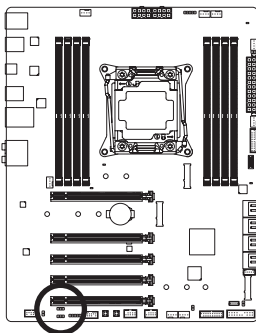

1-2: 5V

2-3: 12V

13) LED_C1/LED_C2 (RGB (RGBW) LED Strip Extension Cable Headers)

The headers can be used to connect a standard 5050 RGB (RGBW) LED strip (12V/G/R/B/W), with maximum power rating of 2A (12V) and maximum length of 2m.

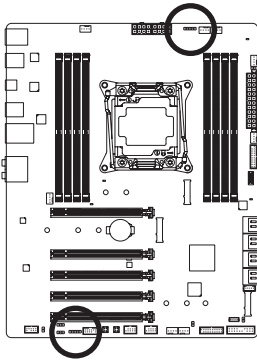

Pin No.	Definition
1	12V
2	G
3	R
4	B
5	W

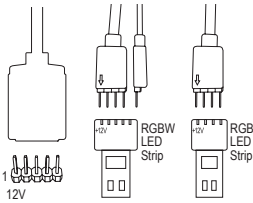

Connect one end of the RGB (RGBW) LED strip extension cable to the header and the other end to your RGB (RGBW) LED strip. The black wire (marked with a triangle on the plug) of the extension cable must be connected to Pin 1 (12V) of this header. The 12V pin (marked with an arrow) on the other end of the extension cable must be lined up with the 12V of the LED strip. Be careful with the connection orientation of the LED strip; incorrect connection may lead to the damage of the LED strip. If you are connecting a RGBW LED strip (5-pin), combine the two plugs of the extension cable together first. If you are connecting a RGB LED strip (4-pin), use only the 4-pin plug of the extension cable.



For how to turn on/off the lights of the LED strip, refer to the instructions on in Chapter 2, "BIOS Setup," "Peripherals," or Chapter 5, "Unique Features," "APP Center/RGB Fusion."



Before installing the devices, be sure to turn off the devices and your computer. Unplug the power cord from the power outlet to prevent damage to the devices.

14) F_PANEL (Front Panel Header)

Connect the power switch, reset switch, speaker, chassis intrusion switch/sensor and system status indicator on the chassis to this header according to the pin assignments below. Note the positive and negative pins before connecting the cables.

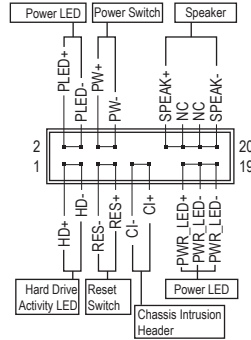
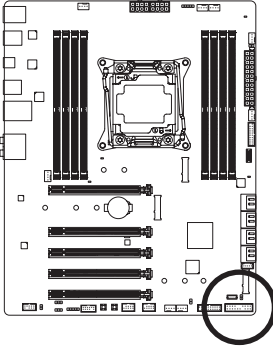

- **PLED/PWR_LED** (Power LED, Yellow/Purple):

System Status	LED
S0	On
S3/S4/S5	Off

Connects to the power status indicator on the chassis front panel. The LED is on when the system is operating. The LED is off when the system is in S3/S4 sleep state or powered off (S5).

- **PW** (Power Switch, Red):

Connects to the power switch on the chassis front panel. You may configure the way to turn off your system using the power switch (refer to Chapter 2, "BIOS Setup," "Power," for more information).

- **SPEAK** (Speaker, Orange):

Connects to the speaker on the chassis front panel. The system reports system startup status by issuing a beep code. One single short beep will be heard if no problem is detected at system startup.

- **HD** (Hard Drive Activity LED, Blue):

Connects to the hard drive activity LED on the chassis front panel. The LED is on when the hard drive is reading or writing data.

- **RES** (Reset Switch, Green):

Connects to the reset switch on the chassis front panel. Press the reset switch to restart the computer if the computer freezes and fails to perform a normal restart.

- **CI** (Chassis Intrusion Header, Gray):

Connects to the chassis intrusion switch/sensor on the chassis that can detect if the chassis cover has been removed. This function requires a chassis with a chassis intrusion switch/sensor.

- **NC** (Orange): No Connection.



The front panel design may differ by chassis. A front panel module mainly consists of power switch, reset switch, power LED, hard drive activity LED, speaker and etc. When connecting your chassis front panel module to this header, make sure the wire assignments and the pin assignments are matched correctly.

15) F_AUDIO (Front Panel Audio Header)

The front panel audio header supports Intel High Definition audio (HD). You may connect your chassis front panel audio module to this header. Make sure the wire assignments of the module connector match the pin assignments of the motherboard header. Incorrect connection between the module connector and the motherboard header will make the device unable to work or even damage it.

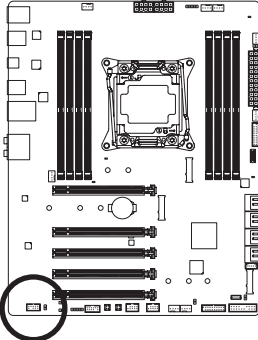

Pin No.	Definition
1	MIC2_L
2	GND
3	MIC2_R
4	NC
5	LINE2_R
6	Sense
7	GND
8	No Pin
9	LINE2_L
10	Sense



- The front panel audio header supports HD audio by default.
- Audio signals will be present on both of the front and back panel audio connections simultaneously.
- Some chassis provide a front panel audio module that has separated connectors on each wire instead of a single plug. For information about connecting the front panel audio module that has different wire assignments, please contact the chassis manufacturer.

16) SPDIF_O (S/PDIF Out Header)

This header supports digital S/PDIF Out and connects a S/PDIF digital audio cable (provided by expansion cards) for digital audio output from your motherboard to certain expansion cards like graphics cards and sound cards. For example, some graphics cards may require you to use a S/PDIF digital audio cable for digital audio output from your motherboard to your graphics card if you wish to connect an HDMI display to the graphics card and have digital audio output from the HDMI display at the same time. For information about connecting the S/PDIF digital audio cable, carefully read the manual for your expansion card.

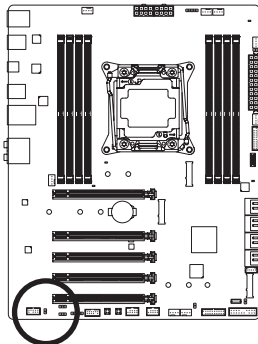

Pin No.	Definition
1	SPDIFO
2	GND

17) F_USB31C (USB 3.1 Gen 2 Header)

The header conforms to USB 3.1 Gen 2 specification and can provide one USB port.

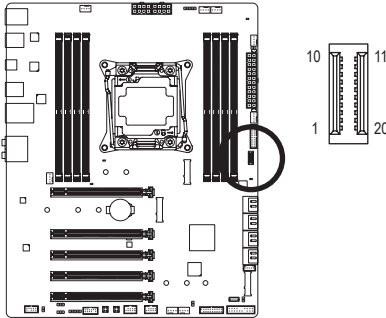

Pin No.	Definition	Pin No.	Definition
1	VBUS	11	VBUS
2	TX1+	12	TX2+
3	TX1-	13	TX2-
4	GND	14	GND
5	RX1+	15	RX2+
6	RX1-	16	RX2-
7	VBUS	17	GND
8	CC1	18	D-
9	SBU1	19	D+
10	SBU2	20	CC2

18) F_USB30_1/F_USB30_2 (USB 3.1 Gen 1 Headers)

The headers conform to USB 3.1 Gen 1 and USB 2.0 specification and each header can provide two USB ports. For purchasing the optional 3.5" front panel that provides two USB 3.1 Gen 1 ports, please contact the local dealer.

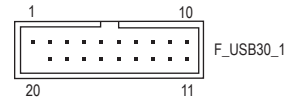
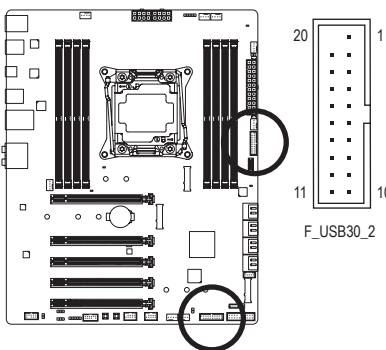

Pin No.	Definition	Pin No.	Definition
1	VBUS	11	D2+
2	SSRX1-	12	D2-
3	SSRX1+	13	GND
4	GND	14	SSTX2+
5	SSTX1-	15	SSTX2-
6	SSTX1+	16	GND
7	GND	17	SSRX2+
8	D1-	18	SSRX2-
9	D1+	19	VBUS
10	NC	20	No Pin



Prior to installing the USB bracket, be sure to turn off your computer and unplug the power cord from the power outlet to prevent damage to the USB bracket.

19) F_USB1/F_USB2 (USB 2.0/1.1 Headers)

The headers conform to USB 2.0/1.1 specification. Each USB header can provide two USB ports via an optional USB bracket. For purchasing the optional USB bracket, please contact the local dealer.

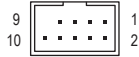
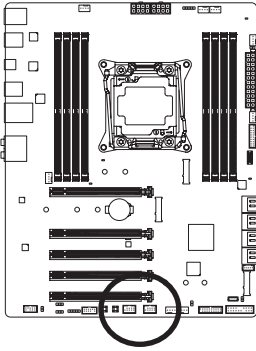

Pin No.	Definition
1	Power (5V)
2	Power (5V)
3	USB DX-
4	USB DY-
5	USB DX+
6	USB DY+
7	GND
8	GND
9	No Pin
10	NC



- Do not plug the IEEE 1394 bracket (2x5-pin) cable into the USB 2.0/1.1 header.
- Prior to installing the USB bracket, be sure to turn off your computer and unplug the power cord from the power outlet to prevent damage to the USB bracket.

20) TPM (Trusted Platform Module Header)

You may connect a TPM (Trusted Platform Module) to this header.

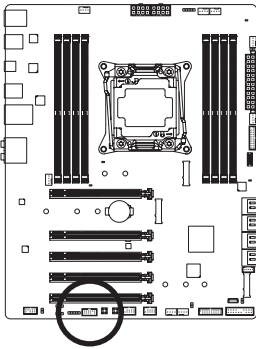

Pin No.	Definition
1	LAD0
2	VCC3
3	LAD1
4	No Pin
5	LAD2
6	LCLK
7	LAD3
8	GND
9	LFRAME
10	NC
11	SERIRQ
12	LRESET

21) THB_C (Thunderbolt™ Add-in Card Connector)

This connector is for a GIGABYTE Thunderbolt™ add-in card.

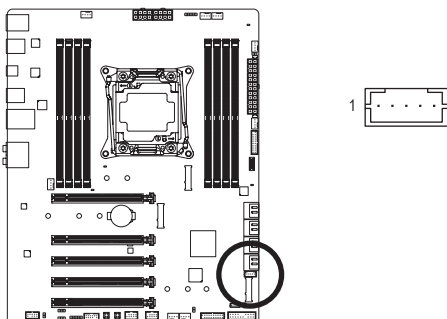

Supports a Thunderbolt™ add-in card.

22) BAT (Battery)

The battery provides power to keep the values (such as BIOS configurations, date, and time information) in the CMOS when the computer is turned off. Replace the battery when the battery voltage drops to a low level, or the CMOS values may not be accurate or may be lost.

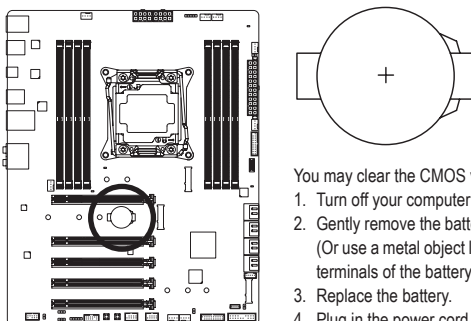

You may clear the CMOS values by removing the battery:

1. Turn off your computer and unplug the power cord.
2. Gently remove the battery from the battery holder and wait for one minute. (Or use a metal object like a screwdriver to touch the positive and negative terminals of the battery holder, making them short for 5 seconds.)
3. Replace the battery.
4. Plug in the power cord and restart your computer.



- Always turn off your computer and unplug the power cord before replacing the battery.
- Replace the battery with an equivalent one. Damage to your devices may occur if the battery is replaced with an incorrect model.
- Contact the place of purchase or local dealer if you are not able to replace the battery by yourself or uncertain about the battery model.
- When installing the battery, note the orientation of the positive side (+) and the negative side (-) of the battery (the positive side should face up).
- Used batteries must be handled in accordance with local environmental regulations.

23) CLR_CMOS (Clear CMOS Jumper)

Use this jumper to clear the BIOS configuration and reset the CMOS values to factory defaults. To clear the CMOS values, use a metal object like a screwdriver to touch the two pins for a few seconds.

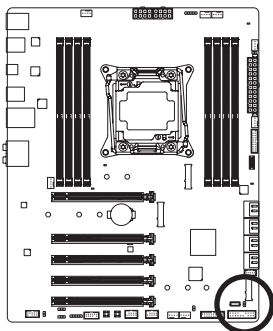

Open: Normal



Short: Clear CMOS Values



- Always turn off your computer and unplug the power cord from the power outlet before clearing the CMOS values.
- After system restart, go to BIOS Setup to load factory defaults (select Load Optimized Defaults) or manually configure the BIOS settings (refer to Chapter 2, "BIOS Setup," for BIOS configurations).

24) VROC (Intel® VROC Upgrade Key Header)

This header can be used to connected an Intel® VROC Upgrade Key.

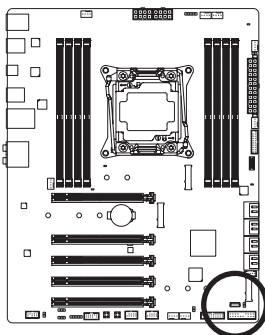

1



Chapter 2 BIOS Setup

BIOS (Basic Input and Output System) records hardware parameters of the system in the CMOS on the motherboard. Its major functions include conducting the Power-On Self-Test (POST) during system startup, saving system parameters and loading operating system, etc. BIOS includes a BIOS Setup program that allows the user to modify basic system configuration settings or to activate certain system features.

When the power is turned off, the battery on the motherboard supplies the necessary power to the CMOS to keep the configuration values in the CMOS.

To access the BIOS Setup program, press the <Delete> key during the POST when the power is turned on.

To upgrade the BIOS, use either the GIGABYTE Q-Flash or @BIOS utility.

- Q-Flash allows the user to quickly and easily upgrade or back up BIOS without entering the operating system.
- @BIOS is a Windows-based utility that searches and downloads the latest version of BIOS from the Internet and updates the BIOS.

For instructions on using the Q-Flash and @BIOS utilities, refer to Chapter 5, "BIOS Update Utilities."



- Because BIOS flashing is potentially risky, if you do not encounter problems using the current version of BIOS, it is recommended that you not flash the BIOS. To flash the BIOS, do it with caution. Inadequate BIOS flashing may result in system malfunction.
- It is recommended that you not alter the default settings (unless you need to) to prevent system instability or other unexpected results. Inadequately altering the settings may result in system's failure to boot. If this occurs, try to clear the CMOS values and reset the board to default values. (Refer to the "Load Optimized Defaults" section in this chapter or introductions of the battery/clear CMOS jumper in Chapter 1 for how to clear the CMOS values.)

2-1 Startup Screen

The following startup Logo screen will appear when the computer boots.

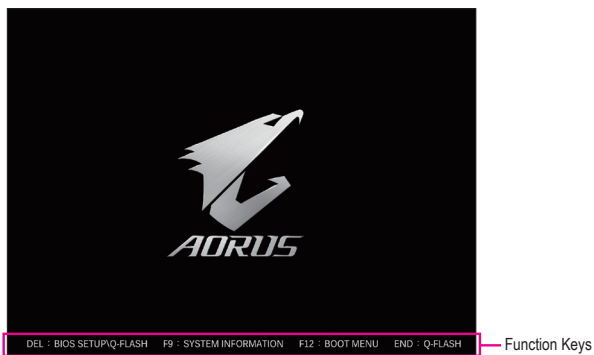

Function Keys:

: BIOS SETUP/Q-FLASH

Press the <Delete> key to enter BIOS Setup or to access the Q-Flash utility in BIOS Setup.

<F9>: SYSTEM INFORMATION

Press the <F9> key to display your system information.

<F12>: BOOT MENU

Boot Menu allows you to set the first boot device without entering BIOS Setup. In Boot Menu, use the up arrow key <↑> or the down arrow key <↓> to select the first boot device, then press <Enter> to accept. The system will boot from the device immediately.

Note: The setting in Boot Menu is effective for one time only. After system restart, the device boot order will still be based on BIOS Setup settings.

<END>: Q-FLASH

Press the <End> key to access the Q-Flash utility directly without having to enter BIOS Setup first.

2-2 The Main Menu

Classic Setup

The Classic Setup mode provides detailed BIOS settings. You can press the arrow keys on your keyboard to move among the items and press <Enter> to accept or enter a sub-menu. Or you can use your mouse to select the item you want.

(Sample BIOS Version: F1a)

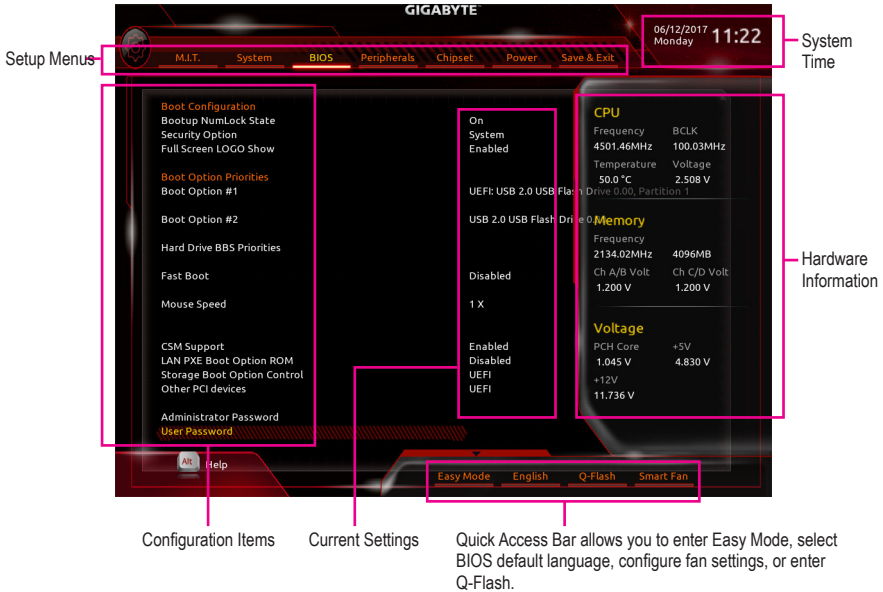

Classic Setup Function Keys

<←><→>	Move the selection bar to select a setup menu
<↑><↓>	Move the selection bar to select an configuration item on a menu
<Enter>	Execute command or enter a menu
<+>/<Page Up>	Increase the numeric value or make changes
<->/<Page Down>	Decrease the numeric value or make changes
<F1>	Show descriptions of the function keys
<F2>	Switch to Easy Mode
<F5>	Restore the previous BIOS settings for the current submenus
<F7>	Load the Optimized BIOS default settings for the current submenus
<F8>	Access the Q-Flash utility
<F9>	Display system information
<F10>	Save all the changes and exit the BIOS Setup program
<F12>	Capture the current screen as an image and save it to your USB drive
<Esc>	Main Menu: Exit the BIOS Setup program Submenus: Exit current submenu

B. Easy Mode

Easy Mode allows users to quickly view their current system information or to make adjustments for optimum performance. In Easy Mode, you can use your mouse to move through configuration items or press <F2> to switch to the Classic Setup screen.

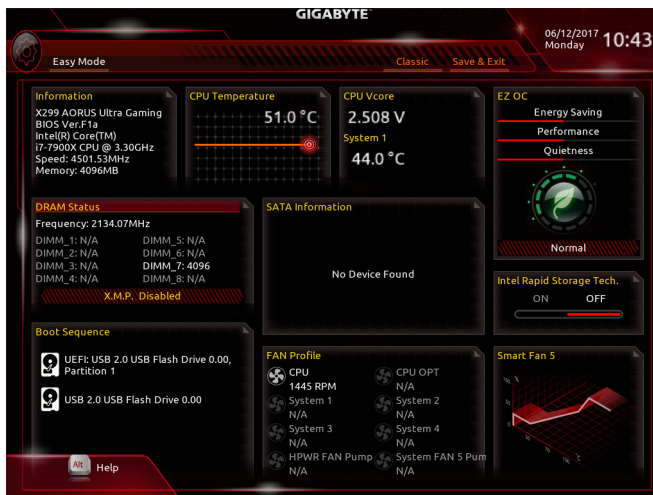

2-3 M.I.T.



Whether the system will work stably with the overclock/overvoltage settings you made is dependent on your overall system configurations. Incorrectly doing overclock/overvoltage may result in damage to CPU, chipset, or memory and reduce the useful life of these components. This page is for advanced users only and we recommend you not to alter the default settings to prevent system instability or other unexpected results. (Inadequately altering the settings may result in system's failure to boot. If this occurs, clear the CMOS values and reset the board to default values.)

▶ Advanced Frequency Settings



🔗 CPU BCLK Frequency

Allows you to manually set the CPU base clock in 0.01 MHz increments. (Default: Auto)

Important: It is highly recommended that the CPU frequency be set in accordance with the CPU specifications.

☞ **PCIe/DMI/PEG Frequency**

Allows you to manually set the host clock frequency (which controls CPU, PCIe, and memory frequencies) in 0.01 MHz increments.

☞ **BCLK Coarse Ratio** ^(Note)

This value is determined by multiplying the **PCIe/DMI/PEG Frequency** value by several preset host clock multipliers.

☞ **Target CPU BCLK Frequency**

Displays the current CPU BCLK Frequency.

☞ **Spread Spectrum Control** ^(Note)

Enables or disables CPU/PCIe Spread Spectrum. (Default: Auto)

☞ **CPU Upgrade** ^(Note)

Allows you to set the CPU frequency. Options may vary depending on the CPU being used. (Default: Auto)

☞ **CPU Clock Ratio**

Allows you to alter the clock ratio for the installed CPU. The adjustable range is dependent on the CPU being installed.

☞ **CPU Frequency**

Displays the current operating CPU frequency.

▶ **Advanced CPU Core Settings**



☞ **CPU Clock Ratio, CPU Frequency**

The settings above are synchronous to those under the same items on the **Advanced Frequency Settings** menu.

☞ **FCLK Frequency for Early Power On** ^(Note)

Allows you to set the FCLK frequency. Options are: 800Mhz, 1GHz, 400MHz. 1GHz is the default.

(Note) This item is present only when you install a CPU that supports this feature. For more information about Intel® CPUs' unique features, please visit Intel's website.

- ☞ **AVX Offset** ^(Note)
 AVX offset is the negative offset of AVX ratio.
- ☞ **AVX 512** ^(Note)
 Allows you to configure AVX 512 instructions. (Default: Auto)
- ☞ **TJ-Max Offset** ^(Note)
 Allows you to fine-tune the TJ Max offset value. (Default: 0)
- ☞ **CPU PLL Trim** ^(Note)/**MC PLL Trim** ^(Note)/**PLL Trim Threshold** ^(Note)
 Allows you to fine-tune CPU/MC PLL related settings. (Default: Auto)
- ☞ **Turbo Residency Tweak LUT0~LUT3** ^(Note)
 Allows you to fine-tune the Turbo Residency related settings. (Default: Auto)
- ☞ **Uncore Ratio**
 Allows you to set the CPU Uncore ratio. The adjustable range is dependent on the CPU being used.
- ☞ **Uncore Frequency**
 Displays the current CPU Uncore frequency.
- ☞ **CPU Flex Ratio Override** ^(Note)
 Enables or disables the CPU Flex Ratio. The maximum CPU clock ratio will be based on the **CPU Flex Ratio Settings** value if **CPU Clock Ratio** is set to **Auto**. (Default: Disabled)
- ☞ **CPU Flex Ratio Settings** ^(Note)
 Allows you to set the CPU Flex Ratio. The adjustable range may vary by CPU.
- ☞ **Intel(R) Turbo Boost Technology** ^(Note)
 Allows you to determine whether to enable the Intel® CPU Turbo Boost technology. **Auto** lets the BIOS automatically configure this setting. (Default: Auto)
- ☞ **Turbo Ratio** ^(Note)
 Allows you to set the CPU Turbo ratios for different number of active cores. **Auto** sets the CPU Turbo ratios according to the CPU specifications. (Default: Auto)
- ☞ **Intel(R) Turbo Boost Max Technology 3.0** ^(Note)
 Enables or disables Intel® Turbo Boost Max Technology 3.0. Intel® Turbo Boost Max Technology 3.0 allows the system to identify the processor's best performance core and lets you manually direct the most critical workloads to it. You can even adjust the frequency of each core individually for performance optimization. **Auto** lets the BIOS automatically configure this setting. (Default: Auto)
- ☞ **Turbo Per Core Limit Control** ^(Note)
 Allows you to control each CPU core limit separately. (Default: Auto)
- ☞ **Power Limit TDP (Watts) / Power Limit Time**
 Allows you to set the power limit for CPU Turbo mode and how long it takes to operate at the specified power limit. If the specified value is exceeded, the CPU will automatically reduce the core frequency in order to reduce the power. **Auto** sets the power limit according to the CPU specifications. (Default: Auto)
- ☞ **Core Current Limit (Amps)**
 Allows you to set a current limit for CPU Turbo mode. When the CPU current exceeds the specified current limit, the CPU will automatically reduce the core frequency in order to reduce the current. **Auto** sets the power limit according to the CPU specifications. (Default: Auto)
- ☞ **Active Cores Control** ^(Note)
 Allows you to select the number of CPU cores to enable in an Intel® multi-core CPU (the number of CPU cores may vary by CPU). **Auto** lets the BIOS automatically configure this setting. (Default: Auto)

(Note) This item is present only when you install a CPU that supports this feature. For more information about Intel® CPUs' unique features, please visit Intel's website.

- ☞ **No. of CPU Cores Enabled** ^(Note)
 Allows you to select the number of CPU cores to enable in an Intel® multi-core CPU (the number of CPU cores may vary by CPU). **Auto** lets the BIOS automatically configure this setting. (Default: Auto)
- ☞ **Hyper-Threading Technology** ^(Note)
 Allows you to determine whether to enable multi-threading technology when using an Intel® CPU that supports this function. This feature only works for operating systems that support multi-processor mode. **Auto** lets the BIOS automatically configure this setting. (Default: Auto)
- ☞ **Intel(R) Speed Shift Technology (Intel® Speed Shift Technology)** ^(Note)
 Enables or disables Intel® Speed Shift Technology. Enabling this feature allows the processor to ramp up its operating frequency more quickly and then improves the system responsiveness. (Default: Disabled)
- ☞ **Hardware P-States** ^(Note)
 Allows you to specify a hardware P-state. Options are: Disabled, Native Mode, Out of Band Mode, Native Mode with No Legacy Support. (Default: Native Mode)
- ☞ **HardwarePM Interrupt** ^(Note)
 Enables or disables hardware PM interrupt. (Default: Disabled)
- ☞ **EPP Enable** ^(Note)
 Enables or disables the EPP function. (Default: Enabled)
- ☞ **CPU Enhanced Halt (C1E)** ^(Note)
 Enables or disables Intel® CPU Enhanced Halt (C1E) function, a CPU power-saving function in system halt state. When enabled, the CPU core frequency and voltage will be reduced during system halt state to decrease power consumption. **Auto** lets the BIOS automatically configure this setting. (Default: Auto)
- ☞ **C3 State Support** ^(Note)
 Allows you to determine whether to let the CPU enter C3 mode in system halt state. When enabled, the CPU core frequency and voltage will be reduced during system halt state to decrease power consumption. The C3 state is a more enhanced power-saving state than C1. **Auto** lets the BIOS automatically configure this setting. (Default: Auto)
- ☞ **C6/C7 State Support** ^(Note)
 Allows you to determine whether to let the CPU enter C6/C7 mode in system halt state. When enabled, the CPU core frequency and voltage will be reduced during system halt state to decrease power consumption. The C6/C7 state is a more enhanced power-saving state than C3. **Auto** lets the BIOS automatically configure this setting. (Default: Auto)
- ☞ **C8 State Support** ^(Note)
 Allows you to determine whether to let the CPU enter C8 mode in system halt state. When enabled, the CPU core frequency and voltage will be reduced during system halt state to decrease power consumption. The C8 state is a more enhanced power-saving state than C6/C7. **Auto** lets the BIOS automatically configure this setting. (Default: Auto)
- ☞ **Package C State Limit** ^(Note)
 Allows you to specify the C-state limit for the processor. **Auto** lets the BIOS automatically configure this setting. (Default: Auto)
- ☞ **CPU Thermal Monitor** ^(Note)
 Enables or disables Intel® Thermal Monitor function, a CPU overheating protection function. When enabled, the CPU core frequency and voltage will be reduced when the CPU is overheated. **Auto** lets the BIOS automatically configure this setting. (Default: Auto)

(Note) This item is present only when you install a CPU that supports this feature. For more information about Intel® CPUs' unique features, please visit Intel's website.

- ☞ **CPU EIST Function** ^(Note 1)
 Enables or disables Enhanced Intel® Speed Step Technology (EIST). Depending on CPU loading, Intel® EIST technology can dynamically and effectively lower the CPU voltage and core frequency to decrease average power consumption and heat production. **Auto** lets the BIOS automatically configure this setting. (Default: Auto)
- ☞ **Race To Halt (RTH)** ^(Note 1)/**Energy Deficient Turbo** ^(Note 1)
 Enables or disables the CPU power saving related settings.
- ☞ **Voltage Optimization** ^(Note 1)
 Allows you to determine whether to enable voltage optimization to reduce power consumption. (Default: Auto)
- ☞ **RSR** ^(Note 1)
 Allows you to determine whether to automatically lower the CPU turbo ratio if the CPU voltage/temperature is too high. (Default: Auto)
- ☞ **Hardware Prefetcher**
 Allows you to determine whether to enable hardware prefetcher to prefetch data and instructions from the memory into the cache. (Default: Auto)
- ☞ **Adjacent Cache Line Prefetch**
 Allows you to determine whether to enable the adjacent cache line prefetch mechanism that lets the processor retrieve the requested cache line as well as the subsequent cache line. (Default: Auto)
- ☞ **Extreme Memory Profile (X.M.P.)** ^(Note 2)
 Allows the BIOS to read the SPD data on XMP memory module(s) to enhance memory performance when enabled.

 - ▶▶ Disabled Disables this function. (Default)
 - ▶▶ Profile1 Uses Profile 1 settings.
 - ▶▶ Profile2 ^(Note 2) Uses Profile 2 settings.
- ☞ **System Memory Multiplier**
 Allows you to set the system memory multiplier. **Auto** sets memory multiplier according to memory SPD data. (Default: Auto)
- ☞ **Memory Ref Clock**
 Allows you to manually adjust the memory reference clock. (Default: Auto)
- ☞ **Memory Odd Ratio (100/133 or 200/266)** ^(Note 2)
Enabled allows Qclk to run in odd frequency. (Default: Auto)
- ☞ **Memory Frequency (MHz)**
 The first memory frequency value is the normal operating frequency of the memory being used; the second is the memory frequency that is automatically adjusted according to the **System Memory Multiplier** settings.

(Note 1) This item is present only when you install a CPU that supports this feature. For more information about Intel® CPUs' unique features, please visit Intel's website.

(Note 2) This item is present only when you install a CPU and a memory module that support this feature.

▶ Advanced Memory Settings



☞ **Extreme Memory Profile (X.M.P.)** ^(Note), **System Memory Multiplier**, **Memory Ref Clock**, **Memory Odd Ratio (100/133 or 200/266)** ^(Note), **Memory Frequency(MHz)**

The settings above are synchronous to those under the same items on the **Advanced Frequency Settings** menu.

☞ **Memory Boot Mode** ^(Note)

Provides memory detection and training methods.

- ▶▶ Auto Lets the BIOS automatically configure this setting. (Default)
- ▶▶ Normal The BIOS automatically performs memory training. Please note that if the system becomes unstable or unbootable, try to clear the CMOS values and reset the board to default values. (Refer to the introductions of the battery/clear CMOS jumper in Chapter 1 for how to clear the CMOS values.)
- ▶▶ Enable Fast Boot Skip memory detection and training in some specific criteria for faster memory boot.
- ▶▶ Disable Fast Boot Detect and train memory at every single boot.

☞ **Memory Enhancement Settings**

Provides several memory performance enhancement settings: Normal (basic performance), Relax OC, Enhanced Stability, and Enhanced Performance. (Default: Normal)

☞ **Memory Timing Mode**

Manual and **Advanced Manual** allows the **Memory Multiplier Tweaker**, **Channel Interleaving**, **Rank Interleaving**, and memory timing settings below to be configurable. Options are: Auto (default), Manual, Advanced Manual.

☞ **Profile DDR Voltage**

When using a non-XMP memory module or **Extreme Memory Profile (X.M.P.)** is set to **Disabled**, the value is displayed according to your memory specification. When **Extreme Memory Profile (X.M.P.)** is set to **Profile1** or **Profile2**, the value is displayed according to the SPD data on the XMP memory.

(Note) This item is present only when you install a CPU and a memory module that support this feature.

☞ **Memory Multiplier Tweaker**

Provides different levels of memory auto-tuning. (Default: Auto)

☞ **Channel Interleaving**

Enables or disables memory channel interleaving. **Enabled** allows the system to simultaneously access different channels of the memory to increase memory performance and stability. **Auto** lets the BIOS automatically configure this setting. (Default: Auto)

☞ **Rank Interleaving**

Enables or disables memory rank interleaving. **Enabled** allows the system to simultaneously access different ranks of the memory to increase memory performance and stability. **Auto** lets the BIOS automatically configure this setting. (Default: Auto)

▶ **Channel A/B/C ^(Note)/D ^(Note) Memory Sub Timings**

This sub-menu provides memory timing settings for each channel of memory. The respective timing setting screens are configurable only when **Memory Timing Mode** is set to **Manual** or **Advanced Manual**. Note: Your system may become unstable or fail to boot after you make changes on the memory timings. If this occurs, please reset the board to default values by loading optimized defaults or clearing the CMOS values.

(Note) This item is present only when you install a CPU and a memory module that support this feature.

▶ Advanced Voltage Settings



▶ Advanced Power Settings

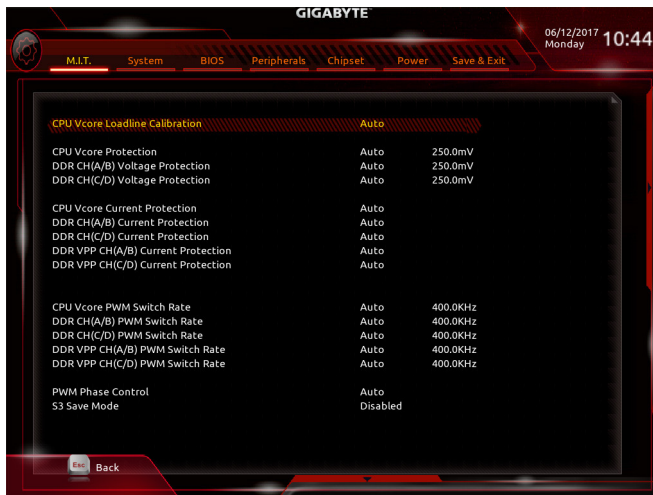

☞ CPU Vcore Loadline Calibration

Allows you to configure Load-Line Calibration for the CPU Vcore voltage. Selecting a higher level keeps the CPU Vcore voltage more consistent with what is set in BIOS under heavy load. **Auto** lets the BIOS automatically configure this setting and sets the voltage following Intel's specifications. (Default: Auto)

☞ CPU Vcore Protection

Allows you to set the over-current protection level for the CPU Vcore voltage. The adjustable range is from 150.0mV to 400.0mV. **Auto** lets the BIOS automatically configure this setting. (Default: Auto)

☞ **DDR CH(A/B) Voltage Protection**

Allows you to set the over-current protection level for Channel A and Channel B memory voltage. The adjustable range is from 150.0mV to 400.0mV. **Auto** lets the BIOS automatically configure this setting. (Default: Auto)

☞ **DDR CH(C/D) Voltage Protection** ^(Note)

Allows you to set the over-current protection level for Channel C and Channel D memory voltage. The adjustable range is from 150.0mV to 400.0mV. **Auto** lets the BIOS automatically configure this setting. (Default: Auto)

☞ **CPU Vcore Current Protection**

Allows you to set the over-current protection level for the CPU Vcore voltage.

- ▶▶ Auto Lets the BIOS automatically configure this setting. (Default)
- ▶▶ Standard~Extreme Selects Standard, Low, Medium, High, Turbo, or Extreme which represents different level of over-current protection for the CPU Vcore voltage.

☞ **DDR CH(A/B) Current Protection**

Allows you to set the over-current protection level for Channel A and Channel B memory voltage.

- ▶▶ Auto Lets the BIOS automatically configure this setting. (Default)
- ▶▶ Standard~Extreme Selects Standard, Low, Medium, High, Turbo, or Extreme which represents different level of over-current protection for the memory voltage.

☞ **DDR CH(C/D) Current Protection** ^(Note)

Allows you to set the over-current protection level for Channel C and Channel D memory voltage.

- ▶▶ Auto Lets the BIOS automatically configure this setting. (Default)
- ▶▶ Standard~Extreme Selects Standard, Low, Medium, High, Turbo, or Extreme which represents different level of over-current protection for the memory voltage.

☞ **DDR VPP CH(A/B) Current Protection**

Allows you to set the over-current protection level for Channel A and Channel B memory voltage.

- ▶▶ Auto Lets the BIOS automatically configure this setting. (Default)
- ▶▶ Standard~Extreme Selects Standard, Low, Medium, High, Turbo, or Extreme which represents different level of over-current protection for the memory voltage.

☞ **DDR VPP CH(C/D) Current Protection** ^(Note)

Allows you to set the over-current protection level for Channel C and Channel D memory voltage.

- ▶▶ Auto Lets the BIOS automatically configure this setting. (Default)
- ▶▶ Standard~Extreme Selects Standard, Low, Medium, High, Turbo, or Extreme which represents different level of over-current protection for the memory voltage.

☞ **CPU Vcore PWM Switch Rate**

Allows you to set the PWM frequency for the CPU Vcore voltage. The adjustable range is from 300.0KHz to 500.0KHz. (Default: Auto)

☞ **DDR CH(A/B) PWM Switch Rate**

Allows you to set the PWM frequency for Channel A and Channel B memory. The adjustable range is from 300.0KHz to 500.0KHz. (Default: Auto)

☞ **DDR CH(C/D) PWM Switch Rate** ^(Note)

Allows you to set the PWM frequency for Channel C and Channel D memory. The adjustable range is from 300.0KHz to 500.0KHz. (Default: Auto)

(Note) This item is present only when you install a CPU that supports this feature.

☞ **DDR VPP CH(A/B) PWM Switch Rate**

Allows you to set the PWM frequency for Channel A and Channel B memory VPP voltage. The adjustable range is from 300.0KHz to 500.0KHz. (Default: Auto)

☞ **DDR CH(C/D) PWM Switch Rate** ^(Note)

Allows you to set the PWM frequency for Channel C and Channel D memory VPP voltage. The adjustable range is from 300.0KHz to 500.0KHz. (Default: Auto)

☞ **PWM Phase Control**

Allows you to automatically change the PWM phase according to the CPU load. The power-saving levels are (from lowest to highest): eXm Perf (Extreme Performance), High Perf (High Performance), Perf (Performance), Balanced, Mid PWR (Mid Power), and Lite PWR (Light Power). **Auto** lets the BIOS automatically configure this setting. (Default: Auto)

☞ **S3 Save Mode**

Determines whether to allow memory voltage drop to a power-saving level when the system is in S3 state. (Default: Disabled)

▶ **CPU Core Voltage Control**

This section provides CPU voltage control options.

▶ **Chipset Voltage Control**

This section provides Chipset voltage control options.

▶ **DRAM Voltage Control**

This section provides memory voltage control options.

▶ **Internal VR Control** ^(Note)

This section provides VR voltage control options.

(Note) This item is present only when you install a CPU that supports this feature.

▶ PC Health Status



⌂ Reset Case Open Status

- ▶ Disabled Keeps or clears the record of previous chassis intrusion status. (Default)
- ▶ Enabled Clears the record of previous chassis intrusion status and the **Case Open** field will show "No" at next boot.

⌂ Case Open

Displays the detection status of the chassis intrusion detection device attached to the motherboard CI header. If the system chassis cover is removed, this field will show "Yes", otherwise it will show "No". To clear the chassis intrusion status record, set **Reset Case Open Status** to **Enabled**, save the settings to the CMOS, and then restart your system.

⌂ CPU Vcore^(Note)/CPU VRIN^(Note)/CPU VCCSA/CPU VCCIO/DRAM Channel A/B Voltage/DRAM Channel C/D Voltage^(Note)/DDRvpp A/B/DDRvpp C/D^(Note)/Internal CPU Vcore^(Note)/CPU MESH Voltage^(Note)/+3.3V/+5V/PCH Core/+12V

Displays the current system voltages.

(Note) This item is present only when you install a CPU that supports this feature.

► Miscellaneous Settings



☞ Max Link Speed

Allows you to set the operation mode of the PCI Express slots to Gen 1, Gen 2, or Gen 3. Actual operation mode is subject to the hardware specification of each slot. **Auto** lets the BIOS automatically configure this setting. (Default: Auto)

☞ 3DMark01 Enhancement

Allows you to determine whether to enhance some legacy benchmark performance. (Default: Disabled)

► Smart Fan 5 Settings

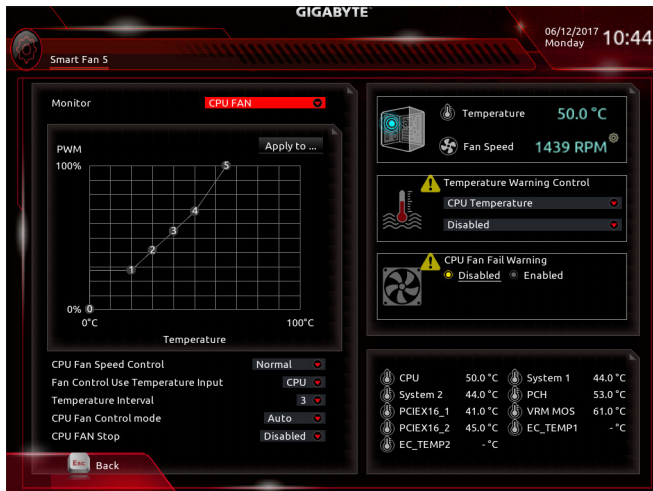

☞ **Monitor**

Allows you to select a target to monitor and to make further adjustment. (Default: CPU FAN)

☞ **Fan Speed Control**

Allows you to determine whether to enable the fan speed control function and adjust the fan speed.

- ▶▶ Normal Allows the fan to run at different speeds according to the temperature. You can adjust the fan speed with System Information Viewer based on your system requirements. (Default)
- ▶▶ Silent Allows the fan to run at slow speeds.
- ▶▶ Manual Allows you to control the fan speed in the curve graph.
- ▶▶ Full Speed Allows the fan to run at full speeds.

☞ **Fan Control Use Temperature Input**

Allows you to select the reference temperature for fan speed control.

☞ **Temperature Interval**

Allows you to select the temperature interval for fan speed change.

☞ **Fan/Pump Control Mode**

- ▶▶ Auto Lets the BIOS automatically detect the type of fan/pump installed and sets the optimal control mode. (Default)
- ▶▶ Voltage Voltage mode is recommended for a 3-pin fan/pump.
- ▶▶ PWM PWM mode is recommended for a 4-pin fan/pump.

☞ **Fan/Pump Stop**

Enables or disables the fan/pump stop function. You can set the temperature limit using the temperature curve. The fan or pump stops operation when the temperature is lower than the limit. (Default: Disabled)

☞ **Temperature**

Displays the current temperature of the selected target area.

☞ **Fan Speed**

Displays current fan/pump speeds.

☞ **Flow Rate**

Displays the flow rate of your water cooling system.

☞ **Temperature Warning Control**

Sets the warning threshold for temperature. When temperature exceeds the threshold, BIOS will emit warning sound. Options are: Disabled (default), 60°C/140°F, 70°C/158°F, 80°C/176°F, 90°C/194°F.

☞ **Fan/Pump Fail Warning**

Allows the system to emit warning sound if the fan/pump is not connected or fails. Check the fan/pump condition or fan/pump connection when this occurs. (Default: Disabled)

2-4 System



This section provides information on your motherboard model and BIOS version. You can also select the default language used by the BIOS and manually set the system time.

Access Level

Displays the current access level depending on the type of password protection used. (If no password is set, the default will display as **Administrator**.) The Administrator level allows you to make changes to all BIOS settings; the User level only allows you to make changes to certain BIOS settings but not all.

System Language

Selects the default language used by the BIOS.

System Date

Sets the system date. The date format is week (read-only), month, date, and year. Use <Enter> to switch between the Month, Date, and Year fields and use the <Page Up> or <Page Down> key to set the desired value.

System Time

Sets the system time. The time format is hour, minute, and second. For example, 1 p.m. is 13:00:00. Use <Enter> to switch between the Hour, Minute, and Second fields and use the <Page Up> or <Page Down> key to set the desired value.

2-5 BIOS



- ☞ **Bootup NumLock State**
Enables or disables Numlock feature on the numeric keypad of the keyboard after the POST. (Default: On)
- ☞ **Security Option**
Specifies whether a password is required every time the system boots, or only when you enter BIOS Setup. After configuring this item, set the password(s) under the **Administrator Password/User Password** item.
 - ▶▶ Setup A password is only required for entering the BIOS Setup program.
 - ▶▶ System A password is required for booting the system and for entering the BIOS Setup program. (Default)
- ☞ **Full Screen LOGO Show**
Allows you to determine whether to display the GIGABYTE Logo at system startup. **Disabled** skips the GIGABYTE Logo when the system starts up. (Default: Enabled)
- ☞ **Boot Option Priorities**
Specifies the overall boot order from the available devices. Removable storage devices that support GPT format will be prefixed with "UEFI:" string on the boot device list. To boot from an operating system that supports GPT partitioning, select the device prefixed with "UEFI:" string.
Or if you want to install an operating system that supports GPT partitioning such as Windows 10 64-bit, select the optical drive that contains the Windows 10 64-bit installation disk and is prefixed with "UEFI:" string.
- ☞ **Hard Drive/CD/DVD ROM Drive/Floppy Drive/Network Device BBS Priorities**
Specifies the boot order for a specific device type, such as hard drives, optical drives, floppy disk drives, and devices that support Boot from LAN function, etc. Press <Enter> on this item to enter the submenu that presents the devices of the same type that are connected. This item is present only if at least one device for this type is installed.
- ☞ **Fast Boot**
Enables or disables Fast Boot to shorten the OS boot process. **Ultra Fast** provides the fastest bootup speed. (Default: Disabled)

☞ **SATA Support**

- ▶▶ All Sata Devices All SATA devices are functional in the operating system and during the POST. (Default)
- ▶▶ Last Boot HDD Only Except for the previous boot drive, all SATA devices are disabled before the OS boot process completes.

This item is configurable only when **Fast Boot** is set to **Enabled** or **Ultra Fast**.

☞ **VGA Support**

Allows you to select which type of operating system to boot.

- ▶▶ Auto Enables legacy option ROM only.
- ▶▶ EFI Driver Enables EFI option ROM. (Default)

This item is configurable only when **Fast Boot** is set to **Enabled** or **Ultra Fast**.

☞ **USB Support**

- ▶▶ Disabled All USB devices are disabled before the OS boot process completes.
- ▶▶ Full Initial All USB devices are functional in the operating system and during the POST.
- ▶▶ Partial Initial Part of the USB devices are disabled before the OS boot process completes. (Default)

This item is configurable only when **Fast Boot** is set to **Enabled**. This function is disabled when **Fast Boot** is set to **Ultra Fast**.

☞ **PS2 Devices Support**

- ▶▶ Disabled All PS/2 devices are disabled before the OS boot process completes.
- ▶▶ Enabled All PS/2 devices are functional in the operating system and during the POST. (Default)

This item is configurable only when **Fast Boot** is set to **Enabled**. This function is disabled when **Fast Boot** is set to **Ultra Fast**.

☞ **NetWork Stack Driver Support**

- ▶▶ Disabled Disables booting from the network. (Default)
- ▶▶ Enabled Enables booting from the network.

This item is configurable only when **Fast Boot** is set to **Enabled** or **Ultra Fast**.

☞ **Next Boot After AC Power Loss**

- ▶▶ Normal Boot Enables normal bootup upon the return of the AC power. (Default)
- ▶▶ Fast Boot Keeps the Fast Boot settings upon the return of the AC power.

This item is configurable only when **Fast Boot** is set to **Enabled** or **Ultra Fast**.

☞ **Mouse Speed**

Allows you to set the mouse cursor movement speed. (Default: 1 X)

☞ **CSM Support**

Enables or disables UEFI CSM (Compatibility Support Module) to support a legacy PC boot process.

- ▶▶ Enabled Enables UEFI CSM. (Default)
- ▶▶ Disabled Disables UEFI CSM and supports UEFI BIOS boot process only.

☞ **LAN PXE Boot Option ROM**

Allows you to select whether to enable the legacy option ROM for the LAN controller. (Default: Disabled)

This item is configurable only when **CSM Support** is set to **Enabled**.

☞ **Storage Boot Option Control**

Allows you to select whether to enable the UEFI or legacy option ROM for the storage device controller.

- ▶▶ Do not launch Disables option ROM.
- ▶▶ Legacy Enables legacy option ROM only.
- ▶▶ UEFI Enables UEFI option ROM only. (Default)

This item is configurable only when **CSM Support** is set to **Enabled**.

☞ **Other PCI devices**

Allows you to select whether to enable the UEFI or Legacy option ROM for the PCI device controller other than the LAN, storage device, and graphics controllers.

- ▶▶ Do not launch Disables option ROM.
- ▶▶ Legacy Enables legacy option ROM only.
- ▶▶ UEFI Enables UEFI option ROM only. (Default)

This item is configurable only when **CSM Support** is set to **Enabled**.

☞ **Administrator Password**

Allows you to configure an administrator password. Press <Enter> on this item, type the password, and then press <Enter>. You will be requested to confirm the password. Type the password again and press <Enter>. You must enter the administrator password (or user password) at system startup and when entering BIOS Setup. Differing from the user password, the administrator password allows you to make changes to all BIOS settings.

☞ **User Password**

Allows you to configure a user password. Press <Enter> on this item, type the password, and then press <Enter>. You will be requested to confirm the password. Type the password again and press <Enter>. You must enter the administrator password (or user password) at system startup and when entering BIOS Setup. However, the user password only allows you to make changes to certain BIOS settings but not all.

To cancel the password, press <Enter> on the password item and when requested for the password, enter the correct one first. When prompted for a new password, press <Enter> without entering any password. Press <Enter> again when prompted to confirm.

NOTE: Before setting the User Password, be sure to set the Administrator Password first.

2-6 Peripherals



Initial Display Output

Specifies the first initiation of the monitor display from the installed PCI Express graphics card.

- ▶▶ PCIe 1 Slot Sets the graphics card on the PCIEX16_1 slot as the first display. (Default)
- ▶▶ PCIe 2 Slot Sets the graphics card on the PCIEX4_1 slot as the first display.
- ▶▶ PCIe 3 Slot Sets the graphics card on the PCIEX16_2 slot as the first display.
- ▶▶ PCIe 4 Slot Sets the graphics card on the PCIEX4_2 slot as the first display.
- ▶▶ PCIe 5 Slot Sets the graphics card on the PCIEX8 slot as the first display.

EZ RAID

Allows you to quickly set up a RAID array. Refer to Chapter 3, "Configuring a RAID Set," for instructions on configuring a RAID array.

RGB Fusion

Allows you to set the LED lighting mode for the motherboard.

- ▶▶ Off Disables this function.
- ▶▶ Pulse Mode All LEDs simultaneously fade in and fade out.
- ▶▶ Color Cycle All LEDs simultaneously cycle through a full spectrum of colors.
- ▶▶ Static Mode All LEDs emit a single color. (Default)
- ▶▶ Flash Mode All LEDs simultaneously flash on and off.
- ▶▶ Double Flash All LEDs flash in an interlaced pattern.

LEDs in Sleep, Hibernation, and Soft Off States

Allows you to set the lighting mode of the motherboard LEDs in system S3/S4/S5 state. This feature is supported only with a 5V digital LED strip.

- ▶▶ Off Disables the selected lighting mode when the system enters S3/S4/S5 state. (Default)
- ▶▶ On Enables the selected lighting mode when the system enters S3/S4/S5 state.

Intel Platform Trust Technology (PTT)

Enables or disables Intel® PTT Technology. (Default: Disabled)

▶ **Trusted Computing**

Enables or disables Trusted Platform Module (TPM).

▶ **Network Stack Configuration**

☞ **Network Stack**

Disables or enables booting from the network to install a GPT format OS, such as installing the OS from the Windows Deployment Services server. (Default: Disabled)

☞ **Ipv4 PXE Support**

Enables or disables IPv4 PXE Support. This item is configurable only when **Network Stack** is enabled.

☞ **Ipv4 HTTP Support**

Enables or disables HTTP boot support for IPv4. This item is configurable only when **Network Stack** is enabled.

☞ **Ipv6 PXE Support**

Enables or disables IPv6 PXE Support. This item is configurable only when **Network Stack** is enabled.

☞ **Ipv6 HTTP Support**

Enables or disables HTTP boot support for IPv6. This item is configurable only when **Network Stack** is enabled.

☞ **IP6 Configuration Policy**

Allows you to change IP6 Configuration Policy to Automatic or Manual. This item is configurable only when **Network Stack** is enabled. (Default: Automatic)

☞ **PXE boot wait time**

Allows you to configure how long to wait before you can press <Esc> to abort the PXE boot. This item is configurable only when **Network Stack** is enabled. (Default: 0)

☞ **Media detect count**

Allows you to set the number of times to check the presence of media. This item is configurable only when **Network Stack** is enabled. (Default: 1)

▶ **USB Configuration**

☞ **Legacy USB Support**

Allows USB keyboard/mouse to be used in MS-DOS. (Default: Enabled)

☞ **XHCI Hand-off**

Determines whether to enable XHCI Hand-off feature for an operating system without XHCI Hand-off support. (Default: Disabled)

☞ **USB Mass Storage Driver Support**

Enables or disables support for USB storage devices. (Default: Enabled)

☞ **Port 60/64 Emulation**

Enables or disables emulation of I/O ports 64h and 60h. This should be enabled for full legacy support for USB keyboards/mice in MS-DOS or in operating system that does not natively support USB devices. (Default: Enabled)

☞ **Mass Storage Devices**

Displays a list of connected USB mass storage devices. This item appears only when a USB storage device is installed.

▶ **SATA And RST Configuration**

☞ **SATA Controller(s)**

Enables or disables the integrated SATA controllers. (Default: Enabled)

☞ **SATA Mode Selection**

Enables or disables RAID for the SATA controllers integrated in the Chipset or configures the SATA controllers to AHCI mode.

▶▶ Intel RST Premium With Intel Optane System Acceleration ^(Note) Enables RAID for the SATA controller.

▶▶ Intel RST Premium ^(Note) Enables RAID for the SATA controller.

▶▶ AHCI Configures the SATA controllers to AHCI mode. Advanced Host Controller Interface (AHCI) is an interface specification that allows the storage driver to enable advanced Serial ATA features such as Native Command Queuing and hot plug. (Default)

☞ **Aggressive LPM Support**

Enables or disables the power saving feature, ALPM (Aggressive Link Power Management), for the Chipset SATA controllers. (Default: Enabled)

☞ **Port 0/1/2/3/4/5/6/7**

Enables or disables each SATA port. (Default: Enabled)

☞ **Hot plug**

Enables or disable the hot plug capability for each SATA port. (Default: Disabled)

☞ **Configured as eSATA**

Enables or disables support for external SATA devices.

☞ **Mechanical Presence Switch**

Allows you to determine whether to turn on the Mechanical Presence switch for the SATA device. This item is configurable only when **Hot plug** is enabled. (Default: Enabled)

▶ **Intel(R) Ethernet Connection**

This sub-menu provides information on LAN configuration and related configuration options.

(Note) This item is present only when you install a CPU that supports this feature.

2-7 Chipset



- ☞ **VT-d** ^(Note)
Enables or disables Intel® Virtualization Technology for Directed I/O. (Default: Enabled)
- ☞ **Audio Controller**
Enables or disables the onboard audio function. (Default: Enabled)
If you wish to install a 3rd party add-in audio card instead of using the onboard audio, set this item to **Disabled**.
- ☞ **PCH LAN Controller**
Enables or disables the onboard LAN function. (Default: Enabled)
If you wish to install a 3rd party add-in network card instead of using the onboard LAN, set this item to **Disabled**.
- ☞ **Wake on LAN Enable**
Enables or disables the wake on LAN function. (Default: Enabled)

(Note) This item is present only when you install a CPU that supports this feature. For more information about Intel® CPUs' unique features, please visit Intel's website.

2-8 Power



Platform Power Management

Enables or disables the Active State Power Management function (ASPM). (Default: Disabled)

PEG ASPM

Allows you to configure the ASPM mode for the device connected to the CPU PEG bus. This item is configurable only when **Platform Power Management** is set to **Enabled**. (Default: Enabled)

PCH ASPM

Allows you to configure the ASPM mode for the device connected to Chipset's PCI Express bus. This item is configurable only when **Platform Power Management** is set to **Enabled**. (Default: Enabled)

DMI ASPM

Allows you to configure the ASPM mode for both CPU side and Chipset side of the DMI link. This item is configurable only when **Platform Power Management** is set to **Enabled**. (Default: Enabled)

AC BACK

Determines the state of the system after the return of power from an AC power loss.

- ▶▶ Always Off The system stays off upon the return of the AC power. (Default)
- ▶▶ Always On The system is turned on upon the return of the AC power.
- ▶▶ Memory The system returns to its last known awake state upon the return of the AC power.

Power On By Keyboard

Allows the system to be turned on by a PS/2 keyboard wake-up event.

Note: To use this function, you need an ATX power supply providing at least 1A on the +5VSB lead.

- ▶▶ Disabled Disables this function. (Default)
- ▶▶ Any Key Press any key to turn on the system.
- ▶▶ Keyboard 98 Press POWER button on the Windows 98 keyboard to turn on the system.
- ▶▶ Password Set a password with 1~5 characters to turn on the system.

☞ **Power On Password**

Set the password when **Power On By Keyboard** is set to **Password**.

Press <Enter> on this item and set a password with up to 5 characters and then press <Enter> to accept.

To turn on the system, enter the password and press <Enter>.

Note: To cancel the password, press <Enter> on this item. When prompted for the password, press <Enter> again without entering the password to clear the password settings.

☞ **Power On By Mouse**

Allows the system to be turned on by a PS/2 mouse wake-up event.

Note: To use this function, you need an ATX power supply providing at least 1A on the +5VSB lead.

- ▶▶ Disabled Disables this function. (Default)
- ▶▶ Move Move the mouse to turn on the system.
- ▶▶ Double Click Double click on left button on the mouse to turn on the system.

☞ **ErP**

Determines whether to let the system consume least power in S5 (shutdown) state. (Default: Disabled)

Note: When this item is set to **Enabled**, the following functions will become unavailable: Resume by Alarm, PME event wake up, power on by mouse, power on by keyboard, and wake on LAN.

☞ **Soft-Off by PWR-BTTN**

Configures the way to turn off the computer in MS-DOS mode using the power button.

- ▶▶ Instant-Off Press the power button and then the system will be turned off instantly. (Default)
- ▶▶ Delay 4 Sec. Press and hold the power button for 4 seconds to turn off the system. If the power button is pressed for less than 4 seconds, the system will enter suspend mode.

☞ **Power Loading**

Enables or disables dummy load. When the power supply is at low load, a self-protection will activate causing it to shutdown or fail. If this occurs, please set to **Enabled**. **Auto** lets the BIOS automatically configure this setting. (Default: Auto)

☞ **S3 Save Mode**

Allows you to determine whether to let the system enter power-saving mode in system S3 state. (Default: Disabled)

☞ **Resume by Alarm**

Determines whether to power on the system at a desired time. (Default: Disabled)

If enabled, set the date and time as following:

- ▶▶ Wake up day: Turn on the system at a specific time on each day or on a specific day in a month.
- ▶▶ Wake up hour/minute/second: Set the time at which the system will be powered on automatically.

Note: When using this function, avoid inadequate shutdown from the operating system or removal of the AC power, or the settings may not be effective.

2-9 Save & Exit



☞ Save & Exit Setup

Press <Enter> on this item and select **Yes**. This saves the changes to the CMOS and exits the BIOS Setup program. Select **No** or press <Esc> to return to the BIOS Setup Main Menu.

☞ Exit Without Saving

Press <Enter> on this item and select **Yes**. This exits the BIOS Setup without saving the changes made in BIOS Setup to the CMOS. Select **No** or press <Esc> to return to the BIOS Setup Main Menu.

☞ Load Optimized Defaults

Press <Enter> on this item and select **Yes** to load the optimal BIOS default settings. The BIOS default settings help the system to operate in optimum state. Always load the Optimized defaults after updating the BIOS or after clearing the CMOS values.

☞ Boot Override

Allows you to select a device to boot immediately. Press <Enter> on the device you select and select **Yes** to confirm. Your system will restart automatically and boot from that device.

☞ Save Profiles

This function allows you to save the current BIOS settings to a profile. You can create up to 8 profiles and save as Setup Profile 1~ Setup Profile 8. Press <Enter> to complete. Or you can select **Select File in HDD/FDD/USB** to save the profile to your storage device.

☞ Load Profiles

If your system becomes unstable and you have loaded the BIOS default settings, you can use this function to load the BIOS settings from a profile created before, without the hassles of reconfiguring the BIOS settings. First select the profile you wish to load and then press <Enter> to complete. You can select **Select File in HDD/FDD/USB** to input the profile previously created from your storage device or load the profile automatically created by the BIOS, such as reverting the BIOS settings to the last settings that worked properly (last known good record).

Chapter 3 Configuring a RAID Set

RAID Levels

	RAID 0	RAID 1	RAID 5	RAID 10
Minimum Number of Hard Drives	≥2	2	≥3	4
Array Capacity	Number of hard drives * Size of the smallest drive	Size of the smallest drive	(Number of hard drives - 1) * Size of the smallest drive	(Number of hard drives/2) * Size of the smallest drive
Fault Tolerance	No	Yes	Yes	Yes

To create a RAID set, follow the steps below:

- A. Install SATA hard drive(s) or SSDs in your computer.
- B. Configure SATA controller mode in BIOS Setup.
- C. Configure a RAID array in RAID BIOS. ^(Note 1)
- D. Install the RAID/AHCI driver and operating system.

Before you begin, please prepare the following items:

- At least two SATA hard drives or SSDs ^(Note 2) (to ensure optimal performance, it is recommended that you use two hard drives with identical model and capacity). ^(Note 3)
- A Windows setup disk.
- Motherboard driver disk.
- A USB thumb drive.

3-1 Configuring SATA Controllers

A. Installing hard drives

Install the hard drives/SSDs in the Intel® Chipset controlled connectors on the motherboard. Then connect the power connectors from your power supply to the hard drives.

(Note 1) Skip this step if you do not want to create RAID array on the SATA controller.

(Note 2) An M.2 PCIe SSD cannot be used to set up a RAID set either with an M.2 SATA SSD or a SATA hard drive.

(Note 3) Refer to "1-9 Internal Connectors," for the installation notices for the M.2 and SATA connectors.

B. Configuring SATA controller mode in BIOS Setup

Make sure to configure the SATA controller mode correctly in system BIOS Setup.

Step 1:

Turn on your computer and press <Delete> to enter BIOS Setup during the POST (Power-On Self-Test). Go to **Peripherals\SATA And RST Configuration**, make sure **SATA Controller(s)** is enabled. To create RAID, set **SATA Mode Selection** to **Intel RST Premium With Intel Optane System Acceleration** (Figure 1). Then save the settings and restart your computer.



Figure 1

Step 2:

To use the EZ RAID feature, follow the steps in "C-1." To configure UEFI RAID, follow the steps in "C-2." To enter the legacy RAID ROM, refer to "C-3" for more information. Finally, save the settings and exit BIOS Setup.



The BIOS Setup menus described in this section may differ from the exact settings for your motherboard. The actual BIOS Setup menu options you will see shall depend on the motherboard you have and the BIOS version.

C-1. Using EZ RAID

GIGABYTE motherboards provide you with the EZ RAID feature, allowing you to quickly configure a RAID array with simplified steps.

Step 1:

After restarting the computer, enter the BIOS Setup and go to **Peripherals**. Press <Enter> on the **EZ RAID** item. Select the type of hard drives you use for RAID in the **Type** tab and then press <Enter> (Figure 2).



Figure 2

Step 2:

Go to the **Mode** tab to select a RAID level. RAID levels supported include RAID 0, RAID 1, RAID 10, and RAID 5 (the selections available depend on the number of the hard drives being installed). Then press <Enter> to move to the **Create** tab. Click **Proceed** to begin (Figure 3).



Figure 3

After completing, you'll be brought back to the **Intel(R) Rapid Storage Technology** screen. Under **RAID Volumes** you can see the new RAID volume. To see more detailed information, press <Enter> on the volume to check for information on RAID level, stripe block size, array name, and array capacity, etc. (Figure 4).



Figure 4

Delete RAID Volume

To delete a RAID array, press <Enter> on the volume to be deleted on the **Intel(R) Rapid Storage Technology** screen. After entering the **RAID VOLUME INFO** screen, press <Enter> on **Delete** to enter the **Delete** screen. Press <Enter> on **Yes** (Figure 5).

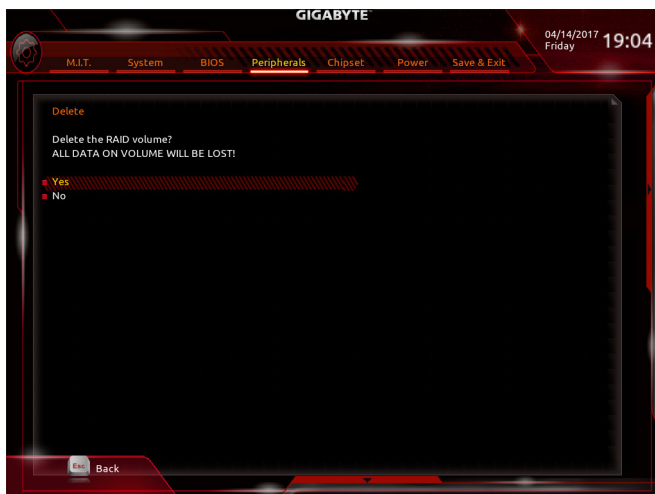

Figure 5

C-2. UEFI RAID Configuration

Step 1:

In BIOS Setup, go to **BIOS** and set **CSM Support** to **Disabled** (Figure 6). Save the changes and exit BIOS Setup.



Figure 6

Step 2:

After the system reboot, enter BIOS Setup again. Then enter the **Peripherals\Intel(R) Rapid Storage Technology** sub-menu (Figure 7).



Figure 7

Step 3:

On the **Intel(R) Rapid Storage Technology** menu, press <Enter> on **Create RAID Volume** to enter the **Create RAID Volume** screen. Enter a volume name with 1~16 letters (letters cannot be special characters) under the **Name** item and press <Enter>. Then, select a RAID level (Figure 8). RAID levels supported include RAID 0, RAID 1, RAID 10, and RAID 5 (the selections available depend on the number of the hard drives being installed). Next, use the down arrow key to move to **Select Disks**.



Figure 8

Step 4:

Under **Select Disks** item, select the hard drives to be included in the RAID array. Press the <Space> key on the hard drives to be selected (selected hard drives are marked with "X"). Then set the stripe block size (Figure 9). The stripe block size can be set from 4 KB to 128 KB. Once you have selected the stripe block size, set the volume capacity.



Figure 9

Step 5:

After setting the capacity, move to **Create Volume** and press <Enter> to begin. (Figure 10)



Figure 10

After completing, you'll be brought back to the **Intel(R) Rapid Storage Technology** screen. Under **RAID Volumes** you can see the new RAID volume. To see more detailed information, press <Enter> on the volume to check for information on RAID level, stripe block size, array name, and array capacity, etc. (Figure 11)



Figure 11

Delete RAID Volume

To delete a RAID array, press <Enter> on the volume to be deleted on the **Intel(R) Rapid Storage Technology** screen. After entering the **RAID VOLUME INFO** screen, press <Enter> on **Delete** to enter the **Delete** screen. Press <Enter> on **Yes** (Figure 12).



Figure 12

C-3. Configuring Legacy RAID ROM

Enter the Intel® legacy RAID BIOS setup utility to configure a RAID array. Skip this step and proceed with the installation of Windows operating system for a non-RAID configuration.

Step 1:

In BIOS Setup, go to **BIOS** and set **CSM Support** to **Enabled** and **Storage Boot Option Control** to **Legacy**. Save the changes and exit BIOS Setup. After the POST memory test begins and before the operating system boot begins, look for a message which says "Press <Ctrl-I> to enter Configuration Utility" (Figure 13). Press <Ctrl> + <I> to enter the RAID Configuration Utility.

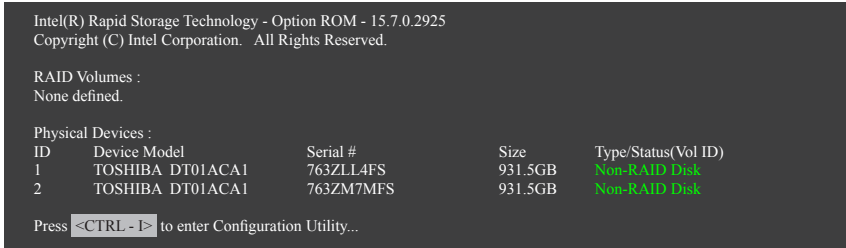

Figure 13

Step 2:

After you press <Ctrl> + <I>, the **MAIN MENU** screen will appear (Figure 14).

Create RAID Volume

If you want to create a RAID array, select **Create RAID Volume** in **MAIN MENU** and press <Enter>.

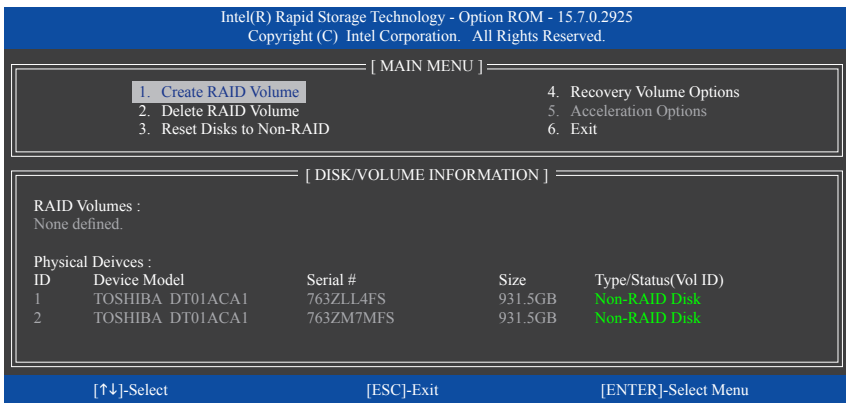

Figure 14

Step 3:

After entering the **CREATE VOLUME MENU** screen, enter a volume name with 1~16 letters (letters cannot be special characters) under the **Name** item and press <Enter>. Then, select a RAID level (Figure 15). RAID levels supported include RAID 0, RAID 1, RAID 10, and RAID 5 (the selections available depend on the number of the hard drives being installed). Press <Enter> to proceed.

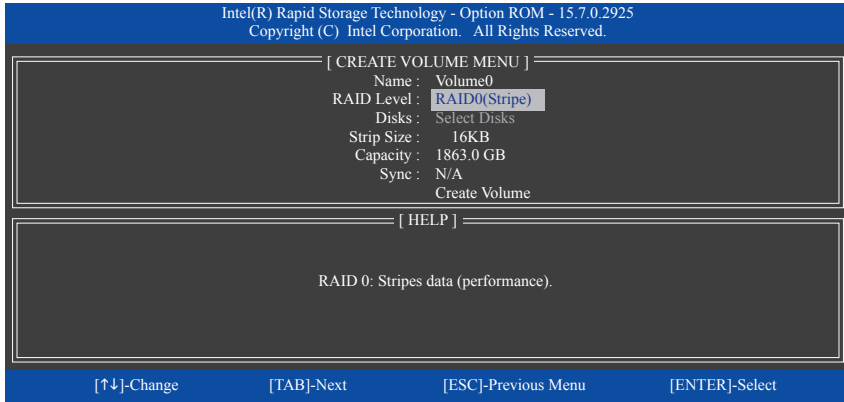

Figure 15

Step 4:

Under **Disks** item, select the hard drives to be included in the RAID array. If only two hard drives are installed, they will be automatically assigned to the array. Set the stripe block size (Figure 16) if necessary. The stripe block size can be set from 4 KB to 128 KB. Once you have selected the stripe block size, press <Enter>.

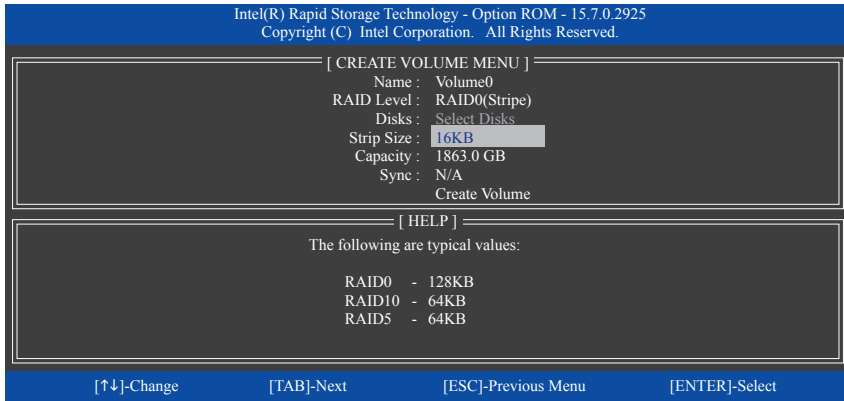

Figure 16

Step 5:

Enter the array capacity and press <Enter>. Finally press <Enter> on the **Create Volume** item to begin creating the RAID array. When prompted to confirm whether to create this volume, press <Y> to confirm or <N> to cancel (Figure 17).

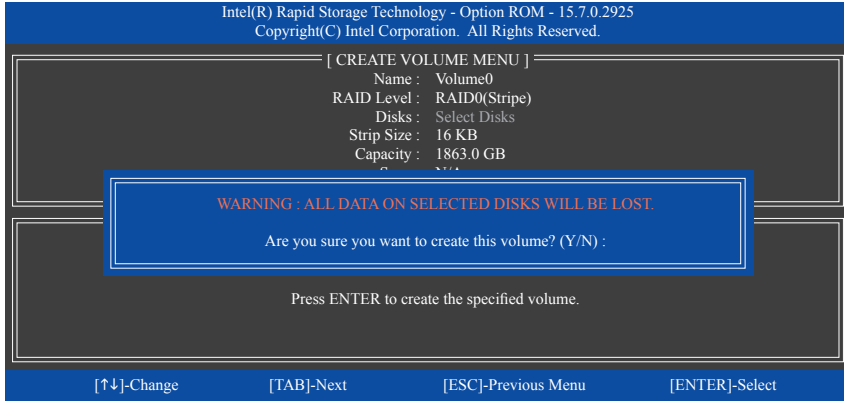

Figure 17

When completed, you can see detailed information about the RAID array in the **DISK/VOLUME INFORMATION** section, including the RAID level, stripe block size, array name, and array capacity, etc. (Figure 18)

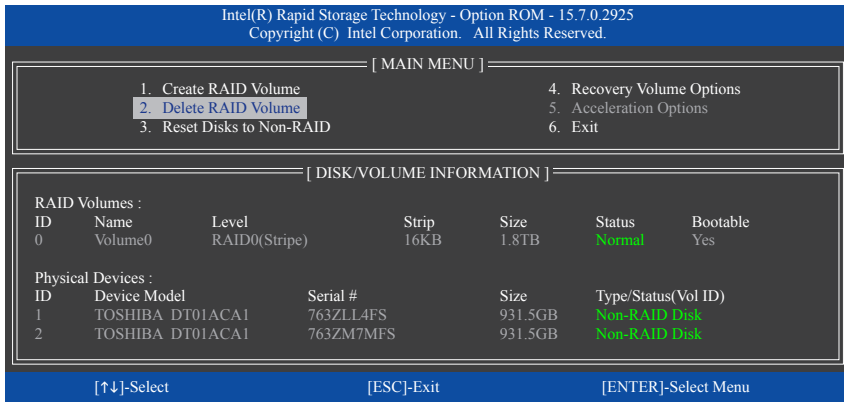

Figure 18

To exit the RAID BIOS utility, press <Esc> or select **6. Exit** in **MAIN MENU**.

Now, you can proceed to install the SATA RAID/AHCI driver and operating system.

Recovery Volume Options

Intel® Rapid Recover Technology provides data protection by allowing users to easily restore data and system operation using a designated recovery drive. With the Rapid Recovery Technology, which employs RAID 1 functionality, users can copy the data from the master drive to the recovery drive; if needed, the data on the recovery drive can be restored back to the master drive.

Before you begin:

- The recovery drive must have equal or greater capacity than the master drive.
- A recovery volume can be created with two hard drives only. A recovery volume and a RAID array cannot co-exist in the system at the same time, that is, if you have already created a recovery volume, you are unable to create a RAID array.
- By default, only the master drive can be viewed in the operating system; the recovery drive is hidden.

Step 1:

Select **Create RAID Volume** in **MAIN MENU** and press <Enter> (Figure 19).

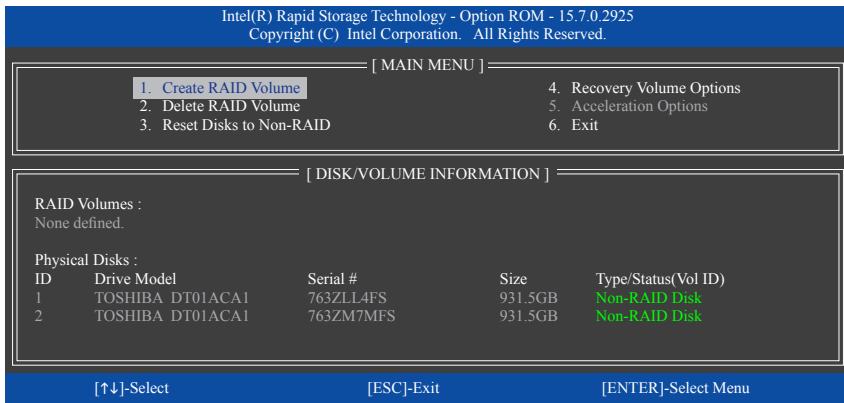

Figure 19

Step 2:

After entering the volume name, select **Recovery** under the **RAID Level** item and press <Enter> (Figure 20).

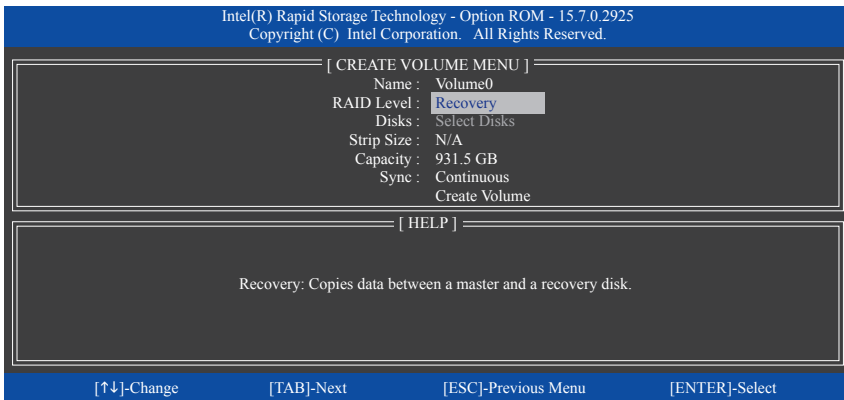

Figure 20

Step 3:

Press <Enter> under the **Select Disks** item. In the **SELECT DISKS** box, press <Tab> on the hard drive you want to use for the master drive and press <Space> on the hard drive you want to use for the recovery drive. (Make sure the recovery drive has equal or larger capacity than the master drive.) Then press <Enter> to confirm (Figure 21).

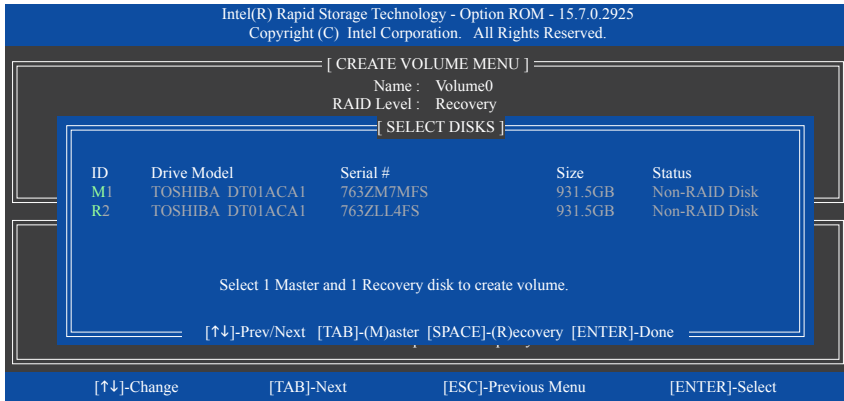

Figure 21

Step 4:

Under **Sync**, select **Continuous** or **On Request** (Figure 22). When set to **Continuous**, changes made to the data on the master drive will be automatically and continuously copied to the recovery drive when both hard drives are installed in the system. **On Request** allows users to update data from the master drive to the recovery drive manually using the Intel® Rapid Storage Technology utility in the operating system. **On Request** also allows users to restore the master drive to a previous state.

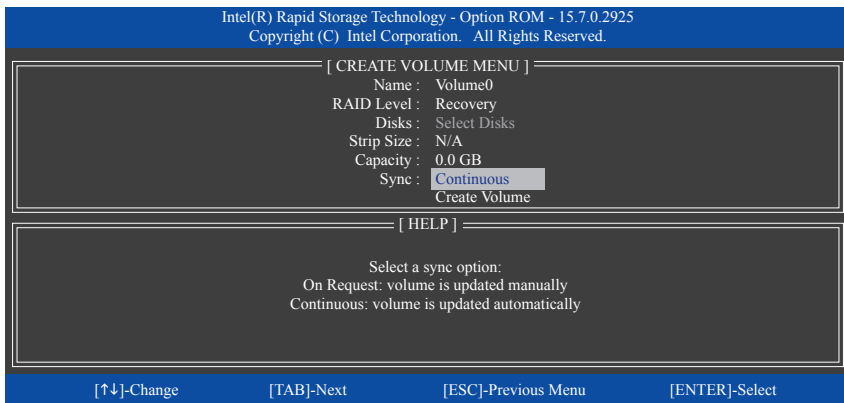

Figure 22

Step 5:

Finally press <Enter> on the **Create Volume** item to begin creating the Recovery Volume and follow the on-screen instructions to complete.

3-2 Installing the RAID/AHCI Driver and Operating System

With the correct BIOS settings, you are ready to install the operating system.

A. Installing Windows

As some operating systems already include Intel® RAID/AHCI driver, you do not need to install separate RAID/AHCI driver during the Windows installation process. After the operating system is installed, we recommend that you install all required drivers from the motherboard driver disk using "Xpress Install" to ensure system performance and compatibility. If the operating system to be installed requires that you provide additional SATA RAID/AHCI driver during the OS installation process, please refer to the steps below:

Step 1:

Copy the **IRST** folder under **Boot** in the driver disk to your USB thumb drive.

Step 2:

Boot from the Windows setup disk and perform standard OS installation steps. When the screen requesting you to load the driver appears, select **Browse**.

Step 3:

Insert the USB thumb drive and then browse to the location of the driver. The location of the driver is as follows:
\\IRST\6f1py-x64

Step 4:

When a screen as shown in Figure 1 appears, select **Intel Chipset SATA RAID Controller (D:\IRST\6f1py-x64\iSataAC.inf)** and click **Next** to load the driver and continue the OS installation.

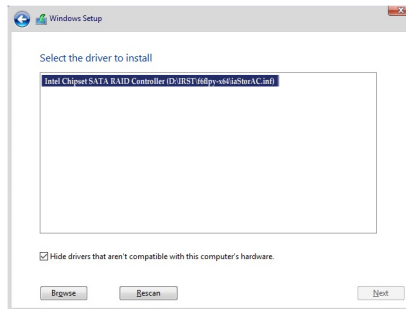

Figure 1

B. Rebuilding an Array

Rebuilding is the process of restoring data to a hard drive from other drives in the array. Rebuilding applies only to fault-tolerant arrays such as RAID 1, RAID 5 or RAID 10 arrays. The procedures below assume a new drive is added to replace a failed drive to rebuild a RAID 1 array. (Note: The new drive must have equal or greater capacity than the old one.)

Turn off your computer and replace the failed hard drive with a new one. Restart your computer.

- **Performing the Rebuild in the Operating System**

While in the operating system, make sure the chipset driver has been installed from the motherboard driver disk. Then launch the Intel® Rapid Storage Technology utility from the Start menu.

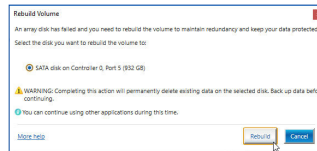
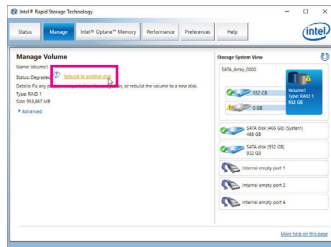

Step 2:

Select a new drive to rebuild the RAID and click **Rebuild**.

Step 1:

Go to the **Manage** menu and click **Rebuild to another disk** in **Manage Volume**.

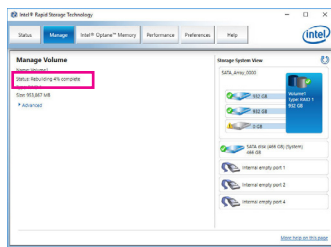

The **Status** item on the left of the screen displays the rebuild progress. After the RAID 1 volume rebuilding, the **Status** will display as **Normal**.

- **Restoring the Master Drive to a Previous State (for Recovery Volume only)**

When two hard drives are set to Recovery Volume in Update on Request mode, you can restore the master drive data to the last backup state when needed. For example, in case the master drive detects a virus, you can restore the recovery drive data to the master drive.

Step 1:

Select **4. Recovery Volume Options** in the **MAIN MENU** of the Intel® RAID Configuration Utility. On the **RECOVERY VOLUMES OPTIONS** menu, select **Enable Only Recovery Disk** to show the recovery drive in the operating system. Follow the on-screen instructions to complete and exit the RAID Configuration Utility.

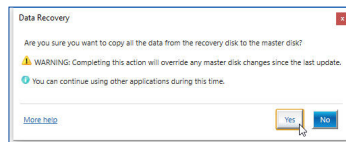
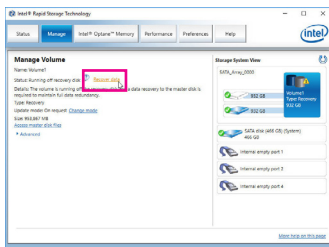
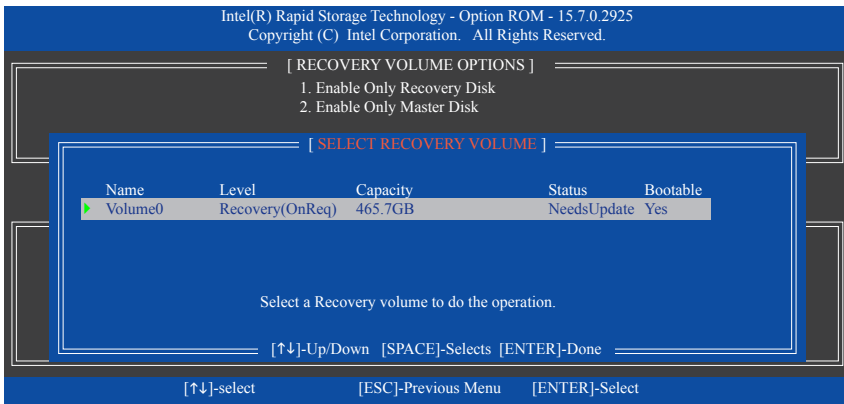

Step 3:

Click **Yes** to begin the data recovery.

Step 2:

Go to the **Manage** menu of the Intel® Rapid Storage Technology utility and click **Recover data** in **Manage Volume**.

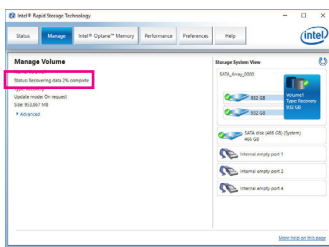

The **Status** item on the left of the screen displays the recovering status. After the recovery volume is completed, the **Status** will display as **Normal**.

3-3 Installing an Intel® Optane™ Memory

A. System Requirements

1. Intel® Optane™ memory
2. The Optane™ memory must have at least 16 GB capacity, and it must have equal or smaller capacity than the hard drive/SSD to be accelerated.
3. The Optane™ memory cannot be used to accelerate an existing RAID array; the accelerated hard drive/SSD cannot be included in a RAID array.
4. The hard drive/SSD to be accelerated must be a SATA hard drive or M.2 SATA SSD and must have Windows 10 64-bit (or later version) installed on it. (Must be formatted for GPT partition.)
5. The motherboard driver disk

B. Installation Guidelines

B-1: Installation in AHCI mode

If the SATA controller has been configured in AHCI mode, please install the Optane™ memory in the M2P_32G or M2Q_32G connector and follow the steps below:

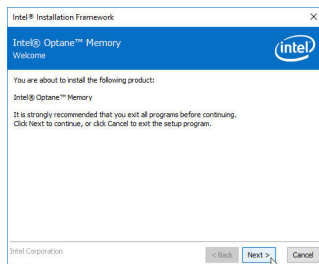

Step 1:

After entering the operating system, insert the motherboard driver disk into your optical drive. On the Xpress Install screen, select **Intel(R) Optane(TM) Memory System Acceleration** (Note) to install. Follow the on-screen instructions to continue. The system will auto-restart.

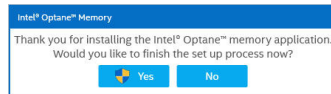

Step 2:

After re-entering the operating system, the dialog box as shown above will appear. Click **Yes** to continue the installation and then restart the system.

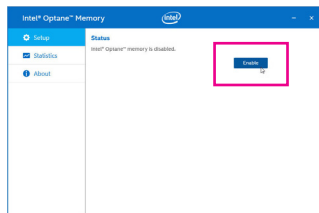

Step 3:

Launch the Intel(R) Optane Memory application from the Start menu. A message which says Intel® Optane™ Memory is disabled will appear on the main screen. Click **Enable** to activate the Intel® Optane™ Memory and restart the system again. (If you install more than one Optane™ memory, please select which one you are going to use).

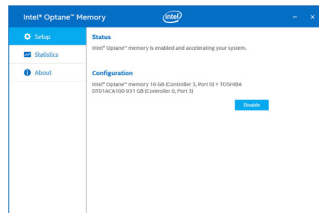

Step 4:

Launch the Intel(R) Optane Memory application from the Start menu and make sure the Intel® Optane™ Memory has been enabled. (The SATA controller mode is changed to Intel RST Premium With Intel Optane System Acceleration from AHCI mode. DO NOT change your SATA controller mode back to AHCI. Doing so will prevent Intel® Optane™ memory from functioning properly.)

(Note) If the system already has Intel® Rapid Storage Technology utility installed, you have to remove it first before installing the Intel(R) Optane Memory application.

B-2: Installation in Intel RST Premium With Intel Optane System Acceleration mode

If the SATA controller has been configured in Intel RST Premium With Intel Optane System Acceleration mode, please install the Optane™ memory in the M2P_32G or M2Q_32G connector first and follow the steps below:



Step 1:
After system restarts, go to the BIOS Setup, make sure **CSM Support** under the BIOS menu is disabled.



Step 2:
Go to **Peripherals\SATA And RST Configuration** and make sure **USE RST Legacy ROM** is disabled. If you want to enable the Optane™ memory installed in the M2P_32G connector, set **PCIe Storage Device on Port 9** to **RST Controlled**; to enable the Optane™ memory installed in the M2Q_32G connector, set **PCIe Storage Device on Port 17** to **RST Controlled**.

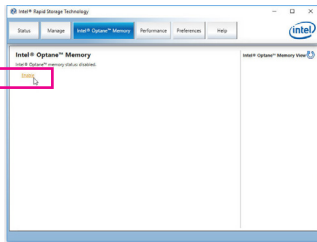

Step 3:
Enter the operating system, launch the Intel® Rapid Storage Technology utility from the Start menu, and then enable Intel® Optane™ Memory on the **Intel® Optane™ Memory** screen.

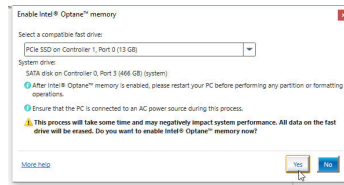

Step 4:
If you install more than one Optane™ memory, please select which one you are going to use.

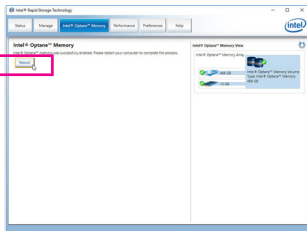

Step 5:
Follow the on-screen instruction to continue the installation and then restart the system when completed.



- An Optane™ memory cannot be used to accelerate an M.2 PCIe SSD.
- Do not abruptly remove the Optane™ memory. Doing so will cause the operating system to stop functioning correctly.
- If you want to change/remove the Optane™ memory, you must disable it using the Intel® Rapid Storage Technology or Intel(R) Optane™ Memory application first.
- After enabling the Optane™ memory, the related BIOS settings will remain even after a BIOS update.

Chapter 4 Drivers Installation



- Before installing the drivers, first install the operating system.
- After installing the operating system, insert the motherboard driver disk into your optical drive. Click on the message "Tap to choose what happens with this disc" on the top-right corner of the screen and select "Run Run.exe." (Or go to My Computer, double-click the optical drive and execute the Run.exe program.)

4-1 Drivers & Software

"Xpress Install" will automatically scan your system and then list all of the drivers that are recommended to install. You can click the **Xpress Install** button and "Xpress Install" will install all of the selected drivers. Or click the arrow  to individually install the drivers you need.

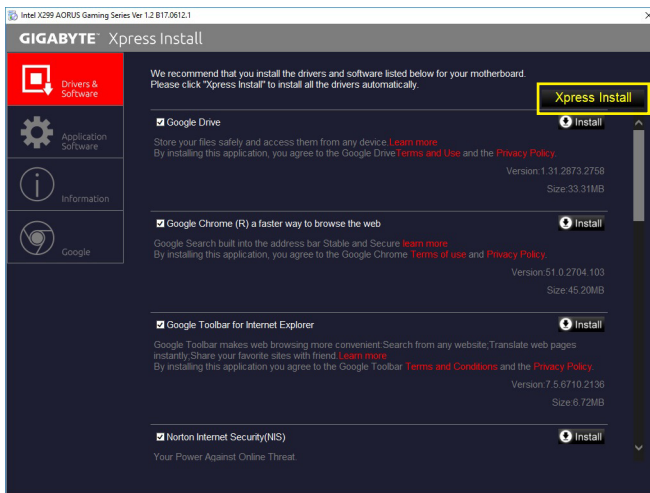

- Please ignore the popup dialog box(es) (e.g. the **Found New Hardware Wizard**) displayed when "Xpress Install" is installing the drivers. Failure to do so may affect the driver installation.
- Some device drivers will restart your system automatically during the driver installation. After the system restart, "Xpress Install" will continue to install other drivers.

4-2 Application Software

This page displays the apps that GIGABYTE develops and some free software. You can select the apps you want and click the **Install**  icon to begin the installation.

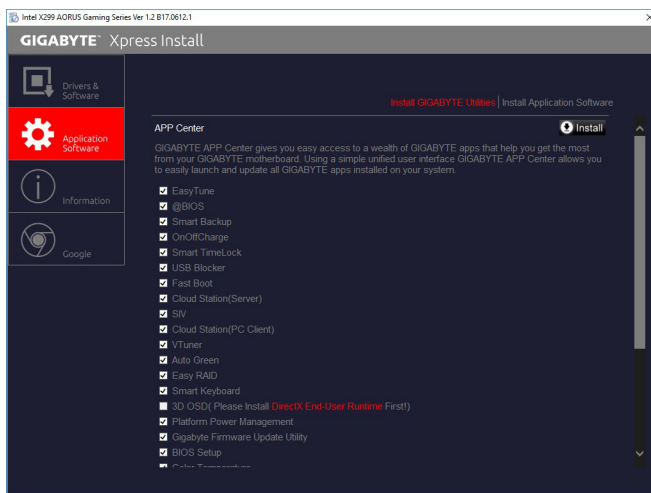

4-3 Information

This page provides detailed information on the drivers on the driver disk. The **Contact** page provides contact information of the GIGABYTE Taiwan headquarter. You can click the URL on this page to link to the GIGABYTE website to check more information on the GIGABYTE headquarter or worldwide branch offices.

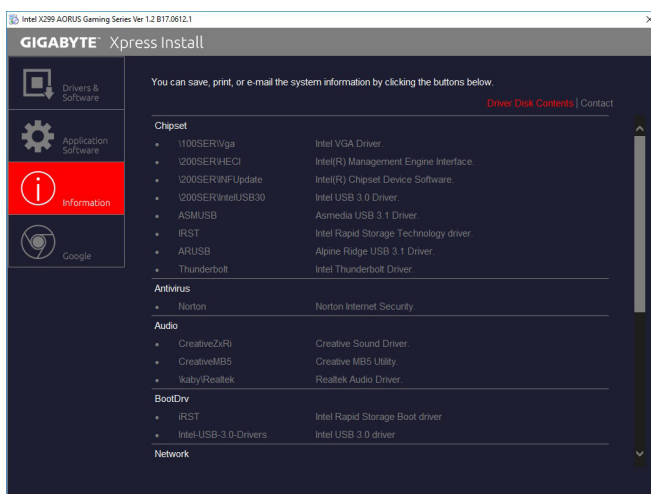

Chapter 5 Unique Features

5-1 BIOS Update Utilities

GIGABYTE motherboards provide two unique BIOS update tools, Q-Flash™ and @BIOS™. GIGABYTE Q-Flash and @BIOS are easy-to-use and allow you to update the BIOS without the need to enter MS-DOS mode. Additionally, this motherboard features the DualBIOS™ design, providing multiple protection for the safety and stability of your computer.

What is DualBIOS™?

Motherboards that support DualBIOS have two BIOS onboard, a main BIOS and a backup BIOS. Normally, the system works on the main BIOS. However, if the main BIOS is corrupted or damaged, the backup BIOS will take over on the next system boot to ensure normal system operation. For the sake of system safety, users cannot update the backup BIOS manually.

What is Q-Flash™?

With Q-Flash you can update the system BIOS without having to enter operating systems like MS-DOS or Windows first. Embedded in the BIOS, the Q-Flash tool frees you from the hassles of going through complicated BIOS flashing process.

What is @BIOS™?

@BIOS allows you to update the system BIOS while in the Windows environment. @BIOS will download the latest BIOS file from the nearest @BIOS server site and update the BIOS.

5-1-1 Updating the BIOS with the Q-Flash Utility

A. Before You Begin

1. From GIGABYTE's website, download the latest compressed BIOS update file that matches your motherboard model.
2. Extract the file and save the new BIOS file (e.g. X299AORUSUltraGaming.F1) to your USB flash drive, or hard drive. Note: The USB flash drive or hard drive must use FAT32/16/12 file system.
3. Restart the system. During the POST, press the <End> key to enter Q-Flash. Note: You can access Q-Flash by either pressing the <End> key during the POST or click the **Q-Flash** icon (or press the <F8> key) in BIOS Setup. However, if the BIOS update file is saved to a hard drive in RAID/AHCI mode or a hard drive attached to an independent SATA controller, use the <End> key during the POST to access Q-Flash.



Because BIOS flashing is potentially risky, please do it with caution. Inadequate BIOS flashing may result in system malfunction.



Select **Q-Flash** to access Q-Flash

B. Updating the BIOS

In the main menu of Q-Flash, use the keyboard or mouse to select an item to execute. When updating the BIOS, choose the location where the BIOS file is saved. The following procedure assumes that you have saved the BIOS file to a USB flash drive.

Step 1:

1. Insert the USB flash drive containing the BIOS file into the computer. In the main screen of Q-Flash, select **Update BIOS**.



- The **Save BIOS** option allows you to save the current BIOS file.
- Q-Flash only supports USB flash drive or hard drives using FAT32/16/12 file system.
- If the BIOS update file is saved to a hard drive in RAID/AHCI mode or a hard drive attached to an independent SATA controller, use the <End> key during the POST to access Q-Flash.

2. Select the BIOS update file.



Make sure the BIOS update file matches your motherboard model.

Step 2:

The screen will show that the BIOS file is being read from your USB flash drive. Please select **Fast** or **Intact** to begin the BIOS update. The screen will then display the update process.



- Do not turn off or restart the system when the system is reading/updating the BIOS.
- Do not remove the USB flash drive or hard drive when the system is updating the BIOS.

Step 3:

The system will restart after the update process is complete.

Step 4:

During the POST, press <Delete> to enter BIOS Setup. Select **Load Optimized Defaults** on the **Save & Exit** screen and press <Enter> to load BIOS defaults. System will re-detect all peripheral devices after a BIOS update, so we recommend that you reload BIOS defaults.



Select **Yes** to load BIOS defaults

Step 5:

Select **Save & Exit Setup** and press <Enter>. And then select **Yes** to save settings to CMOS and exit BIOS Setup. The procedure is complete after the system restarts.

5-1-2 Updating the BIOS with the @BIOS Utility

A. Before You Begin

1. In Windows, close all applications and TSR (Terminate and Stay Resident) programs. This helps prevent unexpected failures when performing a BIOS update.
2. If the BIOS is being updated via the Internet, ensure the Internet connection is stable and do NOT interrupt the Internet connection (for example, avoid a power loss or switching off the Internet). Failure to do so may result in a corrupted BIOS or a system that is unable to start.
3. GIGABYTE product warranty does not cover any BIOS damage or system failure resulting from an inadequate BIOS flashing.

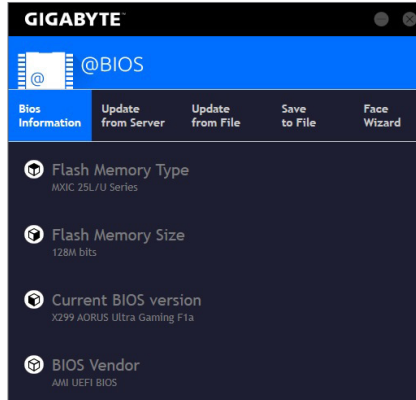

B. Using @BIOS

1. Update the BIOS Using the Internet Update Function:

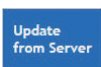

Click **Update from Server**, select the @BIOS server site closest to your location and then download the BIOS file that matches your motherboard model. Follow the on-screen instructions to complete.



If the BIOS update file for your motherboard is not present on the @BIOS server site, please manually download the BIOS update file from GIGABYTE's website and follow the instructions in "Update the BIOS without Using the Internet Update Function" below.

2. Update the BIOS without Using the Internet Update Function:

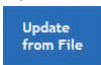

Click **Update from File**, then select the location where you save the BIOS update file obtained from the Internet or through other source. Follow the on-screen instructions to complete.

3. Save the Current BIOS File:



Click **Save to File** to save the current BIOS file.

4. Change the Boot-up Logo:

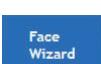

Click **Upload new image** in Face-Wizard and you will be able to change the boot-up logo with your own picture, creating a personalized boot-up screen. Click **Backup current image** to save the current boot-up logo.



Supported image formats include jpg, bmp, and gif.

C. After Updating the BIOS

Restart your system after updating the BIOS.



- Make sure that the BIOS file to be flashed matches your motherboard model. Updating the BIOS with an incorrect BIOS file could cause your system not to boot.
- Do not turn off the system or remove the power during the BIOS update process, or the BIOS may corrupt and the system may not boot.

5-2 APP Center

GIGABYTE App Center gives you easy access to a wealth of GIGABYTE apps that help you get the most from your GIGABYTE motherboard (Note). Using a simple, unified user interface, GIGABYTE App Center allows you to easily launch all GIGABYTE apps installed on your system, check related updates online, and download the apps, drivers, and BIOS.

Running the APP Center

Insert the motherboard driver disk. On the Autorun screen, go to **Application Software** Install GIGABYTE Utilities to install GIGABYTE App Center and the selected apps. Restart your computer after the installation is complete. In Desktop mode, click the App Center icon  in the notification area to launch the App Center utility (Figure 1). On the main menu, you can select an app to run or click **LiveUpdate** to update an app online.

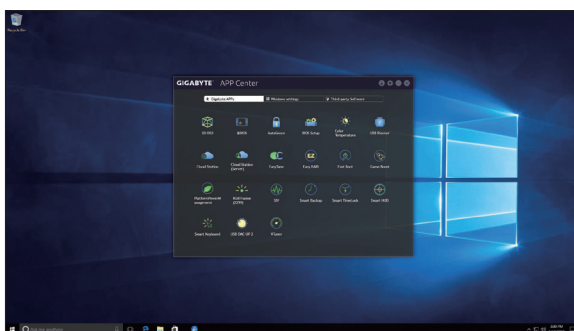

Figure 1

If the App Center is closed, you can restart it by clicking **Launch App Center** on the Start menu (Figure 2).



Figure 2

(Note) Available applications in APP Center may differ by motherboard model. Supported functions of each application may also vary depending on motherboard specifications.

5-2-1 3D OSD

3D OSD ^(Note) automatically detects and displays your system information during games, allowing you to easily get hold of your system information without switching between screens.

The 3D OSD Interface

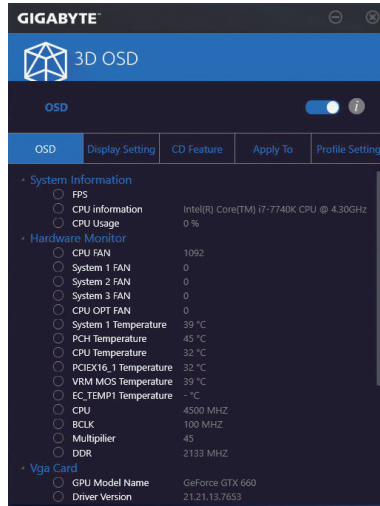

Using 3D OSD

Main Menu:

Allows you to enable or disable the 3D OSD feature and to select the type of real-time system information you wish to display. 3D OSD will detect and display a list of available options.

Configuration Menu:

Allows you to set a hotkey for enabling /disabling 3D OSD and specify the font size/location/color of the displayed information.

(Note) Please ensure that DirectX End-User Runtime has been installed on your system prior to installing 3D OSD.

5-2-2 AutoGreen

AutoGreen^(Note) is an easy-to-use tool that provides users with simple options to enable system power savings via a Bluetooth-enabled smart phone/tablet device. When the device is out of the range of the computer's Bluetooth receiver, the system will enter the specified power saving mode. Before using this app, you need to turn on Bluetooth on both your computer and smart phone/tablet device.

The AutoGreen Interface

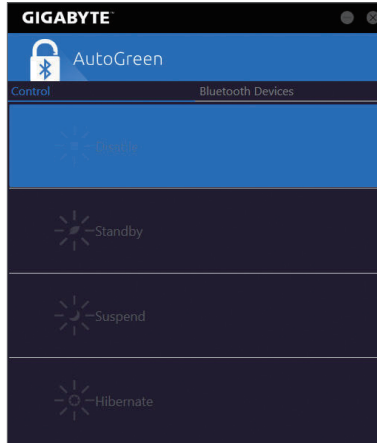

Control Tab:

The **Control** tab allows you to select a system power saving mode.

Button	Description
Disable	Disables this function
Standby	Enters Power on Suspend mode
Suspend	Enters Suspend to RAM mode
Hibernate	Enters Suspend to Disk mode

Bluetooth Devices Tab:

The **Bluetooth** tab allows you to pair your smart phone/tablet device with the Bluetooth receiver on your computer. Press **Refresh** to let AutoGreen search for the Bluetooth devices around you. A message will appear on both your computer and smart phone/tablet device prompting you to compare the passcodes on the two devices. Confirm to complete the pairing process.

(Note) Once your smart phone/tablet device has been paired with your AutoGreen-enabled computer, you'll not be able to use it to connect to other Bluetooth device(s).

5-2-3 BIOS Setup

This app provides information on your motherboard model and BIOS version. You can also use it to select the default language used by the BIOS and set the system time/power management settings.

The BIOS Setup Interface

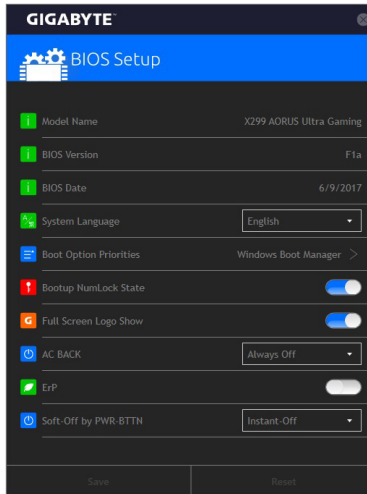

Using BIOS Setup:

- **System Language:**
Allows you to select the default language used by the BIOS.
- **Boot Option Priorities:**
Allows you to specify the overall boot order from the available devices.
- **Bootup NumLock State:**
Allows you to enable or disable Numlock feature on the numeric keypad of the keyboard after the POST.
- **Full Screen LOGO Show:**
Allows you to determine whether to display the GIGABYTE Logo at system startup.
- **AC BACK:**
Determines the state of the system after the return of power from an AC power loss.

Button	Description
Memory	The system returns to its last known awake state upon the return of the AC power.
Always On	The system is turned on upon the return of the AC power.
Always Off	The system stays off upon the return of the AC power.

- **ErP:**
Allows you to determine whether to let the system consume least power in S5 (shutdown) state.
- **Soft-Off by PWR-BTTN:**
Allows you to configure the way to turn off the computer in MS-DOS mode using the power button.

Button	Description
Instant-Off	Press the power button and then the system will be turned off instantly.
Delay 4 Sec.	Press and hold the power button for 4 seconds to turn off the system. If the power button is pressed for less than 4 seconds, the system will enter suspend mode.

After you configure the settings, click **Save** and restart the system. If you click the **Reset** button, the system will load the optimal BIOS default settings.

5-2-4 Color Temperature

GIGABYTE Color Temperature is a simple interface which allows you to directly adjust the monitor color temperature and reduce the blue light to protect your eyes.

The Color Temperature Interface

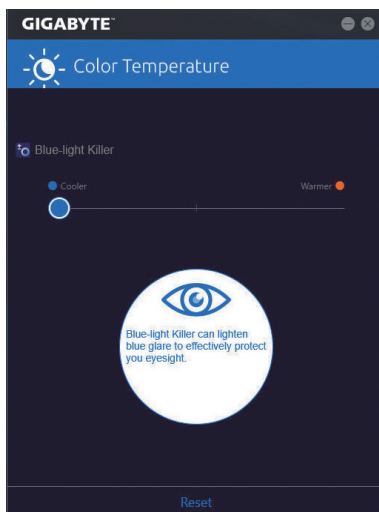

Using Color Temperature

You can use the slider for adjustment. To close the app, click the  icon on the top right corner. Clicking the **Reset** button reverts to the default settings.

5-2-5 Cloud Station

GIGABYTE Cloud Station (Server) is composed of HomeCloud, GIGABYTE Remote, Remote OC, and HotSpot, which allow your smart phone, tablet device, and remote computer to communicate, share resources, and control the host computer via wireless connection. Cloud Station allows your computer to share files with another computer that has Cloud Station (Server) installed.

Before You Begin:

- To use HomeCloud, GIGABYTE Remote, and Remote OC, you must install GIGABYTE Cloud Station on your smart phone/tablet device. (For Android systems, please download the app from Google Play; for iOS systems, please download it from App Store.)^(Note 1)
- To share HomeCloud files between computers, you need to install Cloud Station (Server) on the host computer and Cloud Station on the remote computer.
- Your smart phone/tablet device must have Android 4.0/iOS 6.0 or above version.
- The first time you use HomeCloud, GIGABYTE Remote, and Remote OC, you must sign in with your Google/Facebook/Windows Live account. Be sure to use the same account to sign in on your smart phone/tablet device and computers.

HomeCloud

HomeCloud allows you to upload/download/back up files^(Note 2) from your smart phone/tablet device/computer to the host computer.

The HomeCloud Interface

Cloud Station (Server):

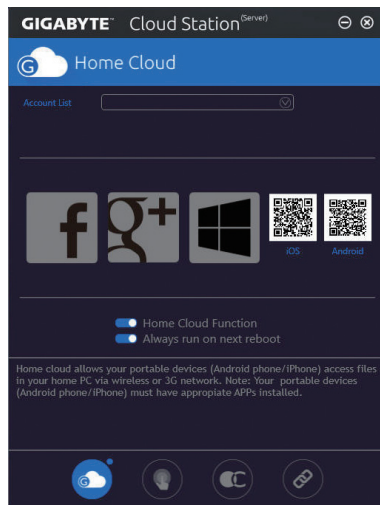

(Note 1) You can use your smart phone/tablet device to scan the QR code on the HomeCloud UI to link to the download page of the GIGABYTE Cloud Station on App Store or Google Play.

(Note 2) For iOS systems, the file types are limited to image/video files.

Cloud Station:

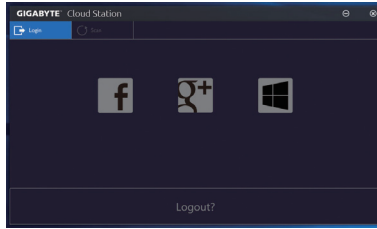

Using HomeCloud

Step 1:

Launch HomeCloud on the host computer (installed with Cloud Station (Server)), sign in with your Google/Facebook/Windows Live account or select the account on the **Account List**. Then enable **HomeCloud Function**. To automatically enable this function after system reboot, enable **Always run on next reboot**.

Step 2:

Run Cloud Station on your smart phone/tablet device/remote computer, sign in with the same account you use for HomeCloud on your host computer. Tap on **HomeCloud** to perform the following functions:

On the Host Computer:

Option	Function
Account List	Displays currently signed in account(s).
Remove	Remove the selected account.
Share Folder	Displays the shared folder directory of the currently signed in account.
Open Folder	Access the shared folder of the currently signed in account.

On the Smart Phone/Tablet Device/Remote Computer:

Option	Function
All Picture Files	File Upload: Tap on the folder, browse and select the files inside. Tap on the menu icon and select Upload selected Files to upload the files to your computer. File Download: Tap on the folder and then tap on the menu icon, select Download Files . You can browse the files and select the files that you want to download to your smart phone/tablet device.
All Music Files	
All Video Files	
All Files	
User Contacts	Tap on the folder and then tap on the menu icon to use the options including Backup to remote, Restore From remote, View Remote Contact, and Reselect Computers .
Call Log	

GIGABYTE Remote

GIGABYTE Remote allows you to use your smart phone/tablet device to remotely control the mouse/keyboard/Windows Media Player on your computer.

The GIGABYTE Remote Interface

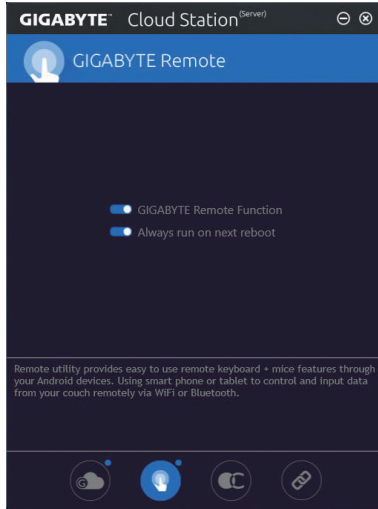

Using GIGABYTE Remote

Step 1:

On the host computer, launch GIGABYTE Remote and enable **GIGABYTE Remote Function**. To automatically enable this function after system reboot, enable **Always run on next reboot**.

Step 2:

Run GIGABYTE Cloud Station on your smart phone/tablet device, sign in with the same account you use for HomeCloud on your computer. Tap on **Remote Control** to perform the following remote controls:

On the Smart Phone/Tablet Device:

Option	Function
Mouse	Remotely perform mouse functionalities including dragging, right/left-clicking, and holding the mouse left button.
Keyboard	Remotely control your keyboard such as text input (tap on Real-Time Mode to type texts) or deletion.
Media	Remotely configure and control the currently running Windows Media Player application on your computer.

Remote OC

Remote OC provides you with remote control options including overclocking and system tweaking, system monitoring plus the ability to also remotely power down/reset the PC when needed.

The Remote OC Interface

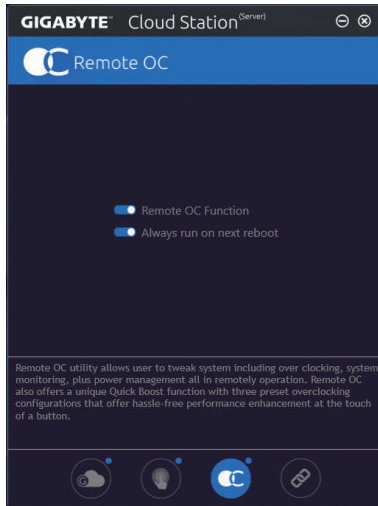

Using Remote OC

Step 1:

On the host computer, launch Remote OC and enable **Remote OC Function**. To automatically enable this function after system reboot, enable **Always run on next reboot**.

Step 2:

Run GIGABYTE Cloud Station on your smart phone/tablet device, sign in with the same account you use for HomeCloud on your computer. Tap on **Remote OC** to perform the following functions:

On the Smart Phone/Tablet Device:

Option	Function
Tuner	Allows you to change CPU/memory frequency and voltage settings.
INFO	Displays the system information, including the CPU, motherboard, and memory.
HW MONIT	Allows you to monitor system temperatures, voltages, and fan speeds.
QUICK BOOST	Provides you with three preset overclocking configurations.
CONTROL	Allows you to remotely reboot or shut down your computer.

HotSpot

HotSpot turns your computer into a virtual wireless access point and allows you to share your connection with your other wireless devices. Make sure your computer has been connected to a network and Wi-Fi is enabled.

The HotSpot Interface

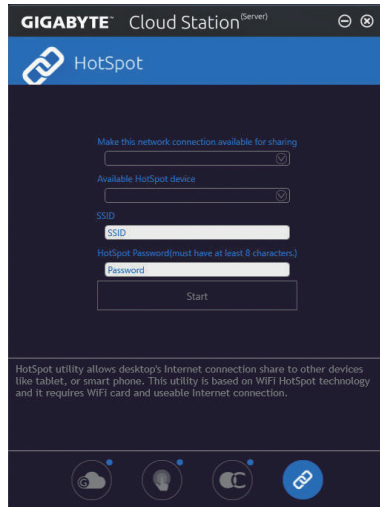

Using HotSpot:

Configuring your host computer:

The options are as follows. Make sure to click **Start** to complete.

- **Make this network connection available for sharing:**
Select a currently running network connection you want to share.
- **Available HotSpot device:**
Select a network virtual adapter. If there are more than one Wi-Fi card on your computer, you need to select the one you want to use from the list.
- **SSID:**
The hotspot SSID name. You can keep the default name or create your own one.
- **HotSpot Password(must have at least 8 characters):**
The password is required when other wireless devices want to access the Internet through the virtual wireless access point. You can keep the default name or create your own one. The password must have at least 8 characters and cannot be empty.

Sharing your connection with other wireless devices:

First make sure Wi-Fi is enabled on the wireless devices. Then browse to the network configuration screen, search for available Wi-Fi networks, and tap the name of your virtual wireless access point, enter the password, and confirm.



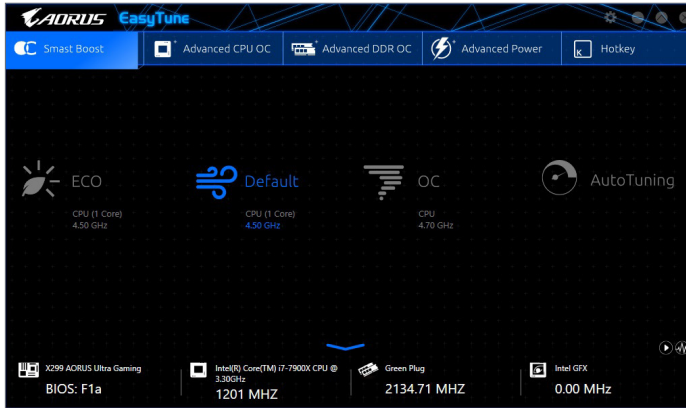

5-2-6 EasyTune

GIGABYTE's EasyTune is a simple and easy-to-use interface that allows users to fine-tune their system settings or do overclock/overvoltage in Windows environment.

The EasyTune Interface

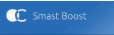
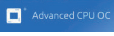

Tabs Information

Tab	Description
 Smart Boost	The Smart Boost tab provides you with different levels of CPU frequency to choose to achieve desired system performance. After making changes, be sure to restart your system for these changes to take effect.
 Advanced CPU OC	The Advanced CPU OC tab allows you to set CPU base clock, frequency, and voltages, and integrated graphics frequency. You can save the current settings to a profile. You can create up to 2 profiles.
 Advanced DDR OC	The Advanced DDR OC tab allows you to set the memory clock.
 Advanced Power	The Advanced Power tab allows you to adjust voltages.
 Hotkey	The HotKey tab allows you to set hotkeys for your profiles.



Available functions in EasyTune may vary by motherboard model and CPU. Grayed-out area(s) indicates that the item is not configurable or the function is not supported.



Incorrectly doing overclock/overvoltage may result in damage to the hardware components such as CPU, chipset, and memory and reduce the useful life of these components. Before you do the overclock/overvoltage, make sure that you fully know each function of EasyTune, or system instability or other unexpected results may occur.

5-2-7 Easy RAID

The GIGABYTE Easy RAID^(Note) utility includes the following 'EZ' setups applications that will offer greatly simplified install and configuration procedures: Disk Mode Switch and XHD.

Disk Mode Switch

Disk Mode Switch allows you to change the SATA controller disk mode from AHCI to RAID mode even after the hard drive has been installed with an operating system. After switching the operating mode, please restart your computer and make sure the Intel® Rapid Storage Technology utility can work properly.

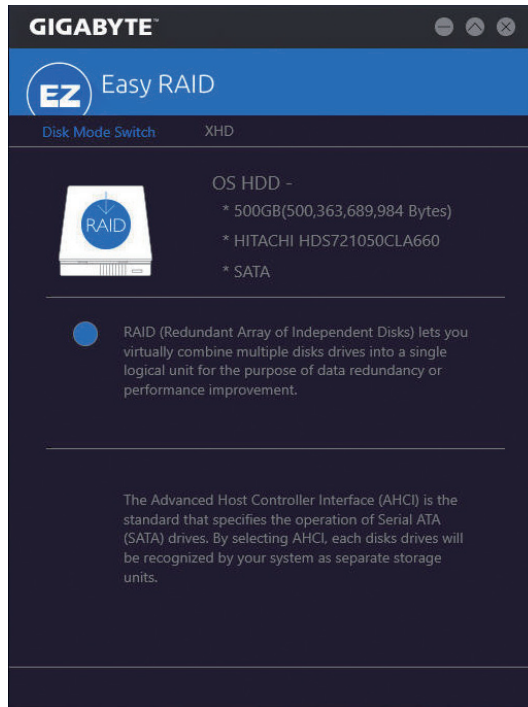

(Note) This feature is supported only in UEFI mode.

XHD

With GIGABYTE XHD ^(Note 1), users can quickly configure a RAID-ready system for RAID 0 when a new SATA drive is added. All with a simple click of a button, XHD helps to enhance your hard drive read/write performance without the need for complex and time-consuming configurations.

A. System Requirements

1. An Intel® Chipset motherboard supporting RAID
2. Intel® SATA controllers set to RAID mode
3. Intel® Rapid Storage Technology utility installed
4. Intel® SATA controller driver installed
5. The new drive must have equal or greater capacity than the system drive.

B. Using XHD

Select **XHD** and click **Create RAID 0** based on your need ^(Note 2).

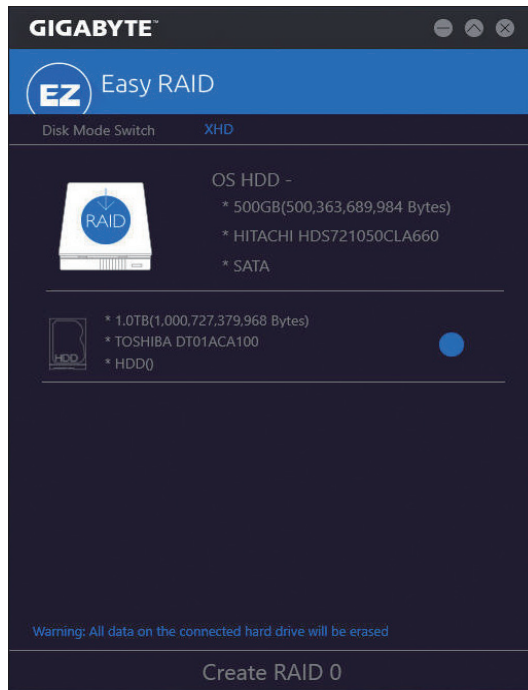

(Note 1) The XHD utility only supports the SATA connectors controlled by the Intel® Chipset.

(Note 2) Except for the operating system drive, all data on other hard drive will be deleted. Back up your data before using the XHD utility.

5-2-8 Fast Boot

Through the simple GIGABYTE Fast Boot interface, you can enable or change the Fast Boot or Next Boot After AC Power Loss setting right in the operating system.

The Fast Boot Interface

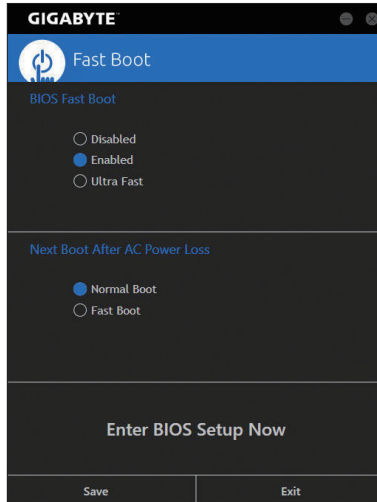

Using Fast Boot

- **BIOS Fast Boot:**

This option is the same as the **Fast Boot** option ^(Note) in BIOS Setup. It allows you to enable or disable the fast boot function to shorten OS boot time.

- **Next Boot After AC Power Loss:**

This option is the same as the **Next Boot After AC Power Loss** option ^(Note) in BIOS Setup. It allows you to select the system bootup mode upon the return of an AC power loss. (This mode is configurable only when **BIOS Fast Boot** is set to **Enabled** or **Ultra Fast**.)

After you configure the settings, click **Save** to save and click **Exit**. The settings will take effect on next boot. If you click the **Enter BIOS Setup Now** button, the system will restart and enter BIOS Setup immediately.

(Note) For more details about this function, refer to Chapter 2, "BIOS."

5-2-9 Game Boost

This app allows you to flexibly manage your applications to optimize your gaming performance by freeing up system resources and memory usage.

The Game Boost Interface

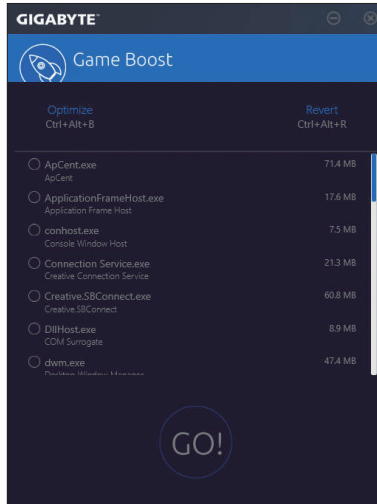

Using Game Boost

Select the application you want to suspend and then click **Go** to optimize your system for gaming. To revert the computer back to the state it was before, click **Revert**. In addition, two hotkeys are provided as follows:

- **Optimize(Ctrl+Alt+B)**: Automatically optimizes your gaming platform and gaming performance.
- **Revert(Ctrl+Alt+R)**: Restores your computer back to the state before the gaming begins.

5-2-10 Platform Power Management

This application allows you to change the Platform Power Management settings in Windows and sync the settings to the BIOS.

The Platform Power Management Interface

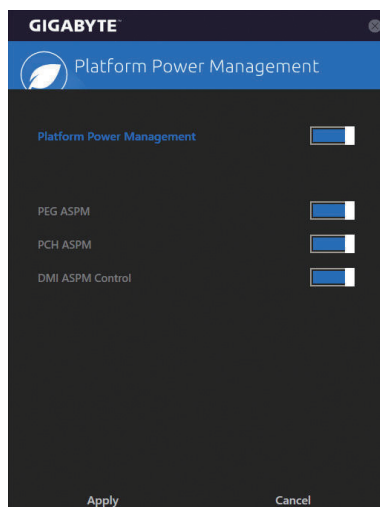

Using Platform Power Management:

- **Platform Power Management:**
Enables or disables the Active State Power Management function (ASPM).
- **PEG ASPM:**
Allows you to configure the ASPM mode for the device connected to the CPU PEG bus.
- **PCH ASPM:**
Allows you to configure the ASPM mode for the device connected to Chipset's PCI Express bus.
- **DMI ASPM Control:**
Allows you to configure the ASPM mode for both CPU side and Chipset side of the DMI link.

(Note) **PEG ASPM, PCH ASPM, DMI ASPM Control** are configurable only when **Platform Power Management** is set to **Enabled**.



5-2-11 RGB Fusion

This application allows you to enable or specify the lighting mode of the onboard LEDs and rear panel LEDs ^(Note 1) while in the Windows environment.

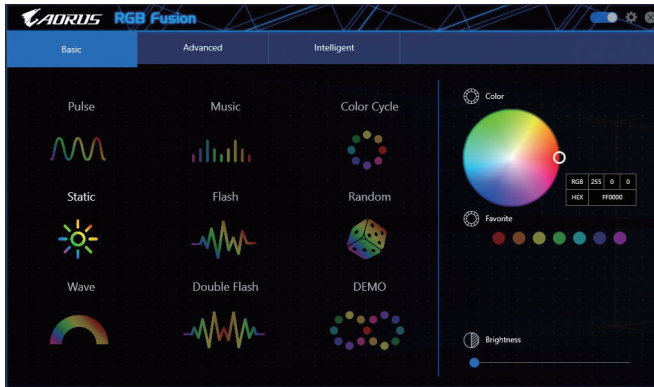
The RGB Fusion Interface



Using RGB Fusion

- The  icon on the top right corner: Allows you to enable or disable the LED lighting.
The  icon on the top right corner: Allows your computer to connect to the GIGABYTE RGB Fusion app installed on your handheld devices ^(Note 2).
- **Basic** ^(Note 3): Allows to you to configure the lighting behavior of all LEDs/armor LEDs.
 - Pulse** - All LEDs simultaneously fade in and fade out.
 - Music** - All LEDs are synchronized with your music.
 - Color Cycle** - All LEDs simultaneously cycle through a full spectrum of colors.
 - Static** - All LEDs emit a single color.
 - Flash** - All LEDs simultaneously flash on and off.
 - Random** - Single LED regions flash randomly.
 - Wave** - A full color spectrum cascades throughout the armor LED.
 - Double Flash** - All LEDs flash in an interlaced pattern.
 - DEMO** - The LEDs/digital LED strip cycle through a full spectrum of analog/digital colors.

(Note 1) This function is available only on motherboards with an I/O shield that has audio LEDs.

(Note 2) Please download the **RGB Fusion** app from App Store or Google Play.

(Note 3) Regions/Modes/Colors available may vary by motherboard.

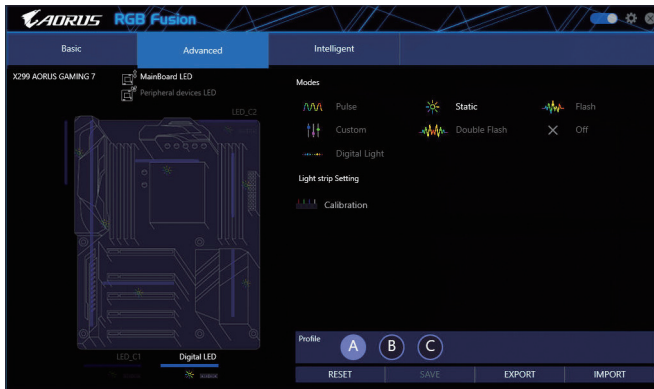

- Advanced** (Note): Allows you to configure the lighting behaviour and color of the LEDs in each region. You can save the settings as a profile and create up to three customized profiles.
 - Pulse** - The selected region LEDs simultaneously fade in and fade out.
 - Static** - The selected region LEDs emit a single color.
 - Flash** - The selected region LEDs simultaneously flash on and off.
 - Custom** - The selected region LEDs can customize the Color stop, mode, color, transition and duration.
 - Double Flash** - The selected region LEDs flash in an interlaced pattern.
 - Off** - Disable the selected region LEDs.
 - Digital Light** - Provides multiple digital lighting mode throughout the armor LED and LED strip.
 - Calibration** - Calibrate LED colors.

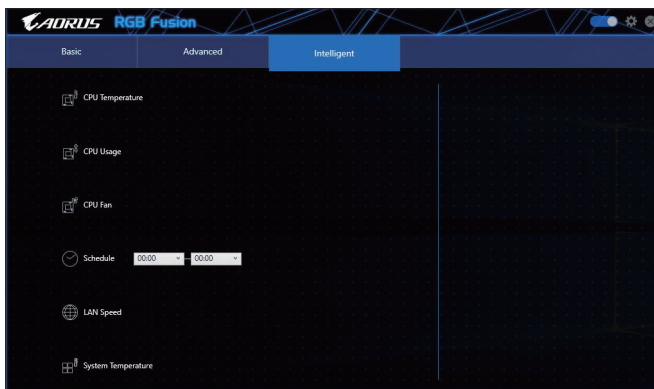

- Intelligent:** LEDs emit various colors based on the condition of your PC.

(Note) Regions/Modes/Colors available may vary by motherboard.

5-2-12 Smart TimeLock

GIGABYTE Smart TimeLock allows you to effectively manage computer or Internet usage time with simple rules and options.

The Smart TimeLock Interface

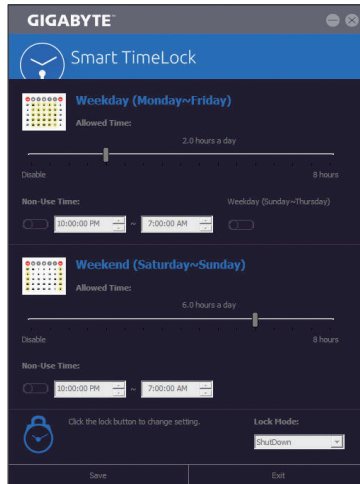

Using Smart TimeLock

Click the lock icon  on the bottom left corner and enter the password ^(Note). Set the time when a user can or cannot use your computer for weekdays and weekends. The **Lock Mode** on the bottom right corner allows you to choose to turn off the computer or only close the Internet connection during the specified time period. Click **Save** to save the settings and click **Exit** to exit.

An alert will appear 15 minutes and 1 minute prior to the default shutdown time. When the alert appears, you can enter the password to extend the usage time or click **Cancel** to close the alert. If you respond **Cancel**, you will be requested to enter the password to extend the usage time again when the default shutdown time arrives, or the computer will shutdown right away.

(Note) You can set the User Password in the system BIOS Setup program to prevent the system time being changed by other users.

5-2-13 Smart Keyboard

GIGABYTE Smart Keyboard allows you to set your own hotkeys using the F1 through F12 keys. You can use the customized hotkeys to change the mouse sensitivity, replace a word or password, open a file or an application, all of which helps to make the most out of your keyboard and mouse.

The Smart Keyboard Interface

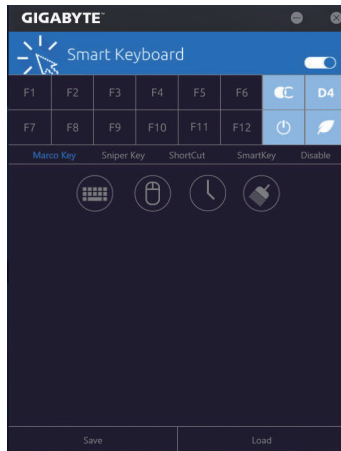

Using Smart Keyboard

Select one of the F1 through F12 keys and configure the following functions:

- **Marco Key:**
Allows you to assign key strokes to the selected key, or use the key to record mouse location, or set time interval between each keystroke.
- **Sniper Key:**
Using this option, you can switch the mouse sensitivity when you are in sniper mode for better sniper accuracy.
- **Smart Cut:**
Allows you to create keyboard shortcuts for a file or an application.
- **Smart Key:**
Allows you to give the selected key the ability to replace to a word or password.
- **Disable:**
Allows you to disable the functionality of particular key(s).

After completing the settings, make sure to click **Enable keyboard monitor function** on the top right corner.

- **Save:**
Save current settings as a profile.
- **Load:**
Load a previously save profile.

(Note) It is recommended that Smart Keyboard be closed if it violates the end user license agreement of your game.

5-2-14 Smart Backup

Smart Backup allows you to back up a partition as an image file every hour. You can use these images to restore your system or files when needed.

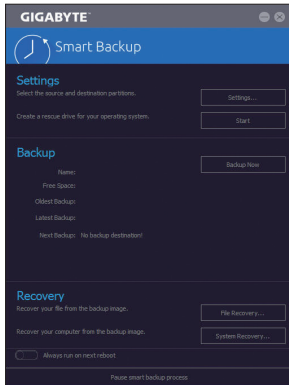

The Smart Backup main menu:

Button	Description
Settings	Allows you to select the source and destination partition
Start	Allows you to create a rescue drive
Backup Now	Allows you to perform the backup immediately
File Recovery...	Allows you to recover your files from the backup image
System Recovery...	Allows you to recover your system from the backup image



- Smart Backup only supports NTFS file system.
- You need to select the destination partition in **Settings** the first time you use Smart Backup.
- The **Backup Now** button will be available only after 10 minutes you have logged in Windows.
- Select the **Always run on next reboot** checkbox to automatically enable Smart Backup after system reboot.

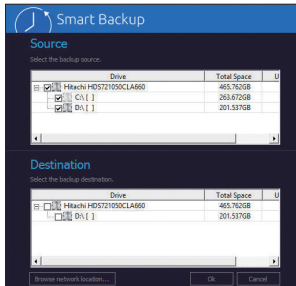

Creating a backup:

Click the **Settings** button on the main menu. In the **Settings** dialog box, select the source partition and destination partition and click **OK**. The initial backup will start after 10 minutes and regular backup will be performed hourly. Note: By default, all partitions on the system drive are selected as the backup source. The backup destination cannot be on the same partition as the backup source.

Saving the backup to a network location:

If you want to save the backup to a network location, select **Browse network location**. Make sure your computer and the computer where you want to save the backup are in the same domain. Choose the network location where you want to store the backup and enter the user name and password. Follow the on-screen instructions to complete.

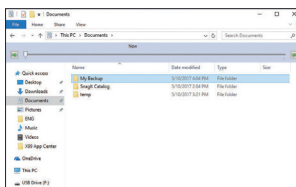

Recovering a file:

Click the **File Recovery** button on the main menu. Use the time slider on the top of the popped out window to select a previous backup time. The right pane will display the backed-up partitions in the backup destination (in the **My Backup** folder). Browse to the file you want and copy it.

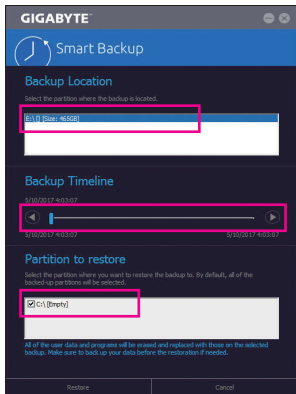

Recovering your system with Smart Backup:

Steps:

1. Click the **System Recovery** button on the main menu.
2. Select the location where your backup is saved.
3. Use the time slider to select a time point.
4. Select a partition backup created on the selected time point and click **Restore**.
5. Confirm whether to restart your system to proceed with the restore immediately or later. Once you respond "Yes" the system will restart to the Windows recovery environment. Follow the onscreen instructions to restore your system.



All of your files and programs will be deleted and replaced with those on the selected backup. If needed, be sure to make a copy of your data before the restore.

5-2-15 Smart HUD

GIGABYTE Smart HUD provides you with the ability to watch a video on YouTube or Twitch simultaneously during gameplay by simply setting the URLs on the UI. The easy-to-use UI allows you to memorize frequently used URLs, set window position and size, and change window transparency. Also, you can control Smart HUD videos and volume with hotkeys.

The Smart HUD Interface

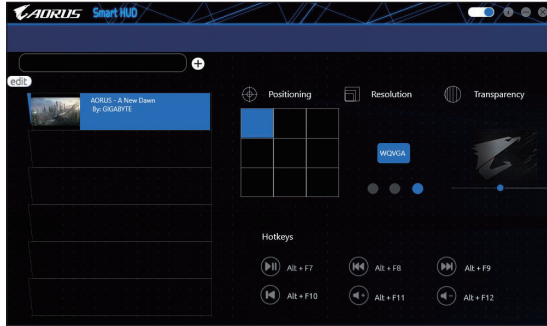

Using Smart HUD

- The  icon on the top right corner:
Allows you to open the Smart HUD window.

- **Configuration Menu:**

[+] / edit	Add or remove video URLs or add preference.
Positioning	Select the window position.
Resolution	Select the window size.
Transparency	Set the window transparency.

- **Hot Keys:**

Alt + F7	Start, pause
Alt + F8	Fast forward
Alt + F9	Fast backward
Alt + F10	Replay
Alt + F11	Increase the volume
Alt + F12	Decrease the volume



5-2-16 System Information Viewer

GIGABYTE System Information Viewer allows you to monitor and adjust the fan speed in the operating system. You can also display the hardware monitor information on the desktop to view the system status at any time.

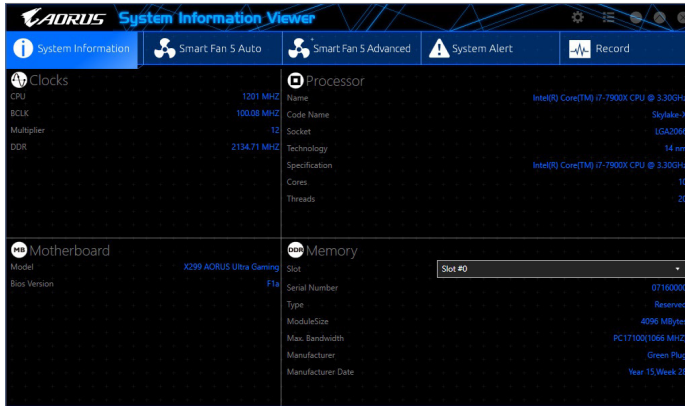
The System Information Viewer Interface

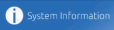
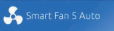
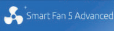

Tabs Information

Tab	Description
 System Information	The System Information tab provides information on the installed CPU, motherboard, and the BIOS version.
 Smart Fan 5 Auto	The Smart Fan 5 Auto tab allows you to specify a Smart Fan mode.
 Smart Fan 5 Advanced	The Smart Fan 5 Advance tab allows you to adjust the smart fan speed. The fans will run at different speeds according to system temperatures. Using the Smart Fan option you can adjust the fan's workload according system temperatures or you can fix the fan speeds using the RPM Fixed Mode option. Click the Calibrate button and the fan speed will be shown in relation to overall fan workload after calibration. The Reset button can revert the fan settings back to the last saved values.
 System Alert	The System Alerts tab allows you to monitor hardware temperature, voltage and fan speed, and set temperature/fan speed alarm.
 Record	The Record tab allows you to record changes in system voltages, temperatures, and fan speeds. Please note, the recording will stop if you exit the Record tab during the recording process.



The speed control function requires the use of a fan with fan speed control design.

5-2-17 USB Blocker

GIGABYTE USB Blocker provides you with an easy-to-use interface that allows you to block certain USB device types on your PC. Devices classes that are blocked will be ignored by the operating system.

The USB Blocker Interface

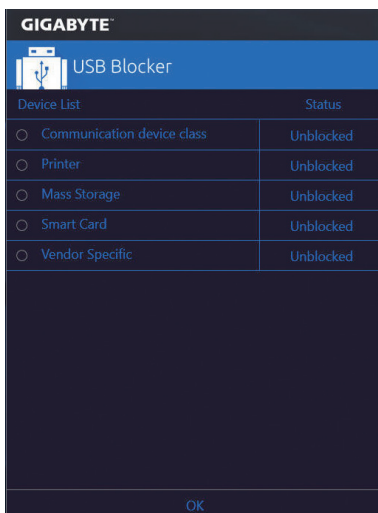

Using USB Blocker

Select the class of USB device that you would like to block or unblock. Double left-click to change the **Blocked** or **Unblocked** status and click **OK**. Then enter your password and click **OK** to complete.

5-2-18 V-Tuner

GIGABYTE V-Tuner ^(Note 1) allows you to easily fine-tune your graphics card in the Windows environment. You can manually overclock the GPU and memory ^(Note 2) or adjust the fan speed and power settings. It also allows you to monitor your graphics card status at any time.

The V-Tuner Interface

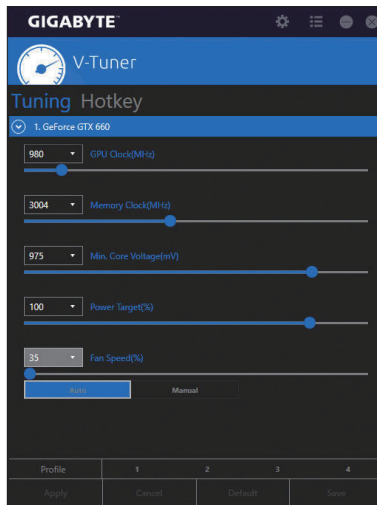

Using V-Tuner

You can manually select the values of each item or use the sliders for adjustment and then click **Apply**. To set the fan speed you need to select **Manual** first. You can save the current settings to a profile and create up to 4 profiles. To check the graphics card status, you can click the  icon on the top right corner.

(Note 1) Before using V-Tuner, be sure to install the graphics card driver first.

(Note 2) Items available may vary by graphics cards.

Chapter 6 Appendix

6-1 Configuring Audio Input and Output

6-1-1 Configuring 2/4/5.1/7.1-Channel Audio

The motherboard provides six audio jacks on the back panel which support 2/4/5.1/7.1-channel ^(Note) audio. The picture to the right shows the default audio jack assignments.



High Definition Audio (HD Audio)

HD Audio includes multiple high quality digital-to-analog converters (DACs) and features multistreaming capabilities that allow multiple audio streams (in and out) to be simultaneously processed. For example, users can listen to MP3 music, have an Internet chat, make a telephone call over the Internet, and etc. all at the same time.

A. Configuring Speakers

Step 1:

After installing the audio driver, restart your computer. On the Windows desktop, click the **Realtek HD Audio Manager** icon  in the notification area to access the HD Audio Manager.

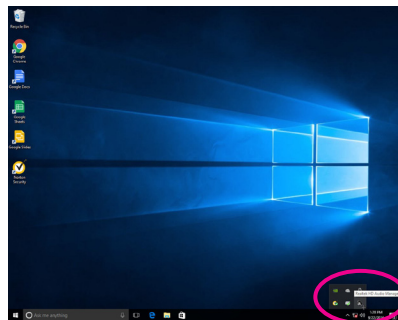

Step 2:

Connect an audio device to an audio jack. The **The current connected device is** dialog box appears. Select the device according to the type of device you connect. Then click **OK**.

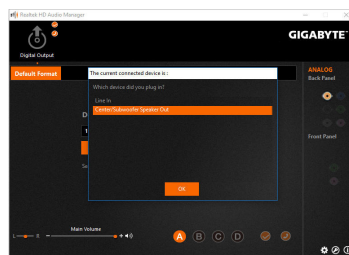

(Note) 2/4/5.1/7.1-Channel Audio Configurations:

Refer to the following for multi-channel speaker configurations.

- 2-channel audio: Headphone or Line out.
- 4-channel audio: Front speaker out and Rear speaker out.
- 5.1-channel audio: Front speaker out, Rear speaker out, and Center/Subwoofer speaker out.
- 7.1-channel audio: Front speaker out, Rear speaker out, Center/Subwoofer speaker out, and Side speaker out.

Step 3:

On the **Speakers** screen, click the **Speaker Configuration** tab. In the **Speaker Configuration** list, select **Stereo**, **Quadraphonic**, **5.1 Speaker**, or **7.1 Speaker** according to the type of speaker configuration you wish to set up. Then the speaker setup is completed.

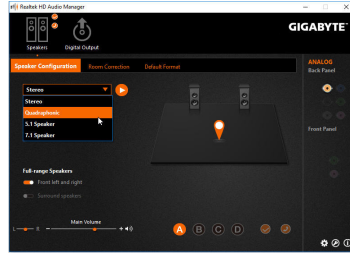

B. Configuring Sound Effect

You may configure an audio environment on the **Sound Effects** tab.

C. Enabling Smart Headphone Amp

The Smart Headphone Amp feature automatically detects impedance of your head-worn audio device, whether earbuds or high-end headphones to provide optimal audio dynamics. To enable this feature, connect your head-worn audio device to the Line out jack on the front panel and then go to the **HD Audio 2nd output** page. Enable the **Smart Headphone Amp** feature. The **Headphone Power** list below allows you to manually set the level of headphone volume, preventing the volume from being too high or too low.

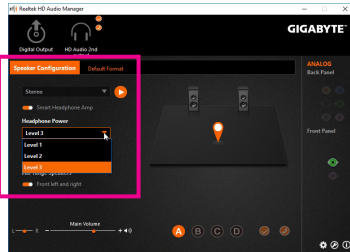

* Configuring the Headphone

When you connect your headphone to the Line out jack on the back panel or front panel, make sure the default playback device is configured correctly.

Step 1:

Locate the  icon in the notification area and right-click on this icon. Select **Playback devices**.

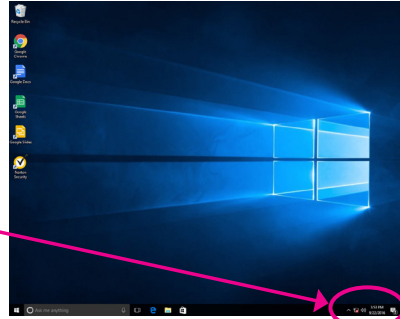

Step 2:

On the **Playback** tab, make sure your headphone is set as the default playback device. For the device connected to the Line out jack on the back panel, right-click on **Speakers** and select **Set as Default Device**; for the device connected to the Line out jack on the front panel, right-click on **Realtek HD Audio 2nd output**.

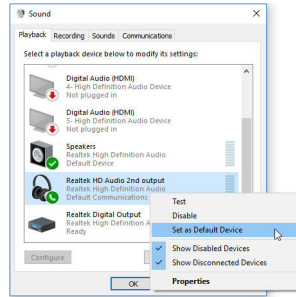

6-1-2 Configuring S/PDIF Out

The S/PDIF Out jack can transmit audio signals to an external decoder for decoding to get the best audio quality.

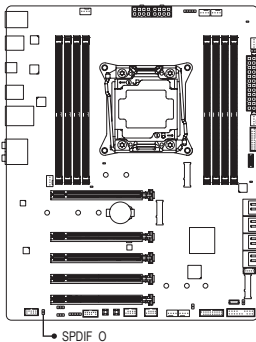

1. Connecting a S/PDIF Out Cable:

Connect a S/PDIF optical cable to the SPDIF_O header as shown on the left and an external decoder for transmitting the S/PDIF digital audio signals.

2. Configuring S/PDIF Out:

On the **Digital Output** screen, click the **Default Format** tab and then select the sample rate and bit depth. Click **OK** to complete.

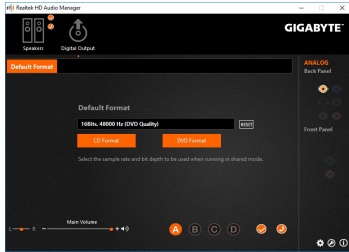

6-1-3 Configuring Microphone Recording

Step 1:

After installing the audio driver, restart your computer. On the Windows desktop, click the **Realtek HD Audio Manager** icon  in the notification area to access the HD Audio Manager.

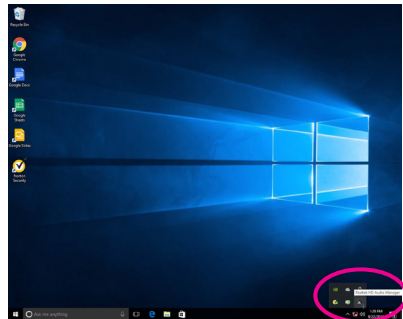

Step 2:

Connect your microphone to the Mic in jack on the back panel or the Mic in jack on the front panel. Then configure the jack for microphone functionality.

Note: The microphone functions on the front panel and back panel cannot be used at the same time.

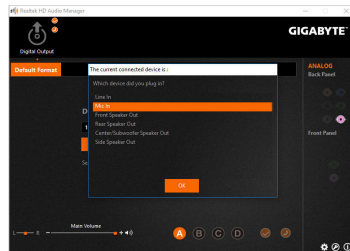

Step 3:

Go to the **Microphone** screen. Do not mute the recording volume, or you'll not be able to record the sound. To hear the sound being recorded during the recording process, do not mute the playback volume. It is recommended that you set the volumes at a middle level.

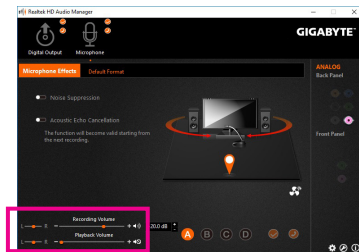

Step 4:

To raise the recording and playback volume for the microphone, you can set the Microphone Boost level on the right of the **Recording Volume** slider.



*** Enabling Stereo Mix**

If the HD Audio Manager does not display the recording device you wish to use, refer to the steps below. The following steps explain how to enable Stereo Mix (which may be needed when you want to record sound from your computer).

Step 1:

Locate the  icon in the notification area and right-click on this icon. Select **Recording devices**.

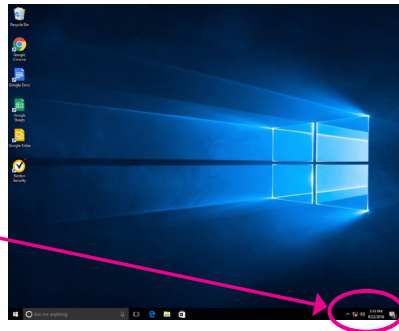

Step 2:

On the **Recording** tab, right-click on **Stereo Mix** item and select **Enable**. Then set it as the default device. (if you do not see **Stereo Mix**, right-click on an empty space and select **Show Disabled Devices**.)

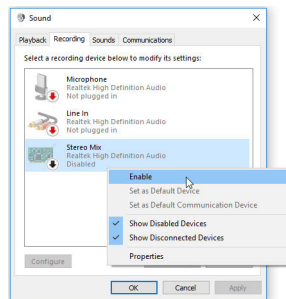

Step 3:

Now you can access the **HD Audio Manager** to configure **Stereo Mix** and use **Voice Recorder** to record the sound.

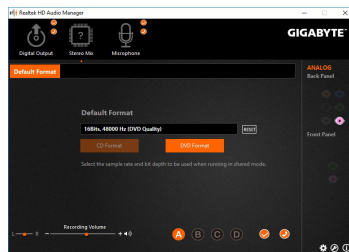

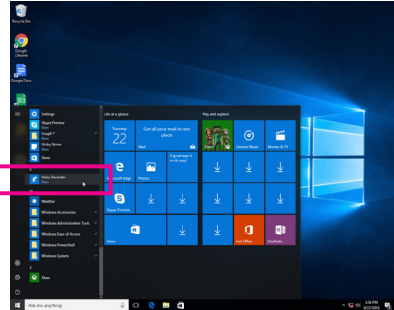

6-1-4 Using the Voice Recorder

After setting up the audio input device, to open the **Voice Recorder**, go to the Start menu and search for **Voice Recorder**.



A. Recording Sound

1. To begin the recording, click the **Record** icon .
2. To stop the recording, click the **Stop recording** icon .

B. Playing the Recorded Sound

The recordings will be saved in Documents>Sound Recordings. Voice Recorder records audio in MPEG-4 (.m4a) format. You can play the recording with a digital media player program that supports the audio file format.

6-1-5 Sound BlasterX 720°

Launch the Sound Blaster Connect 2 utility from the Start menu or click the  icon in the notification area.

Dashboard:

BlasterX Experience gives you a selection of professionally tuned audio profiles. The customizable audio profiles create a unique and optimal sound experience for popular game titles and most of your playback needs. Select a BlasterX Experience, view the current audio preset, and then adjust the settings based on your needs, such as enable Reality 3D to enhance immersion or enable/disable equalizer, Scout Mode, etc.

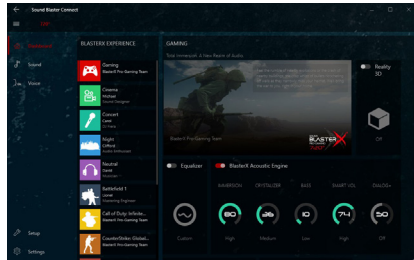

Sound:

Each audio preset can be further customized according to your acoustic preference for music, games and movies.

- **REALITY 3D**
Boost and enhance 3D immersion for your entertainment in music, movies and games.
- **EQUALIZER**
Select from a plethora of Equalizer presets to match your audio, or enhance the bass or treble to your liking with our graphic equalizer.
- **ACOUSTIC ENGINE**
Enhance and tweak your auditory experience to perfection with intelligent controls powered by BlasterX Acoustic Engine.
- **SCOUT 2.0**
A new and improved Scout Mode that not only lets you hear, but also visualize your enemies on the battle field. Scout Radar transforms your mobile device into a radar display that reveals your enemy's location in realtime. Now, besides hearing your enemies, you can actually visualize and pinpoint your enemy's position. (Requires an Internet connection and the Scout Radar mobile app must be installed on your mobile device.)

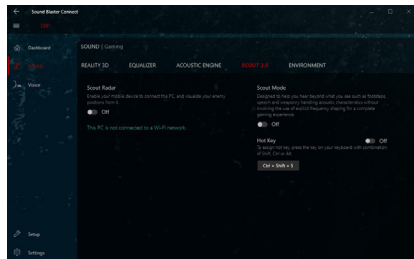

The screen shot of the Scout Radar app

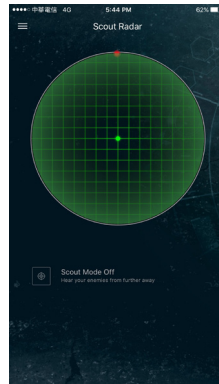

Please note the following when using the Scout Radar feature:



- The Scout Radar feature is not supported if you connect the output device to the Line out jack on the front panel.
- Download the Scout Radar app from App Store or Google Play and install it on your mobile device.
- Your mobile device and PC have to connect to the Internet via the same router.
- If you use a headphone as the audio output device, go to "Setup>Select Speaker Configuration" to select 4.0/5.1/7.1-channel and set **Enable headphone mode for your speaker output to On.**

- ENVIRONMENT

State-of-the-art multi-environment rendering and reverb modeling offers a realistic and immersive 3D gaming experience to add more immersion to your listening experience.

Voice Settings:

Improve your voice quality and inject fun into your in-game chats, broadcasts to social media with voice enhancements.

- Clarity

Powered by Crystal Voice, you can significantly reduce noise and feedback as you speak in real-time.

Noise Reduction enables the speaker to be heard clearly over background noise.

Acoustic Echo Cancellation eliminates echoes and enables the speaker to listen to the other party clearly. Smart Volume automatically adjusts the loudness of the speaker's voice to maintain a consistent volume level.

Voice Enhancer enhances the tone of your voice to suit your usage. Select a list of presets.

- VOICE MORPH

Have fun changing your voice to different characters during game play, game casting or recordings. Select one of the many Voice Morph options to enhance your tone or create interesting accents and sound like a completely different person.

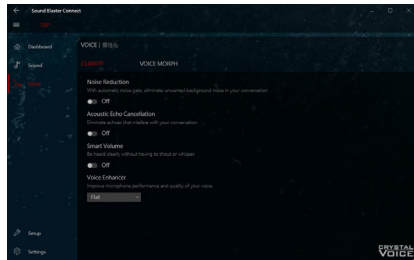

Setup:

For the best listening experience, you can optimize the audio output to work with your preferred audio device.

- Speakers

Set the audio output according to your connected headphones/speakers.

- Calibration

Sound Blaster Connect can help you calibrate your speakers to match the unique acoustics of your room, so you always get the best audio possible.

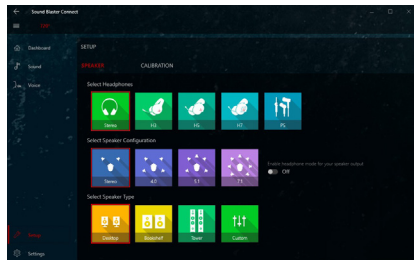

Settings:

Set application language and the distance measuring unit, or check for software updates (requires an Internet connection). Or revert all of the settings to the factory defaults.

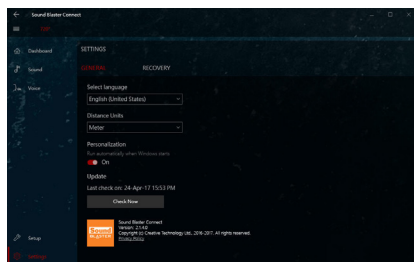

(Note) For more information on Sound BlasterX 720°, please visit the CREATIVE® website.

6-2 Troubleshooting

6-2-1 Frequently Asked Questions

To read more FAQs for your motherboard, please go to the **SupportFAQ** page on GIGABYTE's website.

Q: Why is the light of my keyboard/optical mouse still on after the computer shuts down?

A: Some motherboards provide a small amount of standby power after the computer shuts down and that's why the light is still on.

Q: How do I clear the CMOS values?

A: For motherboards that have a Clear CMOS button, press this button to clear the CMOS values (before doing this, please turn off the computer and unplug the power cord). For motherboards that have a Clear CMOS jumper, refer to the instructions in Chapter 1 to short the jumper to clear the CMOS values. If your board doesn't have this jumper/button, refer to the instructions on the motherboard battery in Chapter 1. You can temporarily remove the battery from the battery holder to stop supplying power to the CMOS, which will clear the CMOS values after about one minute.

Q: Why do I still get a weak sound even though I have turned my speaker to the maximum volume?

A: Make sure your speaker is equipped with an internal amplifier. If not, try a speaker with power/amplifier.

6-2-2 Troubleshooting Procedure

If you encounter any troubles during system startup, follow the troubleshooting procedure below to solve the problem.

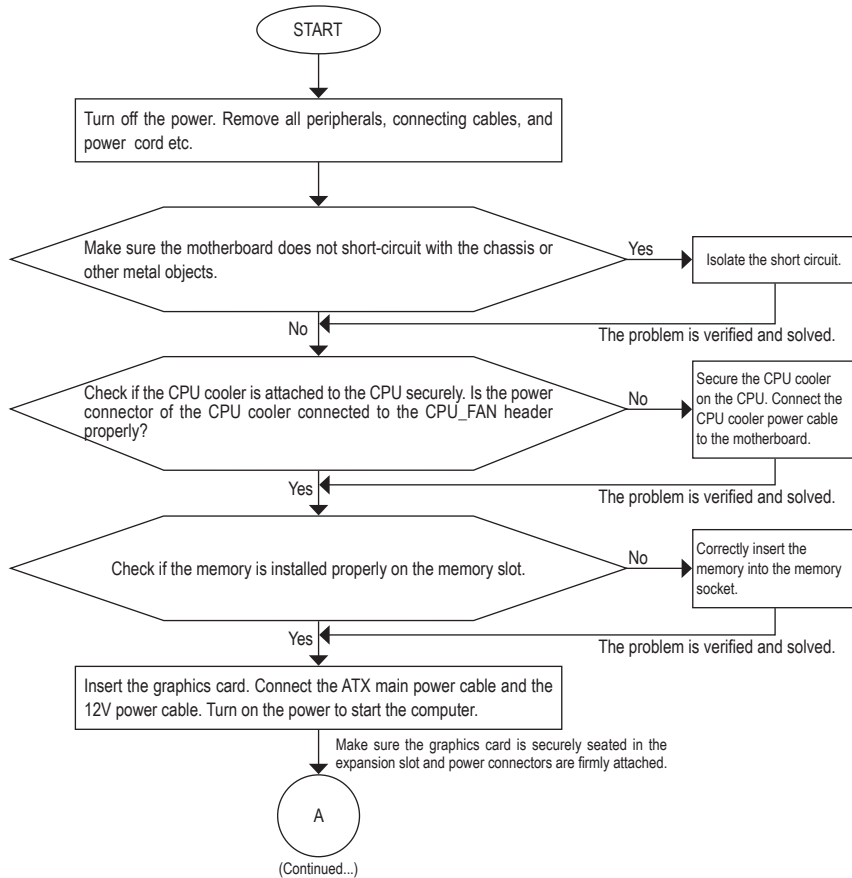

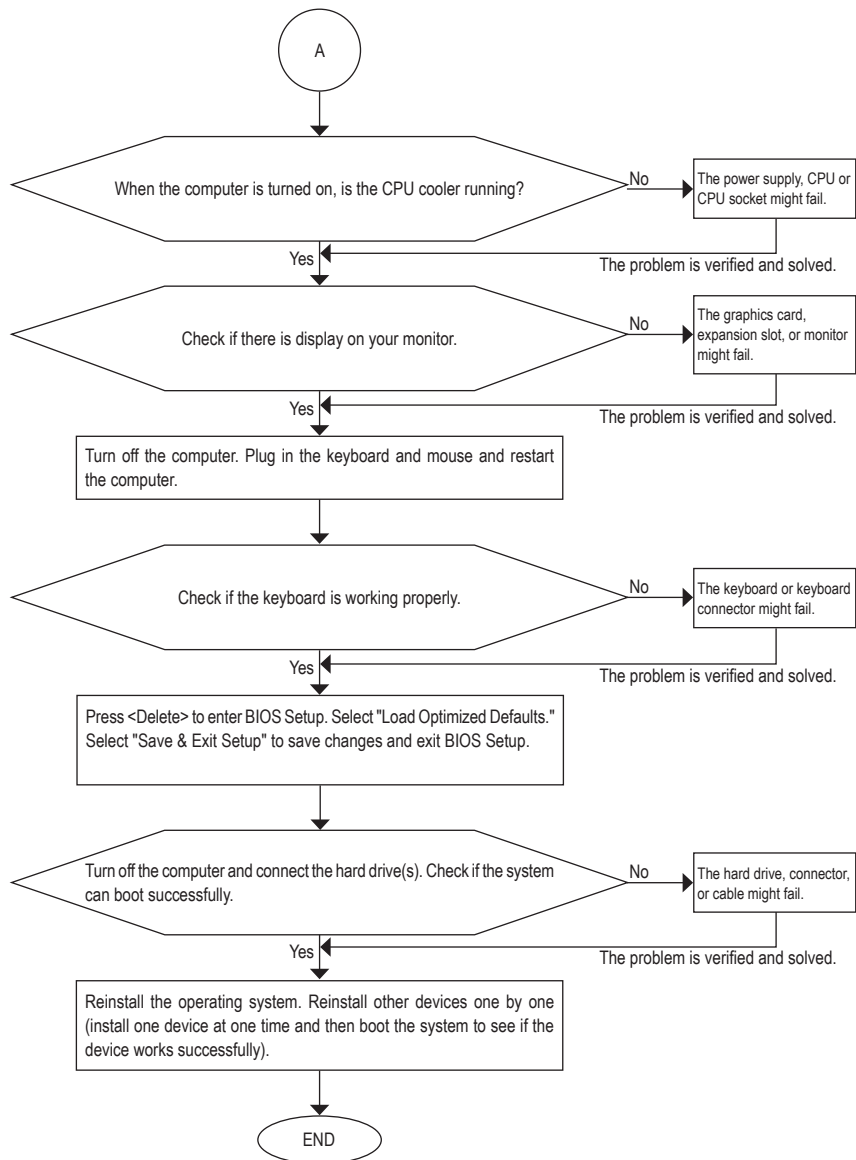

If the procedure above is unable to solve your problem, contact the place of purchase or local dealer for help. Or go to the **Support\Technical Support** page to submit your question. Our customer service staff will reply you as soon as possible.

Regulatory Statements

Regulatory Notices

This document must not be copied without our written permission, and the contents there of must not be imparted to a third party nor be used for any unauthorized purpose. Contravention will be prosecuted. We believe that the information contained herein was accurate in all respects at the time of printing. GIGABYTE cannot, however, assume any responsibility for errors or omissions in this text. Also note that the information in this document is subject to change without notice and should not be construed as a commitment by GIGABYTE.

Our Commitment to Preserving the Environment

In addition to high-efficiency performance, all GIGABYTE motherboards fulfill European Union regulations for RoHS (Restriction of Certain Hazardous Substances in Electrical and Electronic Equipment) and WEEE (Waste Electrical and Electronic Equipment) environmental directives, as well as most major worldwide safety requirements. To prevent releases of harmful substances into the environment and to maximize the use of our natural resources, GIGABYTE provides the following information on how you can responsibly recycle or reuse most of the materials in your "end of life" product.

Restriction of Hazardous Substances (RoHS) Directive Statement

GIGABYTE products have not intended to add and safe from hazardous substances (Cd, Pb, Hg, Cr+6, PBDE and PBB). The parts and components have been carefully selected to meet RoHS requirement. Moreover, we at GIGABYTE are continuing our efforts to develop products that do not use internationally banned toxic chemicals.

Waste Electrical & Electronic Equipment (WEEE) Directive Statement

GIGABYTE will fulfill the national laws as interpreted from the 2002/96/EC WEEE (Waste Electrical and Electronic Equipment) directive. The WEEE Directive specifies the treatment, collection, recycling and disposal of electric and electronic devices and their components. Under the Directive, used equipment must be marked, collected separately, and disposed of properly.

WEEE Symbol Statement



The symbol shown below is on the product or on its packaging, which indicates that this product must not be disposed of with other waste. Instead, the device should be taken to the waste collection centers for activation of the treatment, collection, recycling and disposal procedure. The separate collection and recycling of your waste equipment at the time of disposal will help to conserve natural resources and ensure that it is recycled in a manner that protects human health and the environment.

For more information about where you can drop off your waste equipment for recycling, please contact your local government office, your household waste disposal service or where you purchased the product for details of environmentally safe recycling.

- When your electrical or electronic equipment is no longer useful to you, "take it back" to your local or regional waste collection administration for recycling.
- If you need further assistance in recycling, reusing in your "end of life" product, you may contact us at the Customer Care number listed in your product's user's manual and we will be glad to help you with your effort.

Finally, we suggest that you practice other environmentally friendly actions by understanding and using the energy-saving features of this product (where applicable), recycling the inner and outer packaging (including shipping containers) this product was delivered in, and by disposing of or recycling used batteries properly. With your help, we can reduce the amount of natural resources needed to produce electrical and electronic equipment, minimize the use of landfills for the disposal of "end of life" products, and generally improve our quality of life by ensuring that potentially hazardous substances are not released into the environment and are disposed of properly.

FCC Notice (U.S.A. Only)

This equipment has been tested and found to comply with the limits for a Class B digital device, pursuant to Part 15 of the FCC Rules. These limits are designed to provide reasonable protection against harmful interference in a residential installation. This equipment generates, uses, and can radiate radio frequency energy and, if not installed and used in accordance with the instructions, may cause harmful interference to radio communications. However, there is no guarantee that interference will not occur in a particular installation. If this equipment does cause harmful interference to radio or television reception, which can be determined by turning the equipment off and on, the user is encouraged to try to correct the interference by one or more of the following measures:

- ◆ Reorient or relocate the receiving antenna.
- ◆ Increase the separation between the equipment and receiver.
- ◆ Connect the equipment into an outlet on a circuit different from that to which the receiver is connected.
- ◆ Consult a dealer or experienced TV/radio technician for help.

Canada, Industry Canada (IC) Notices / Canada, avis d'Industry Canada (IC)

- ◆ This Class B digital apparatus complies with Canadian ICES-003 and RSS-210.
- ◆ Operation is subject to the following two conditions: (1) this device may not cause interference, and (2) this device must accept any interference, including interference that may cause undesired operation of the device.
- ◆ Cet appareil numérique de classe B est conforme aux normes canadiennes ICES-003 et RSS-210.
- ◆ Son fonctionnement est soumis aux deux conditions suivantes : (1) cet appareil ne doit pas causer d'interférence et (2) cet appareil doit accepter toute interférence, notamment les interférences qui peuvent affecter son fonctionnement.



Contact Us

- **GIGA-BYTE TECHNOLOGY CO., LTD.**

Address: No.6, Baoqiang Rd., Xindian Dist.,

New Taipei City 231, Taiwan

TEL: +886-2-8912-4000

FAX: +886-2-8912-4005

Tech. and Non-Tech. Support (Sales/Marketing) :

<http://esupport.gigabyte.com>

WEB address (English): <http://www.gigabyte.com>

WEB address (Chinese): <http://www.gigabyte.tw>

- **G.B.T. INC. - U.S.A.**

TEL: +1-626-854-9338

FAX: +1-626-854-9326

Tech. Support: <http://esupport.gigabyte.com>

Warranty Info: <http://rma.gigabyte.us>

Web address: <http://www.gigabyte.us>

- **G.B.T. INC (USA) - Mexico**

Tel: +1-626-854-9338 x 215 (Soporte de habla hispano)

FAX: +1-626-854-9326

Correo: soporte@gigabyte-usa.com

Tech. Support: <http://rma.gigabyte.us>

Web address: <http://latam.giga-byte.com>

- **Giga-Byte SINGAPORE PTE. LTD. - Singapore**

WEB address : <http://www.gigabyte.sg>

- **Thailand**

WEB address : <http://th.giga-byte.com>

- **Vietnam**

WEB address : <http://www.gigabyte.vn>

- **NINGBO G.B.T. TECH. TRADING CO., LTD. - China**

WEB address : <http://www.gigabyte.cn>

- Shanghai**

TEL: +86-21-63400912

FAX: +86-21-63400682

- Beijing**

TEL: +86-10-62102838

FAX: +86-10-62102848

- Wuhan**

TEL: +86-27-87685981

FAX: +86-27-87579461

- GuangZhou**

TEL: +86-20-87540700

FAX: +86-20-87544306

- Chengdu**

TEL: +86-28-85483135

FAX: +86-28-85256822

- Xian**

TEL: +86-29-85531943

FAX: +86-29-85510930

- Shenyang**

TEL: +86-24-83992342

FAX: +86-24-83992102

- **GIGABYTE TECHNOLOGY (INDIA) LIMITED - India**

WEB address : <http://www.gigabyte.in>

- **Saudi Arabia**

WEB address : <http://www.gigabyte.com.sa>

- **Gigabyte Technology Pty. Ltd. - Australia**

WEB address : <http://www.gigabyte.com.au>

- **G.B.T. TECHNOLOGY TRADING GMBH - Germany**

WEB address : <http://www.gigabyte.de>

- **G.B.T. TECH. CO., LTD. - U.K.**

WEB address : <http://www.giga-byte.co.uk>

- **Giga-Byte Technology B.V. - The Netherlands**

WEB address : <http://www.giga-byte.nl>

- **GIGABYTE TECHNOLOGY FRANCE - France**

WEB address : <http://www.gigabyte.fr>

- **Sweden**

WEB address : <http://www.gigabyte.se>

- **Italy**

WEB address : <http://www.giga-byte.it>

- **Spain**

WEB address : <http://www.giga-byte.es>

- **Greece**

WEB address : <http://www.gigabyte.com.gr>

- **Czech Republic**

WEB address : <http://www.gigabyte.cz>

- **Hungary**

WEB address : <http://www.giga-byte.hu>

- **Turkey**

WEB address : <http://www.gigabyte.com.tr>

- **Russia**

WEB address : <http://www.gigabyte.ru>

- **Poland**

WEB address : <http://www.gigabyte.pl>

- **Ukraine**

WEB address : <http://www.gigabyte.ua>

- **Romania**

WEB address : <http://www.gigabyte.com.ro>

- **Serbia**

WEB address : <http://www.gigabyte.co.rs>

- **Kazakhstan**

WEB address : <http://www.gigabyte.kz>

- **GIGABYTE eSupport**

To submit a technical or non-technical (Sales/Marketing) question, please link to:

<http://esupport.gigabyte.com>

