

B360N WIFI B360N GSM

User's Manual

Rev. 1002

12ME-360NWFI-1002R

B360N WIFI



B360N GSM



For more product details, please visit [GIGABYTE's website](#).



To reduce the impacts on global warming, the packaging materials of this product are recyclable and reusable. GIGABYTE works with you to protect the environment.

Declaration of Conformity

We, Manufacturer/Importer,
G.B.T. Technology Trading GmbH
 Address: **Bullenkoppel 16, 22047 Hamburg, Germany**
 Declares that the product
 Product Type: **Motherboard**
 Product Name: **B360N WIFI**

conforms with the essential requirements of the following directives:

- EMC Directive 2014/30/EU:**

<input checked="" type="checkbox"/> Conduction & Radiated Emissions:	EN 55032:2012/AC:2013
<input checked="" type="checkbox"/> Immunity:	EN 55024:2010+A1:2015
<input checked="" type="checkbox"/> Power-line harmonics:	EN 61000-3-2:2014
<input checked="" type="checkbox"/> Power-line flicker:	EN 61000-3-3:2013
- Low Voltage Directive (LVD) 2014/35/EU:**

<input checked="" type="checkbox"/> Safety:	EN 60950-1:2006+A11:2009+A12:2011+A1:2010+AC:2011+A2:2013 EN 50566:2013/AC:2014, EN 62368-1:2014
---	---
- Radio Equipment Directive (RED) 2014/53/EU:**

Wireless module model name:	9560NGW
Wireless module manufacturer:	Intel Mobile Communications SAS
<input checked="" type="checkbox"/> Technical Requirements:	EN 300 328 v2.1.1, EN 301 893 v1.8.1 & v2.1.1 (Rx blocking) EN 301 489-1 v2.2.0, EN 301 489-17 v3.2.0, EN 55032:2015, EN 300 440-1 v1.8.1, EN 300 440-2 v1.4.1, EN 300 440 v2.1.1 (Rx blocking)
- RoHS Directive 2011/65/EU**

<input checked="" type="checkbox"/> Restriction of use of certain substances in electronic equipment:	This product does not contain any of the restricted substances listed in Annex II, in concentrations and applications banned by the directive.
---	--
- CE marking**



Signature: Timmy Huang

(Date) Date: Mar. 16, 2018 Name: Timmy Huang

DECLARATION OF CONFORMITY

Per FCC Part 2 Section 2.1077(a)



Responsible Party Name: G.B.T. INC. (U.S.A.)

**Address: 17358 Railroad Street
 City of Industry, CA 91748**

Phone/Fax No: (626) 854-9338/ (626) 854-9326

hereby declares that the product

Product Name: Motherboard

Model Number: B360N WIFI

Conforms to the following specifications:

FCC Part 15, Subpart B, Section 15.107(a) and Section 15.109 (a), Class B Digital Device

Supplementary Information:

This device complies with part 15 of the FCC Rules. Operation is subject to the following two conditions: (1) This device may not cause harmful and (2) this device must accept any interference received, including that may cause undesired operation.

Representative Person's Name: ERIC LU

Signature: Eric Lu

Date: Mar. 16, 2018

Wireless Module Country Approvals:

United States: FCC: PD99560NG	Japan: 003-170126 D170080003 5.15~5.35GHz indoor use only	Serbia: V011 17
Canada: IC: 1000M-9560NG	Mexico: RCPIN9517-1584	Singapore Complies with IDA standards DB 02941
Australia & New-Zealand: 		Taiwan: CCAH18LP0140T0
China: CMIIT ID: 2017AJ4643 (M)	South Korea: MSIP-CRM-INT-9560NGW 1. 상호명: Intel Corporation 2. 기자재의 명칭(모델명): 특정소출력 무선기기 (무선랜을 포함한 무선접속시스템용 무선기기) 9560NGW 3. 제조 시기: 2017/07 4. 제조사/제조국: Intel Corporation/China	UAE: ER57050/17
European Union: 		Ukraine: UA.TR.028
India: 2.4GHZ: NR-ETA/6863 5GHZ: NR-ETA/6862		

Declaration of Conformity

We, Manufacturer/Importer,

G.B.T. Technology Trading GmbH

Address: Bullenkoppel 16, 22047 Hamburg, Germany

Declare that the product

Product Type: **Motherboard**

Product Name: **B360N GSM**

conforms with the essential requirements of the following directives:

EMC Directive 2014/30/EU:

<input checked="" type="checkbox"/> Conduction & Radiated Emissions:	EN 55032:2012+AC:2013
<input checked="" type="checkbox"/> Immunity:	EN 55024:2010+A1:2015
<input checked="" type="checkbox"/> Power-line harmonics:	EN 61000-3-2:2014
<input checked="" type="checkbox"/> Power-line flicker:	EN 61000-3-3:2013

Low Voltage Directive 2014/35/EU:

<input checked="" type="checkbox"/> Safety:	EN60950-1:2006+A11:2009+A12:2011+A2:2013
---	--

RoHS Directive 2011/65/EU

<input checked="" type="checkbox"/> Restriction of use of certain substances in electronic equipment:	This product does not contain any of the restricted substances listed in Annex II, in concentrations and applications banned by the directive.
---	--

CE marking



Signature: Timmy Huang

(Stamp)

Date: May, 11, 2018

Name: Timmy Huang

DECLARATION OF CONFORMITY

Per FCC Part 2 Section 2.1077(a)



Responsible Party Name: G.B.T. INC. (U.S.A.)

Address: 17358 Railroad Street

City of Industry, CA 91748

Phone/Fax No: (626) 854-9338/ (626) 854-9326

hereby declares that the product

Product Name: **Motherboard**

Model Number: B360N GSM

Conforms to the following specifications:

FCC Part 15, Subpart B, Section 15.107(a) and Section 15.109 (a), Class B Digital Device

Supplementary Information:

This device complies with part 15 of the FCC Rules. Operation is subject to the following two conditions: (1) This device may not cause harmful and (2) this device must accept any interference received, including that may cause undesired operation.

Representative Person's Name: ERIC LU

Signature: Eric Lu

Date: May 11, 2018

Copyright

© 2018 GIGA-BYTE TECHNOLOGY CO., LTD. All rights reserved.

The trademarks mentioned in this manual are legally registered to their respective owners.

Disclaimer

Information in this manual is protected by copyright laws and is the property of GIGABYTE.

Changes to the specifications and features in this manual may be made by GIGABYTE without prior notice.

No part of this manual may be reproduced, copied, translated, transmitted, or published in any form or by any means without GIGABYTE's prior written permission.

- For detailed product information, carefully read the User's Manual.
- For product-related information, check on our website at: <http://www.gigabyte.com>

Identifying Your Motherboard Revision

The revision number on your motherboard looks like this: "REV: X.X." For example, "REV: 1.0" means the revision of the motherboard is 1.0. Check your motherboard revision before updating motherboard BIOS, drivers, or when looking for technical information.

Example:

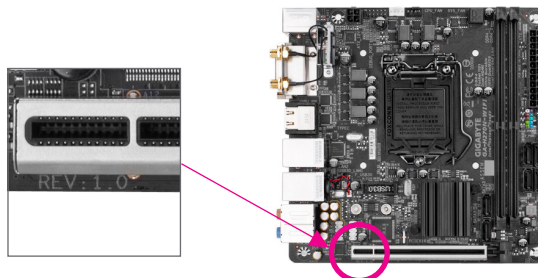
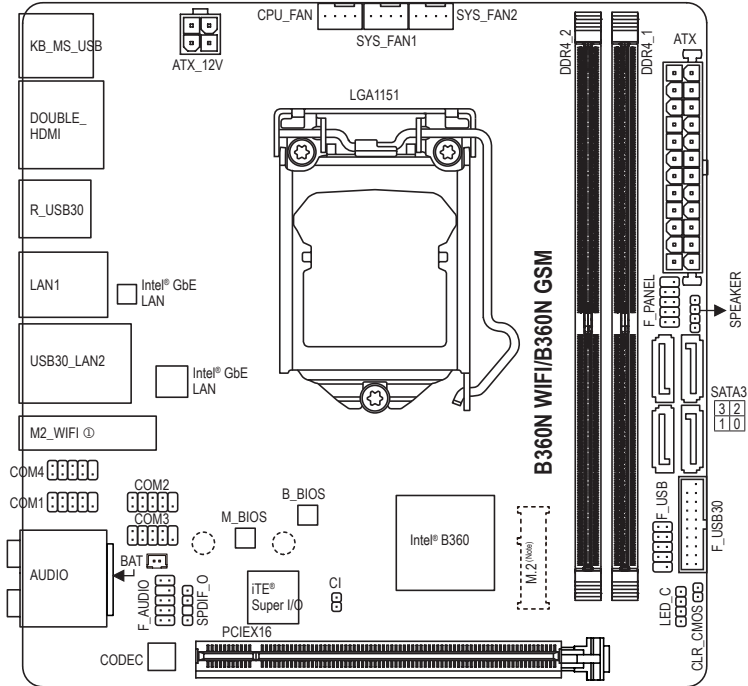

Table of Contents

B360N WIFI/B360N GSM Motherboard Layout.....	5
Chapter 1 Hardware Installation	6
1-1 Installation Precautions.....	6
1-2 Product Specifications.....	7
1-3 Installing the CPU	10
1-4 Installing the Memory.....	10
1-5 Installing an Expansion Card	11
1-6 Back Panel Connectors.....	11
1-7 Internal Connectors.....	13
Chapter 2 BIOS Setup	20
2-1 Startup Screen	20
2-2 The Main Menu	21
2-3 M.I.T.	22
2-4 System	28
2-5 BIOS.....	29
2-6 Peripherals	32
2-7 Chipset.....	35
2-8 Power	36
2-9 Save & Exit.....	38
Chapter 3 Appendix.....	39
3-1 Installing an Intel® Optane™ Memory.....	39
3-2 Drivers Installation.....	40
Regulatory Statements.....	41
Contact Us	48

B360N WIFI/B360N GSM Motherboard Layout



Box Contents

- B360N WIFI or B360N GSM Motherboard
- Two SATA cables
- Motherboard driver disk
- I/O Shield
- User's Manual
- One antenna ①

* The box contents above are for reference only and the actual items shall depend on the product package you obtain.
The box contents are subject to change without notice.

① Only for B360N WIFI.

(Note) The connector is on the back of the motherboard.











Chapter 1 Hardware Installation

1-1 Installation Precautions

The motherboard contains numerous delicate electronic circuits and components which can become damaged as a result of electrostatic discharge (ESD). Prior to installation, carefully read the user's manual and follow these procedures:





- Prior to installation, make sure the chassis is suitable for the motherboard.
- Prior to installation, do not remove or break motherboard S/N (Serial Number) sticker or warranty sticker provided by your dealer. These stickers are required for warranty validation.
- Always remove the AC power by unplugging the power cord from the power outlet before installing or removing the motherboard or other hardware components.
- When connecting hardware components to the internal connectors on the motherboard, make sure they are connected tightly and securely.
- When handling the motherboard, avoid touching any metal leads or connectors.
- It is best to wear an electrostatic discharge (ESD) wrist strap when handling electronic components such as a motherboard, CPU or memory. If you do not have an ESD wrist strap, keep your hands dry and first touch a metal object to eliminate static electricity.
- Prior to installing the motherboard, please have it on top of an antistatic pad or within an electrostatic shielding container.
- Before connecting or unplugging the power supply cable from the motherboard, make sure the power supply has been turned off.
- Before turning on the power, make sure the power supply voltage has been set according to the local voltage standard.
- Before using the product, please verify that all cables and power connectors of your hardware components are connected.
- To prevent damage to the motherboard, do not allow screws to come in contact with the motherboard circuit or its components.
- Make sure there are no leftover screws or metal components placed on the motherboard or within the computer casing.
- Do not place the computer system on an uneven surface.
- Do not place the computer system in a high-temperature or wet environment.
- Turning on the computer power during the installation process can lead to damage to system components as well as physical harm to the user.
- If you are uncertain about any installation steps or have a problem related to the use of the product, please consult a certified computer technician.
- If you use an adapter, extension power cable, or power strip, ensure to consult with its installation and/or grounding instructions.





1-2 Product Specifications

	CPU	<ul style="list-style-type: none"> ◆ Support for 8th Generation Intel® Core™ i7 processors/Intel® Core™ i5 processors/Intel® Core™ i3 processors/Intel® Pentium® processors/Intel® Celeron® processors in the LGA1151 package (Go to GIGABYTE's website for the latest CPU support list.) ◆ L3 cache varies with CPU
	Chipset	<ul style="list-style-type: none"> ◆ Intel® B360 Express Chipset
	Memory	<ul style="list-style-type: none"> ◆ 2 x DDR4 DIMM sockets supporting up to 32 GB of system memory ◆ Dual channel memory architecture ◆ Support for DDR4 2666/2400/2133 MHz memory modules ◆ Support for ECC Un-buffered DIMM 1Rx8/2Rx8 memory modules (operate in non-ECC mode) ◆ Support for non-ECC Un-buffered DIMM 1Rx8/2Rx8/1Rx16 memory modules ◆ Support for Extreme Memory Profile (XMP) memory modules <ul style="list-style-type: none"> * To support 2666 MHz or XMP memory, you must install an 8th Generation Intel® Core™ i7/i5 processor. <p>(Go to GIGABYTE's website for the latest supported memory speeds and memory modules.)</p>
	Onboard Graphics	<ul style="list-style-type: none"> ◆ Integrated Graphics Processor-Intel® HD Graphics support: <ul style="list-style-type: none"> - 2 x HDMI ports, supporting a maximum resolution of 4096x2160@30 Hz * Support for HDMI 1.4 version and HDCP 2.2. ◆ Maximum shared memory of 1 GB
	Audio	<ul style="list-style-type: none"> ◆ Realtek® ALC887 codec ◆ High Definition Audio ◆ 2/4/5.1/7.1-channel ◆ Support for S/PDIF Out
	LAN	<ul style="list-style-type: none"> ◆ 2 x Intel® GbE LAN chips (10/100/1000 Mbit)
	Wireless Communication Module ①	<ul style="list-style-type: none"> ◆ Intel® CNVi interface 802.11a/b/g/n/ac, supporting 2.4/5 GHz Dual-Band ◆ BLUETOOTH 5 ◆ Support for 11ac 160 MHz wireless standard and up to 1.73 Gbps data rate <ul style="list-style-type: none"> * Actual data rate may vary depending on environment and equipment.
	Expansion Slots	<ul style="list-style-type: none"> ◆ 1 x PCI Express x16 slot, running at x16 (The PCIEX16 slot conforms to PCI Express 3.0 standard.) ◆ 1 x M.2 Socket 1 connector for an Intel® CNVi wireless module (M2_WIFI) ②
	Storage Interface	<ul style="list-style-type: none"> ◆ Chipset: <ul style="list-style-type: none"> - 1 x M.2 connector on the back of the motherboard (Socket 3, M key, type 2260/2280 SATA and PCIe x4/x2 SSD support) - 4 x SATA 6Gb/s connectors ◆ Intel® Optane™ Memory Ready
	USB	<ul style="list-style-type: none"> ◆ Chipset: <ul style="list-style-type: none"> - 6 x USB 3.1 Gen 1 ports (4 ports on the back panel, 2 ports available through the internal USB header) - 4 x USB 2.0/1.1 ports (2 ports on the back panel, 2 ports available through the internal USB header)

① Only for B360N WIFI.

② Only for B360N GSM.

	Internal Connectors	<ul style="list-style-type: none"> ◆ 1 x 24-pin ATX main power connector ◆ 1 x 4-pin ATX 12V power connector ◆ 4 x SATA 6Gb/s connectors ◆ 1 x M.2 Socket 3 connector ◆ 1 x CPU fan header ◆ 2 x system fan headers ◆ 1 x RGB LED strip header ◆ 1 x front panel header ◆ 1 x front panel audio header ◆ 1 x S/PDIF Out header ◆ 1 x USB 3.1 Gen 1 header ◆ 1 x USB 2.0/1.1 header ◆ 4 x serial port headers ◆ 1 x speaker header ◆ 1 x Clear CMOS jumper ◆ 1 x chassis intrusion header
	Back Panel Connectors	<ul style="list-style-type: none"> ◆ 1 x PS/2 keyboard/mouse port ◆ 2 x HDMI ports ◆ 4 x USB 3.1 Gen 1 ports ◆ 2 x USB 2.0/1.1 ports ◆ 2 x RJ-45 ports ◆ 2 x SMA antenna connectors (2T2R) ◆ 6 x audio jacks
	I/O Controller	<ul style="list-style-type: none"> ◆ iTE® I/O Controller Chip
	Hardware Monitor	<ul style="list-style-type: none"> ◆ Voltage detection ◆ Temperature detection ◆ Fan speed detection ◆ Overheating warning ◆ Fan fail warning ◆ Fan speed control <p style="margin-left: 40px;">* Whether the fan speed control function is supported will depend on the cooler you install.</p>
	BIOS	<ul style="list-style-type: none"> ◆ 2 x 128 Mbit flash ◆ Use of licensed AMI UEFI BIOS ◆ Support for DualBIOS™ ◆ PnP 1.0a, DMI 2.7, WfM 2.0, SM BIOS 2.7, ACPI 5.0

 Unique Features	<ul style="list-style-type: none"> ◆ Support for APP Center <ul style="list-style-type: none"> * Available applications in APP Center may vary by motherboard model. Supported functions of each application may also vary depending on motherboard specifications. - 3D OSD - @BIOS - AutoGreen - Cloud Station - EasyTune - Fast Boot - Game Boost - ON/OFF Charge - Platform Power Management - RGB Fusion - Smart Backup - Smart Keyboard - Smart TimeLock - Smart HUD - System Information Viewer - USB Blocker - V-Tuner ◆ Support for Q-Flash ◆ Support for Xpress Install
 Bundled Software	<ul style="list-style-type: none"> ◆ Norton® Internet Security (OEM version) ◆ cFosSpeed
 Operating System	<ul style="list-style-type: none"> ◆ Support for Windows 10 64-bit
 Form Factor	<ul style="list-style-type: none"> ◆ Mini-ITX Form Factor; 17.0cm x 17.0cm

* GIGABYTE reserves the right to make any changes to the product specifications and product-related information without prior notice.

B360N WIFI



B360N GSM



Please visit GIGABYTE's website for support lists of CPU, memory modules, SSDs, and M.2 devices.



Please visit the **SupportUtility List** page on GIGABYTE's website to download the latest version of apps.

1-3 Installing the CPU



Read the following guidelines before you begin to install the CPU:

- Make sure that the motherboard supports the CPU.
(Go to GIGABYTE's website for the latest CPU support list.)
- Always turn off the computer and unplug the power cord from the power outlet before installing the CPU to prevent hardware damage.
- Locate the pin one of the CPU. The CPU cannot be inserted if oriented incorrectly. (Or you may locate the notches on both sides of the CPU and alignment keys on the CPU socket.)
- Apply an even and thin layer of thermal grease on the surface of the CPU.
- Do not turn on the computer if the CPU cooler is not installed, otherwise overheating and damage of the CPU may occur.
- Set the CPU host frequency in accordance with the CPU specifications. It is not recommended that the system bus frequency be set beyond hardware specifications since it does not meet the standard requirements for the peripherals. If you wish to set the frequency beyond the standard specifications, please do so according to your hardware specifications including the CPU, graphics card, memory, hard drive, etc.

Installing the CPU

Locate the alignment keys on the motherboard CPU socket and the notches on the CPU.

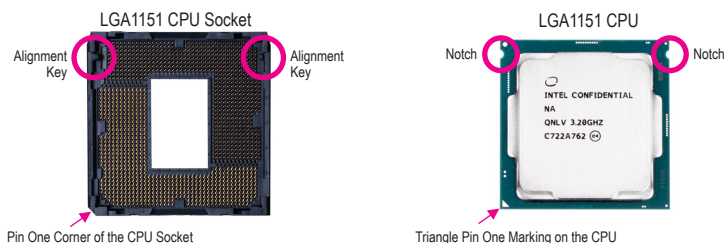

Do not remove the CPU socket cover before inserting the CPU. It may pop off from the load plate automatically during the process of re-engaging the lever after you insert the CPU.

1-4 Installing the Memory



Read the following guidelines before you begin to install the memory:

- Make sure that the motherboard supports the memory. It is recommended that memory of the same capacity, brand, speed, and chips be used.
(Go to GIGABYTE's website for the latest supported memory speeds and memory modules.)
- Always turn off the computer and unplug the power cord from the power outlet before installing the memory to prevent hardware damage.
- Memory modules have a foolproof design. A memory module can be installed in only one direction. If you are unable to insert the memory, switch the direction.

Dual Channel Memory Configuration

This motherboard provides two memory sockets and supports Dual Channel Technology. After the memory is installed, the BIOS will automatically detect the specifications and capacity of the memory. Enabling Dual Channel memory mode will double the original memory bandwidth.



Please visit GIGABYTE's website for details on hardware installation.

The two memory sockets are divided into two channels and each channel has one memory socket as following:

- ▶▶ Channel A: DDR4_1
- ▶▶ Channel B: DDR4_2

Due to CPU limitations, read the following guidelines before installing the memory in Dual Channel mode.

1. Dual Channel mode cannot be enabled if only one memory module is installed.
2. When enabling Dual Channel mode with two memory modules, it is recommended that memory of the same capacity, brand, speed, and chips be used for optimum performance.

1-5 Installing an Expansion Card



Read the following guidelines before you begin to install an expansion card:

- Make sure the motherboard supports the expansion card. Carefully read the manual that came with your expansion card.
- Always turn off the computer and unplug the power cord from the power outlet before installing an expansion card to prevent hardware damage.

1-6 Back Panel Connectors

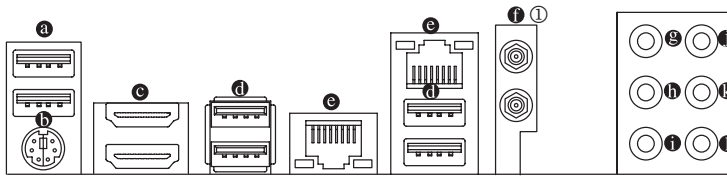

a USB 2.0/1.1 Port

The USB port supports the USB 2.0/1.1 specification. Use this port for USB devices.

b PS/2 Keyboard/Mouse Port

Use this port to connect a PS/2 mouse or keyboard.

c HDMI Port

HDMI™ The HDMI port supports HDCP 2.2 and Dolby TrueHD and DTS HD Master Audio formats. It also supports up to 192KHz/16bit 8-channel LPCM audio output. You can use this port to connect your HDMI-supported monitor. The maximum supported resolution is 4096x2160@30 Hz, but the actual resolutions supported are dependent on the monitor being used.



After installing the HDMI device, make sure to set the default sound playback device to HDMI. (The item name may differ depending on your operating system.)

f USB 3.1 Gen 1 Port

The USB 3.1 Gen 1 port supports the USB 3.1 Gen 1 specification and is compatible to the USB 2.0 specification. Use this port for USB devices.

e RJ-45 LAN Port

The Gigabit Ethernet LAN port provides Internet connection at up to 1 Gbps data rate. The following describes the states of the LAN port LEDs.

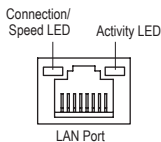

Connection/Speed LED:

State	Description
Orange	1 Gbps data rate
Green	100 Mbps data rate
Off	10 Mbps data rate

Activity LED:

State	Description
Blinking	Data transmission or receiving is occurring
On	No data transmission or receiving is occurring

① Only for B360N WIFI.

❶ **SMA Antenna Connectors (2T2R)** ①

Use this connector to connect an antenna.



Tighten the antenna cables to the antenna connectors and then move the antenna to a place where the signal is good.

❷ **Center/Subwoofer Speaker Out (Orange)**

Use this audio jack to connect center/subwoofer speakers.

❸ **Rear Speaker Out (Black)**

Use this audio jack to connect rear speakers.

❹ **Side Speaker Out (Gray)**

Use this audio jack to connect side speakers.

❺ **Line In (Blue)**

The line in jack. Use this audio jack for line in devices such as an optical drive, walkman, etc.

❻ **Line Out/Front Speaker Out (Green)**

The line out jack.

❼ **Mic In (Pink)**

The Mic in jack.

Audio Jack Configurations:

Jack	Headphone/ 2-channel	4-channel	6-channel	8-channel
❷ Center/Subwoofer Speaker Out			✓	✓
❸ Rear Speaker Out		✓	✓	✓
❹ Side Speaker Out				✓
❺ Line In				
❻ Line Out/Front Speaker Out	✓	✓	✓	✓
❼ Mic In				



- When removing the cable connected to a back panel connector, first remove the cable from your device and then remove it from the motherboard.
- When removing the cable, pull it straight out from the connector. Do not rock it side to side to prevent an electrical short inside the cable connector.

① Only for B360N WIFI.



Please visit GIGABYTE's website for details on configuring the audio software.

1-7 Internal Connectors

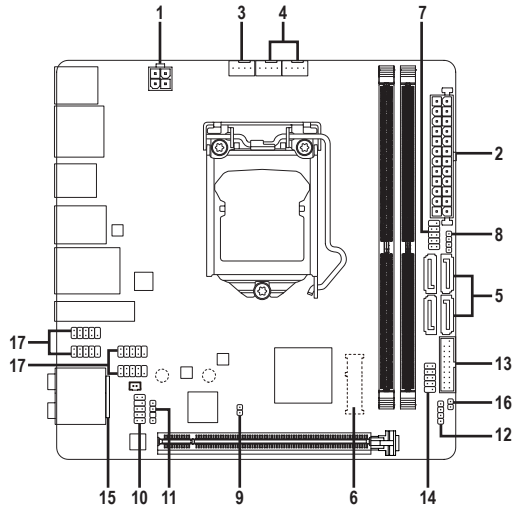

1) ATX_12V	10) F_AUDIO
2) ATX	11) SPDIF_O
3) CPU_FAN	12) LED_C
4) SYS_FAN1/SYS_FAN2	13) F_USB30
5) SATA3 0/1/2/3	14) F_USB
6) M.2 <small>(Note)</small>	15) BAT
7) F_PANEL	16) CLR_CMOS
8) SPEAKER	17) COM1/COM2/COM3/COM4
9) CI	

(Note) The connector is on the back of the motherboard.



Read the following guidelines before connecting external devices:

- First make sure your devices are compliant with the connectors you wish to connect.
- Before installing the devices, be sure to turn off the devices and your computer. Unplug the power cord from the power outlet to prevent damage to the devices.
- After installing the device and before turning on the computer, make sure the device cable has been securely attached to the connector on the motherboard.

1/2) ATX_12V/ATX (2x2 12V Power Connector and 2x12 Main Power Connector)

With the use of the power connector, the power supply can supply enough stable power to all the components on the motherboard. Before connecting the power connector, first make sure the power supply is turned off and all devices are properly installed. The power connector possesses a foolproof design. Connect the power supply cable to the power connector in the correct orientation.

The 12V power connector mainly supplies power to the CPU. If the 12V power connector is not connected, the computer will not start.



To meet expansion requirements, it is recommended that a power supply that can withstand high power consumption be used (500W or greater). If a power supply is used that does not provide the required power, the result can lead to an unstable or unbootable system.

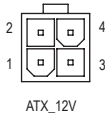

ATX_12V:

Pin No.	Definition
1	GND
2	GND
3	+12V
4	+12V

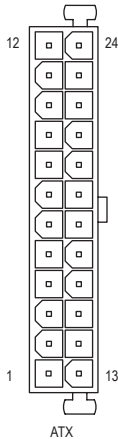

ATX:

Pin No.	Definition	Pin No.	Definition
1	3.3V	13	3.3V
2	3.3V	14	-12V
3	GND	15	GND
4	+5V	16	PS_ON (soft On/Off)
5	GND	17	GND
6	+5V	18	GND
7	GND	19	GND
8	Power Good	20	NC
9	5VSB (stand by +5V)	21	+5V
10	+12V	22	+5V
11	+12V (Only for 2x12-pin ATX)	23	+5V (Only for 2x12-pin ATX)
12	3.3V (Only for 2x12-pin ATX)	24	GND (Only for 2x12-pin ATX)

3/4) CPU_FAN/SYS_FAN1/SYS_FAN2 (Fan Headers)

All fan headers on this motherboard are 4-pin. Most fan headers possess a foolproof insertion design. When connecting a fan cable, be sure to connect it in the correct orientation (the black connector wire is the ground wire). The speed control function requires the use of a fan with fan speed control design. For optimum heat dissipation, it is recommended that a system fan be installed inside the chassis.



Pin No.	Definition
1	GND
2	Voltage Speed Control
3	Sense
4	PWM Speed Control



- Be sure to connect fan cables to the fan headers to prevent your CPU and system from overheating. Overheating may result in damage to the CPU or the system may hang.
- These fan headers are not configuration jumper blocks. Do not place a jumper cap on the headers.

5) SATA3 0/1/2/3 (SATA 6Gb/s Connectors)

The SATA connectors conform to SATA 6Gb/s standard and are compatible with SATA 3Gb/s and SATA 1.5Gb/s standard. Each SATA connector supports a single SATA device.

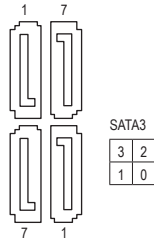

Pin No.	Definition
1	GND
2	TXP
3	TXN
4	GND
5	RXN
6	RXP
7	GND



To enable hot-plugging for the SATA ports, refer to Chapter 2, "BIOS Setup," "Peripherals\SATA And RST Configuration," for more information.

6) M.2 (M.2 Socket 3 Connector) ^(Note)

The M.2 connector supports M.2 SATA SSDs and M.2 PCIe SSDs.



Follow the steps below to correctly install an M.2 SSD in the M.2 connector.

Step 1:

Use a screw driver to unfasten the screw and standoff from the motherboard. Locate the proper mounting hole for the M.2 SSD to be installed and then screw the standoff first.

Step 2:

Slide the M.2 SSD into the connector at an angle.

Step 3:

Press the M.2 SSD down and then secure it with the screw.



Select the proper hole for the M.2 SSD to be installed and refasten the screw and standoff.

(Note) The connector is on the back of the motherboard.

7) F_PANEL (Front Panel Header)

Connect the power switch, reset switch, and system status indicator on the chassis to this header according to the pin assignments below. Note the positive and negative pins before connecting the cables.

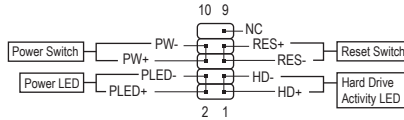

- **PLED** (Power LED, Yellow):

System Status	LED
S0	On
S3/S4/S5	Off

Connects to the power status indicator on the chassis front panel. The LED is on when the system is operating. The LED is off when the system is in S3/S4 sleep state or powered off (S5).

- **PW** (Power Switch, Red):

Connects to the power switch on the chassis front panel. You may configure the way to turn off your system using the power switch (refer to Chapter 2, "BIOS Setup," "Power," for more information).

- **HD** (Hard Drive Activity LED, Blue):

Connects to the hard drive activity LED on the chassis front panel. The LED is on when the hard drive is reading or writing data.

- **RES** (Reset Switch, Green):

Connects to the reset switch on the chassis front panel. Press the reset switch to restart the computer if the computer freezes and fails to perform a normal restart.

- **NC** (Purple): No connection.



The front panel design may differ by chassis. A front panel module mainly consists of power switch, reset switch, power LED, hard drive activity LED and etc. When connecting your chassis front panel module to this header, make sure the wire assignments and the pin assignments are matched correctly.

8) SPEAKER (Speaker Header)

Connects to the speaker on the chassis front panel. The system reports system startup status by issuing a beep code. One single short beep will be heard if no problem is detected at system startup.



Pin No.	Definition
1	VCC
2	NC
3	NC
4	SPK-

9) CI (Chassis Intrusion Header)

This motherboard provides a chassis detection feature that detects if the chassis cover has been removed. This function requires a chassis with chassis intrusion detection design.



Pin No.	Definition
1	Signal
2	GND

10) F_AUDIO (Front Panel Audio Header)

The front panel audio header supports High Definition audio (HD). You may connect your chassis front panel audio module to this header. Make sure the wire assignments of the module connector match the pin assignments of the motherboard header. Incorrect connection between the module connector and the motherboard header will make the device unable to work or even damage it.



Pin No.	Definition	Pin No.	Definition
1	MIC2_L	6	Sense
2	GND	7	FAUDIO_JD
3	MIC2_R	8	No Pin
4	NC	9	LINE2_L
5	LINE2_R	10	Sense



Some chassis provide a front panel audio module that has separated connectors on each wire instead of a single plug. For information about connecting the front panel audio module that has different wire assignments, please contact the chassis manufacturer.

11) SPDIF_O (S/PDIF Out Header)

This header supports digital S/PDIF Out and connects a S/PDIF digital audio cable (provided by expansion cards) for digital audio output from your motherboard to certain expansion cards like graphics cards and sound cards. For example, some graphics cards may require you to use a S/PDIF digital audio cable for digital audio output from your motherboard to your graphics card if you wish to connect an HDMI display to the graphics card and have digital audio output from the HDMI display at the same time. For information about connecting the S/PDIF digital audio cable, carefully read the manual for your expansion card.



Pin No.	Definition
1	5VDUAL
2	No Pin
3	SPDIFO
4	GND

12) LED_C (RGB LED Strip Header)

The header can be used to connect a standard 5050 RGB LED strip (12V/G/R/B), with maximum power rating of 2A (12V) and maximum length of 2m.

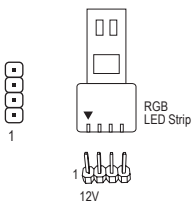

Pin No.	Definition
1	12V
2	G
3	R
4	B

Connect your RGB LED strip to the header. The power pin (marked with a triangle on the plug) of the LED strip must be connected to Pin 1 (12V) of this header. Incorrect connection may lead to the damage of the LED strip.



For how to turn on/off the lights of the LED strip, refer to the instructions on in Chapter 2, "BIOS Setup," "Peripherals."



Before installing the devices, be sure to turn off the devices and your computer. Unplug the power cord from the power outlet to prevent damage to the devices.

13) F_USB30 (USB 3.1 Gen 1 Header)

The header conforms to USB 3.1 Gen 1 and USB 2.0 specification and can provide two USB ports. For purchasing the optional 3.5" front panel that provides two USB 3.1 Gen 1 ports, please contact the local dealer.

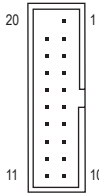

Pin No.	Definition	Pin No.	Definition
1	VBUS	11	D2+
2	SSRX1-	12	D2-
3	SSRX1+	13	GND
4	GND	14	SSTX2+
5	SSTX1-	15	SSTX2-
6	SSTX1+	16	GND
7	GND	17	SSRX2+
8	D1-	18	SSRX2-
9	D1+	19	VBUS
10	NC	20	No Pin

14) F_USB (USB 2.0/1.1 Header)

The header conforms to USB 2.0/1.1 specification. Each USB header can provide two USB ports via an optional USB bracket. For purchasing the optional USB bracket, please contact the local dealer.



Pin No.	Definition	Pin No.	Definition
1	Power (5V)	6	USB DY+
2	Power (5V)	7	GND
3	USB DX-	8	GND
4	USB DY-	9	No Pin
5	USB DX+	10	NC



- Do not plug the IEEE 1394 bracket (2x5-pin) cable into the USB 2.0/1.1 header.
- Prior to installing the USB bracket, be sure to turn off your computer and unplug the power cord from the power outlet to prevent damage to the USB bracket.

15) BAT (Battery)

The battery provides power to keep the values (such as BIOS configurations, date, and time information) in the CMOS when the computer is turned off. Replace the battery when the battery voltage drops to a low level, or the CMOS values may not be accurate or may be lost.

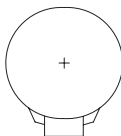

1 (+) 2 (-)

Pin No.	Definition
1 (+)	RTC Power
2 (-)	GND

You may clear the CMOS values by removing the battery cable:

1. Turn off your computer and unplug the power cord.
2. Unplug the the battery cable from the battery cable header and wait for one minute.
3. Replace the battery.
4. Plug in the power cord and restart your computer.



- Always turn off your computer and unplug the power cord before replacing the battery.
- Replace the battery with an equivalent one. Damage to your devices may occur if the battery is replaced with an incorrect model.
- Contact the place of purchase or local dealer if you are not able to replace the battery by yourself or uncertain about the battery model.
- When installing the battery, note the orientation of the positive side (+) and the negative side (-) of the battery (the positive side should face up).
- Used batteries must be handled in accordance with local environmental regulations.

16) CLR_CMOS (Clear CMOS Jumper)

Use this jumper to clear the BIOS configuration and reset the CMOS values to factory defaults. To clear the CMOS values, use a metal object like a screwdriver to touch the two pins for a few seconds.



Open: Normal



Short: Clear CMOS Values



- Always turn off your computer and unplug the power cord from the power outlet before clearing the CMOS values.
- After system restart, go to BIOS Setup to load factory defaults (select Load Optimized Defaults) or manually configure the BIOS settings (refer to Chapter 2, "BIOS Setup," for BIOS configurations).

17) COM1/COM2/COM3/COM4 (Serial Port Headers)

The COM header can provide one serial port via an optional COM port cable. For purchasing the optional COM port cable, please contact the local dealer.

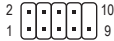

Pin No.	Definition	Pin No.	Definition
1	NDCD-	6	NDSR-
2	NSIN	7	NRTS-
3	NSOUT	8	NCTS-
4	NDTR-	9	NR1-
5	GND	10	No Pin

Chapter 2 BIOS Setup

BIOS (Basic Input and Output System) records hardware parameters of the system in the CMOS on the motherboard. Its major functions include conducting the Power-On Self-Test (POST) during system startup, saving system parameters and loading operating system, etc. BIOS includes a BIOS Setup program that allows the user to modify basic system configuration settings or to activate certain system features.

When the power is turned off, the battery on the motherboard supplies the necessary power to the CMOS to keep the configuration values in the CMOS.

To access the BIOS Setup program, press the <Delete> key during the POST when the power is turned on.

To upgrade the BIOS, use either the GIGABYTE Q-Flash or @BIOS utility.

- Q-Flash allows the user to quickly and easily upgrade or back up BIOS without entering the operating system.
- @BIOS is a Windows-based utility that searches and downloads the latest version of BIOS from the Internet and updates the BIOS.



- Because BIOS flashing is potentially risky, if you do not encounter problems using the current version of BIOS, it is recommended that you not flash the BIOS. To flash the BIOS, do it with caution. Inadequate BIOS flashing may result in system malfunction.
- It is recommended that you not alter the default settings (unless you need to) to prevent system instability or other unexpected results. Inadequately altering the settings may result in system's failure to boot. If this occurs, try to clear the CMOS values and reset the board to default values. (Refer to the "Load Optimized Defaults" section in this chapter or introductions of the battery/clear CMOS jumper in Chapter 1 for how to clear the CMOS values.)

2-1 Startup Screen

The following startup Logo screen will appear when the computer boots.

(Sample BIOS Version: B360N WIFI, T0d)



There are two different BIOS modes as follows and you can use the <F2> key to switch between the two modes. The Classic Setup mode provides detailed BIOS settings. You can press the arrow keys on your keyboard to move among the items and press <Enter> to accept or enter a sub-menu. Or you can use your mouse to select the item you want. Easy Mode allows users to quickly view their current system information or to make adjustments for optimum performance. In Easy Mode, you can use your mouse to move through configuration items.



- When the system is not stable as usual, select the **Load Optimized Defaults** item to set your system to its defaults.
- The BIOS Setup menus described in this chapter are for reference only and may differ by BIOS version.

2-2 The Main Menu

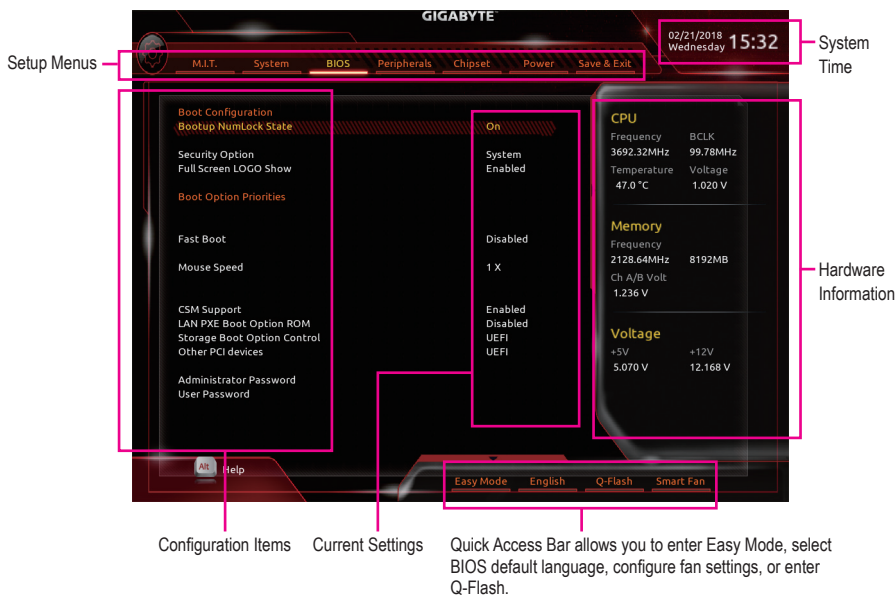

Classic Setup Function Keys

<←><→>	Move the selection bar to select a setup menu
<↑><↓>	Move the selection bar to select an configuration item on a menu
<Enter>	Execute command or enter a menu
<+>/<Page Up>	Increase the numeric value or make changes
<->/<Page Down>	Decrease the numeric value or make changes
<F1>	Show descriptions of the function keys
<F2>	Switch to Easy Mode
<F5>	Restore the previous BIOS settings for the current submenus
<F7>	Load the Optimized BIOS default settings for the current submenus
<F8>	Access the Q-Flash utility
<F9>	Display system information
<F10>	Save all the changes and exit the BIOS Setup program
<F12>	Capture the current screen as an image and save it to your USB drive
<Esc>	Main Menu: Exit the BIOS Setup program Submenus: Exit current submenu

2-3 M.I.T.



Whether the system will work stably with the overclock/overvoltage settings you made is dependent on your overall system configurations. Incorrectly doing overclock/overvoltage may result in damage to CPU, chipset, or memory and reduce the useful life of these components. This page is for advanced users only and we recommend you not to alter the default settings to prevent system instability or other unexpected results. (Inadequately altering the settings may result in system's failure to boot. If this occurs, clear the CMOS values and reset the board to default values.)

▶ **Advanced Frequency Settings**

☞ **Host Clock Value**

Displays the current operating Host Clock frequency.

☞ **Graphics Slice Ratio** (Note)

Allows you to set the Graphics Slice Ratio.

☞ **Graphics UnSlice Ratio** (Note)

Allows you to set the Graphics UnSlice Ratio.

☞ **CPU Clock Ratio**

Allows you to alter the clock ratio for the installed CPU. The adjustable range is dependent on the CPU being installed.

☞ **CPU Frequency**

Displays the current operating CPU frequency.

☞ **FCLK Frequency for Early Power On**

Allows you to set the FCLK frequency. Options are: Normal(800Mhz), 1GHz, 400MHz. (Default: 1GHz)

▶ **Advanced CPU Core Settings**

☞ **CPU Clock Ratio, CPU Frequency, FCLK Frequency for Early Power On**

The settings above are synchronous to those under the same items on the **Advanced Frequency Settings** menu.

(Note) This item is present only when you install a CPU that supports this feature. For more information about Intel® CPUs' unique features, please visit Intel's website.

- ☞ **AVX Offset** ^(Note)
AVX offset is the negative offset of AVX ratio.
- ☞ **Uncore Ratio**
Allows you to set the CPU Uncore ratio. The adjustable range is dependent on the CPU being used.
- ☞ **Uncore Frequency**
Displays the current CPU Uncore frequency.
- ☞ **CPU Flex Ratio Override**
Enables or disables the CPU Flex Ratio. The maximum CPU clock ratio will be based on the **CPU Flex Ratio Settings** value if **CPU Clock Ratio** is set to **Auto**. (Default: Disabled)
- ☞ **CPU Flex Ratio Settings**
Allows you to set the CPU Flex Ratio. The adjustable range may vary by CPU.
- ☞ **Intel(R) Turbo Boost Technology** ^(Note)
Allows you to determine whether to enable the Intel® CPU Turbo Boost technology. **Auto** lets the BIOS automatically configure this setting. (Default: Auto)
- ☞ **Turbo Ratio** ^(Note)
Allows you to set the CPU Turbo ratios for different number of active cores. **Auto** sets the CPU Turbo ratios according to the CPU specifications. (Default: Auto)
- ☞ **Power Limit TDP (Watts) / Power Limit Time**
Allows you to set the power limit for CPU Turbo mode and how long it takes to operate at the specified power limit. If the specified value is exceeded, the CPU will automatically reduce the core frequency in order to reduce the power. **Auto** sets the current limit according to the CPU specifications. (Default: Auto)
- ☞ **Core Current Limit (Amps)**
Allows you to set a current limit for CPU Turbo mode. When the CPU current exceeds the specified current limit, the CPU will automatically reduce the core frequency in order to reduce the current. **Auto** sets the power limit according to the CPU specifications. (Default: Auto)
- ☞ **Turbo Per Core Limit Control** ^(Note)
Allows you to control each CPU core limit separately. (Default: Auto)
- ☞ **No. of CPU Cores Enabled** ^(Note)
Allows you to select the number of CPU cores to enable in an Intel® multi-core CPU (the number of CPU cores may vary by CPU). **Auto** lets the BIOS automatically configure this setting. (Default: Auto)
- ☞ **Hyper-Threading Technology** ^(Note)
Allows you to determine whether to enable multi-threading technology when using an Intel® CPU that supports this function. This feature only works for operating systems that support multi-processor mode. **Auto** lets the BIOS automatically configure this setting. (Default: Auto)
- ☞ **Intel(R) Speed Shift Technology (Intel® Speed Shift Technology)** ^(Note)
Enables or disables Intel® Speed Shift Technology. Enabling this feature allows the processor to ramp up its operating frequency more quickly and then improves the system responsiveness. (Default: Disabled)
- ☞ **CPU Enhanced Halt (C1E)** ^(Note)
Enables or disables Intel® CPU Enhanced Halt (C1E) function, a CPU power-saving function in system halt state. When enabled, the CPU core frequency and voltage will be reduced during system halt state to decrease power consumption. **Auto** lets the BIOS automatically configure this setting. (Default: Auto)

(Note) This item is present only when you install a CPU that supports this feature. For more information about Intel® CPUs' unique features, please visit Intel's website.

- ☞ **C3 State Support** ^(Note)
 Allows you to determine whether to let the CPU enter C3 mode in system halt state. When enabled, the CPU core frequency and voltage will be reduced during system halt state to decrease power consumption. The C3 state is a more enhanced power-saving state than C1. **Auto** lets the BIOS automatically configure this setting. (Default: Auto)
- ☞ **C6/C7 State Support** ^(Note)
 Allows you to determine whether to let the CPU enter C6/C7 mode in system halt state. When enabled, the CPU core frequency and voltage will be reduced during system halt state to decrease power consumption. The C6/C7 state is a more enhanced power-saving state than C3. **Auto** lets the BIOS automatically configure this setting. (Default: Auto)
- ☞ **C8 State Support** ^(Note)
 Allows you to determine whether to let the CPU enter C8 mode in system halt state. When enabled, the CPU core frequency and voltage will be reduced during system halt state to decrease power consumption. The C8 state is a more enhanced power-saving state than C6/C7. **Auto** lets the BIOS automatically configure this setting. (Default: Auto)
- ☞ **C10 State Support** ^(Note)
 Allows you to determine whether to let the CPU enter C10 mode in system halt state. When enabled, the CPU core frequency and voltage will be reduced during system halt state to decrease power consumption. The C10 state is a more enhanced power-saving state than C8. **Auto** lets the BIOS automatically configure this setting. (Default: Auto)
- ☞ **Package C State Limit** ^(Note)
 Allows you to specify the C-state limit for the processor. **Auto** lets the BIOS automatically configure this setting. (Default: Auto)
- ☞ **CPU Thermal Monitor** ^(Note)
 Enables or disables Intel® Thermal Monitor function, a CPU overheating protection function. When enabled, the CPU core frequency and voltage will be reduced when the CPU is overheated. **Auto** lets the BIOS automatically configure this setting. (Default: Auto)
- ☞ **Ring to Core offset (Down Bin)**
 Allows you to determine whether to disable the CPU Ring ratio auto-down function. **Auto** lets the BIOS automatically configure this setting. (Default: Auto)
- ☞ **CPU EIST Function** ^(Note)
 Enables or disables Enhanced Intel® Speed Step Technology (EIST). Depending on CPU loading, Intel® EIST technology can dynamically and effectively lower the CPU voltage and core frequency to decrease average power consumption and heat production. **Auto** lets the BIOS automatically configure this setting. (Default: Auto)
- ☞ **Race To Halt (RTH)** ^(Note)/**Energy Efficient Turbo** ^(Note)
 Enables or disables the CPU power saving related settings.
- ☞ **Voltage Optimization**
 Allows you to determine whether to enable voltage optimization to reduce power consumption. (Default: Disabled)
- ☞ **Hardware Prefetcher**
 Allows you to determine whether to enable hardware prefetcher to prefetch data and instructions from the memory into the cache. (Default: Enabled)
- ☞ **Adjacent Cache Line Prefetch**
 Allows you to determine whether to enable the adjacent cache line prefetch mechanism that lets the processor retrieve the requested cache line as well as the subsequent cache line. (Default: Enabled)

(Note) This item is present only when you install a CPU that supports this feature. For more information about Intel® CPUs' unique features, please visit Intel's website.

- ☞ **Extreme Memory Profile (X.M.P.)** ^(Note)
 Allows the BIOS to read the SPD data on XMP memory module(s) to enhance memory performance when enabled.

 - ▶▶ Disabled Disables this function. (Default)
 - ▶▶ Profile1 Uses Profile 1 settings.
 - ▶▶ Profile2 ^(Note) Uses Profile 2 settings.
- ☞ **System Memory Multiplier**
 Allows you to set the system memory multiplier. **Auto** sets memory multiplier according to memory SPD data. (Default: Auto)
- ☞ **Memory Ref Clock**
 Allows you to manually adjust the memory reference clock. (Default: Auto)
- ☞ **Memory Odd Ratio (100/133 or 200/266)**
Enabled allows Qclk to run in odd frequency. (Default: Auto)
- ☞ **Memory Frequency (MHz)**
 The first memory frequency value is the normal operating frequency of the memory being used; the second is the memory frequency that is automatically adjusted according to the **System Memory Multiplier** settings.
- ▶ **Advanced Memory Settings**

 - ☞ **Extreme Memory Profile (X.M.P.)** ^(Note), **System Memory Multiplier**, **Memory Ref Clock**, **Memory Odd Ratio (100/133 or 200/266)**, **Memory Frequency(MHz)**
 The settings above are synchronous to those under the same items on the **Advanced Frequency Settings** menu.
 - ☞ **Memory Boot Mode** ^(Note)
 Provides memory detection and training methods.

 - ▶▶ Auto Lets the BIOS automatically configure this setting. (Default)
 - ▶▶ Normal The BIOS automatically performs memory training. Please note that if the system becomes unstable or unbootable, try to clear the CMOS values and reset the board to default values. (Refer to the introductions of the battery/clear CMOS jumper in Chapter 1 for how to clear the CMOS values.)
 - ▶▶ Enable Fast Boot Skip memory detection and training in some specific criteria for faster memory boot.
 - ▶▶ Disable Fast Boot Detect and train memory at every single boot.
 - ☞ **Realtime Memory Timing**
 Allows you to fine-tune memory timings after the BIOS stage. (Default: Auto)
 - ☞ **Memory Enhancement Settings**
 Provides several memory performance enhancement settings: Normal (basic performance), Relax OC, Enhanced Stability, and Enhanced Performance. (Default: Normal)
 - ☞ **Memory Timing Mode**
Manual and **Advanced Manual** allows the **Memory Multiplier Tweaker**, **Channel Interleaving**, **Rank Interleaving**, and memory timing settings below to be configurable. Options are: Auto (default), Manual, Advanced Manual.
 - ☞ **Profile DDR Voltage**
 When using a non-XMP memory module or **Extreme Memory Profile (X.M.P.)** is set to **Disabled**, the value is displayed according to your memory specification. When **Extreme Memory Profile (X.M.P.)** is set to **Profile1** or **Profile2**, the value is displayed according to the SPD data on the XMP memory.

(Note) This item is present only when you install a CPU and a memory module that support this feature.

☞ **Memory Multiplier Tweaker**

Provides different levels of memory auto-tuning. (Default: Auto)

☞ **Channel Interleaving**

Enables or disables memory channel interleaving. **Enabled** allows the system to simultaneously access different channels of the memory to increase memory performance and stability. **Auto** lets the BIOS automatically configure this setting. (Default: Auto)

☞ **Rank Interleaving**

Enables or disables memory rank interleaving. **Enabled** allows the system to simultaneously access different ranks of the memory to increase memory performance and stability. **Auto** lets the BIOS automatically configure this setting. (Default: Auto)

▶ **Channel A/B Memory Sub Timings**

This sub-menu provides memory timing settings for each channel of memory. The respective timing setting screens are configurable only when **Memory Timing Mode** is set to **Manual** or **Advanced Manual**. Note: Your system may become unstable or fail to boot after you make changes on the memory timings. If this occurs, please reset the board to default values by loading optimized defaults or clearing the CMOS values.

▶ **Advanced Voltage Settings**

▶ **Advanced Power Settings**

☞ **CPU Vcore Loadline Calibration**

Allows you to configure Load-Line Calibration for the CPU Vcore voltage. Selecting a higher level keeps the CPU Vcore voltage more consistent with what is set in BIOS under heavy load. **Auto** lets the BIOS automatically configure this setting and sets the voltage following Intel's specifications. (Default: Auto)

▶ **CPU Core Voltage Control**

This section provides CPU voltage control options.

▶ **Chipset Voltage Control**

This section provides Chipset voltage control options.

▶ **DRAM Voltage Control**

This section provides memory voltage control options.

▶ **Internal VR Control**

This section provides VR voltage control options.

▶ **PC Health Status**

☞ **Reset Case Open Status**

- ▶ Disabled Keeps or clears the record of previous chassis intrusion status. (Default)
- ▶ Enabled Clears the record of previous chassis intrusion status and the **Case Open** field will show "No" at next boot.

☞ **Case Open**

Displays the detection status of the chassis intrusion detection device attached to the motherboard **CI header**. If the system chassis cover is removed, this field will show "Yes", otherwise it will show "No". To clear the chassis intrusion status record, set **Reset Case Open Status** to **Enabled**, save the settings to the CMOS, and then restart your system.

- ☞ **CPU Vcore/CPU VCCSA/DRAM Channel A/B Voltage/+3.3V/+5V/+12V/CPU VAXG**
Displays the current system voltages.
- ▶ **Miscellaneous Settings**
- ☞ **Max Link Speed**
Allows you to set the operation mode of the PCI Express slots to Gen 1, Gen 2, or Gen 3. Actual operation mode is subject to the hardware specification of each slot. **Auto** lets the BIOS automatically configure this setting. (Default: Auto)
- ☞ **3DMark01 Enhancement**
Allows you to determine whether to enhance some legacy benchmark performance. (Default: Disabled)
- ▶ **Smart Fan 5 Settings**
- ☞ **Monitor**
Allows you to select a target to monitor and to make further adjustment. (Default: CPU FAN)
- ☞ **Fan Speed Control**
Allows you to determine whether to enable the fan speed control function and adjust the fan speed.
 - ▶▶ Normal Allows the fan to run at different speeds according to the temperature. You can adjust the fan speed with System Information Viewer based on your system requirements. (Default)
 - ▶▶ Silent Allows the fan to run at slow speeds.
 - ▶▶ Manual Allows you to control the fan speed in the curve graph.
 - ▶▶ Full Speed Allows the fan to run at full speeds.
- ☞ **Fan Control Use Temperature Input**
Allows you to select the reference temperature for fan speed control.
- ☞ **Temperature Interval**
Allows you to select the temperature interval for fan speed change.
- ☞ **Fan Control Mode**
 - ▶▶ Auto Lets the BIOS automatically detect the type of fan installed and sets the optimal control mode. (Default)
 - ▶▶ Voltage Voltage mode is recommended for a 3-pin fan.
 - ▶▶ PWM PWM mode is recommended for a 4-pin fan.
- ☞ **Fan Stop**
Enables or disables the fan stop function. You can set the temperature limit using the temperature curve. The fan stops operation when the temperature is lower than the limit. (Default: Disabled)
- ☞ **Temperature**
Displays the current temperature of the selected target area.
- ☞ **Fan Speed**
Displays current fan speeds.
- ☞ **Temperature Warning Control**
Sets the warning threshold for temperature. When temperature exceeds the threshold, BIOS will emit warning sound. Options are: Disabled (default), 60°C/140°F, 70°C/158°F, 80°C/176°F, 90°C/194°F.
- ☞ **Fan Fail Warning**
Allows the system to emit warning sound if the fan is not connected or fails. Check the fan condition or fan connection when this occurs. (Default: Disabled)

2-4 System



This section provides information on your motherboard model and BIOS version. You can also select the default language used by the BIOS and manually set the system time.

☞ Access Level

Displays the current access level depending on the type of password protection used. (If no password is set, the default will display as **Administrator**.) The Administrator level allows you to make changes to all BIOS settings; the User level only allows you to make changes to certain BIOS settings but not all.

☞ System Language

Selects the default language used by the BIOS.

☞ System Date

Sets the system date. The date format is week (read-only), month, date, and year. Use <Enter> to switch between the Month, Date, and Year fields and use the <Page Up> or <Page Down> key to set the desired value.

☞ System Time

Sets the system time. The time format is hour, minute, and second. For example, 1 p.m. is 13:00:00. Use <Enter> to switch between the Hour, Minute, and Second fields and use the <Page Up> or <Page Down> key to set the desired value.

2-5 BIOS



- **Bootup NumLock State**
Enables or disables Numlock feature on the numeric keypad of the keyboard after the POST. (Default: On)
- **Security Option**
Specifies whether a password is required every time the system boots, or only when you enter BIOS Setup. After configuring this item, set the password(s) under the **Administrator Password/User Password** item.
 - ▶▶ Setup A password is only required for entering the BIOS Setup program.
 - ▶▶ System A password is required for booting the system and for entering the BIOS Setup program. (Default)
- **Full Screen LOGO Show**
Allows you to determine whether to display the GIGABYTE Logo at system startup. **Disabled** skips the GIGABYTE Logo when the system starts up. (Default: Enabled)
- **Boot Option Priorities**
Specifies the overall boot order from the available devices. Removable storage devices that support GPT format will be prefixed with "UEFI:" string on the boot device list. To boot from an operating system that supports GPT partitioning, select the device prefixed with "UEFI:" string.
Or if you want to install an operating system that supports GPT partitioning such as Windows 10 64-bit, select the optical drive that contains the Windows 10 64-bit installation disk and is prefixed with "UEFI:" string.
- **Hard Drive/CD/DVD ROM Drive/Floppy Drive/Network Device BBS Priorities**
Specifies the boot order for a specific device type, such as hard drives, optical drives, floppy disk drives, and devices that support Boot from LAN function, etc. Press <Enter> on this item to enter the submenu that presents the devices of the same type that are connected. This item is present only if at least one device for this type is installed.
- **Fast Boot**
Enables or disables Fast Boot to shorten the OS boot process. **Ultra Fast** provides the fastest bootup speed. (Default: Disabled)

☞ **SATA Support**

- ▶▶ Last Boot HDD Only Except for the previous boot drive, all SATA devices are disabled before the OS boot process completes. (Default)
- ▶▶ All Sata Devices All SATA devices are functional in the operating system and during the POST. This item is configurable only when **Fast Boot** is set to **Enabled** or **Ultra Fast**.

☞ **VGA Support**

Allows you to select which type of operating system to boot.

- ▶▶ Auto Enables legacy option ROM only.
- ▶▶ EFI Driver Enables EFI option ROM. (Default)

This item is configurable only when **Fast Boot** is set to **Enabled** or **Ultra Fast**.

☞ **USB Support**

- ▶▶ Disabled All USB devices are disabled before the OS boot process completes.
- ▶▶ Full Initial All USB devices are functional in the operating system and during the POST.
- ▶▶ Partial Initial Part of the USB devices are disabled before the OS boot process completes. (Default)

This item is configurable only when **Fast Boot** is set to **Enabled**. This function is disabled when **Fast Boot** is set to **Ultra Fast**.

☞ **PS2 Devices Support**

- ▶▶ Disabled All PS/2 devices are disabled before the OS boot process completes.
- ▶▶ Enabled All PS/2 devices are functional in the operating system and during the POST. (Default)

This item is configurable only when **Fast Boot** is set to **Enabled**. This function is disabled when **Fast Boot** is set to **Ultra Fast**.

☞ **NetWork Stack Driver Support**

- ▶▶ Disabled Disables booting from the network. (Default)
- ▶▶ Enabled Enables booting from the network.

This item is configurable only when **Fast Boot** is set to **Enabled** or **Ultra Fast**.

☞ **Next Boot After AC Power Loss**

- ▶▶ Normal Boot Enables normal bootup upon the return of the AC power. (Default)
- ▶▶ Fast Boot Keeps the Fast Boot settings upon the return of the AC power.

This item is configurable only when **Fast Boot** is set to **Enabled** or **Ultra Fast**.

☞ **Mouse Speed**

Allows you to set the mouse cursor movement speed. (Default: 1 X)

☞ **CSM Support**

Enables or disables UEFI CSM (Compatibility Support Module) to support a legacy PC boot process.

- ▶▶ Disabled Disables UEFI CSM and supports UEFI BIOS boot process only. (Default)
- ▶▶ Enabled Enables UEFI CSM.

☞ **LAN PXE Boot Option ROM**

Allows you to select whether to enable the legacy option ROM for the LAN controller. (Default: Disabled)

This item is configurable only when **CSM Support** is set to **Enabled**.

☞ **Storage Boot Option Control**

Allows you to select whether to enable the UEFI or legacy option ROM for the storage device controller.

- ▶▶ Do not launch Disables option ROM.
- ▶▶ Legacy Enables legacy option ROM only.
- ▶▶ UEFI Enables UEFI option ROM only. (Default)

This item is configurable only when **CSM Support** is set to **Enabled**.

☞ **Other PCI devices**

Allows you to select whether to enable the UEFI or Legacy option ROM for the PCI device controller other than the LAN, storage device, and graphics controllers.

- ▶▶ Do not launch Disables option ROM.
- ▶▶ Legacy Enables legacy option ROM only.
- ▶▶ UEFI Enables UEFI option ROM only. (Default)

This item is configurable only when **CSM Support** is set to **Enabled**.

☞ **Administrator Password**

Allows you to configure an administrator password. Press <Enter> on this item, type the password, and then press <Enter>. You will be requested to confirm the password. Type the password again and press <Enter>. You must enter the administrator password (or user password) at system startup and when entering BIOS Setup. Differing from the user password, the administrator password allows you to make changes to all BIOS settings.

☞ **User Password**

Allows you to configure a user password. Press <Enter> on this item, type the password, and then press <Enter>. You will be requested to confirm the password. Type the password again and press <Enter>. You must enter the administrator password (or user password) at system startup and when entering BIOS Setup. However, the user password only allows you to make changes to certain BIOS settings but not all.

To cancel the password, press <Enter> on the password item and when requested for the password, enter the correct one first. When prompted for a new password, press <Enter> without entering any password. Press <Enter> again when prompted to confirm.

NOTE: Before setting the User Password, be sure to set the Administrator Password first.

2-6 Peripherals



Initial Display Output

Specifies the first initiation of the monitor display from the installed PCI Express graphics card or the onboard graphics.

- ▶▶ IGFX Sets the onboard graphics as the first display.
- ▶▶ PCIe 1 Slot Sets the graphics card on the PCIEX16 slot as the first display. (Default)

OnBoard LAN Controller (LAN2)

Enables or disables the onboard LAN function. (Default: Enabled)

If you wish to install a 3rd party add-in network card instead of using the onboard LAN, set this item to **Disabled**.

Above 4G Decoding

Enables or disables 64-bit capable devices to be decoded in above 4 GB address space (only if your system supports 64-bit PCI decoding). Set to **Enabled** if more than one advanced graphics card are installed and their drivers are not able to be launched when entering the operating system (because of the limited 4 GB memory address space). (Default: Disabled)

RGB Fusion (LED strip)

Allows you to set the display color of the external LED strip.

Intel Platform Trust Technology (PTT)

Enables or disables Intel® PTT Technology. (Default: Disabled)

Software Guard Extensions (SGX)

Enables or disables the Intel® Software Guard Extensions technology. This feature allows legal software to operate in a safe environment and protects the software against attacks from malicious software. The Software Controlled option allows you to enable or disable this feature with an Intel-provided application. (Default: Software Controlled)

OffBoard SATA Controller Configuration

Displays information on your M.2 PCIe SSD if installed.

▶ **Trusted Computing**

Enables or disables Trusted Platform Module (TPM).

▶ **Super IO Configuration**

☞ **Serial Port 1/2/3/4**

Enables or disables the onboard serial port. (Default: Enabled)

▶ **Intel(R) Bios Guard Technology**

Enables or disables the Intel® BIOS Guard feature, which protects the BIOS from malicious attacks.

▶ **USB Configuration**

☞ **Legacy USB Support**

Allows USB keyboard/mouse to be used in MS-DOS. (Default: Enabled)

☞ **XHCI Hand-off**

Determines whether to enable XHCI Hand-off feature for an operating system without XHCI Hand-off support. (Default: Disabled)

☞ **USB Mass Storage Driver Support**

Enables or disables support for USB storage devices. (Default: Enabled)

☞ **Port 60/64 Emulation**

Enables or disables emulation of I/O ports 64h and 60h. This should be enabled for full legacy support for USB keyboards/mice in MS-DOS or in operating system that does not natively support USB devices. (Default: Disabled)

☞ **Mass Storage Devices**

Displays a list of connected USB mass storage devices. This item appears only when a USB storage device is installed.

▶ **Network Stack Configuration**

☞ **Network Stack**

Disables or enables booting from the network to install a GPT format OS, such as installing the OS from the Windows Deployment Services server. (Default: Disabled)

☞ **Ipv4 PXE Support**

Enables or disables IPv4 PXE Support. This item is configurable only when **Network Stack** is enabled.

☞ **Ipv4 HTTP Support**

Enables or disables HTTP boot support for IPv4. This item is configurable only when **Network Stack** is enabled.

☞ **Ipv6 PXE Support**

Enables or disables IPv6 PXE Support. This item is configurable only when **Network Stack** is enabled.

☞ **Ipv6 HTTP Support**

Enables or disables HTTP boot support for IPv6. This item is configurable only when **Network Stack** is enabled.

☞ **PXE boot wait time**

Allows you to configure how long to wait before you can press <Esc> to abort the PXE boot. This item is configurable only when **Network Stack** is enabled. (Default: 0)

☞ **Media detect count**

Allows you to set the number of times to check the presence of media. This item is configurable only when **Network Stack** is enabled. (Default: 1)

▶ **NVMe Configuration**

Displays information on your M.2 NVMe PCIe SSD if installed.

▶ **SATA And RST Configuration**

⊟ **SATA Controller(s)**

Enables or disables the integrated SATA controllers. (Default: Enabled)

⊟ **SATA Mode Selection**

Specifies the operating mode of the integrated SATA controllers.

▶▶ Intel RST With Intel Optane System Acceleration Enables Intel® Optane™ Technology support for the SATA controllers.

▶▶ AHCI Configures the SATA controllers to AHCI mode. Advanced Host Controller Interface (AHCI) is an interface specification that allows the storage driver to enable advanced Serial ATA features such as Native Command Queuing and hot plug. (Default)

⊟ **Aggressive LPM Support**

Enables or disables the power saving feature, ALPM (Aggressive Link Power Management), for the Chipset SATA controllers. (Default: Enabled)

⊟ **Port 0/1/2/3**

Enables or disables each SATA port. (Default: Enabled)

⊟ **Hot plug**

Enables or disable the hot plug capability for each SATA port. (Default: Disabled)

⊟ **Configured as eSATA**

Enables or disables support for external SATA devices.

▶ **Intel(R) Ethernet Connection**

This sub-menu provides information on LAN configuration and related configuration options.

2-7 Chipset



- ⌵ **VT-d (Note)**
Enables or disables Intel® Virtualization Technology for Directed I/O. (Default: Enabled)
- ⌵ **Internal Graphics**
Enables or disables the onboard graphics function. (Default: Auto)
- ⌵ **DVMT Pre-Allocated**
Allows you to set the onboard graphics memory size. Options are: 32M~1024M. (Default: 64M)
- ⌵ **DVMT Total Gfx Mem**
Allows you to allocate the DVMT memory size of the onboard graphics. Options are: 128M, 256M, MAX. (Default: 256M)
- ⌵ **Audio Controller**
Enables or disables the onboard audio function. (Default: Enabled)
If you wish to install a 3rd party add-in audio card instead of using the onboard audio, set this item to **Disabled**.
- ⌵ **PCH LAN Controller (LAN1)**
Enables or disables the onboard LAN function. (Default: Enabled)
If you wish to install a 3rd party add-in network card instead of using the onboard LAN, set this item to **Disabled**.
- ⌵ **Wake on LAN Enable**
Enables or disables the wake on LAN function. (Default: Enabled)
- ⌵ **High Precision Timer**
Enables or disables High Precision Event Timer (HPET) in the operating system. (Default: Enabled)
- ⌵ **IOAPIC 24-119 Entries**
Enables or disables this function. (Default: Enabled)

(Note) This item is present only when you install a CPU that supports this feature. For more information about Intel® CPUs' unique features, please visit Intel's website.

2-8 Power



- ☞ **Platform Power Management**
Enables or disables the Active State Power Management function (ASPM). (Default: Enabled)
- ☞ **PEG ASPM**
Allows you to configure the ASPM mode for the device connected to the CPU PEG bus. This item is configurable only when **Platform Power Management** is set to **Enabled**. (Default: Enabled)
- ☞ **PCH ASPM**
Allows you to configure the ASPM mode for the device connected to Chipset's PCI Express bus. This item is configurable only when **Platform Power Management** is set to **Enabled**. (Default: Enabled)
- ☞ **DMI ASPM**
Allows you to configure the ASPM mode for both CPU side and Chipset side of the DMI link. This item is configurable only when **Platform Power Management** is set to **Enabled**. (Default: Enabled)
- ☞ **AC BACK**
Determines the state of the system after the return of power from an AC power loss.
 - ▶▶ Memory The system returns to its last known awake state upon the return of the AC power.
 - ▶▶ Always On The system is turned on upon the return of the AC power.
 - ▶▶ Always Off The system stays off upon the return of the AC power. (Default)
- ☞ **Power On By Keyboard**
Allows the system to be turned on by a PS/2 keyboard wake-up event.
Note: To use this function, you need an ATX power supply providing at least 1A on the +5VSB lead.
 - ▶▶ Disabled Disables this function. (Default)
 - ▶▶ Any Key Press any key to turn on the system.
 - ▶▶ Keyboard 98 Press POWER button on the Windows 98 keyboard to turn on the system.
 - ▶▶ Password Set a password with 1~5 characters to turn on the system.

☞ **Power On Password**

Set the password when **Power On By Keyboard** is set to **Password**.

Press <Enter> on this item and set a password with up to 5 characters and then press <Enter> to accept. To turn on the system, enter the password and press <Enter>.

Note: To cancel the password, press <Enter> on this item. When prompted for the password, press <Enter> again without entering the password to clear the password settings.

☞ **Power On By Mouse**

Allows the system to be turned on by a PS/2 mouse wake-up event.

Note: To use this function, you need an ATX power supply providing at least 1A on the +5VSB lead.

- ▶▶ Disabled Disables this function. (Default)
- ▶▶ Move Move the mouse to turn on the system.
- ▶▶ Double Click Double click on left button on the mouse to turn on the system.

☞ **ErP**

Determines whether to let the system consume least power in S5 (shutdown) state. (Default: Disabled)

Note: When this item is set to **Enabled**, the following functions will become unavailable: Resume by Alarm, power on by mouse, and power on by keyboard.

☞ **Soft-Off by PWR-BTTN**

Configures the way to turn off the computer in MS-DOS mode using the power button.

- ▶▶ Instant-Off Press the power button and then the system will be turned off instantly. (Default)
- ▶▶ Delay 4 Sec. Press and hold the power button for 4 seconds to turn off the system. If the power button is pressed for less than 4 seconds, the system will enter suspend mode.

☞ **Resume by Alarm**

Determines whether to power on the system at a desired time. (Default: Disabled)

If enabled, set the date and time as following:

- ▶▶ Wake up day: Turn on the system at a specific time on each day or on a specific day in a month.
- ▶▶ Wake up hour/minute/second: Set the time at which the system will be powered on automatically.

Note: When using this function, avoid inadequate shutdown from the operating system or removal of the AC power, or the settings may not be effective.

☞ **Power Loading**

Enables or disables dummy load. When the power supply is at low load, a self-protection will activate causing it to shutdown or fail. If this occurs, please set to **Enabled**. **Auto** lets the BIOS automatically configure this setting. (Default: Auto)

☞ **CEC 2019 Ready**

Allows you to select whether to allow the system to adjust power consumption when it is in shutdown, idle, or standby state in order to comply with the CEC (California Energy Commission) 2019 Standards. (Default: Disabled)

☞ **RC6(Render Standby)**

Allows you to determine whether to let the onboard graphics enter standby mode to decrease power consumption. (Default: Enabled)

2-9 Save & Exit



☞ Save & Exit Setup

Press <Enter> on this item and select **Yes**. This saves the changes to the CMOS and exits the BIOS Setup program. Select **No** or press <Esc> to return to the BIOS Setup Main Menu.

☞ Exit Without Saving

Press <Enter> on this item and select **Yes**. This exits the BIOS Setup without saving the changes made in BIOS Setup to the CMOS. Select **No** or press <Esc> to return to the BIOS Setup Main Menu.

☞ Load Optimized Defaults

Press <Enter> on this item and select **Yes** to load the optimal BIOS default settings. The BIOS default settings help the system to operate in optimum state. Always load the Optimized defaults after updating the BIOS or after clearing the CMOS values.

☞ Boot Override

Allows you to select a device to boot immediately. Press <Enter> on the device you select and select **Yes** to confirm. Your system will restart automatically and boot from that device.

☞ Save Profiles

This function allows you to save the current BIOS settings to a profile. You can create up to 8 profiles and save as Setup Profile 1~ Setup Profile 8. Press <Enter> to complete. Or you can select **Select File in HDD/FDD/USB** to save the profile to your storage device.

☞ Load Profiles

If your system becomes unstable and you have loaded the BIOS default settings, you can use this function to load the BIOS settings from a profile created before, without the hassles of reconfiguring the BIOS settings. First select the profile you wish to load and then press <Enter> to complete. You can select **Select File in HDD/FDD/USB** to input the profile previously created from your storage device or load the profile automatically created by the BIOS, such as reverting the BIOS settings to the last settings that worked properly (last known good record).

Chapter 3 Appendix

3-1 Installing an Intel® Optane™ Memory

System Requirements

1. Intel® Optane™ memory
2. The Optane™ memory must have at least 16 GB capacity, and it must have equal or smaller capacity than the hard drive/SSD to be accelerated.
3. The hard drive/SSD to be accelerated must be a SATA hard drive or M.2 SATA SSD and must have Windows 10 64-bit (or later version) installed on it. (Must be formatted for GPT partition.)
4. The motherboard driver disk

Installation Guidelines

A-1: Installation in AHCI mode

If the SATA controller has been configured in AHCI mode, please follow the steps below:

1. After entering the operating system, insert the motherboard driver disk into your optical drive. On the Xpress Install screen, select **Intel(R) Optane(TM) Memory System Acceleration** ^(Note) to install. Follow the on-screen instructions to continue. The system will auto-restart.
2. After re-entering the operating system, the dialog box as shown above will appear. Click **Yes** to continue the installation and then restart the system.
3. Launch the Intel(R) Optane Memory application from the Start menu. A message which says Intel® Optane™ Memory is disabled will appear on the main screen. Click **Enable** to activate the Intel® Optane™ Memory and restart the system again.
4. Launch the Intel(R) Optane Memory application from the Start menu and make sure the Intel® Optane™ Memory has been enabled. (The SATA controller mode is changed to Intel RST With Intel Optane System Acceleration from AHCI mode. DO NOT change your SATA controller mode back to AHCI. Doing so will prevent Intel® Optane™ memory from functioning properly.)

A-2: Installation in Intel RST With Intel Optane System Acceleration mode

If the SATA controller has been configured in Intel RST With Intel Optane System Acceleration mode, please follow the steps below:

1. After system restarts, go to the BIOS Setup, make sure **CSM Support** under the **BIOS** menu is disabled.
2. Go to **Peripherals\SATA And RST Configuration** and make sure **Use RST Legacy OROM** is disabled. If you want to enable the Optane™ memory installed in the M.2 connector, set **PCIe Storage Device on Port 21** to **RST Controlled**.
3. Enter the operating system, launch the Intel® Rapid Storage Technology utility from the Start menu, and then enable Intel® Optane™ Memory on the **Intel® Optane™ Memory** screen.
4. Follow the on-screen instruction to continue the installation and then restart the system when completed.



- An Optane™ memory cannot be used to accelerate an M.2 PCIe SSD.
- Do not abruptly remove the Optane™ memory. Doing so will cause the operating system to stop functioning correctly.
- If you want to change/remove the Optane™ memory, you must disable it using the Intel® Rapid Storage Technology or Intel(R) Optane™ Memory application first.
- After enabling the Optane™ memory, the related BIOS settings will remain even after a BIOS update.

(Note) If the system already has Intel® Rapid Storage Technology utility installed, you have to remove it first before installing the Intel(R) Optane(TM) Memory System Acceleration application.

3-2 Drivers Installation



- Before installing the drivers, first install the operating system.
- After installing the operating system, insert the motherboard driver disk into your optical drive. Click on the message "Tap to choose what happens with this disc" on the top-right corner of the screen and select "Run Run.exe." (Or go to My Computer, double-click the optical drive and execute the Run.exe program.)

"Xpress Install" will automatically scan your system and then list all of the drivers that are recommended to install. You can click the **Xpress Install** button and "Xpress Install" will install all of the selected drivers. Or click the arrow **Install** icon to individually install the drivers you need.

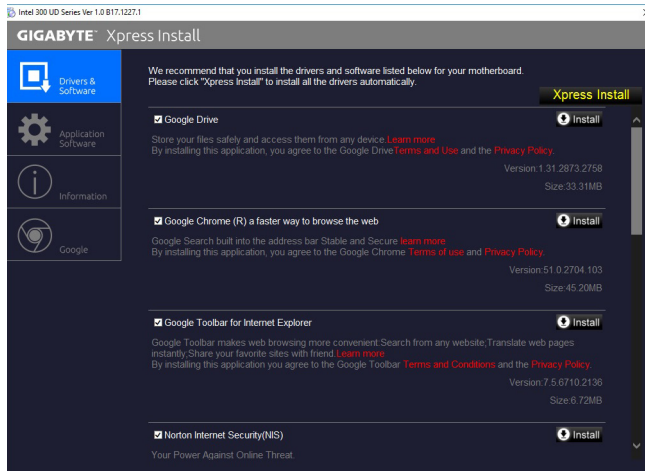

Please visit GIGABYTE's website for more software information.



Please visit GIGABYTE's website for more troubleshooting information.

Regulatory Statements

Regulatory Notices

This document must not be copied without our written permission, and the contents there of must not be imparted to a third party nor be used for any unauthorized purpose.

Contravention will be prosecuted. We believe that the information contained herein was accurate in all respects at the time of printing. GIGABYTE cannot, however, assume any responsibility for errors or omissions in this text. Also note that the information in this document is subject to change without notice and should not be construed as a commitment by GIGABYTE.

Our Commitment to Preserving the Environment

In addition to high-efficiency performance, all GIGABYTE motherboards fulfill European Union regulations for RoHS (Restriction of Certain Hazardous Substances in Electrical and Electronic Equipment) and WEEE (Waste Electrical and Electronic Equipment) environmental directives, as well as most major worldwide safety requirements. To prevent releases of harmful substances into the environment and to maximize the use of our natural resources, GIGABYTE provides the following information on how you can responsibly recycle or reuse most of the materials in your "end of life" product.

Restriction of Hazardous Substances (RoHS) Directive Statement

GIGABYTE products have not intended to add and safe from hazardous substances (Cd, Pb, Hg, Cr+6, PBDE and PBB). The parts and components have been carefully selected to meet RoHS requirement. Moreover, we at GIGABYTE are continuing our efforts to develop products that do not use internationally banned toxic chemicals.

Waste Electrical & Electronic Equipment (WEEE) Directive Statement

GIGABYTE will fulfill the national laws as interpreted from the 2002/96/EC WEEE (Waste Electrical and Electronic Equipment) directive. The WEEE Directive specifies the treatment, collection, recycling and disposal of electric and electronic devices and their components. Under the Directive, used equipment must be marked, collected separately, and disposed of properly.

WEEE Symbol Statement



The symbol shown below is on the product or on its packaging, which indicates that this product must not be disposed of with other waste. Instead, the device should be taken to the waste collection centers for activation of the treatment, collection, recycling and disposal procedure. The separate collection and recycling of your waste equipment at the time of disposal will help to conserve natural resources and ensure that it is recycled in a manner that protects human health and the environment.

For more information about where you can drop off your waste equipment for recycling, please contact your local government office, your household waste disposal service or where you purchased the product for details of environmentally safe recycling.

- ♦ When your electrical or electronic equipment is no longer useful to you, "take it back" to your local or regional waste collection administration for recycling.
- ♦ If you need further assistance in recycling, reusing in your "end of life" product, you may contact us at the Customer Care number listed in your product's user's manual and we will be glad to help you with your effort.

Finally, we suggest that you practice other environmentally friendly actions by understanding and using the energy-saving features of this product (where applicable), recycling the inner and outer packaging (including shipping containers) this product was delivered in, and by disposing of or recycling used batteries properly. With your help, we can reduce the amount of natural resources needed to produce electrical and electronic equipment, minimize the use of landfills for the disposal of "end of life" products, and generally improve our quality of life by ensuring that potentially hazardous substances are not released into the environment and are disposed of properly.

FCC Notice (U.S.A. Only)

Operation is subject to the following two conditions: (1) this device may not cause harmful interference, and (2) this device must accept any interference received, including interference that may cause undesired operation. **WARNING:** This equipment has been tested and found to comply with the limits for a Class B digital device, pursuant to Part 15 of the FCC Rules. These limits are designed to provide reasonable protection against harmful interference in a residential installation.

This equipment generates and radiates radio frequency energy and, if not installed and used in accordance with the instructions, may cause harmful interference to radio communications.

However, there is no guarantee that interference will not occur in a particular installation. If this equipment does cause harmful interference to radio or television reception, which can be determined by turning the equipment off and on, the user is encouraged to try to correct the interference by one or more of the following measures:

- Reorient or relocate the receiving antenna.
- Increase the separation between the equipment and receiver.
- Connect the equipment into an outlet on a circuit different from that to which the receiver is connected.
- Consult a dealer or experienced TV/radio technician for help.

The user may find the following booklet prepared by the Federal Communications Commission helpful: The Interference Handbook.

This booklet is available from the U.S. Government Printing Office, Washington, D.C.20402. Stock No.004-000-00345-4

Notice for 5GHz

Operations in the 5.15-5.25GHz band are restricted to indoor usage only. (For 5GHz only)

RF exposure statement

The product comply with the FCC portable RF exposure limit set forth for an uncontrolled environment and are safe for intended operation as described in this manual. The further RF exposure reduction can be achieved if the product can be kept as far as possible from the user body or set the device to lower output power if such function is available.

CAUTION:

The manufacturer is not responsible for any interference caused by unauthorized modifications and/or use of unauthorized antennas. Such changes and/or modifications not expressly approved by the party responsible for compliance of this device could void the user's authority to operate the equipment.

Canada-Industry Canada (IC):

This device complies with Canadian RSS-210.

This device complies with Industry Canada license-exempt RSS standard(s). Operation is subject to the following two conditions:

- (1) this device may not cause interference, and
- (2) this device must accept any interference, including interference that may cause undesired operation of the device.

Ce dispositif est conforme à la norme CNR-210 d'Industrie Canada applicable aux appareils radio exempts de licence. Son fonctionnement est sujet aux deux conditions suivantes:

- (1) le dispositif ne doit pas produire de brouillage préjudiciable, et
- (2) ce dispositif doit accepter tout brouillage reçu, y compris un brouillage susceptible de provoquer un fonctionnement indésirable.

Notice for 5GHz:

Caution :

- (i) the device for operation in the band 5150-5250 MHz is only for indoor use to reduce the potential for harmful interference to co-channel mobile satellite systems;
- (ii) the maximum antenna gain permitted for devices in the bands 5250-5350 MHz and 5470-5725 MHz shall comply with the e.i.r.p. limit; and
- (iii) the maximum antenna gain permitted for devices in the band 5725-5825 MHz shall comply with the e.i.r.p. limits specified for point-to-point and non point-to-point operation as appropriate.
- (iv) Users should also be advised that high-power radars are allocated as primary users (i.e. priority users) of the bands 5250-5350 MHz and 5650-5850 MHz and that these radars could cause interference and/or damage to LE-LAN devices.

Avertissement:

Le guide d'utilisation des dispositifs pour réseaux locaux doit inclure des instructions précises sur les restrictions susmentionnées, notamment :

- (i) les dispositifs fonctionnant dans la bande 5 150-5 250 MHz sont réservés uniquement pour une utilisation à l'intérieur afin de réduire les risques de brouillage préjudiciable aux systèmes de satellites mobiles utilisant les mêmes canaux;
- (ii) le gain maximal d'antenne permis pour les dispositifs utilisant les bandes 5 250-5 350 MHz et 5 470-5 725 MHz doit se conformer à la limite de p.i.r.e.;
- (iii) le gain maximal d'antenne permis (pour les dispositifs utilisant la bande 5 725-5 825 MHz) doit se conformer à la limite de p.i.r.e. spécifiée pour l'exploitation point à point et non point à point, selon le cas.
- (iv) De plus, les utilisateurs devraient aussi être avisés que les utilisateurs de radars de haute puissance sont désignés utilisateurs principaux (c.-à-d., qu'ils ont la priorité) pour les bandes 5 250-5 350 MHz et 5 650-5 850 MHz et que ces radars pourraient causer du brouillage et/ou des dommages aux dispositifs LAN-EL.

Radiation Exposure Statement:

The product comply with the Canada portable RF exposure limit set forth for an uncontrolled environment and are safe for intended operation as described in this manual. The further RF exposure reduction can be achieved if the product can be kept as far as possible from the user body or set the device to lower output power if such function is available.

European Community Radio Equipment Directive (RED) Compliance Statement:

This equipment complies with all the requirements and other relevant provisions of Radio Equipment Directive 2014/53/EU.

This equipment is suitable for home and office use in all the European Community Member States and EFTA Member States.

The low band 5.15 -5.35 GHz is for indoor use only.

Restrictions d'utilisation en France:

Pour la France métropolitaine

2.400 - 2.4835 GHz (Canaux 1 à 13) autorisé en usage intérieur

2.400 - 2.454 GHz (canaux 1 à 7) autorisé en usage extérieur

Pour la Guyane et la Réunion

2.400 - 2.4835 GHz (Canaux 1 à 13) autorisé en usage intérieur

2.420 - 2.4835 GHz (canaux 5 à 13) autorisé en usage extérieur

Notice for Italy:

The use of these equipments is regulated by:

1. D.L.gs 1.8.2003, n. 259, article 104 (activity subject to general authorization) for outdoor use and article 105 (free use) for indoor use, in both cases for private use.
2. D.M. 28.5.03, for supply to public of RLAN access to networks and telecom services. L'uso degli apparati è regolamentato da:
 1. D.L.gs 1.8.2003, n. 259, articoli 104 (attività soggette ad autorizzazione generale) se utilizzati al di fuori del proprio fondo e 105 (libero uso) se utilizzati entro il proprio fondo, in entrambi i casi per uso private.
 2. D.M. 28.5.03, per la fornitura al pubblico dell'accesso R-LAN alle reti e ai servizi di telecomunicazioni.

Taiwan NCC Wireless Statements / 無線設備警告聲明:

低功率電波輻射性電機管理辦法

第十二條: 經型式認證合格之低功率射頻電機, 非經許可, 公司、商號或使用者均不得擅自變更頻率、加大功率或變更原設計之特性及功能。

第十四條: 低功率射頻電機之使用不得影響飛航安全及干擾合法通信; 經發現有干擾現象時, 應立即停用, 並改善至無干擾時方得繼續使用。前項合法通信, 指依電信法規定作業之無線電通信。低功率射頻電機須忍受合法通信或工業、科學及醫療用電波輻射性電機設備之干擾。

在5.25-5.35GHz頻帶內操作之無線資訊傳輸設備, 限於室內使用。

Korea KCC NCC Wireless Statement:

5,25 GHz - 5,35 GHz 대역을 사용하는 무선 장치는 실내에서만 사용하도록 제한됩니다.

Japan Wireless Statement:

5.15GHz帯 ~ 5.35GHz帯: 屋内のみの使用。



Contact Us

GIGA-BYTE TECHNOLOGY CO., LTD.

Address: No.6, Baoqiang Rd., Xindian Dist., New Taipei City 231, Taiwan

TEL: +886-2-8912-4000, FAX: +886-2-8912-4005

Tech. and Non-Tech. Support (Sales/Marketing) : <http://esupport.gigabyte.com>

WEB address (English): <http://www.gigabyte.com>

WEB address (Chinese): <http://www.gigabyte.tw>

- **GIGABYTE eSupport**

To submit a technical or non-technical (Sales/Marketing) question, please link to:
<http://esupport.gigabyte.com>

