

How To Install a Server into a Tank

G152

Installing Server



CAUTION!

- Make sure the crane can handle at least 60 KG before installing the server into a tank.
- Only licensed professionals are authorized to access the restricted access location.
- The power supply fan is disabled by default, so the server must be immersed in the fluid before powering on.
- Consult with immersion cooling tank vendor to ensure compatibility and read their tank manual thoroughly.
- Do not install a GPU into the system without consulting GIGABYTE first, doing so may cause compatibility issues.



DANGER!

- Strongly recommended to use gloves when handling the coolant.
- Before handling coolant, handlers must read the material safety data sheet (MSDS) for their safety.
- The thermal pad contains Indium foil, so it is strongly recommended to use gloves when replacing the thermal pad.

Installation

- 1 Attach the two carabiners to server handles.
- 2 Put the server into the tank vertically.

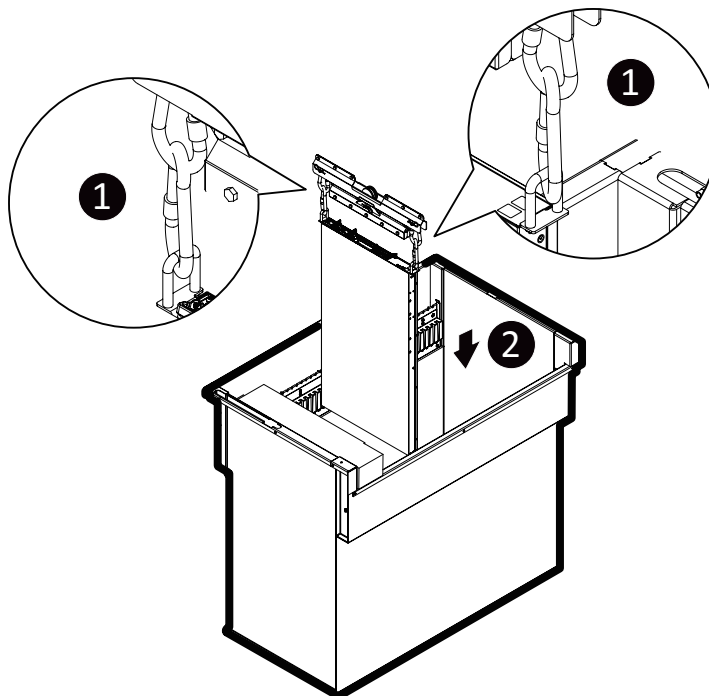

Installing Optional Handles

NOTE! The optional handles are only for Asperitas tank.

- 1 Attach the handles to server.
- 2 Secure the handles with screws.
- 3 Install server into the tank.

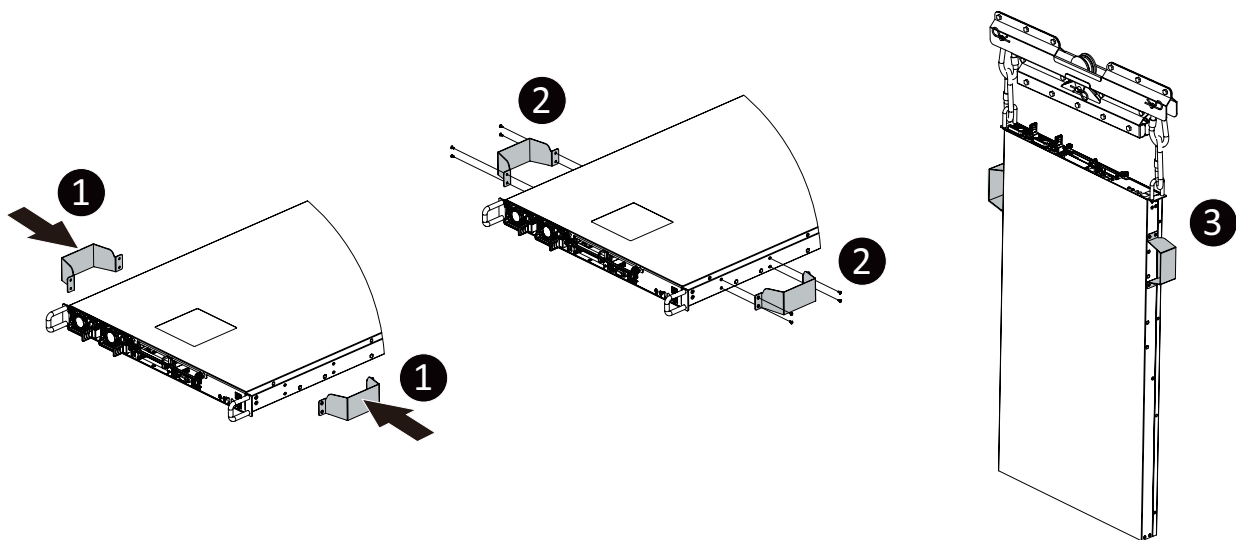

How To Install a Thermal Pad to CPU

Installing Thermal Pad



DANGER!

- Strongly recommended to use gloves and mask when handling the thermal pad.
- The thermal pad contains Indium foil, so it is strongly recommended to use gloves when replacing the thermal pad.

Installation

- 1 Place the thermal pad on the top of CPU.

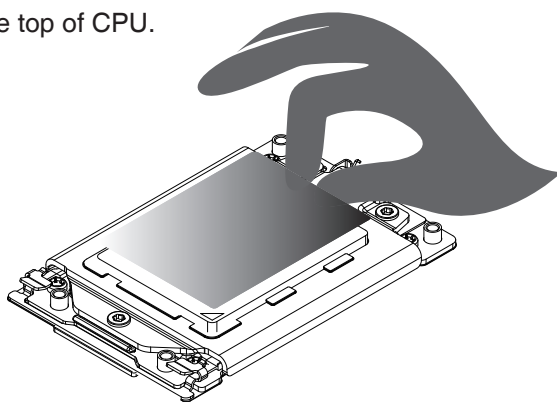

- 2 Install the CPU heatsink.

When installing the heatsink to CPU, use a Torx T20 screwdriver to tighten 4 captive nuts in sequence as 1-4.
The screw tightening torque: 10 ± 0.5 kgf-cm.

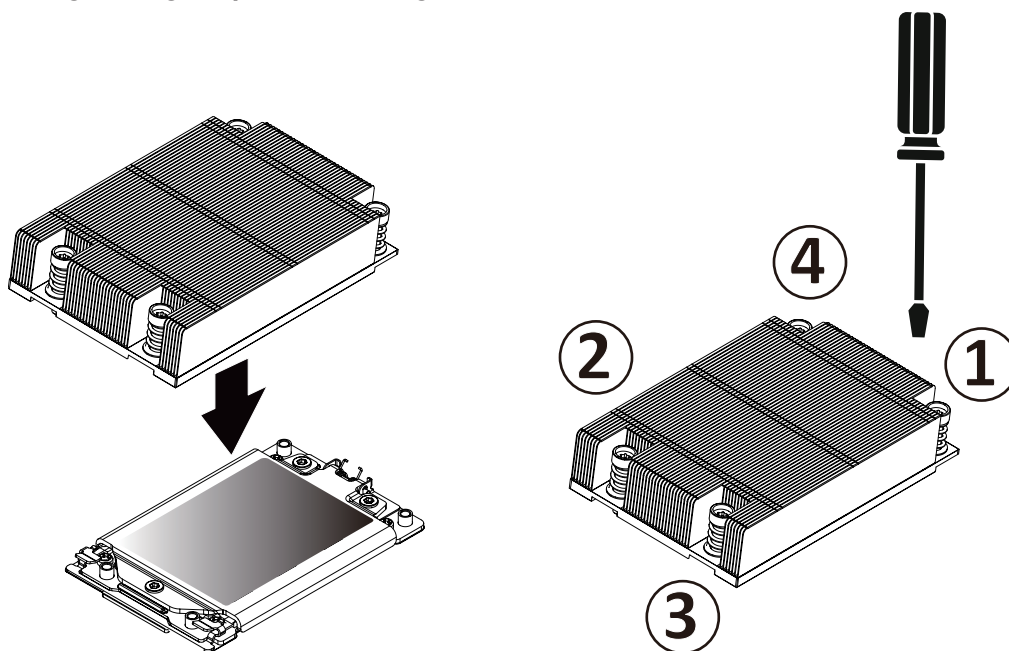

Learn more about GIGABYTE server, visit www.gigabyte.com/Enterprise

* All specifications are subject to change without notice. Please visit our website for the latest information.

* All other brands, logos and names are property of their respective owners.

© 2023 Giga Computing Technology Co., Ltd. All rights reserved.

Engineered by

