

GIGABYTE™



BRIX

Ultra Compact PC Kit

GB-BTIP-N150/GB-BTIP-N250

Quick Start Guide

Rev. 1.0

BRIX Ultra Compact PC Kit

BRIX GB-BT Ultrakompaktes PC Kit / Kit PC ultra compact BRIX GB-BT /
Kit de PC ultra compacto BRIX GB-BT / Kit PC BRIX GB-BT Ultra Compact /
Kit per PC BRIX GB-BT Ultra Compacto /
Ультеракомпактний ПК BRIX GB-BT, базовий комплект /
Zestaw BRIX GB-BT Ultra Compact PC / BRIX GB-BT Ultra Kompakt PC Kiti /
BRIX GB-BT 系列超微型電腦 /
BRIX GB-BT 系列超微型台式计算机 /
BRIX GB-BT 超小型PCキット /
BRIX GB-BT Ultra Compact PC 키트

Quick Start Guide

Kurzanleitung / Guide de démarrage rapide / Guía de inicio rápido /
Guia de início rápido / Guida di avvio rapido / Краткое руководство /
Skrócona instrukcja obsługi / Hızlı Başlangıç Kılavuzu /
快速入門使用者手冊 / 快速入門指南 / クイックスタートガイド / 빠른 시작 가이드

Copyright

© 2025 GIGAIPC CO., LTD. All rights reserved.

The marks mentioned herein are trademarks or registered trademarks of GIGAIPC CO., LTD. or its affiliates. All other product names mentioned herein are trademarks or registered trademarks or their respective owners.

Disclaimer

Information in this manual is protected by copyright laws and is the property of GIGAIPC. Changes to the specifications and features in this manual may be made by GIGAIPC without prior notice. No part of this manual may be reproduced, copied, translated, transmitted, or published in any form or by any means without GIGAIPC's prior written permission.

Support

Please visit <https://www.gigabyte.com/support-downloads/customer-service> to find your BRIX warranty information from the drop down list, or by clicking on the map. You will then be directed to the corresponding page for your region.

- For a list of tested memory, M.2 SSD, wireless adapters and OS supported, go to: <https://www.gigabyte.com>
- To download the latest drivers and BIOS updates, go to <https://www.gigabyte.com>:
- For product support, go to <https://www.gigabyte.com>:

Support

Please visit Bitte besuchen Sie <https://www.gigabyte.com/support-downloads/customer-service>, um Ihre BRIX Garantieinformationen aus der Dropdown-Liste oder durch Klicken auf die Karte zu finden. Sie werden dann auf die entsprechende Seite für Ihre Region weitergeleitet.

- Eine Liste der getesteten Arbeitsspeicher, M.2 SSD, WLAN Adapter und unterstützten Betriebssysteme finden Sie unter: <https://www.gigabyte.com>
- Die neuesten Treiber und BIOS-Updates finden Sie unter: <https://www.gigabyte.com>:
- Produktunterstützung erhalten Sie unter: <https://www.gigabyte.com>:

Soutien

Veillez visite <https://www.gigabyte.com/support-downloads/customer-service> pour trouver vos informations de garantie BRIX dans la liste déroulante ou en cliquant sur la carte. Vous serez alors dirigé vers la page correspondante pour votre région.

- Pour obtenir la liste des mémoires testées, des SSD M.2, des adaptateurs sans fil et des systèmes d'exploitation pris en charge, consultez le site <https://www.gigabyte.com>
- Pour télécharger les derniers pilotes et les dernières mises à jour du BIOS, rendez-vous à l'adresse suivante <https://www.gigabyte.com>:
- Pour le support produit, consultez le site : <https://www.gigabyte.com>:

Soporte

Veillez consulter le site <https://www.gigabyte.com/support-downloads/customer-service> pour trouver les informations relatives à votre garantie BRIX dans la liste déroulante ou en cliquant sur la carte. Vous serez alors dirigé vers la page correspondant à votre région.

- Para obtener una lista de la memoria probada, SSD M.2, adaptadores inalámbricos y SO compatibles, vaya a: <https://www.gigabyte.com>
- Para descargar los drivers y las actualizaciones de BIOS más recientes, vaya a: <https://www.gigabyte.com>:
- Para soporte del producto, vaya a: <https://www.gigabyte.com>:

Suporte

Visite <https://www.gigabyte.com/support-downloads/customer-service> para encontrar as suas informações de garantia BRIX a partir da lista suspensa, ou ao clicar no mapa. Será depois direcionado para a página correspondente para a sua região.

- Para uma lista de memória testada, M.2 SSD, adaptadores sem fios e SO suportado, ir para: <https://www.gigabyte.com>
- Para transferir as drivers mais recentes e atualizações BIOS, ir para: <https://www.gigabyte.com>:
- Para suporte de produto, ir para: <https://www.gigabyte.com>

Supporto

Visitate <https://www.gigabyte.com/support-downloads/customer-service> per informazioni sul vostro BRIX dal menù a scorrimento, o cliccando sulla mappa. Verrete portati sulla pagina corrispondente alla vostra regione.

- Per una lista di memorie verificate, SSD M.2, adattatori senza cavo e sistemi operativi supportati, andate su <https://www.gigabyte.com>
- Per scaricare i driver e i BIOS aggiornati, andate su <https://www.gigabyte.com>:
- Per supporto sul prodotto, andate su <https://www.gigabyte.com>

Поддержка

Для получения гарантийной информации об продуктах BRIX посетите сайт <https://www.gigabyte.com/support-downloads/customer-service> и выберите вашу страну (регион) из выпадающего списка либо на имеющейся карте. Вы будете перенаправлены на страницу вашего региона.

- Перечень протестированных модулей памяти, накопителей M.2 SSD, беспроводных адаптеров и поддерживаемых ОС приведен на сайте: <https://www.gigabyte.com>
- Последние версии драйверов и обновлений BIOS можно загрузить на сайте: <https://www.gigabyte.com>:
- Для получения технической поддержки посетите сайт: <https://www.gigabyte.com>

Wsparcie

Odwiedź stronę <https://www.gigabyte.com/support-downloads/customer-service>, aby poznać informacje o gwarancji BRIX, wybierając je z listy rozwijanej lub klikając mapę. Następnie dojdzie do przekierowania na stronę odpowiednią dla Twojego regionu.

- Lista przetestowanych pamięci, dysków M.2 SSD, adapterów bezprzewodowych i obsługiwanych systemów operacyjnych znajduje się na stronie: <https://www.gigabyte.com>
- Aby pobrać najnowsze sterowniki i aktualizacje systemu BIOS, przejdź do: <https://www.gigabyte.com>:
- Aby uzyskać pomoc techniczną dla produktów należy wejść na stronę: <https://www.gigabyte.com>

Destek

Lütfen <https://www.gigabyte.com/support-downloads/customer-service> sayfasını ziyaret edin ve açılan listeden veya harita üzerine tıklayarak BRIX garantiniz hakkında daha fazla bilgi edinin. Daha sonra bölgenize uygun sayfaya yönlendirileceksiniz.

- Test edilmiş hafıza listesi, M.2 SSD, kablosuz adaptörler ve desteklenen OS sürümleri hakkında bilgi almak için: <https://www.gigabyte.com> sayfasına gidin
- En son sürücüleri ve BIOS güncellemelerini indirmek için: <https://www.gigabyte.com> sayfasına gidin
- Ürün desteği için: <https://www.gigabyte.com>

支援

請造訪 <https://www.gigabyte.com/support-downloads/customer-service>，從下拉式選單中尋找您的保固資訊，或按一下網站地圖，接著網站會引導您至所在區域之對應頁面。

- 如需以測試記憶體、M.2 SSD、無線介面卡和和支援的作業系統清單，請前往 <https://www.gigabyte.com>
- 若要下載最新驅動程式和BIOS更新，請前往 <https://www.gigabyte.com>：
- 如需產品支援資訊，請前往：<https://www.gigabyte.com>

支持

请访问 <https://www.gigabyte.com/support-downloads/customer-service>，在下拉列表中查找您的保修信息，或者点击地图。网页会跳转到您所在地区对应的页面。

- 要获取测试的内存、M.2 SSD、无线适配器和支持的OS列表，请访问：<https://www.gigabyte.com>
- 要下载最新的驱动器和BIOS更新，请访问：<https://www.gigabyte.com>：
- 要获取产品支持，请访问：<https://www.gigabyte.com>

サポート

<https://www.gigabyte.com/support-downloads/customer-service> を開いてドロップダウンリストから BRIX保証情報を見つけるか、地図上をクリックしてください。地域の対応するページに誘導されます。

- 試験済みのメモリ、M.2 SSD、ワイヤレスアダプタ、対応OSの一覧はこちら：<https://www.gigabyte.com>
- 最新のドライバとBIOSのアップデートはこちら <https://www.gigabyte.com>：
- 製品サポートはこちら：<https://www.gigabyte.com>

지원

<https://www.gigabyte.com/support-downloads/customer-service> 의 드롭다운 목록에서 또는 맵을 클릭하여 BRIX 보증 정보를 받으십시오. 그러면 사용자 지역의 해당 페이지로 이동합니다.

- 테스트된 메모리, M.2 SSD, 무선 어댑터 및 OS 지원 목록은 다음 사이트를 참조하십시오 <https://www.gigabyte.com>
- 최신 드라이버와 BIOS 업데이트를 다운로드하려면 다음 사이트로 이동하십시오 <https://www.gigabyte.com>:
- 제품 지원은 다음 사이트로 이동하십시오 <https://www.gigabyte.com>

Safety and Regulatory Information

- This product must be grounded with the plug on the adapter's power cord connected to a power socket with a grounding connection. Risk of explosion if the battery is replaced with an incorrect type. Batteries should be recycled where possible. Disposal of used Batteries, must be in accordance with local environmental regulations.
- Before you open chassis to exchange an internal component, you need to power off the device and let the device cool down at least 10 minutes.
- Failure to use the included Model GB-BT Power Adapter may violate regulatory compliance and may expose the user to safety hazards.

Sicherheit und gesetzliche Bestimmungen

- Es besteht das Risiko einer Explosion, wenn der Akku durch einen nicht geeigneten Typ ersetzt wird. Akkus sollten nach Möglichkeit recycelt werden. Die Entsorgung gebrauchter Akkus muss in Übereinstimmung mit den örtlichen Umweltvorschriften erfolgen.
- Vor dem öffnen des Gehäuses zum Auszutauschen einer internen Komponente müssen Sie das Gerät ausschalten und mindestens 10 Minuten abkühlen lassen.
- Falls das mitgelieferte Netzteil Modell GB-BT nicht verwendet wird, kann dies gegen die gesetzlichen Vorschriften verstoßen und den Benutzer Sicherheitsrisiken aussetzen.

Informations sur la sécurité et la réglementation

- Risque d'explosion si la batterie est remplacée par un type incorrect. Dans la mesure du possible, les batteries doivent être recyclées. L'élimination des batteries usagées doit être conforme à la réglementation environnementale locale.
- Avant d'ouvrir le châssis pour remplacer un composant interne, vous devez mettre l'appareil hors tension et le laisser refroidir au moins 10 minutes.
- Le fait de ne pas utiliser l'adaptateur d'alimentation modèle GB-BT inclus peut constituer une violation de la conformité réglementaire et peut exposer l'utilisateur à des risques de sécurité.

Información sobre normativa y de seguridad

- Existe riesgo de explosión si se sustituye la batería por una del tipo incorrecto. Las baterías deben reciclarse siempre que sea posible. La eliminación de las baterías usadas debe realizarse de acuerdo con las normas ambientales locales.
- Antes de abrir el chasis para cambiar un componente interno, debe apagar el dispositivo y dejar que se enfríe durante al menos 10 minutos.
- La no utilización del adaptador de corriente modelo GB-BT incluido puede violar el cumplimiento de la normativa y puede exponer al usuario a riesgos de seguridad..

Informações de segurança e regulamentares

- Risco de explosão se a pilha é substituída por um tipo incorreto. As pilhas devem ser recicladas quando possível. A eliminação de pilhas usadas deve ser efetuada conforme os regulamentos ambientais locais.
- Antes de abrir o chassis para alterar um componente interno, tem de desligar o dispositivo e deixar o dispositivo arrefecer, pelo menos, 10 minutos.
- Não utilizar o adaptador de alimentação modelo GB-BT pode violar a conformidade regulamentar e pode expor o utilizador a perigos de segurança.

Informazioni di sicurezza e sui regolamenti

- Sostituire la batteria con una di tipo non corretto può comportare rischio di esplosione. Se possibile, le batterie vanno riciclate. Lo smaltimento delle batterie usate effettuato secondo le regole ambientali in vigore nella regione in cui ci si trova.
- Prima di aprire il telaio per cambiare un componente interno, spegnere il dispositivo e lasciarlo raffreddare per almeno 10 minuti.
- Se non si usa l'adattatore per l'alimentazione modello GB-BT compreso nella confezione si rischia di violare il regolamento, e di esporre l'utente a un pericolo per la sua sicurezza..

Соответствие требованиям безопасности

- Замена батареи на батарею ненадлежащего типа может привести к взрыву. Использованные батареи следует сдавать на переработку при наличии и соответствующих возможностей. Утилизация использованных батарей должна осуществляться в соответствии с местными экологическими нормами.
- Перед открытием корпуса для замены внутренних компонентов следует выключить устройство и дать ему охладиться в течение 10 минут.
- Неиспользование прилагаемого адаптера питания модели GB-BT является нарушением нормативных требований и может привести к возникновению опасных для пользователя ситуаций.

Informacje dotyczące bezpieczeństwa i przepisów

- Jeśli bateria zostanie wymieniona na baterię niewłaściwego typu istnieje ryzyko wybuchu. W miarę możliwości baterie należy poddawać recyklingowi. Utylizacja zużytych baterii musi być zgodna z lokalnymi przepisami dotyczącymi ochrony środowiska.
- Przed otwarciem obudowy w celu wymiany komponentu wewnętrznego należy wyłączyć urządzenie i pozostawić je do ostygnięcia przez co najmniej 10 minut.
- Niezastosowanie dołączonego modelu zasilacza GB-BT może naruszyć zgodność z przepisami i narazić użytkownika na niebezpieczeństwo.

Güvenlik ve Düzenleyici Bilgiler

- Pil yanlış tipte bir pil ile değiştirilirse patlama riski ortaya çıkar. Piller, mümkünse geri dönüştürülmelidir. Kullanılmış Piller yerel çevre yasalarına uygun olarak atılmalıdır.
- Dahili bir parçayı değiştirmek için kasayı açmadan önce cihazı kapatmanız ve en az 10 dakika soğumasını beklemeniz gerekir.
- GB-BT Model Güç Adaptörünün kullanılmaması yasalara uygunluğu ihlal eder ve kullanıcıyı güvenlik riskine maruz bırakır.

安全與規範資訊

- 若以不正確類型的電池進行更換，可能會有爆炸的危險。應儘可能回收電池。應依照當地環保法規棄置使用過的電池。
- 打開機殼更換內部元件前，必須先關閉裝置電源，並讓裝置降溫至少10分鐘。
- 若未使用隨附的 GB-BT 型號電源變壓器，可能會違反規範合規性，並讓使用者暴露在危險中。

安全与法规信息

- 以不正确类型的电池进行更换，有可能发生爆炸的危险。应承担电池回收的风险。按照当地规定弃置使用过的电池。
- 在打开机箱更换内部组件之前，需要先关闭设备电源，并让设备冷却至少10分钟。
- 不使用随附的 GB-BT 型号电源适配器可能违反法规要求，且可能让用户面临危险。

安全および規制に関する情報





- 誤ったタイプのバッテリーに交換すると、爆発の危険があります。バッテリーは可能な限りリサイクルしてください。使用済みバッテリーの廃棄は地域の規制を遵守する必要があります。
- 内部部品を交換するためにシャーンを開ける前に、デバイスの電源をオフにして少なくとも10分間冷却する必要があります。
- 付属のモデルGB-BT電源アダプタをご使用にならない場合、規制違反となる場合があります、安全上の危険が生じる恐れがあります。

안전 및 규제 정보

- 배터리를 올바르게 알지 않은 유형으로 교체할 경우 폭발의 위험이 있습니다. 배터리는 가능한 한 재활용해야 합니다. 폐배터리는 현지 환경 규제에 따라 폐기해야 합니다.
- 배터리를 올바르게 알지 않은 유형으로 교체할 경우 폭발의 위험이 있습니다. 배터리는 가능한 한 재활용해야 합니다. 폐배터리는 현지 환경 규제에 따라 폐기해야 합니다.
- 포함된 모델 GB-BT 전원어댑터를 사용하지 않으면 규제준수를 위반할 수 있으며 사용자가 안전 위험에 노출될 수 있습니다。

Conventions

The following conventions are used in this user's guide:

	NOTE! Gives bits and pieces of additional information related to the current topic.
	CAUTION! Gives precautionary measures to avoid possible hardware or software problems.
	WARNING! Alerts you to any damage that might result from doing or not doing specific actions.
	Languages This icon indicates the text is translated to different languages.

Symbol Statement



At the end of its serviceable life, this product should not be treated as household or general waste. It should be handed over to the applicable collection point for the recycling of electrical and electronic equipment, or returned to the supplier for disposal.



This device complies with part 15 of the FCC Rules. Operation is subject to the following two conditions: (1) This device may not cause harmful interference, and (2) this device must accept any interference received, including interference that may cause undesired operation.



CAUTION! Hot Surface. Do not touch. / **VORSICHT!** Heiße Oberfläche. Nicht berühren./

ATTENTION! Surface chaude. Ne pas toucher. / **PRECAUCIÓN!** Superficie caliente. No tocar./

CUIDADO! Superficie quente. Não tocar. / **ATTENZIONE!** Superficie calda. Non toccare./

ОСТОРОЖНО! Горячая поверхность. Не прикасайтесь. / **OSTRZEŻENIE!** Gorąca powierzchnia. Nie dotykać./

DIKKAT! Sıcak Yüzey. Dokunmayın. / **注意!** 高温表面請勿觸碰 / **警告!** 表面灼热請勿触摸 /

注意! 表面が熱くなっています。触れないでください。 / **경고!** 표면이 뜨겁습니다. 만지지 마십시오



The terms HDMI and HDMI High-Definition Multimedia Interface, and the HDMI Logo are trademarks or registered trademarks of HDMI Licensing LLC in the United States and other countries.

- The statement “Remove and immediately recycle or dispose of used batteries according to local regulations and keep away from children. Do NOT dispose of batteries in household trash or incinerate.”
- The statement “Even used batteries may cause severe injury or death.”
- The statement “Call a local poison control center for treatment information.”
- A statement indicating the compatible battery type (CR2032).
- A statement indicating the nominal battery voltage (3Vdc).
- The statement “Non-rechargeable batteries are not to be recharged.”
- The statement “Do not force discharge, recharge, disassemble, heat above (manufacturer’s specified temperature rating) or incinerate. Doing so may result in injury due to venting, leakage or explosion resulting in chemical burns.”
- A statement indicating The product contains non-replaceable batteries.



R3H139
RoHS

WARNING

- **INGESTION HAZARD:** This product contains a button cell or coin battery.
- **DEATH** or serious injury can occur if ingested.
- A swallowed button cell or coin battery can cause **Internal Chemical Burns** in as little as **2 hours**.
- **KEEP** new and used batteries **OUT OF REACH OF CHILDREN**
- **Seek immediate medical attention** if a battery is suspected to be swallowed or inserted inside any part of the body.

**WARNING****THIS PRODUCT CONTAINS A BUTTON BATTERY**

If swallowed, a lithium button battery can cause severe or fatal injuries within 2 hours.
Keep batteries out of reach of children.
If you think batteries may have been swallowed or placed inside any part of the body, seek immediate medical attention.

- Battery type : CR2032, voltage rating : +3VDC.
- Non-rechargeable batteries are not to be recharged.
- Remove and immediately recycle or dispose of used batteries, batteries from equipment not used for an extended period of time according to local regulations and keep away from children. DO NOT dispose of batteries in household trash or incinerate.
- Even used batteries may cause severe injury or death.
- Do not force discharge, recharge, disassemble, heat above (manufacturer's specified temperature rating) or incinerate. Doing so may result in injury due to venting, leakage or explosion resulting in chemical burns.
- For treatment information, call a local poison control center.
- The product contains non-replaceable batteries.

單元 Unit	限用物質及其化學符號 Restricted substances and its chemical symbols					
	鉛 Lead (Pb)	汞 Mercury (Hg)	鎘 Cadmium (Cd)	六價鉻 Hexavalent chromium (Cr ^{VI})	多溴聯苯 Polybrominated biphenyls (PBB)	多溴二苯醚 Polybrominated diphenyl ethers (PBDE)
電路板總成	—	○	○	○	○	○
散熱器(含風扇)	○	○	○	○	○	○
無線網路卡	—	○	○	○	○	○
線材	—	○	○	○	○	○
外殼	○	○	○	○	○	○
電源供應器	—	○	○	○	○	○

備考1: "超出0.1 wt%"及"超出0.01 wt%"係指限用物質之百分比含量超出百分比含量基準值。

Note 1: "Exceeding 0.1 wt%" and "exceeding 0.01 wt%" indicate that the percentage content of the restricted substance exceeds the reference percentage value of presence condition.

備考2: "○"係指該項限用物質之百分比含量未超出百分比含量基準值。

Note 2: "○" indicates that the percentage content of the restricted substance does not exceed the percentage of reference value of presence.

備考3: "—"係指該項限用物質為排除項目。

Note 3: The "-" indicates that the restricted substance corresponds to the exemption.

報驗義務人: 技宸股份有限公司

Table of Contents

Chapter 1 System Information	14
1-1 Installation Precautions	14
1-2 Product Specifications	15
1-3 Package Contents	17
1-3-1 GB-BT Bare-bone	17
1-3-2 65W Adapter & Power Cord (19 Vdc, 3.42 A)	18
1-3-3 Quick Start Guide	18
1-3-4 VESA Mount Bracket & 6 x Screws	18
1-3-5 Wire Clamp Screw	19
1-3-6 M2 Heatsink	19
1-3-7 HDD/SSD Screws x 4	19
Chapter 2 System Appearance	20
2-1 Front View	20
2-2 Rear View	21
2-3 Left View	22
2-4 Right View	22
2-5 Bottom View	23
2-6 PIN Definition	24
Chapter 3 System Hardware Installation	25
3-1 Removing the Bottom Cover	26
3-2 Installing the M.2 SSD	27
3-3 Installing the Memory	28
3-4 Remove the Wireless Module	29
3-5 Installing the VESA Bracket	30
3-6 Support 2.5" HDD / SSD	31
Chapter 4 BIOS Setup	32
4-1 USB Power On Function	32

Chapter 1 System Information

1-1 Installation Precautions

The system contains numerous delicate electronic circuits and components which can become damaged as a result of electrostatic discharge (ESD). Prior to installation, carefully read the user manual and follow these procedures:













- Prior to installation, do not remove or break motherboard S/N (Serial Number) sticker or warranty sticker provided by your dealer. These stickers are required for warranty validation.
- Always remove the AC power by unplugging the power cord from the power outlet before installing or removing the motherboard or other hardware components.
- When connecting hardware components to the internal connectors on the motherboard, make sure they are connected tightly and securely.
- When handling the motherboard, avoid touching any metal leads or connectors.
- It is best to wear an electrostatic discharge (ESD) wrist strap when handling electronic components such as a motherboard, CPU or memory. If you do not have an ESD wrist strap, keep your hands dry and first touch a metal object to eliminate static electricity.
- Prior to installing the motherboard, please have it on top of an antistatic pad or within an electrostatic shielding container.
- Before unplugging the power supply cable from the motherboard, make sure the power supply has been turned off.
- Before turning on the power, make sure the power supply voltage has been set according to the local voltage standard.
- Before using the product, please verify that all cables and power connectors of your hardware components are connected.
- To prevent damage to the motherboard, do not allow screws to come in contact with the motherboard circuit or its components.
- Make sure there are no leftover screws or metal components placed on the motherboard or within the computer casing.
- Do not place the computer system on an uneven surface.
- Do not place the computer system in a high-temperature environment.
- Turning on the computer power during the installation process can lead to damage to system components as well as physical harm to the user.
- If you are uncertain about any installation steps or have a problem related to the use of the product, please consult a certified computer technician.







1-2 Product Specifications



NOTE:

We reserve the right to make any changes to the product specifications and product-related information without prior notice.

 System Dimension	<ul style="list-style-type: none">◆ 113 x 116.52 x 56.22 mm, 0.67 L◆ Motherboard size: 154 x 109 mm
 CPU	<p><u>GB-BTIP-N150</u> Intel® Processor N150 4C, up to 3.6 GHz, 6W</p> <p><u>GB-BTIP-N250</u> Intel® Processor N250 4C, up to 3.8 GHz, 6W</p>
 Memory	<ul style="list-style-type: none">◆ 1 x SO-DIMM DDR5 slot◆ 4800MHz◆ Max. 16GB
 LAN	<ul style="list-style-type: none">◆ GbE LAN (Realtek RTL8111H)
 Graphics	<ul style="list-style-type: none">◆ Intel® Graphics 24EUs / 32EUs
 Wifi Card	<ul style="list-style-type: none">◆ AW-CB515NF◆ Wi-Fi 5 ; 802.11 a/b/g/n/ac WLAN 1T1R with Bluetooth 5.0
 Audio	<ul style="list-style-type: none">◆ Realtek ALC897
 Storage	<ul style="list-style-type: none">◆ 1 x 2.5" slot for SATA HDD/SSD
 Expansion Slots	<ul style="list-style-type: none">◆ 1 x M.2 2280 slot for SSD (PCIe Gen 3x2)◆ 1 x M.2 2230 slot for WiFi + Bluetooth card
 HDMI Resolution (Max.)	<ul style="list-style-type: none">◆ HDMI 2.0◆ Support 4K@60P HDR10
 VESA	<ul style="list-style-type: none">◆ VESA Mounting Hole◆ Supports 75 x 75 and 100 x 100 mm
 Front I/O	<ul style="list-style-type: none">◆ 1 x Power Button◆ 1 x USB 3.2 Gen2 Type-A◆ 1 x USB 3.2 Gen2 with Type-C DP◆ 1 x Headphone◆ 1 x Microphone

	Rear I/O	<ul style="list-style-type: none"> ◆ 1 x HDMI ◆ 1 x GbE RJ45 ◆ 2 x USB 3.2 Gen2 Type-A ◆ 1 x USB 3.2 Gen2 with Type-C DP ◆ 1 x Wire Clamp Screw Hole
	Left I/O	<ul style="list-style-type: none"> ◆ 1 x DC-In
	Right I/O	<ul style="list-style-type: none"> ◆ 1 x Kensington lock slot
	Power Supply	<ul style="list-style-type: none"> ◆ Input: AC 100-240V ◆ Output: DC 19V/3.42A, 65W
	Support OS	<ul style="list-style-type: none"> ◆ Win11 64 bits
	Environment	<ul style="list-style-type: none"> ◆ Operating Temperature 0°C to 35°C ◆ Storage Temperature -20°C to +60°C

1-3 Package Contents



Lieferumfang / Contenu du colis / Contenido del paquete / Conteúdo da embalagem /
Contenuto della confezione / Комплект поставки / Zawartość opakowania / Paket içeriği /
包裝內容物 / 包装内容 / 同梱品 / 패키지 포함 물품

1-3-1 GB-BT Bare-bone



- NOT Include any of the following: M.2 (2280), SO-DIMM memory
- Folgendes ist NICHT enthalten: M.2 (2280), SO-DIMM Arbeitsspeicher
- N'inclut PAS les éléments suivants : M.2 (2280), mémoire SO-DIMM
- NO incluye lo siguiente: M.2 (2280), memoria SO-DIMM
- NÃO inclui nenhum dos seguintes: M.2 (2280), memória SO-DIMM
- NON comprende alcuno dei seguenti componenti: Memoria M.2 (2280), Memoria SO-DIMM
- НЕ включает: Модули памяти M.2 (2280), 2,5-дюйм накопитель, SO-DIMM модули ОЗУ
- NIE obejmuje żadnego z poniższych: M.2 (2280), pamięć SO-DIMM
- Aşağıdakilerin hiçbiri dahil DEĞİLDİR: M.2 (2280), SO-DIMM hafıza
- 不包含下列任何項目：M.2 (2280)、SO-DIMM 記憶體
- 不含以下物品：M.2 (2280)、SO-DIMM 內存
- 次は含まれていません：M.2 (2280)、SO-DIMMメモリ
- 다음 물품은 포함되어 있지 않습니다: M.2(2280), SO-DIMM 메모리

1-3-2 65W Adapter & Power Cord (19 Vdc, 3.42 A)



The product should be used with the included power cord. The included power cord should not be used with other products.

製品には、同梱された電源コードセットを使用すること。同梱された電源コードセットは、他の製品に使用しないこと。

1-3-3 Quick Start Guide



1-3-4 VESA Mount Bracket & 6 x Screws

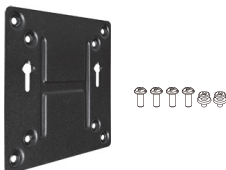

1-3-5 Wire Clamp Screw



1-3-6 M2 Heatsink



1-3-7 HDD/SSD Screws x 4



Chapter 2 System Appearance



Getting Familiar with Your Unit

Erste Schritte mit Ihrem Gerät / Se familiariser avec votre appareil / Familiarizándose con su unidad / Familiarizar-se com a unidade / Imparare a conoscere la propria unità / Знакомство с изделием / Zapoznanie się z jednostką / Cihazınız Hakkında Bilgi Sahibi Olun / 認識您的裝置 (※系統操作溫度 0°C~35°C) / 了解您的设备 (※系統操作溫度 0°C~35°C) / ユニットを知る / 기기에 대해 알아보기

2-1 Front View

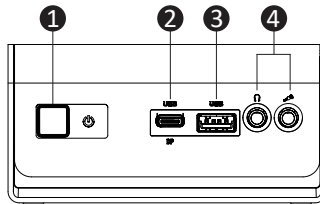

No.	Description
1.	Power Button (電源按鈕)
2.	USB 3.2 Gen2 Type-C with DisplayPort 1.4(10Gbps)(5V/2A)
3.	USB 3.2 Gen2 Type A (10Gbps)(5V/1A)
4.	Headphone/Microphone (耳機/麥克風)

2-2 Rear View

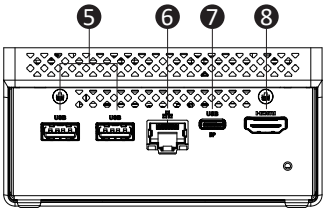

No.	Description
5.	USB 3.2 Gen2 Type A (10Gbps)(5V/1A)
6.	RJ-45 (10/100/1000Mbps)
7.	USB 3.2 Gen2 Type-C with DisplayPort 1.4(10Gbps)(5V/2A)
8.	HDMI 2.0 4K(3840 x 2160) 60Hz

2-3 Left View

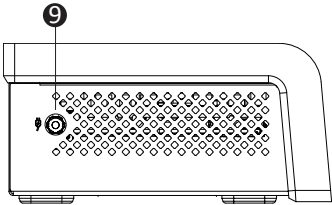

No.	Description
9.	DC-In (電源輸入)

2-4 Right View

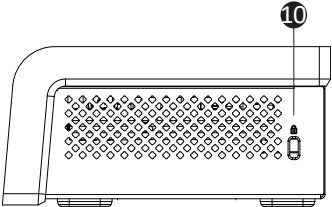

No.	Description
10.	Kensington Lock Slot (防盜鎖槽)

2-5 Bottom View

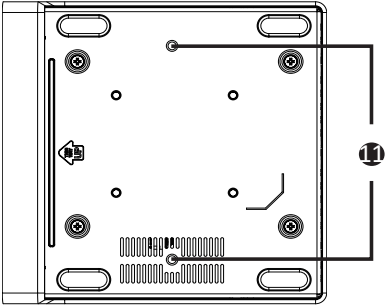

No.	Description
11.	VESA Screw Hole (支架螺絲孔)

2-6 PIN Definition

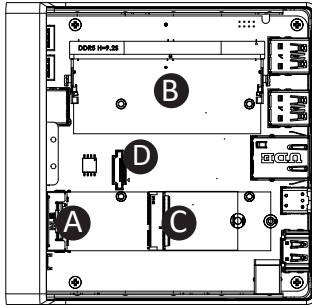

PIN Definition	
A	M.2 2280 SSD Connector
B	DDR SO-DIMM slot
C	Wi-Fi Connector
D	SATA SSD/HDD Connector



NOTE! Wireless module inclusion may vary based on local distribution.

注意：根据各地经销商之产品规格配置，有些市场将不提供预载的无线模块。

Chapter 3 System Hardware Installation



Pre-installation Instructions

Computer components and electronic circuit boards can be damaged by electrostatic discharge. Working on computers that are still connected to a power supply can be extremely dangerous. Follow the simple guidelines below to avoid damage to your computer or injury to yourself.

- Always disconnect the computer from the power outlet whenever you are working inside the computer case.
- If possible, wear a grounded wrist strap when you are working inside the computer case. Alternatively, discharge any static electricity by touching the bare metal system of the computer case, or the bare metal body of any other grounded appliance.
- Hold electronic circuit boards by the edges only. Do not touch the components on the board unless it is necessary to do so. Do not flex or stress the circuit board.
- Leave all components inside the static-proof packaging until you are ready to use the component for the installation.

3-1 Removing the Bottom Cover



Before you remove the bottom cover

- Make sure the system is not turned on or connected to AC power.

Follow these instructions to remove/install the Bottom Cover:

1. Unscrew and remove the bottom cover from system.
(將底蓋從機器上移除。)

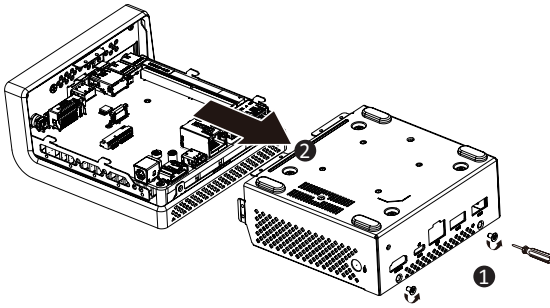

2. Reinstall the bottom cover to system.
(將底蓋鎖回機器上。)

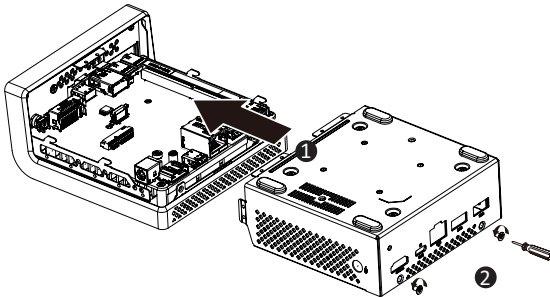

3-2 Installing the M.2 SSD



M.2 SSD: Installation der M.2 2280 SSD / SSD M.2 : Comment installer le SSD M.2 2280 / SSD M.2: Como instalar el SSD M.2 2280 / M.2 SSD: Como instalar o M.2 2280 SSD / SSD M.2: Come installare l'SSD M.2 2280 / M.2 SSD: Установка модуля M.2 2280 SSD / M.2 SSD: Instalacja dysku SSD M.2 2280 / M.2 SSD: M.2 2280 SSD nasıl yüklenir / M.2 SSD : M.2 2280 SSD 安裝方式 / M.2 SSD : 如何安装 M.2 2280 SSD / M.2 SSD : M.2 2280 SSD의インストール方法 / M.2 SSD: M.2 2280 SSD 설치 방법



WARNING!

Failure to properly turn off the system before you start installing components may cause serious damage.

Follow these instructions to Install the M.2 SSD:

1. Remove both the small screw secured to the M.2 SSD screw hole.
(取下 M.2 SSD 插槽螺絲孔上的螺絲。)
2. Carefully insert the M.2 SSD into slot.
(小心地把 M.2 SSD 裝入 插槽。)
3. Insert the tab on the thermal plate into the slit near the connector, then secure the thermal plate and M.2 SSD in place with the previously removed screw.
(把散熱片裝入插槽旁邊的缺口，然後用之前取下的螺絲將 M.2 SSD 與散熱片固定。)

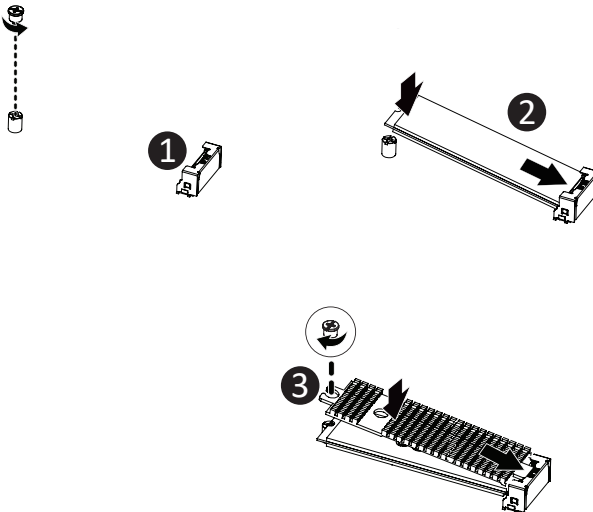

NOTE!

The illustrations of the M.2 SSD/Heatsink installation shown are for reference only. Please follow the installation steps of actual purchased.

注意! 安裝 M.2 SSD / 散熱片 圖示僅參考，請依照實際購買的 M.2 SSD / 散熱片安裝步驟說明。

3-3 Installing the Memory



Arbeitsspeicher Installation: SO-DIMM DDR5 / Installation de la mémoire : SO-DIMM DDR5 / Instalación de la memoria: SO-DIMM DDR5 / Instalação de memória: SO-DIMM DDR5 / Installazione della memoria: SO-DIMM DDR5 / Установка модулей памяти: SO-DIMM DDR5 / Instalacja pamięci: SO-DIMM DDR5 / Hafıza Yüklemesi: SO-DIMM DDR5 / 安裝記憶體：SO-DIMM DDR5 / 内存安装：SO-DIMM DDR5 / メモリインストール：SO-DIMM DDR5 / 메모리 설치: SO-DIMM DDR5



Read the following guidelines before you begin to install the memory:

- Make sure that the system supports the memory. It is recommended that memory of the same capacity, brand, speed, and chips be used.
- Always turn off the computer and unplug the power cord from the power outlet before installing the memory to prevent hardware damage.
- Memory modules have a foolproof design. A memory module can be installed in only one direction. If you are unable to insert the memory, switch the direction.

Follow these instructions to Install the Memory(SO-DIMM DDR5):

1. Carefully insert SO-DIMM memory modules.
(小心並由下層至上層安裝 SO-DIMM 記憶體於記憶體插槽。)
2. Push down until the modules click into place.
(當記憶體固定於插槽後，再輕輕下壓至定點。)

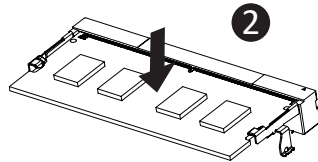
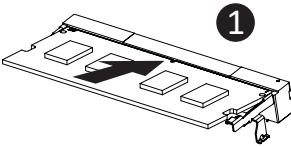

3-4 Remove the Wireless Module



Drahtlosmodul: Sicheres Entfernen des Moduls / Module sans fil : Comment retirer le module en toute sécurité / Módulo inalámbrico: Cómo quitar el módulo de forma segura / Módulo sem fios: Como remover com segurança o módulo / Modulo senza cavi: Come rimuovere il modulo in sicurezza / Беспроводной модуль: Безопасное отсоединение модуля / Modul bezprzewodowy: Bezpieczne usuwanie modulu / Kablosuz Modül: Modül Güvenli Bir Şekilde nasıl Çıkarılır / 無線模組: 安全移除模組的方式 / 无线模块: 如何安全移除模块 / ワイヤレスモジュール: モジュールの安全な取り外し方法 / 무선 모듈: 모듈을 안전하게 제거하는 방법

Follow these instructions to remove the WiFi Module:

1. Disconnect the two antennas by manually lifting off the clips that hold them in place.
(向上移除連接於無線模組左側頂端天線。)
2. Remove the screw in the middle.
(鬆開固定於無線模組中央頂端的螺絲。)
3. Carefully pull the wireless module from the slot.
(小心的把無線模組從M.2插槽拔除。)

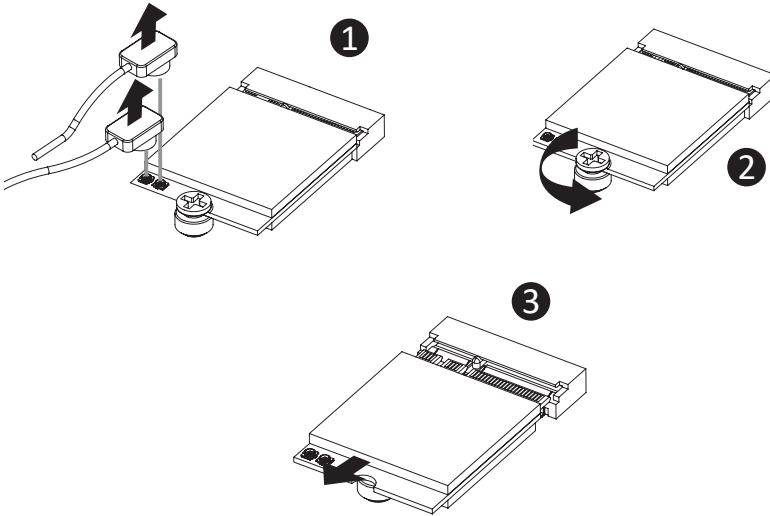

NOTE!

依據低功率電波輻射性電機管理辦法【第十二條】經型式認證合格之低功率射頻電機，非經許可公司、商號或使用者均不得擅自變更頻率、加大功率或變更原設計之特性及功能。【第十四條】低功率射頻電機之使用不得影響飛航安全及干擾合法通信；經發現有干擾現象時，應立即停用，並改善至無干擾時方得繼續使用。前項合法通信指依電信法規定作業之無線電通信。低功率射頻電機須忍受合法通信或工業、科學及醫療用電波輻射性電機設備之干擾。」

3-5 Installing the VESA Bracket



VESA Halterung / Support VESA / Soporte VESA / Suporte VESA / Staffa VESA / Кронштейн VESA / Wspornik VESA / VESA Braketi / VESA 支架 / VESA 支架 / VESA ブラケット / VESA 브래킷

Follow these instructions to install the VESA Bracket:

1. Attach the screws on the underside of the system.
(安裝 VESA 支撐架螺絲於系統底部。)
2. Attach the VESA mounting plate to the rear of a compatible display using the screws provided.
(安裝 VESA 支撐架於支援 VESA 支撐架的電腦螢幕或電視機後背。)
3. The system can now be mounted by sliding the device into place.
(將已安裝 VESA 支撐螺絲的系統插入 VESA 支撐架的滑軌孔，向下壓至定位點後即可固定。)

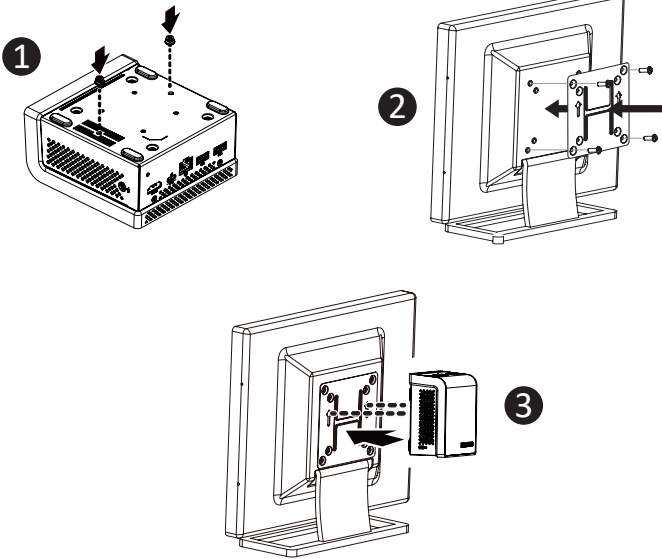

NOTE!

The illustrations of the VESA bracket installation shown are for reference only. Please follow the installation steps of actual purchased bracket.

注意! 安裝 VESA 支撐架圖示僅參考，請依照實際購買的支架安裝步驟說明。

3-6 Support 2.5" HDD / SSD

Follow these instructions to install the 2.5" HDD/SSD:

1. Unscrew and remove the bottom cover.
(將底蓋從機器上移除。)
2. Install the HDD / SSD on the bottom panel and secure with four screws provided, then connect the cable to the HDD / SSD.
(用隨附的四顆螺絲將HDD / SSD固定於底蓋，並將傳輸線連接於HDD / SSD。)
3. Reinstall the bottom cover with HDD / SSD to system.
(將裝有HDD / SSD的底蓋鎖回機器上。)

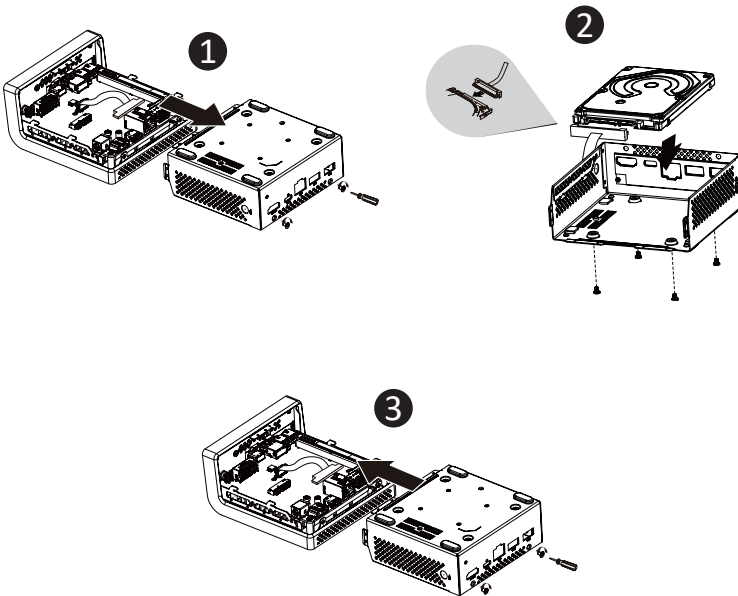

NOTE!

Please check the cable is well connected to the SATA connector on the motherboard.
注意! 請確認傳輸線是否以正確連接到主板上的SATA接頭。

Chapter 4 BIOS Setup

4-1 USB Power On Function

Allows Device Power-on Via USB. Useful When Mounted Behind a Display or TV



USB Power On Funktion / Fonction Démarrage par USB / Función USB Power On / Função USB Power On / Funzione USB Power On / Функция USB Power On / Opcja USB Power On / USB Güç Açık Fonksiyonu / USB 埠啟動功能 / USB 接口启动功能 / USB 機器からの電源 ON 機能 / USB 포트를 이용한 전원 켜기

Follow these instructions to enable USB Power On:

1. Press “Del” during device start up to enter BIOS.
(開機後按啟 Del 鍵進入 BIOS 設定畫面)
2. Select “Chipset” from the menu.
(在 BIOS 主選單選取 “Chipset”)
3. Manually configure “USB S5 Wakeup Support” settings to “Enable”.
(進入 Chipset 的 USB S5 Wakeup Support 選項，手動控制將其 “Enable”)
4. Press F4 to Save and Exit.
(按啟 F4 存儲設定並離開 BIOS 選單重新開機)

