

GIGABYTE™

Multilingual Installation Guide

S55U



Read this manual carefully before you use this machine and keep it handy for future reference. For safe and correct use, be sure to read the Safety Precautions in the User's Manual before using the machine.

The photos are for reference only. Specifications may vary by model.

We endeavor to present the most accurate and comprehensive information at the time of publication, we reserve the right to make changes without prior notice.

This Multilingual Installation Guide supports the following model:

S55U

Table of Contents

What's in the box	2
Getting started	3
Step 1. Attach stand or mount.....	3
Step 2. Connect devices to your monitor	6
Step 3. Get to know controls.....	9
Step 4. Power on the monitor	12
Step 5. Complete the first-time setup.....	12
Step 6. Establish a network connection	12
Step 7. Enjoy your monitor!	13
Product specifications.....	14
Certification and compliance	15

What's in the box

Your Gigabyte monitor comes with the following items:

- monitor
- remote control
- 2 base stands
- 1 HDMI cable
- warranty card
- power cord
- 1 set of AAA(1.5Vcc) batteries
- 4 screws (M5×16)
- Multilingual Installation Guide (this document)
- Regulatory Notices & Safety Precautions

IMPORTANT:

To prevent accidentally discarding items that came with your monitor, be sure to **check ALL of the foam** in the carton box.

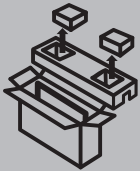

- Please check foam for accessories before discarding.
- Veuillez vérifier la mousse pour qu'il n'y ait pas d'accessoires avant de la jeter.
- Antes de desechar la espuma, asegúrese de retirar todos los accesorios.

You will also need the following items (which are not included) to set up your monitor:

- Wireless router (not included) for Internet connectivity
- Phillips screwdriver (not included) to secure the monitor stand
- Not all connection cables are included. Some cables are sold separately to connect external devices to the monitor.
- Wall mount bracket and screws (not included) if you prefer to mount the monitor on the wall

Disclaimer: This Multilingual Installation Guide is intended as a general guideline to help you set up your monitor. Images throughout this document are for illustrative purposes only and might differ from the actual product.

Getting started

Step 1. Attach stand or mount

Before you start using your monitor, attach your monitor stand or mount it on the wall.

CAUTION:

- Disconnect the AC power cord before installing a stand or a wall mount bracket.
- The LED display on your monitor is fragile. Make sure the monitor screen is not scratched or damaged by hard objects or from pressure.
- After the installation is complete, make sure the monitor is steady on a table or firmly attached to a wall mount, before removing all protective film, if any.

Attach the monitor stand

To attach the monitor stand legs to your monitor:

1. Carefully place your monitor face down on a clean, soft and flat surface.
2. Insert the monitor base stands into the bottom slots on your monitor.
3. Use the screws provided to secure each base stand tightly.

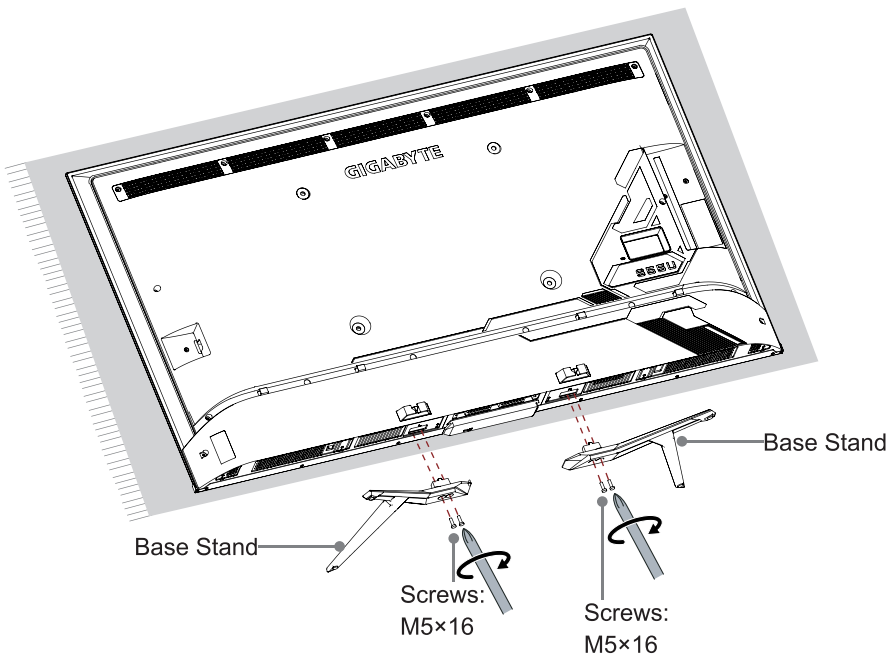

Attach the wall mount bracket (not included)

Before you begin the third-party manufacturer instructions, be sure to do the following things:

1. Place the monitor face down on a clean, safe and cushioned surface.
2. Remove the monitor stand if you have already attached it.
3. Remove the four screws on the back of the monitor.

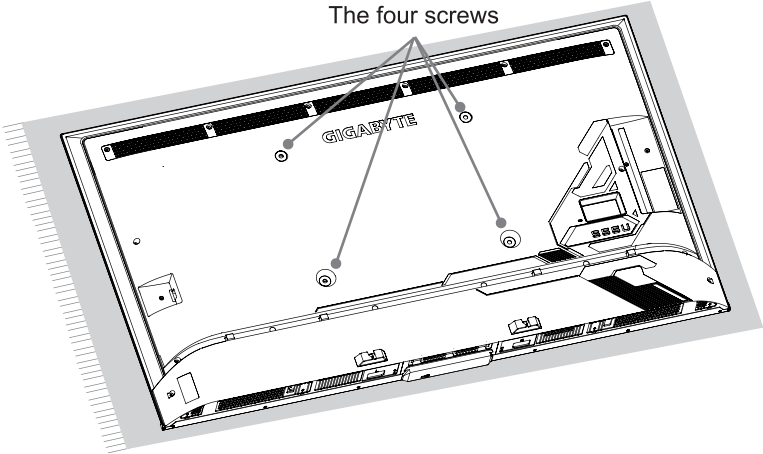

4. Place spacers (not included) in the corresponding bracket holes.

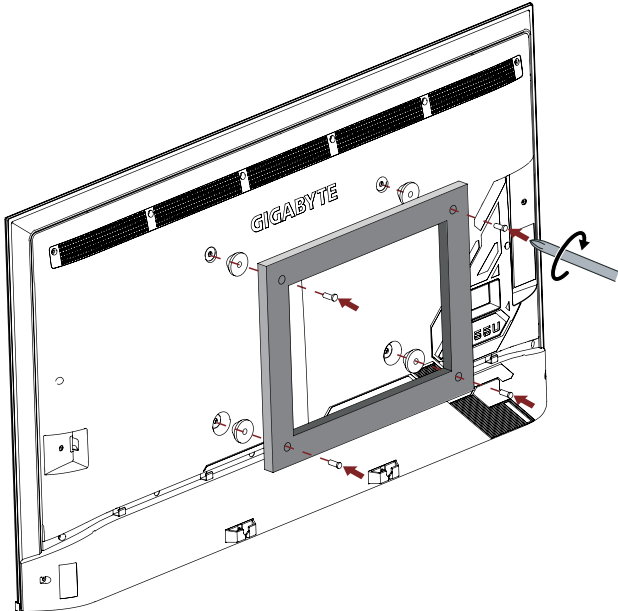

CAUTION:

- Follow instructions provided with the wall mount bracket. If it is not correctly mounted, the monitor may fall and cause property damage or personal injury.
- When you attach the mount, be sure to use spacers (provided by the third-party manufacturer) between the monitor and the bracket.
- To prevent internal damage to the monitor and to ensure it is mounted securely, be sure to use fixing screws (not included) that are 8.0 -10.0 mm in length when measured from the attaching surface of the rear cover.

8.0 -10.0 mm

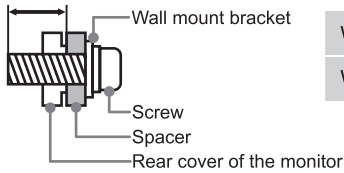

Wall mount hole pattern(mm)	400 × 300
Wall mount screw size	M6

- We do not recommend hanging the monitor on a slanted wall and when wall mounting make sure your monitor remains parallel to the wall and does not lean forward.

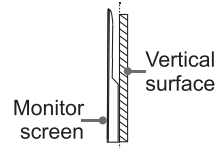









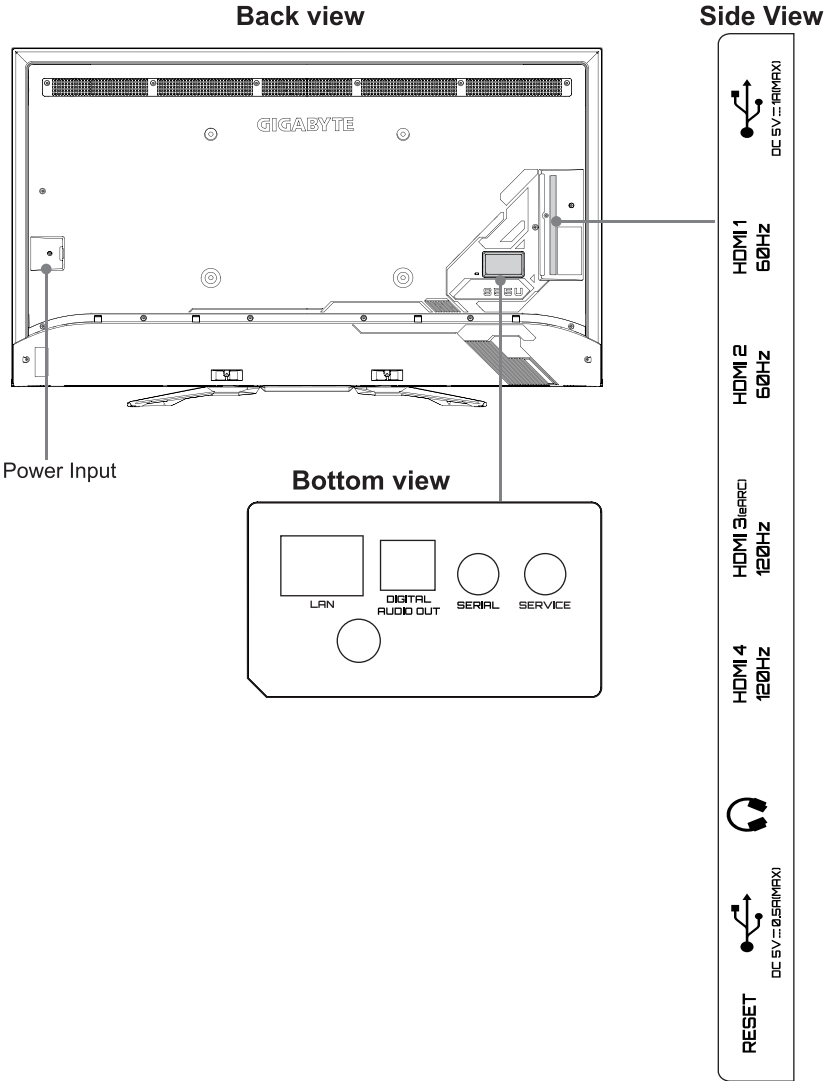





NOTE:





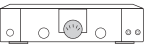
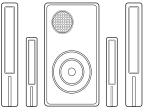



- If you have additional questions, please contact the wall mount manufacturer or the retailer from which you purchased the monitor.
- The diameter and length of the screws differ depending on the wall mount bracket model.

Step 2. Connect devices to your monitor

Check to ensure that you have connected right cables for right ports securely. Loose connections can affect the quality of the picture image and color.



Monitor label	Port	Cable	External equipment	Brief description
HDMI			 <p>VCR</p>  <p>DVD Player/Recorder</p>  <p>Video Camera</p>  <p>Set-top Box</p>  <p>PC Host</p>	<p>Connect a High Definition Multimedia Interface (HDMI) cable from an external device.</p> <p>NOTE1: Only HDMI 3(eARC) Port supports eARC/ARC feature(select Sound > Audio Output > eARC/ARC.) If the device supports eARC function, first select Sound > eARC to set it to On.</p> <p>NOTE2: Only HDMI 3 / 4 Port supports HDMI2.1, If you'd like to use UHD @120Hz Timing, first select Menu > HDMI Format > Enhanced format</p>
DIGITAL AUDIO OUT			 <p>Audio Amplifier</p>  <p>Speaker</p>	<p>Connect an optical cable from an external digital audio system.</p>
			<p>Connect headphones to hear audio from the monitor. Headphones with microphones are not supported.</p>	

Monitor label	Port	Cable	External equipment	Brief description
USB			<p>Connect a USB device for browsing photos, music and movies. The rate of speed of USB 3.0 port 10 times faster than the USB 2.0 port.</p> <p>NOTE: You can still plug a USB 2.0 device into a USB 3.0 port; however, the rate of speed will not be as fast. USB 3.0 devices are also backwards compatible with USB 2.0 ports.</p>	
LAN				<p>Connect an Ethernet cable to access a network or the Internet. The monitor also has a wireless connectivity feature.</p>
SERVICE		<p>This port is not available for you to connect an external device, but can only be used by factory for testing purposes.</p>		
SERIAL		<p>It may be used to connect to a home automation system or Custom Integrated Audio/Video (A/V) system. It is recommended that it only be completed by a professional custom installer.</p>		
RESET		<p>Power off / restart (quick press) Reset your monitor back to the factory setting (long press for 5 seconds)</p>		

Step 3. Get to know controls

Control on the monitor

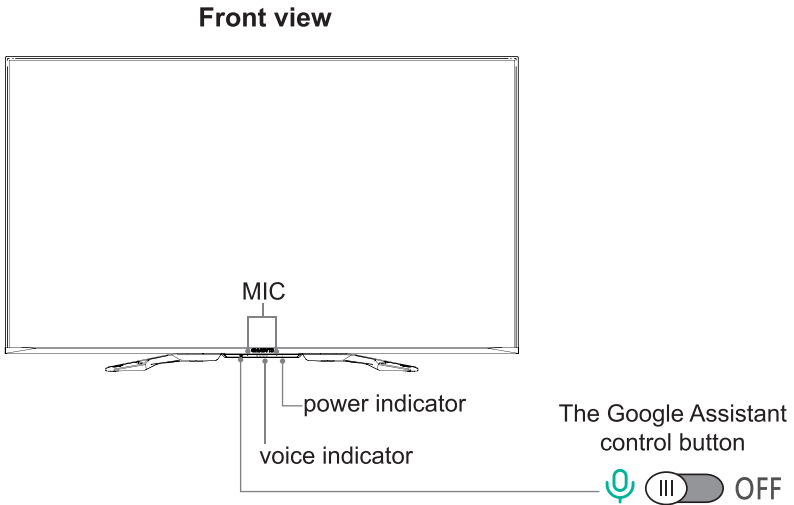

The Google Assistant can answer your questions or help you change monitor configuration.
Before using this function, connect the monitor to the Internet and sign in your Google account at **Settings > Accounts & Sign In**.

- How to use the Google Assistant function via the control button on your monitor:
 1. Switch the button to [] to turn on the Google Assistant.
 2. Start a conversation by saying "Hey Google", and the dialog bar appears at the bottom of the monitor screen. At the same time, voice indicator illuminate.
 3. Continue speaking, such as "What's the weather" or "volume up".











- Screenless Mode

Talk to the Google Assistant even when the screen is off.
In Screenless Mode, the Google Assistant is always available to help even when the screen is not on. Just say "Hey Google".
This feature will affect standby power consumption. To turn it off, go to **Settings > Advanced System > Screenless Mode**

NOTE: The Google Assistant and some features are available on limited country/region/language.

Get your remote ready

The following table shows the buttons on your remote control and describes what they are for.

<i>BUTTON</i>	<i>DESCRIPTION</i>
	Google Assistant Enabled: Power ON/Screenless Mode (quick press)/Power Off (long press) Google Assistant Disabled: Power ON/Standby (quick press)/Power Off (long press)
	Press to display the Home screen Press and hold to display all applications
INPUT	Change monitor input source
	Custom button to launch input or apps quickly
	Custom button to launch input or apps quickly
	Press to enter Menu Press and hold to pair the bluetooth remote
^ / v / < / >	D-pad (up/down/left/right navigation buttons)
OK	Confirmation button
	Return to the previous place in the menu or app
	Google Assistant of monitor
^ VOL v	Volume (up/down)
ON  OFF	Crosshair (on/off)
	Press to Mute or restore sound Press and hold to display Accessibility menu
	Media content control function buttons
P.MODE	Quick access to picture mode
S.MODE	Quick access to sound mode
APP	Quick access buttons to APP

NOTE: Buttons listed here are for reference only. Actual remote control models may vary.

Insert the batteries

1. Take off the back cover to open the battery compartment of the remote control.
2. Insert two AAA(1.5Vcc) size batteries. Make sure to match the (+) and (-) ends of the batteries with the (+) and (-) ends indicated in the battery compartment.
3. Restore the battery compartment cover.

Remote control range information

- The remote control can work at a distance of up to 26 feet (792.5 cm) in front of the monitor set.
- It can work at a 30 degree horizontal or vertical angle.

Pairing the remote control

1. Pair the remote to the monitor after you power it on. Keep the remote control within 10 feet (304.8 cm) from the Monitor. Press and hold the [] button at least 3 seconds to start pairing.
2. If the remote pairs successfully, a confirmation will display on the screen. If it does not pair successfully, an unsuccessful message will display. Repeat step 1.

NOTE:

- If an unknown error occurs with the remote, it could have been caused by interference. Try to remove what's causing the interference and pair the remote again.
- If an unknown error occurs with the remote control while the battery power is normal, you can take out the batteries and press any key for 1~2 seconds, and the remote control can work normally.
- The remote cannot be paired to the monitor while the monitor is in the standby mode.

Step 4. Power on the monitor

Connect your power cord to the monitor and plug it into a power outlet. Your monitor will display a launch screen showing the Gigabyte logo.

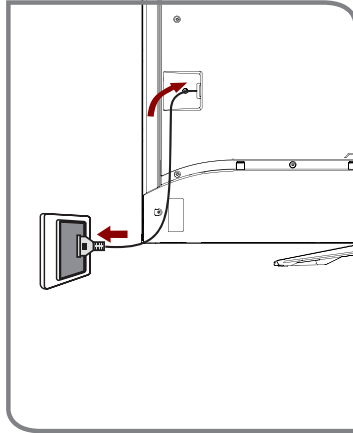

NOTE: S/N refers to the label at the bottom left of the monitor back cover.

Step 5. Complete the first-time setup

The first time you turn on your monitor, there is a guided setup to make it easy to connect your monitor to the Internet and complete the setup of your monitor.

Step 6. Establish a network connection

1. Press the **Home** button on the remote control, and select the  icon to select **Settings** to enter the Settings menu.
2. Select **Network & Internet**.

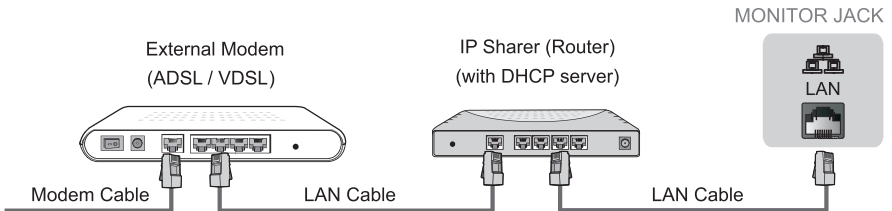

Establish a wired network connection

Automatically obtain an IP address

1. If you connect to the wired network, the monitor will automatically obtain an IP address and connect to the network.

NOTE: The default option of IP Settings Mode is DHCP.

2. If the connection fails, “**Not connected**” will display for the Ethernet status. Retry or enter the **IP settings**, and select **Static** to input the information again.

Manually enter the IP address

1. Enter the **IP settings** to select **Static**.

2. Enter the IP address, Gateway, Network prefix length, DNS 1 and DNS 2 in the menu.

Establish a wireless network connection

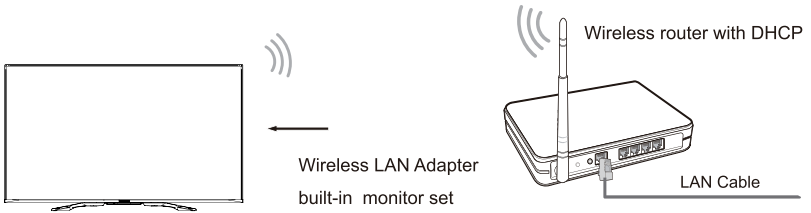

The monitor can directly receive network signals via wireless router.

1. Turn on your Wi-Fi.

2. The list of networks will display automatically.

3. Select a wireless network from the list, input the password.

4. If the network connection does not appear in the list, select **See all** to display all the list, or select **Add new network** to input a Wi-Fi name, select the type of security mode, and enter password.

Close the network connection

Unplug the network cable or turn off your Wi-Fi. The network connection will close.

Step 7. Enjoy your monitor!

Now that you've completed the first-time setup, your Home screen is your starting point for using your monitor. Your Gigabyte monitor provides a variety of entertainment options, so you'll always find something new.

Press the Home button on your remote to get started.

Product specifications

Model Name		S55U
Dimension (W × H × D)	Without Stand	48.5 × 28.2 × 3.9 inches (1232 × 717 × 98 mm)
	With Stand	48.5 × 29.5 × 12.2 inches (1232 × 749 × 309 mm)
Weight	Without Stand	37.3 lbs (16.9 kg)
	With Stand	39.9 lbs (18.1 kg)
Monitor Stand Width(W × D)		29.1 × 12.2 inches (738 × 309 mm)
Class		55" (139.7 cm)
Active Screen Size (Diagonal)		54.6 inches (138.7 cm)
Screen Resolution		3840 × 2160
Audio Power		10 W + 10 W
Power consumption in standby mode		0.5 W
Power consumption		240 W
Power Supply		100-240 V ~ 50/60 Hz
Connectivity		IEEE 802.11 a/b/g/n/ac Bluetooth 5.1
Ports		4 HDMI ports, 1 USB2.0, 1 USB3.0, 1 LAN port for Ethernet (10,100Mbps), 1 Digital Audio Output, 1 Headphone Audio Output, 1 SERIAL port
Operating Temperature		41°F - 95°F(5°C - 35°C)
Operating Humidity		20% to 80% non-condensing
Storage Temperature		5°F to 113°F(-15°C to 45°C)
Storage Humidity		10% to 70%, non-condensing
Atmospheric pressure		86 kPa - 106 kPa
HDMI Input		RGB / 60Hz (640×480, 800×600, 1024×768) YUV / 60Hz (480p, 720p, 1080i, 1080p) YUV / 50Hz (576p, 720p, 1080i, 1080p) 3840×2160 / 24Hz, 3840×2160 / 25Hz, 3840×2160 / 30Hz, 3840×2160 / 60Hz, 3840×2160 / 120Hz, 1920×1080 / 120Hz, 2560×1440 / 60Hz, 2560×1440 / 120Hz, 4096×2160 / 60Hz

Disclaimer: All products, product specifications, and data are subject to change without notice to improve reliability, function, design or otherwise.

Certification and compliance



Dolby, Dolby Vision, Dolby Atmos, and the double-D symbol are registered trademarks of Dolby Laboratories Licensing Corporation. Dolby Vision IQ is a trademark of Dolby Laboratories Licensing Corporation. Manufactured under license from Dolby Laboratories. Confidential unpublished works. Copyright © 2012-2021 Dolby Laboratories. All rights reserved.



For DTS patents, see <http://patents.dts.com>. Manufactured under license from DTS Licensing Limited. DTS, DTS-HD Master Audio, DTS-HD, Virtual:X, and the DTS-HD logo are registered trademarks or trademarks of DTS, Inc. in the United States and other countries. © 2021 DTS, Inc. ALL RIGHTS RESERVED.



The terms HDMI and HDMI High-Definition Multimedia Interface, and the HDMI Logo are trademarks or registered trademarks of HDMI Licensing Administrator, Inc. in the United States and other countries.