

GIGABYTE™

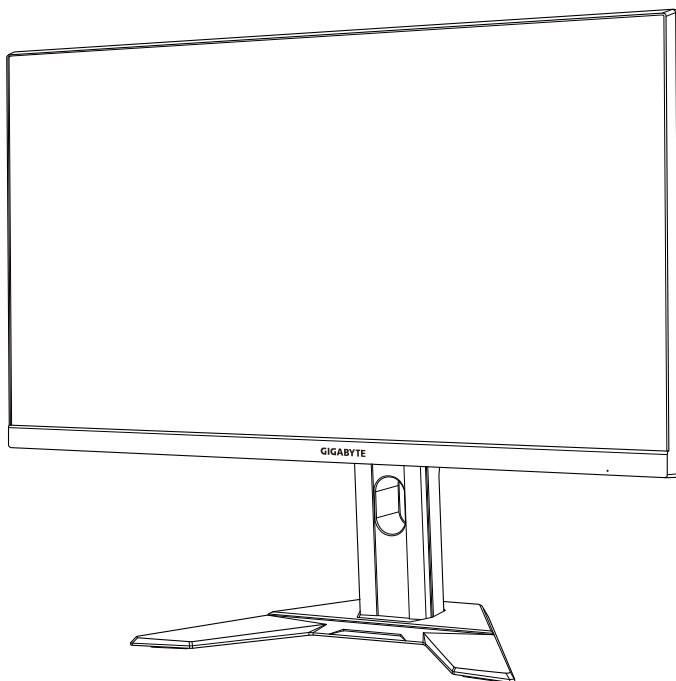

M27U

GAMING MONITOR

USER GUIDE



Copyright

© 2022 GIGA-BYTE TECHNOLOGY CO., LTD. All rights reserved.
The trademarks mentioned in this manual are legally registered to their respective owners.

Disclaimer

Information in this manual is protected by copyright laws and is the property of GIGABYTE.

Changes to the specifications and features in this manual may be made by GIGABYTE without prior notice.

No part of this manual may be reproduced, copied, translated, transmitted, or published in any form or by any means without GIGABYTE's prior written permission.

- In order to assist in the use of this monitor, carefully read the User Guide
- For more information, check on our website at:
<https://www.gigabyte.com>



HIGH-DEFINITION MULTIMEDIA INTERFACE

The terms HDMI and HDMI High-Definition Multimedia Interface, and the HDMI logo are trademarks or registered trademarks of HDMI Licensing Administrator, Inc. in the United States and other countries.

SAFETY PRECAUTIONS

Safety Precautions

Read through the following Safety Precautions before using the monitor.

- Only use the accessories that are provided with the monitor or that which are recommended by the manufacturer.
- Keep the plastic packaging bag for the product in a place that cannot be reached by children.
- Before connecting the monitor to the power outlet, make sure that the voltage rating of the power cable is compatible with the power specification in the country where you are located.
- The power cord plug must be connected to a properly wired and grounded power outlet.
- Do not touch the plug with wet hands, otherwise easily cause electric shock.
- Place the monitor in a stable and well-ventilated place.
- Do not place the monitor near any heat sources such as electric radiators or direct sunlight.
- The holes or openings on the monitor are for ventilation. Do not cover or block the ventilation holes with any objects.
- Do not use the monitor near water, drinks, or all types of liquids. Failure to do so may result in electric shock or damage to the monitor.
- Make sure to unplug the monitor from the power outlet before cleaning.
- As the screen surface is easy to be scratched, avoid touching the surface with any hard or sharp object.
- Use a soft lint-free cloth instead of a tissue to wipe the screen. You may use a glass cleaner to clean the monitor if required. However, never spray the cleaner directly onto the screen.
- Disconnect the power cable if the monitor is not being used for a long period of time.
- Do not attempt to disassemble or repair the monitor yourself.

Stability Hazard Precautions

The product may fall, causing serious personal injury or death. To prevent injury, this product must be securely attached to the floor/wall in accordance with the installation instructions.

Many injuries, particularly to children, can be avoided by taking simple precautions such as:

- ALWAYS use stands or installation methods recommended by the manufacturer of the product set.
- ALWAYS use furniture that can safely support the product.
- ALWAYS ensure the product is not overhanging the edge of the supporting furniture.
- ALWAYS educate children about the dangers of climbing on furniture to reach the product or its controls.
- ALWAYS route cords and cables connected to your product so they cannot be tripped over, pulled or grabbed.
- NEVER place a product in an unstable location.
- NEVER place the product on tall furniture (for example, cupboards or bookcases) without anchoring both the furniture and the product to a suitable support.
- NEVER place the product on cloth or other materials that may be located between the product and supporting furniture.
- NEVER place items that might tempt children to climb, such as toys and remote controls, on the top of the product or furniture on which the product is placed.
- If the existing product is going to be retained and relocated, the same considerations as above should be applied.
- To prevent personal injury or damage to the product caused by tipping over due to earthquakes or other shocks, make sure to install the product in a stable location and take measures to prevent falling.

Contents

SAFETY PRECAUTIONS	3
Safety Precautions	3
Stability Hazard Precautions.	4
INTRODUCTION	6
Unpacking	6
Package Contents.	8
Product Overview	9
GETTING STARTED	11
Installing the Monitor Base	11
Adjusting the Viewing Angle	13
Installing a Wall-Mount Bracket (Optional)	14
Making Connections	15
USING THE DEVICE	16
Turning the Power On/Off	16
User Comfort Recommendations	17
Selecting the Input Source	17
OPERATIONS	18
Quick Menu	18
Configure the Device Settings.	27
APPENDICES	37
Specifications	37
Supported Timing List.	38
Troubleshooting	40
Basic Care.	41
GIGABYTE Service Information	41
SAFETY INFORMATION	43
Regulatory Notices	43

INTRODUCTION

Unpacking

1. Open the upper cover of the packaging box. Then observe the unpacking label attached on the inner cover.
2. Making sure the box is in the correct orientation, carefully lay the box on the stable surface.

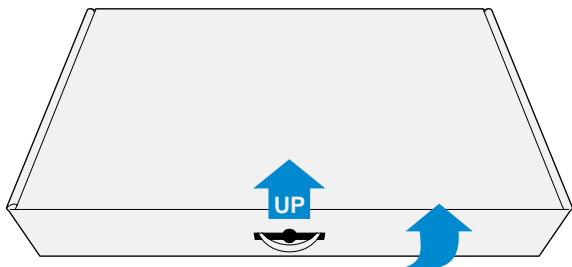

3. Remove the transparent wrapper securing the EPS foams. Then remove the items from the upper EPS foam.

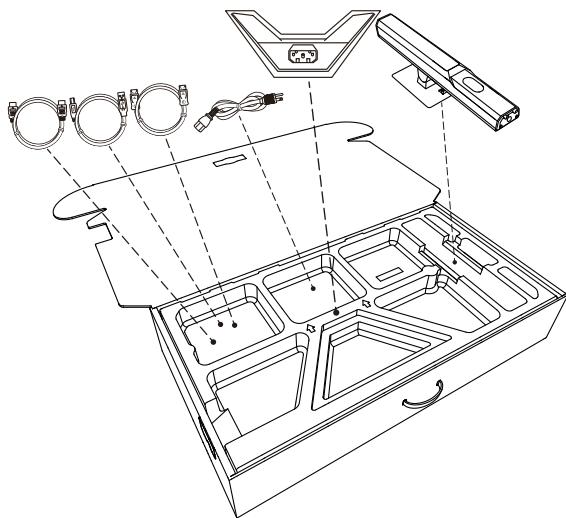

4. Remove the upper EPS foam. Then you can remove the monitor from the lower EPS foam.

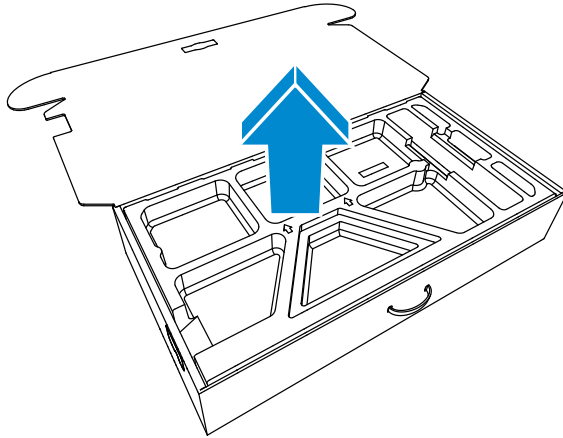

Package Contents

The following items come with your packaging box. If any of them is missing, please contact your local dealer.

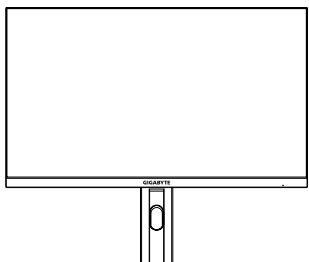

Monitor

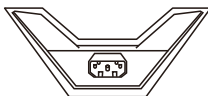

Monitor Base



Power Cable

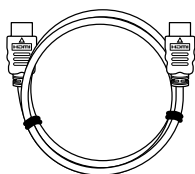

HDMI Cable

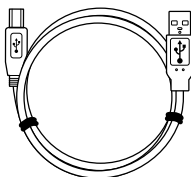

USB Cable

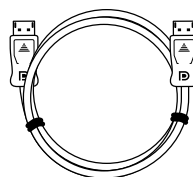

DP Cable

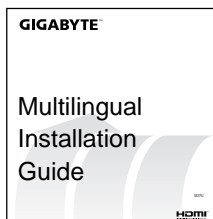

Quick Start Guide



Warranty Card

Note: Please keep the packaging box and packing materials for future transportation of the monitor.

Product Overview

Front view

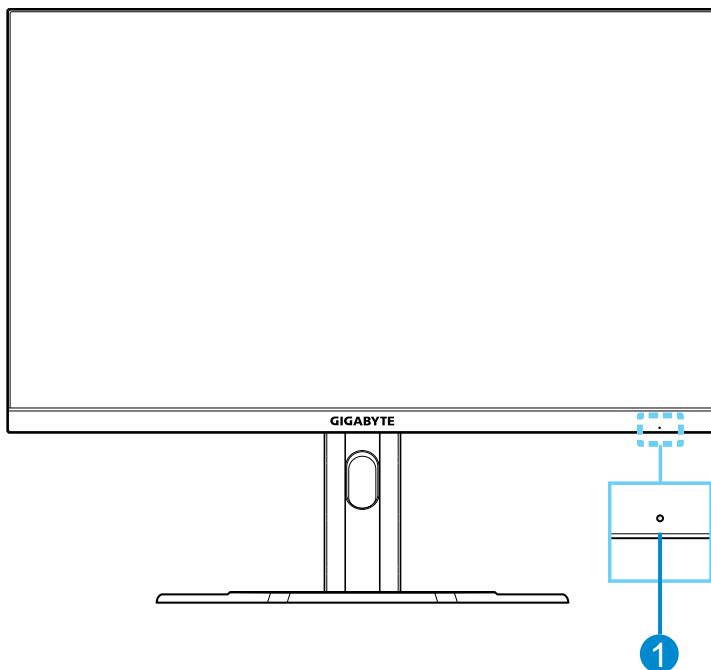

1 Power LED

Rear view

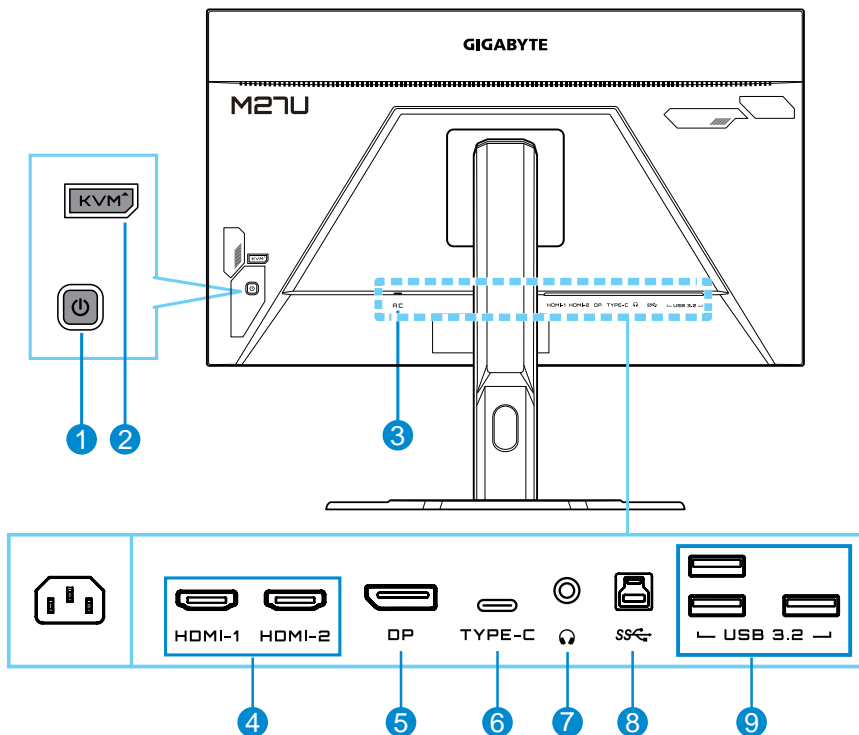

- 1 Control button
- 2 KVM button
- 3 AC Power in
- 4 HDMI ports (x2)
- 5 DisplayPort
- 6 USB Type-C port
- 7 Headphone jack
- 8 USB upstream port
- 9 USB 3.2 ports (x3)

Note:

HDMI™ High-Definition Multimedia Interface are trademarks or registered trademarks of HDMI Licensing LLC.

GETTING STARTED

Installing the Monitor Base

1. Place the monitor on the lower EPS foam, with the screen facing down.
2. Align the monitor base with the standoff underneath the stand. Then attach the base onto the stand.

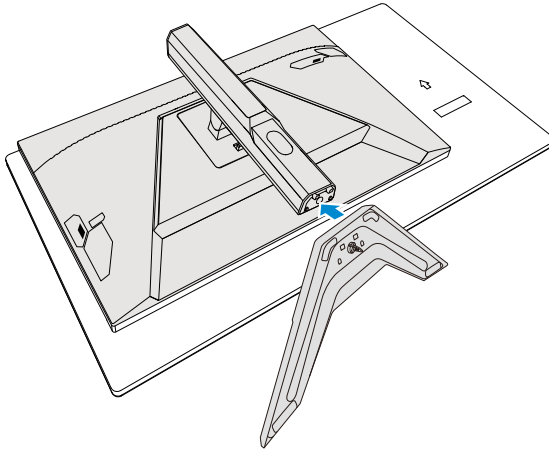

3. Lift the screw ring and turn it clockwise to secure the monitor base in place.

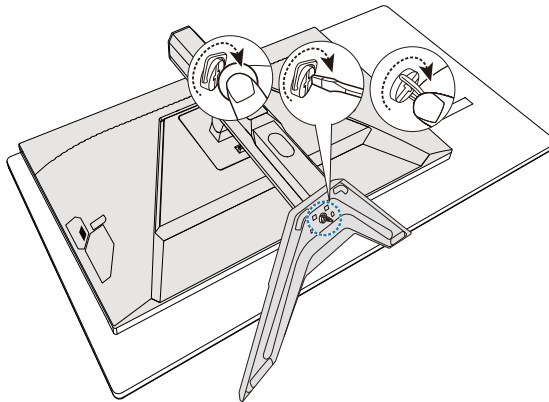

4. Lift the monitor to an upright position and place it on a table.
5. Remove the small block of EPS foam located in between the rear of the screen and the stand. Then remove the safety plate from its slot.

Note: By removing the safety plate, you can now adjust the screen to the desired height.

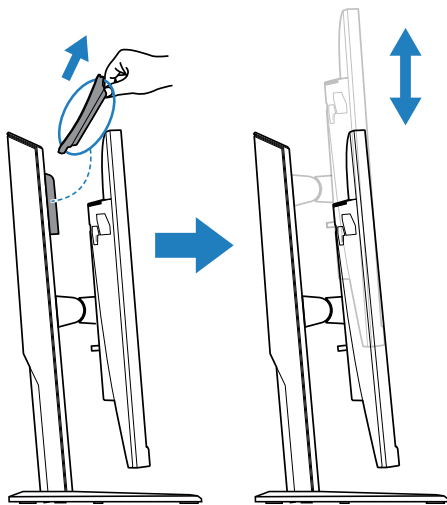

Adjusting the Viewing Angle

Note: Hold the monitor base so that the screen does not topple when you make the adjustment.

Adjusting the Tilt Angle

Tilt the screen forward or backward to the desired viewing angle (-5° to 20°).



Adjusting the Screen Height

Lower or raise the screen to the desired height (0 to 130mm).

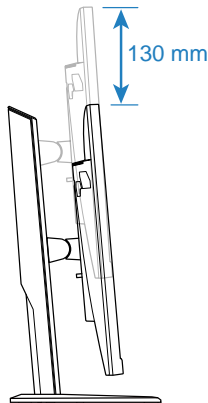

Installing a Wall-Mount Bracket (Optional)

Use only a 100 x 100 mm VESA compatible wall mount kit.

1. Place the monitor on the lower EPS foam, with the screen facing down.
2. Push the release button upwards to disengage the stand from the monitor.

Then remove the stand.

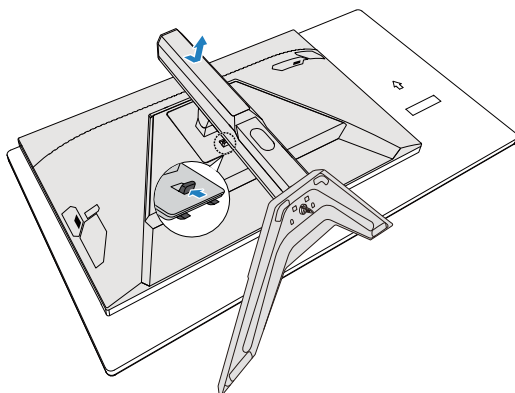

3. Attach the mounting bracket to the mounting holes at the rear of the monitor. Then use the screws to secure the bracket in place.

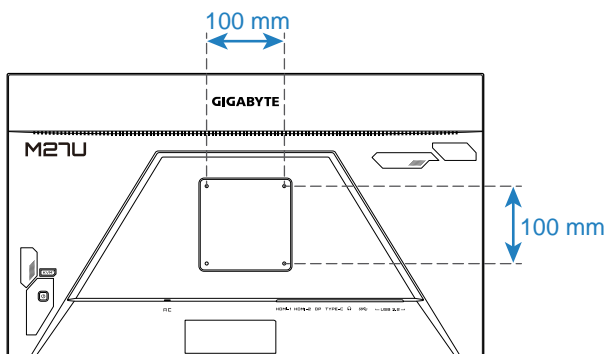

Note: To mount the monitor on the wall, refer to the installation guide that is included in the wall-mount bracket kit. VESA mounting screw size: M4 x 20mm minimum.

Making Connections

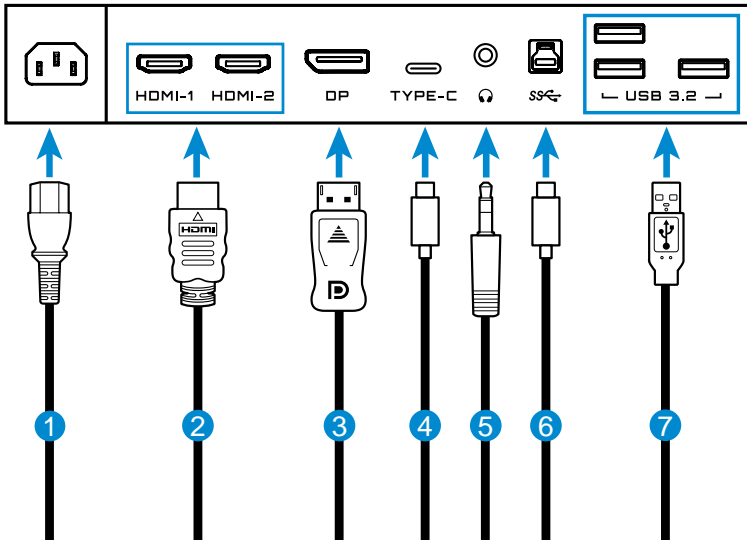

- 1 Power cable
- 2 HDMI cable
- 3 DisplayPort cable
- 4 USB Type-C cable
- 5 Headphone cable
- 6 USB (A-Male to B-Male) cable
- 7 USB cable

USING THE DEVICE

Turning the Power On/Off

Power On

1. Connect one end of the power cable to the AC IN jack at the rear of the monitor.
2. Connect other end of the the power cable to a power outlet.
3. Press the Control button to turn on the monitor. The Power LED will light in white, indicating the monitor is ready to use.

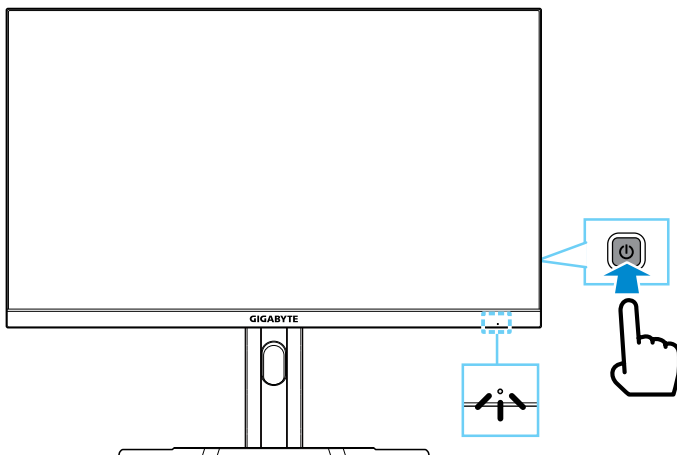

Note: If no signal, the monitor will show **No Signal** notification for a while. Then, the monitor will go to power saving mode and the Power LED lights white and starts blinking with a period of one second.

Power Off

Press the **Control** button for 2 seconds to turn off the monitor.



Note: When the **Main** menu appears on the screen, you can also turn off the monitor by moving the **Control** button down (⬇️). Refer to page 19.

User Comfort Recommendations

The monitor adopts Flicker-Free technology which clears the eye visible monitor flicker and prevents users from suffering eye strain and fatigue. The following are some tips for comfortable viewing of your monitor:

- Optimal viewing distances for monitors range from approximately 510 mm to 760 mm (20" to 30").
- A general guideline is to position the monitor such that the top of the screen is at or slightly below your eye-height when you are comfortably seated.
- Use adequate lighting for the type of work you are performing.
- Take regular and frequent breaks (at least for 10 minutes) every half-hour.
- Be sure to periodically look away from your monitor screen and focus on a far object for at least 20 seconds during the breaks.
- Eye exercise can help reduce eye strain. Repeat these exercises frequently: (1) look up and down (2) slowly roll your eye (3) move your eyes diagonally.

Selecting the Input Source

1. Move the **Control** button right () to enter the **Input** menu.
2. Move the **Control** button up/down () to select the desired input source. Then press the **Control** button to confirm.

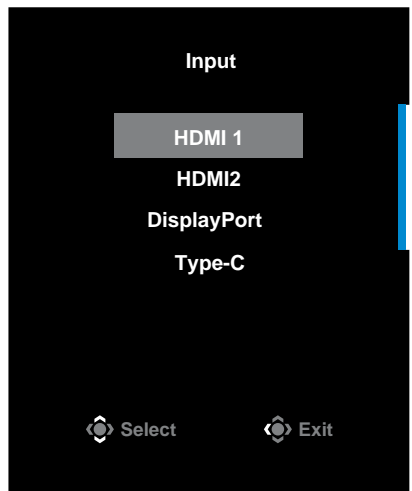

OPERATIONS

Quick Menu

Hot Key

By default, the **Control** button has been assigned with the specific function.

Note: To change the preset hot key function, refer to the “**Quick Switch**” section on page 34.

To access the hot key function, do the following:

- Move the **Control** button up () to enter the **Black Equalizer** menu.

Move the **Control** button up/down () to adjust Black Equalizer the setting and press the **Control** button to confirm.

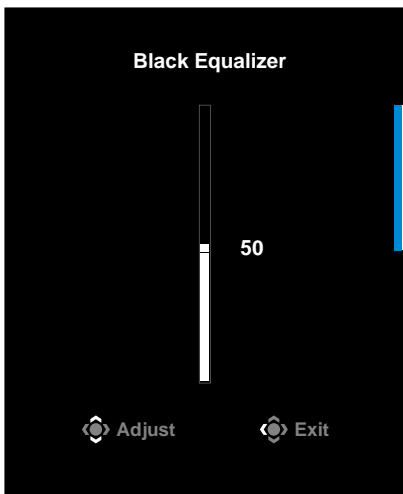

- Move the **Control** button down () to enter the **Picture Mode** menu.

Move the **Control** button up/down () to select the desired option and press the **Control** button to confirm.

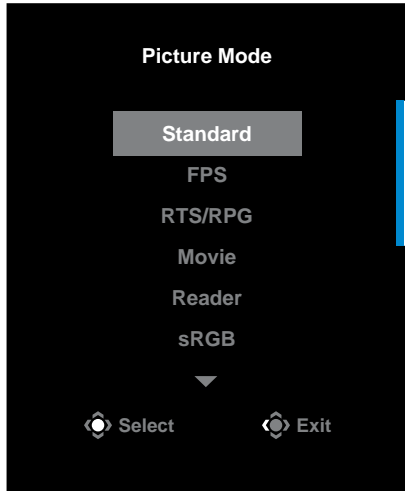

- Move the **Control** button left () to enter the **Volume** menu.

Move the **Control** button up/down () to adjust the headphone volume level and press the **Control** button to confirm.

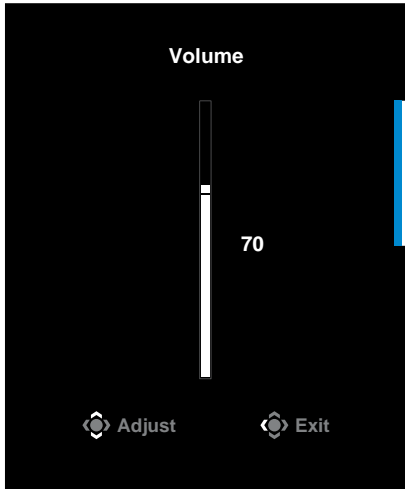

- Move the **Control** button left () to enter the the **Input** menu. Refer to the “**Selecting the Input Source**” section.

Note: To close the menu, move the **Control** button left ().

Function Key Guide

Press the **Control** button to display the **Main** menu.

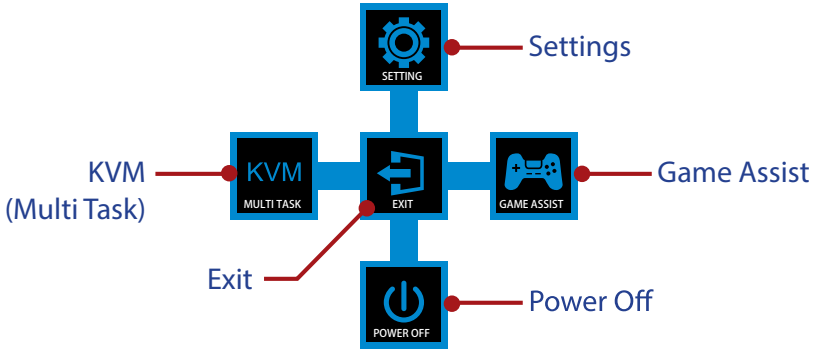

Then use the **Control** button to select the desired function and configure the related settings.

KVM

When the **Main** menu appears on the screen, move the **Control** button left () to enter the **KVM** menu.

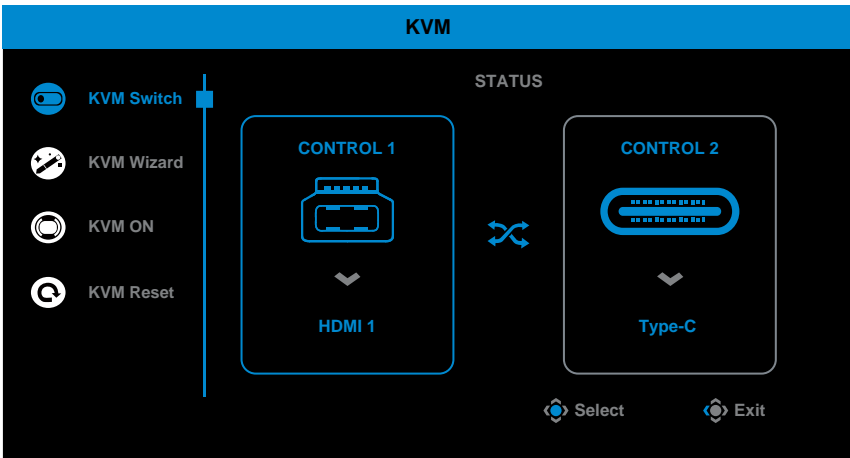

- **KVM Switch:** Switch the input source that has been assigned to USB-B or Type-C connection in the **KVM Wizard** settings. When there are several input signals connected to the device, a message box will appear on the screen once the system detected USB Type-C input signal.



To switch to USB Type-C input source, simply press the KVM button or the **Control** button.

However, when there is no input signal from currently selected input source, the system will return to the previous connected input source.

Note: This option will be disabled if the KVM button function is disabled (**KVM OFF**).

- **KVM Wizard:** Configure the KVM related settings. Set the input source to be bound with USB Type-B connection first, and then following with USB Type-C connection.

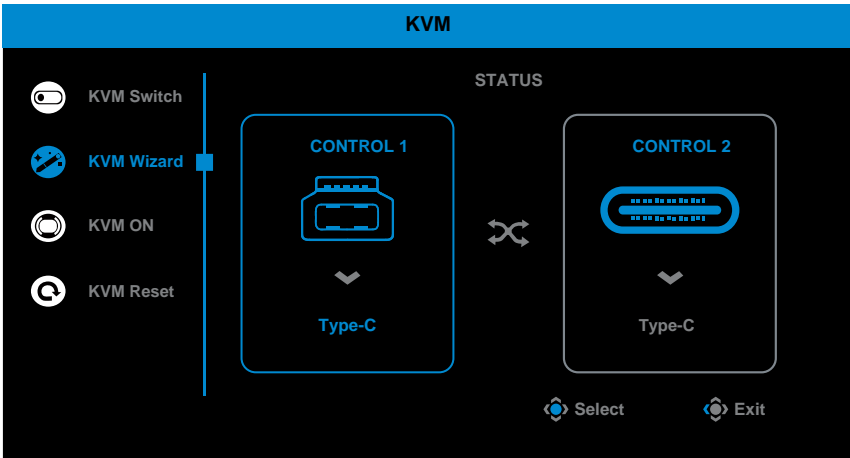

Note: If you set the **USB-B Display** setting to **Type-C**, the **TYPE-C Display** menu option will automatically be disabled. You will then see the **KVM status** in the **KVM Wizard** page as below.

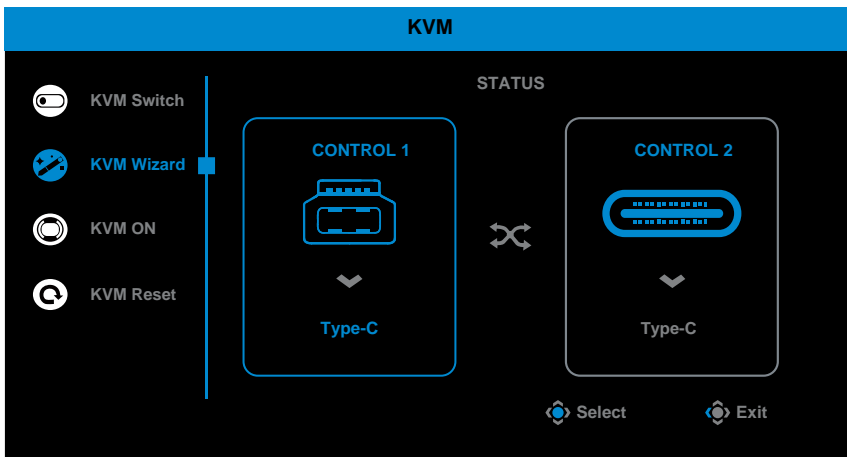

- **KVM ON/OFF:** Enable/Disable the **KVM** button function.
 - ✓ Select **ON** to enable the **KVM** button function. Once the system detected USB Type-C input signal, a message box will appear on the screen.



Press the **KVM** button or the **Control** button to switch to USB Type-C input source.

Note: When the **KVM** button function is enabled, the **KVM ON** will be displayed on the left panel.

- ✓ Select **OFF** to disable the **KVM** button function.
 - Note:** When the **KVM** button function is disabled, the **KVM OFF** will be displayed on the left panel.
- **KVM Reset:** Restore the KVM default settings.
 - ✓ HDMI 1 input source is bound with USB Type-B connection.
 - ✓ USB Type-C input source is bound with USB Type-C connection.
 - ✓ The **KVM ON/OFF** function is set to **ON**.

Game Assist

When the **Main** menu appears on the screen, move the **Control** button right () to enter the **Game Assist** menu.

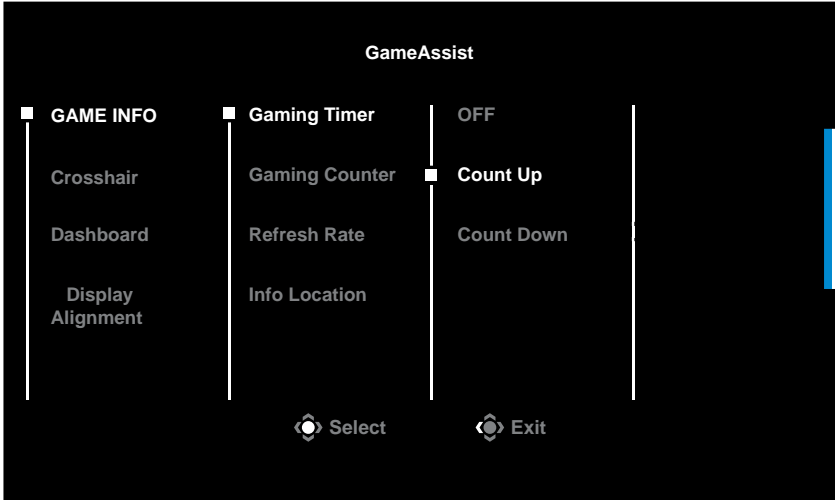

- **GAME INFO:** Configure the FPS (First Person Shooting) game related settings.
 - ✓ Select **Gaming Timer** to select countdown timer mode. To disable this function, set the setting to **OFF**.
 - ✓ Select **Gaming Counter** or **Refresh Rate** to enable/disable the gaming counter or real-time refresh rate setting.
 - ✓ Select **Info Location** to specify the location of the information to be shown on the screen.



- **Crosshair:** Select the desired crosshair type to suit your gaming environment. It makes aiming much easier.

- **Dashboard:** Configure the dashboard settings.

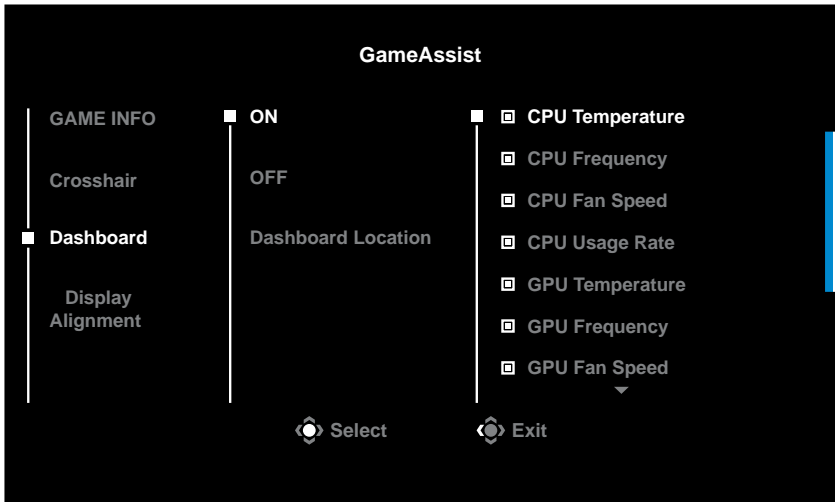

- ✓ **ON:** Enable the function. Then select the desired option(s) to be shown on the screen.
- ✓ **OFF:** Disable the function.
- ✓ **Dashboard Location:** Specify the location of the Dashboard information to be shown on the screen. Once the Dashboard configuration is complete, it will transfer the system data to the SOC through the USB port and display the value of the selected function(s) on the screen.

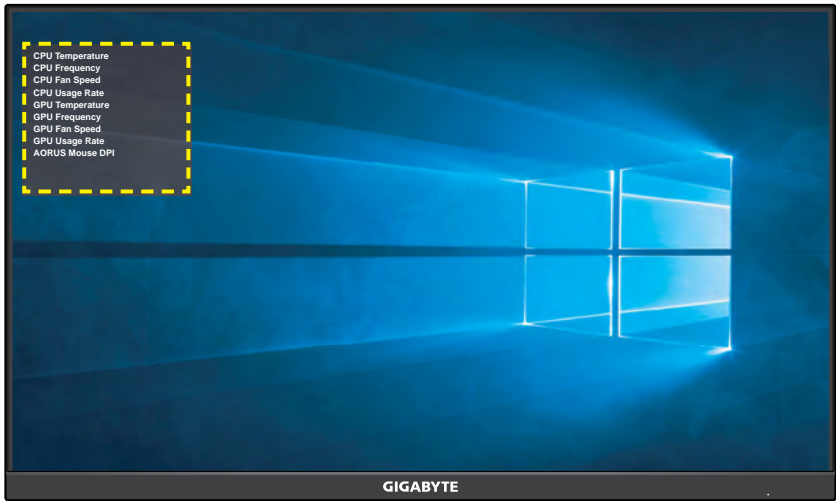

Note: Make sure the USB cable is properly connected to the USB upstream port of the monitor and the USB port of your computer.

- **Display Alignment:** When the function is enabled, it displays the alignment lines on the four sides of the screen, providing handy tool for you to line up multiple monitors perfectly.

Configure the Device Settings

When the **Main** menu appears on the screen, move the **Control** button up () to enter the **Settings** menu.

Note: Use the **Control** button to navigate through the menu and make adjustments.

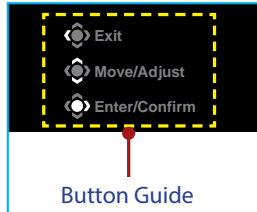

Gaming

Configure the game related settings.

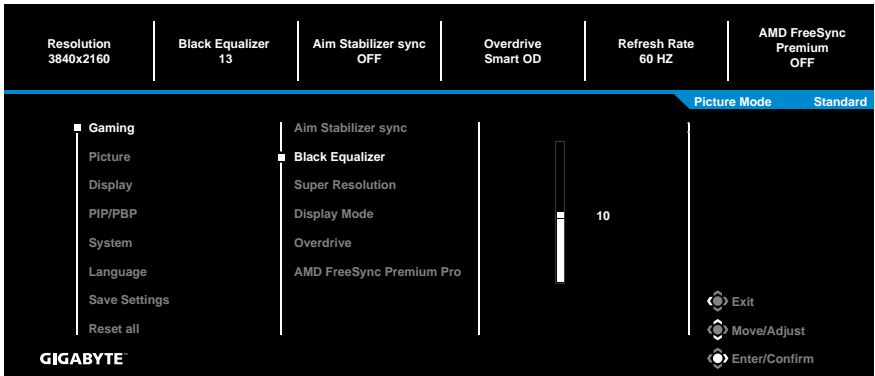

Item	Description
Aim Stabilizer sync	When this function is enabled, it reduces the motion blur in a fast moving games. Note: This function is not available under the following conditions: - when the frequency setting is lower than 100Hz. - when the current source is HDR.
Black Equalizer	Adjust the brightness of the black areas.

Super Resolution	Sharpen the low resolution images.
Display Mode	<p>Select the aspect ratio of the screen.</p> <ul style="list-style-type: none">• Full: Scale the input image to fill the screen. Ideal for 16:9 aspect images.• Aspect: Display the input image without geometric distortion filling as much of the screen as possible.• 1:1: Display the input image in its native resolution without scaling.• 22"W(16:10): Display the input image as if on a 22"W monitor of 16:10 aspect ratio.• 23"W(16:9): Display the input image as if on a 23"W monitor of 16:9 aspect ratio.• 23.6"W(16:9): Display the input image as if on a 23.6"W monitor of 16:9 aspect ratio.• 24"W(16:9): Display the input image as if on a 24"W monitor of 16:9 aspect ratio. <p>Note: 1:1, 22"W(16:10), 23"W(16:9), 23.6"W(16:9), and 24"W(16:9) options will be disabled when the AMD FreeSync Premium function is activated.</p>
Overdrive	Improve the response time of the LCD monitor.
AMD FreeSync Premium Pro	When this function is enabled, it eliminates the screen lag and tearing while playing games.

Picture

Configure the image related settings.

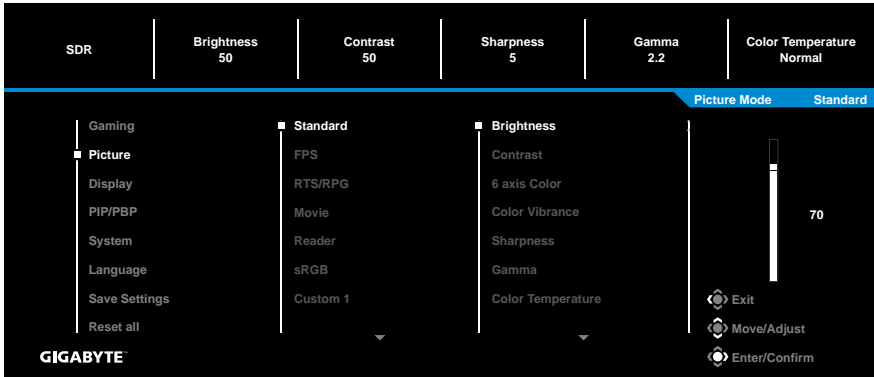

Select the one of the preset picture mode.

- Standard: For editing documents or browsing websites.
- FPS: For playing FPS (First Person Shooting) games.
- RTS/RPG: For playing RTS (Real-Time Strategy) or RPG (Role-Playing Game) games.
- Movie: For watching movies.
- Reader: For viewing documents.
- sRGB: For viewing photos and graphics on the computer.
- Custom 1: Customized picture mode settings.
- Custom 2: Customized picture mode settings.
- Custom 3: Customized picture mode settings.

Then you can configure the following image settings.

Item	Description
Brightness	Adjust the brightness of the image.
Contrast	Adjust the contrast of the image.
6-axis Color	An advanced color adjustment that user can individually customize hue and saturation for each axis color.
Color Vibrance	Adjust the intensity of the more muted colors.
Sharpness	Adjust the sharpness of the image.
Gamma	Adjust the middle level of luminance.

Color Temperature	Select the color temperature. Note: Select User Define to customize the color temperature by adjusting the red (R), green (G), or blue (B) level according to your preference.
Low Blue Light	Reduce the amount of blue light exposure from the screen. <ul style="list-style-type: none"> Level 0: No change. Level 1~10: The higher the level, the more blue light will be reduced. Note: Level 10 is optimized setting. It is compliance with TUV Low Blue Light Certification.
DCR	Adjust the black level of the image to achieve the optimum contrast.
Local Dimming	Improve the blackness of images displayed on the monitor.
Reset Picture	Reset all Picture settings to the default settings.

Note: The following picture modes will be shown only when the input source has HDR content.



- Dark Enhance: Enhance the Darkness performance.
- Color Enhance: Enhance the Color performance.
- Light Enhance: Enhance the Brightness performance.
- Local Dimming: Select the dimming level to improve the contrast.

Display

Configure the display screen related settings.

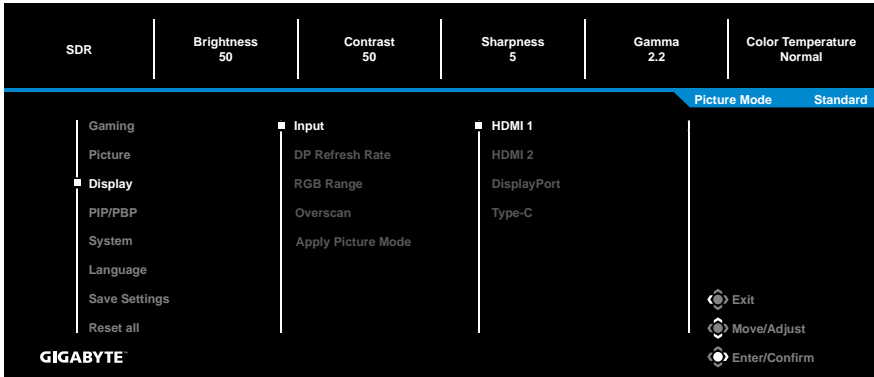

Item	Description
Input	Select the input source.
DP Refresh Rate	Switch the Refresh Rate of DisplayPort to higher timing.
RGB Range	Select an appropriate RGB range setting or let the monitor to detect it automatically. Note: This option is only available for HDMI input.
Overscan	When this function is enabled, it slightly enlarges the input image to hide the outermost edges of the image. Note: This option is only available for HDMI input.
Apply Picture Mode	When this function is selected, if change any one of the settings related Picture options such as Brightness, Contrast etc., could be applied to all of Input sources or specific one.

PIP/PBP

Configure the multi-picture related settings.

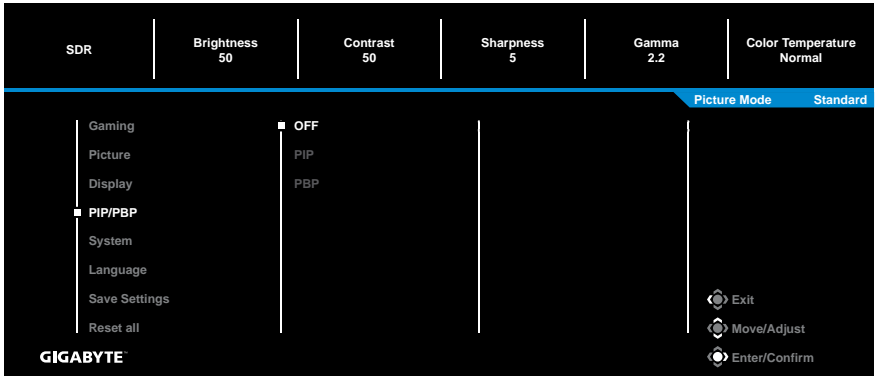

Item	Description
OFF	Disable the PIP/PBP function.
PIP	<p>Split the screen into 2 parts (main window and inset window).</p> <ul style="list-style-type: none"> • Source: Change the input source for the inset window. • PIP Size: Adjust the inset window size. • Location: Move the inset window position. • Display Switch: Swap the two windows. • Audio Switch: Select which audio source you want to hear the sound from. <p>Note: PIP would only support when vertical frequency is over 100Hz.</p>
PBP	<p>Display 1x1 split screen (left and right windows).</p> <ul style="list-style-type: none"> • Source: Change the input source for the right window. • PBP Mode: Adjust the aspect ratio of window. • Display Switch: Swap the two windows. • Audio Switch: Select which audio source you want to hear the sound from.



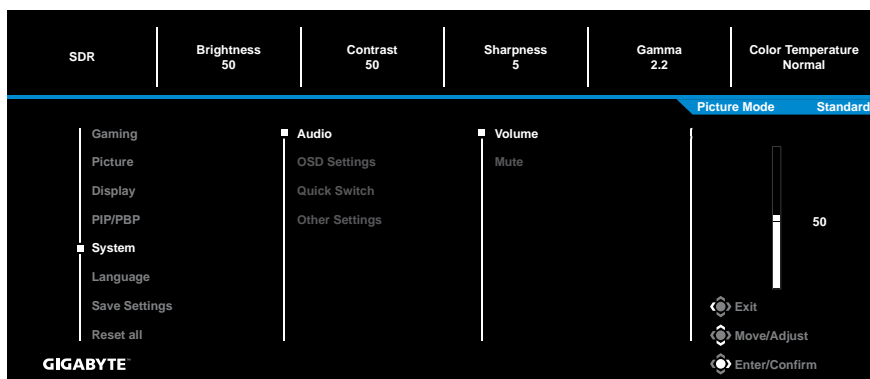

Note: PIP/PBP is not compatible with HDR and AMD FreeSync Premium functions.

System

Configure the system related settings.



Item	Description
Audio	<p>Configure the audio settings.</p> <ul style="list-style-type: none"> Volume: Adjust the volume level. Mute: Enable/Disable the mute function.
OSD Settings	<p>Configure the on-screen display (OSD) menu related settings.</p> <ul style="list-style-type: none"> Display Time: Set the length of time the OSD menu remains on the screen. OSD Transparency: Adjust the OSD menu transparency. OSD Lock: When this function is enabled, no OSD adjustment is allowed. <p>Note: To disable the OSD lock function, press the Control key. When the message appears on the screen, select Yes to confirm.</p> <div data-bbox="514 1182 783 1310" style="background-color: black; color: white; padding: 5px; text-align: center;"> <p>The button is locked confirm to unlock OSD</p> <p>No Yes</p> </div> OSD Size: Enable or disable adjusting the OSD menu window. OSD Pivot: Set the OSD menu orientation.

<p>Quick Switch</p>	<p>Assign the function of the hot keys.</p> <p>Available options: Aim Stabilizer sync, Black Equalizer, Low Blue Light, Volume, Input, Contrast, Brightness, and Picture Mode.</p> <p>The default setting of the hot keys as below:</p> <p>⇒ Up (): Black Equalizer</p> <p>⇒ Down (): Picture Mode</p> <p>⇒ Right (): Input</p> <p>⇒ Left (): Volume</p>
<p>Other Settings</p>	<ul style="list-style-type: none"> • Resolution Notice: When this function is enabled, the recommended resolution message will appear on the screen when the monitor switches to another input source. • Input Auto Switch: When this function is enabled, it automatically switches to an available input source. • Auto Power OFF: When this function is enabled, the monitor will automatically turn off after a certain amount of time. • LED Indicator: By default, the LED indicator is set to Always ON. <ul style="list-style-type: none"> ⇒ Always ON: The Power LED lights white during operation in standby mode. ⇒ Always OFF: Turn off the Power LED. ⇒ Standby ON: The Power LED lights white in standby mode. ⇒ When the power supply is switched off, the Power LED will remain off. • Type-C Compatibility: Turn this option on to improve mobile devices compatibility. • HDMI Version: Select the HDMI version.

Other Settings (continue)

- **HDMI-CEC:** When enable this function, CEC device like PS5, XBOX could turn on the monitor when they are waken up and switch off the display when they enter either Standby or off mode.
- **USB(A/C) Charge:** Enable or disable the USB Type-A charging and USB Type-C charging(5V/3A, 9V/3A,12V/3A,15V/3A) function in standby mode.

Language

Select an available language for the OSD menu.

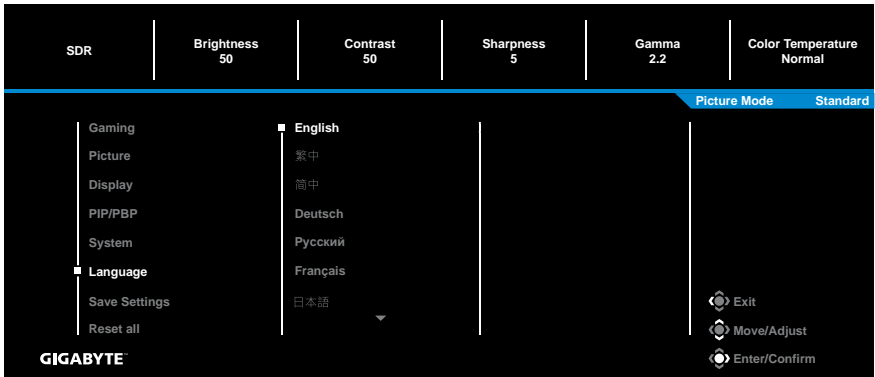

Save Settings

Set the personalized OSD configurations for Setting1, Setting2, or Setting3.



Item	Description
Save	Save the customized settings.
Load	Load the saved settings

Reset all

Restore the monitor to its factory default settings.

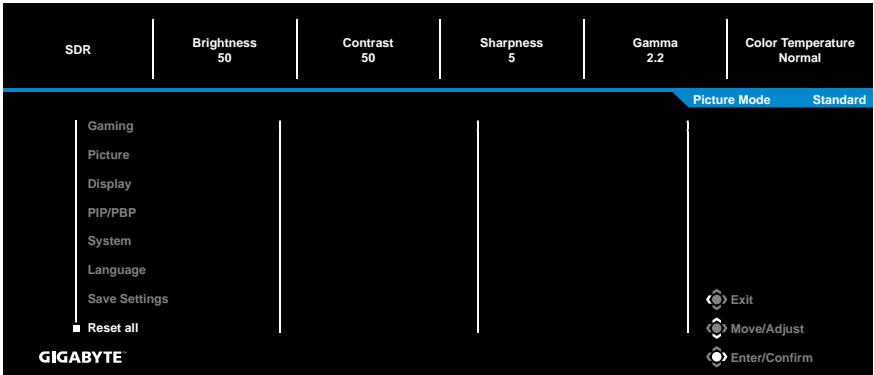

APPENDICES

Specifications

Item	Specifications
Panel Size	27-inch
Aspect Ratio	16:9
Resolution	3840 x 2160
LED Life	30,000 hours
Pixel Pitch	155.25 x 155.25
Brightness	400nits (typ.)
Contrast Ratio	1000:1 (typ.)
Display colors	1.07 Billion colors (8bit + FRC)
Active Display Area	596.16 (H) x 335.34 (V)
Viewing Angle	178°(H) / 178°(V)
Input/Output Terminals	<ul style="list-style-type: none"> • 2x HDMI 2.1 • 1x DP1.4 • 1x Headphone • 1x USB upstream • 3x USB 3.2 (downstream, 5V/1.5A) • 1x USB Type-C(5V/3A,9V/2A,12V/1.5A, 15V/1.2A)
Power Supply	AC 100~240V at 50/60Hz
Power Consumptions	<ul style="list-style-type: none"> • On Mode: 30W • Standby: 0.5W • Off: 0.3W <p>Note:The test condition follows CEC standards.</p>
Dimensions (W x H x D)	615.67x517.65x193.63mm(with stand)
Weight	<ul style="list-style-type: none"> • 6.48 kg (with stand) • 4.56 kg (without stand)
Temperature Range (operation)	0°C to 40°C

Note: Specifications subject to change without notice.

Supported Timing List

Timing List	HDMI	DP(Type-C)
720X400 / 70Hz	V	V
720X400 / 88Hz	V	V
640X480 / 60Hz	V	V
640X480 / 67Hz	V	V
640X480 / 72Hz	V	V
640X480 / 75Hz	V	V
800X600 / 56Hz	V	V
800X600 / 60Hz	V	V
800X600 / 72Hz	V	V
800X600 / 75Hz	V	V
832X624 / 75Hz	V	V
1024X768 / 87Hz	V	V
1024X768 / 60Hz	V	V
1024X768 / 70Hz	V	V
1024X768 / 75Hz	V	V
1280X1024 / 75Hz	V	V
1152X870 / 75Hz	V	V
1152X864 / 75Hz	V	V
1280X720 / 60Hz	V	V
1280X800 / 60Hz	V	V
1280X960 / 60Hz	V	V
1280X1024 / 60Hz	V	V
1440X900 / 60Hz	V	V
1600X900 / 60Hz	V	V
1680X1050 / 60Hz	V	V

Timing List	HDMI	DP(Type-C)
720X480 / 60Hz	V	V
1280X720 / 50hz	V	V
1280X720 / 60hz	V	V
1280X720 / 100hz	V	V
1440X480 / 60hz	V	V
1920X1080 / 24Hz	V	X
1920X1080 / 50hz	V	V
1920X1080 / 60hz	V	V
1920X1080 / 100hz	V	V
1920X1080 / 120Hz	V	V
3840X2160 / 24Hz	V	X
3840X2160 / 25Hz	V	X
3840X2160 / 30Hz	V	X
3840X2160 / 50Hz	V	V
3840X2160 / 60Hz	V	V
3840X2160 / 100Hz	V	V
3840X2160 / 120Hz	V	V
1920x1080 / 144Hz	V	V
2560x1440 / 60Hz	V	V
2560x1440 / 120Hz	V	V
2560x1440 / 144Hz	V	V
3840x2160 / 144Hz	V	V
3840x2160 / 150Hz	V	V
3840x2160 / 160Hz(Optional)	X	V
1280x1440 / 60Hz(PBP)	V	V
1920x2160 / 60Hz(PBP)	V	V

Troubleshooting

Problem	Possible Solution(s)
No power	<ul style="list-style-type: none"> • Make sure the power cable is properly connected to the power source and the monitor. • Check the cable and plug to make sure they are not broken. • Make sure the monitor is turned on.
No image appears on the screen	<ul style="list-style-type: none"> • Make sure the monitor and the computer are properly connected and both devices are turned on. • Make sure you have selected the correct input source. Refer to page 17 or 31. • Adjust the Brightness and Contrast settings. Refer to page 29.
The image does not fill the entire screen	<ul style="list-style-type: none"> • Try different Display Mode (aspect ratio) setting. Refer to page 28.
The colors are distorted	<ul style="list-style-type: none"> • Make sure the input signal cable is properly connected. • Configure the image related settings. Refer to the "Picture" section.
No sound or volume is low	<ul style="list-style-type: none"> • Make sure the headphone cable is properly connected. • Adjust the volume level. Refer to page 19 or 33. • Adjust your computer sound related settings.

Note: If the problem persists, please contact our customer service for further assistance.

Basic Care

When the screen becomes dirty, do the following to clean the screen:

- Wipe the screen with your soft, lint-free cloth to remove any residual dust.
- Spray or apply the cleaning fluid onto a soft cloth. Then wipe the screen gently with the damp cloth.

Note:

- Make sure that the cloth is damp, but not wet.
- When wiping, avoid applying excessive pressure on the screen.
- Acidic or abrasive cleaners can damage the screen.

GIGABYTE Service Information

More service information, please visit GIGABYTE official website:

<https://www.gigabyte.com/>



FLICKER-FREE

Without causing eye strain and other injuries.

General Description

M27U is a color active matrix liquid crystal display with a Light Emitting Diode (LED) backlight assembly without LED driver. The matrix employs a-Si thin film transistor as the active element. It is a transmissive type display operating in the normally black mode. It has a 27 inch diagonally measured active display area with UHD resolution(3840 horizontal by 2160 vertical pixel array) Each pixel is divided into red, green and blue sub-pixels or dots which are arranged in vertical stripes. Gray scale or the brightness of the sub-pixel color is determined with a 8bit+ FRC gray scale signal for each dot, thus, presenting a palette of more than 1.07 Billion colors. It has been designed to apply eDP (HBR2, 5.4Gbps) interface. It is intended to support displays where high brightness, super wide viewing angle, high color saturation, and high color are important.

SAFETY INFORMATION

Regulatory Notices

United States of America, Federal Communications Commission Statement

Supplier's Declaration of Conformity 47 CFR § 2.1077 Compliance Information

Product Name: **LCD monitor**

Trade Name: **GIGABYTE**

Model Number: **M27U**

Responsible Party – U.S. Contact Information: **G.B.T.Inc.**

Address: 17358 Railroad street, City Of Industry, CA91748

Tel.: 1-626-854-9338

Internet contact information: <https://www.gigabyte.com>

FCC Compliance Statement:

This device complies with Part 15 of the FCC Rules, Subpart B, Unintentional Radiators.

Operation is subject to the following two conditions: (1) This device may not cause harmful interference, and (2) this device must accept any interference received, including interference that may cause undesired operation.

This equipment has been tested and found to comply with the limits for a Class B digital device, pursuant to Part 15 of the FCC Rules. These limits are designed to provide reasonable protection against harmful interference in a residential installation. This equipment generates, uses and can radiate radio frequency energy and, if not installed and used in accordance with manufacturer's instructions, may cause harmful interference to radio communications. However, there is no guarantee that interference will not occur in a particular installation. If this equipment does cause harmful interference to radio or television reception, which can be determined by turning the equipment off and on, the user is encouraged to try to correct the interference by one or more of the following measures:

- Reorient or relocate the receiving antenna.
- Increase the separation between the equipment and receiver.

- Connect the equipment to an outlet on a circuit different from that to which the receiver is connected.
- Consult the dealer or an experienced radio/TV technician for help.

Canadian Department of Communications Statement

This digital apparatus does not exceed the Class B limits for radio noise emissions from digital apparatus set out in the Radio Interference Regulations of the Canadian Department of Communications. This class B digital apparatus complies with Canadian ICES-003.

Avis de conformité à la réglementation d'Industrie Canada

Cet appareil numérique de la classe B est conforme à la norme NMB-003 du Canada.

European Union (EU) CE Declaration of Conformity

This device complies with the following directives: Electromagnetic Compatibility Directive 2014/30/EU, Low-voltage Directive 2014/35/EU, ErP Directive 2009/125/EC, RoHS directive (recast) 2011/65/EU & the 2015/863 Statement.

This product has been tested and found to comply with all essential requirements of the Directives.

European Union (EU) RoHS (recast) Directive 2011/65/EU & the European Commission Delegated Directive (EU) 2015/863 Statement

GIGABYTE products have not intended to add and safe from hazardous substances (Cd, Pb, Hg, Cr+6, PBDE, PBB, DEHP, BBP, DBP and DIBP). The parts and components have been carefully selected to meet RoHS requirement. Moreover, we at GIGABYTE are continuing our efforts to develop products that do not use internationally banned toxic chemicals.

European Union (EU) Community Waste Electrical & Electronic Equipment (WEEE) Directive Statement

GIGABYTE will fulfill the national laws as interpreted from the 2012/19/EU WEEE (Waste Electrical and Electronic Equipment) (recast) directive. The WEEE Directive specifies the treatment, collection, recycling and disposal of electric and electronic devices and their components. Under the Directive, used equipment must be marked, collected separately, and disposed of properly.

WEEE Symbol Statement

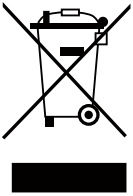

The symbol shown below is on the product or on its packaging, which indicates that this product must not be disposed of with other waste. Instead, the device should be taken to the waste collection centers for activation of the treatment, collection, recycling and disposal procedure.

For more information about where you can drop off your waste equipment for recycling, please contact your local government office, your household waste disposal service or where you purchased the product for details of environmentally safe recycling.

End of Life Directives-Recycling



The symbol shown below is on the product or on its packaging, which indicates that this product must not be disposed of with other waste. Instead, the device should be taken to the waste collection centers for activation of the treatment, collection, recycling and disposal procedure.

Déclaration de Conformité aux Directives de l'Union européenne (UE)

Cet appareil portant la marque CE est conforme aux directives de l'UE suivantes: directive Compatibilité Electromagnétique 2014/30/UE, directive Basse Tension 2014/35/UE, directive 2009/125/CE en matière d'écoconception, la directive RoHS II 2011/65/UE & la déclaration 2015/863.

La conformité à ces directives est évaluée sur la base des normes européennes harmonisées applicables.

European Union (EU) CE-Konformitätserklärung

Dieses Produkte mit CE-Kennzeichnung erfüllen folgenden EU- Richtlinien: EMV-Richtlinie 2014/30/EU, Niederspannungsrichtlinie 2014/30/EU, Ökodesign-Richtlinie 2009/125/EC, RoHS-Richtlinie 2011/65/ EU erfüllt und die 2015/863 Erklärung.

Die Konformität mit diesen Richtlinien wird unter Verwendung der entsprechenden Standards zur Europäischen Normierung beurteilt.

CE declaração de conformidade

Este produto com a marcação CE estão em conformidade com das seguintes Diretivas UE: Diretiva Baixa Tensão 2014/35/EU; Diretiva CEM 2014/30/EU; Diretiva Conceção Ecológica 2009/125/CE; Diretiva RSP 2011/65/UE e a declaração 2015/863.

A conformidade com estas diretivas é verificada utilizando as normas europeias harmonizadas.

CE Declaración de conformidad

Este producto que llevan la marca CE cumplen con las siguientes Directivas de la Unión Europea: Directiva EMC 2014/30/EU, Directiva de bajo voltaje 2014/35/EU, Directiva de Ecodiseño 2009/125/EC, Directiva RoHS 2011/65/EU y la Declaración 2015/863.

El cumplimiento de estas directivas se evalúa mediante las normas europeas armonizadas.

CE Dichiarazione di conformità

I prodotti con il marchio CE sono conformi con una o più delle seguenti Direttive UE, come applicabile: Direttiva EMC 2014/30/UE, Direttiva sulla bassa tensione 2014/35/UE, Direttiva Ecodesign EMC 2009/125/EC, Direttiva RoHS 2011/65/EU e Dichiarazione 2015/863.

La conformità con tali direttive viene valutata utilizzando gli Standard europei armonizzati applicabili.

Deklaracja zgodności UE Unii Europejskiej

Urządzenie jest zgodne z następującymi dyrektywami: Dyrektywa kompatybilności elektromagnetycznej 2014/30/UE, Dyrektywa niskonapięciowej 2014/35/UE, Dyrektywa ErP 2009/125/WE, Dyrektywa RoHS 2011/65/UE i dyrektywa 2015/863.

Niniejsze urządzenie zostało poddane testom i stwierdzono jego zgodność z wymaganiami dyrektywy.

ES Prohlášení o shodě

Toto zařízení splňuje požadavky Směrnice o Elektromagnetické kompatibilitě 2014/30/EU, Směrnice o Nízkém napětí 2014/35/EU, Směrnice ErP 2009/125/ES, Směrnice RoHS 2011/65/EU a 2015/863.

Tento produkt byl testován a bylo shledáno, že splňuje všechny základní požadavky směrnic.

EK megfelel ségi nyilatkozata

A termék megfelelnek az alábbi irányelvek és szabványok követelményeinek, azok a kiállításidőpontjában érvényes, aktuális változatában: EMC irányelv 2014/30/EU, Kíszfeszültségű villamos berendezésekre vonatkozó irányelv 2014/35/EU, Környezetbarát tervezésről szóló irányelv 2009/125/EK, RoHS irányelv 2011/65/EU és 2015/863.

Δήλωση συμμόρφωσης ΕΕ

Είναι σε συμμόρφωση με τις διατάξεις των παρακάτω Οδηγιών της Ευρωπαϊκής Κοινότητας: Οδηγία 2014/30/ΕΕ σχετικά με την ηλεκτρομαγνητική συμβατότητα, Οδηγία χαμηλής τάση 2014/35/ΕU, Οδηγία 2009/125/ΕΚ σχετικά με τον οικολογικό σχεδιασμό, Οδηγία RoHS 2011/65/ΕΕ και 2015/863.

Η συμμόρφωση με αυτές τις οδηγίες αξιολογείται χρησιμοποιώντας τα ισχύοντα εναρμονισμένα ευρωπαϊκά πρότυπα.

Japan Class 01 Equipment Statement

安全にご使用いただくために

接地接続は必ず電源プラグを電源につなぐ前に行ってください。

また、接地接続を外す場合は、必ず電源プラグを電源から切り離してから行って下さい。

Japan VCCI Class B Statement

クラスB VCCI 基準について

この装置は、クラスB情報技術装置です。この装置は、家庭環境で使用することを目的としていますが、この装置がラジオやテレビジョン受信機に近接して使用されると、受信障害を引き起こすことがあります。

取扱説明書に従って正しい取り扱いをして下さい。

VCCI-B

China RoHS Compliance Statement

中国《废弃电器电子产品回收处理管理条例》提示性说明

为了更好地关爱及保护地球，当用户不再需要此产品或产品寿命终止时，请遵守国家废弃电器电子产品回收处理相关法律法规，将其交给当地具有国家认可的回收处理资质的厂商进行回收处理。

环保使用期限

Environment-friendly use period



此标识指期限（十年），电子电气产品中含有的有害物质在正常使用的条件下不会发生外泄或突变，电子电气产品用户使用该电子电气产品不会对环境造成严重污染或对其人身、财产造成严重损害的期限。

产品中有害物质名称及含量：

部件名称	有害物质					
	铅 (Pb)	汞 (Hg)	镉 (Cd)	六价铬 (Cr+6)	多溴联苯 (PBB)	多溴二苯醚 (PBDE)
印刷电路板及其电子组件	X	○	○	○	○	○
液晶面板	X	○	○	○	○	○
外壳	○	○	○	○	○	○
外部信号连接头及线材	X	○	○	○	○	○

本表格依据 SJ/T 11364 的规定编制。

This table is prepared in compliance with the requirements of SJ/T 11364

○：表示该有害物质在该部件所有均质材料中的含量均在 GB/T 26572 规定的限量要求以下。

X：表示该有害物质至少在该部件的某一均质材料中的含量超出 GB/T 26572 规定的限量要求。

限用物質含有情況標示聲明書：**Declaration of the Presence Condition of the Restricted Substances Marking**

設備名稱：液晶顯示器，型號（型式）：M27U						
Equipment name		Type designation(Type)				
單元 Unit	限用物質及其化學符號 Restricted substances and its chemical symbols					
	鉛 Lead (Pb)	汞 Mercury (Hg)	鎘 Cadmium (Cd)	六价铬 Hexavalent chromium (Cr+6)	多溴联苯 Polybrominated biphenyls (PBB)	多溴二苯醚 Polybrominated diphenyls ethers (PBDE)
塑料外框	○	○	○	○	○	○
後殼	○	○	○	○	○	○
液晶面板	—	○	○	○	○	○
電路板組件	—	○	○	○	○	○
底座	○	○	○	○	○	○
電源線	—	○	○	○	○	○
其他線材	—	○	○	○	○	○

備考1. “超出0.1 wt%”及“超出0.01 wt%”係指限用物質之百分比含量超出百分比含量基準值。

Note 1: "Exceeding 0.1 wt%" and "exceeding 0.01 wt%" indicate that the percentage content of the restricted substance exceeds the reference percentage value of presence condition.

備考2. "○"係指該項限用物質之百分比含量未超出百分比含量基準值。

Note 2: "○" indicates that the percentage content of the restricted substance does not exceed the percentage of reference value of presence.

備考3. "—"係指該項限用物質為排除項目。

Note 3: The "—" indicates that the restricted substance corresponds to the exemption.