













Safety and Regulatory Information

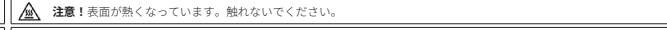

Sicherheit und gesetzliche Bestimmungen / Informations sur la sécurité et la réglementation / Informação sobre normativa y de seguridad / Informações de segurança e regulamentares / Informazioni di sicurezza e sui regolamenti / Соответствие требованиям безопасности / Informacje dotyczące bezpieczeństwa i przepisów / Güvenlik ve Düzeneleyici Bilgi / 安全與規範資訊 / 安全与法规信息 / 安全および規制に関する情報 / 안전 및 규제 정보

This product must be grounded with the plug on the adapter's power cord connected to a power socket with a grounding connection.	
Risk of explosion if the battery is replaced with an incorrect type. Batteries should be recycled where possible. Disposal of used Batteries must be in accordance with local environmental regulations.	
Es besteht das Risiko einer Explosion, wenn der Akku durch einen nicht geeigneten Typ ersetzt wird. Akkus sollten nach Möglichkeit recycelt werden. Die Entsorgung gebrauchter Akkus muss in Übereinstimmung mit den örtlichen Umweltvorschriften erfolgen.	Jeśli bateria zostanie wymieniona na baterię niewłaściwego typu istnieje ryzyko wybuchu. W miarę możliwości baterie należy poddawać recyklingowi. Utylizacja zużytych baterii musi być zgodna z lokalnymi przepisami dotyczącymi ochrony środowiska.
Risque d'explosion si la batterie est remplacée par un type incorrect. Dans la mesure du possible, les batteries doivent être recyclées. L'élimination des batteries usagées doit être conforme à la réglementation environnementale locale.	Pil yanlış tipe bir pil ile değiştirilirse patlama riski ortaya çıkar. Piller, mümkünse geri dönüştürülmelidir. Kullanılmış Piller yerel çevre yasalarına uygun olarak atılmalıdır.
Existe riesgo de explosión si se sustituye la batería por una de tipo incorrecto. Las baterías deben reciclarse siempre que sea posible. La eliminación de las baterías usadas debe realizarse de acuerdo con las normas ambientales locales.	若以不正確類型的電池進行更換，可能會有爆炸的危險。應儘可能回收電池。應依照當地環保法規棄置使用過的電池。
Risco de explosão se a pilha é substituída por um tipo incorreto. As pilhas devem ser recicladas quando possível. A eliminação de pilhas usadas deve ser efetuada conforme os regulamentos ambientais locais.	
Sostituire la batteria con una di tipo non corretto può comportare rischio di esplosione. Se possibile, le batterie vanno riciclate. Lo smaltimento delle batterie usate va effettuato secondo le regole ambientali in vigore nella regione in cui ci si trova.	誤ったタイプのバッテリーに交換すると、爆発の危険があります。バッテリーは可能な限りリサイクルしてください。使用済みバッテリーの廃棄は地域の規制を遵守する必要があります。
Замена батареи на батарее ненадлежащего типа может привести к взрыву. Использованные батареи следует сдавать на переработку при наличии соответствующих возможностей. Утилизация использованных батарей должна осуществляться в соответствии с местными экологическими нормами.	Батерию не следует заменять на батарею другого типа. Использование батарей должно осуществляться в соответствии с местными экологическими нормами.
Before you open chassis to exchange an internal component, you need to power off the device and let the device cool down at least 10 minutes.	
Vor dem Öffnen des Gehäuses zum Austausch einer internen Komponente müssen Sie das Gerät ausschalten und mindestens 10 Minuten abkühlen lassen.	Przed otwarciem obudowy w celu wymiany komponentu wewnętrznego należy wyłączyć urządzenie i pozostawić je do ostygnięcia przez co najmniej 10 minut.
Avant d'ouvrir le châssis pour remplacer un composant interne, vous devez mettre l'appareil hors tension et le laisser refroidir au moins 10 minutes.	Dahill bir parçayı değiştirmek için kasayı açmadan önce cihazı kapatmanız ve en az 10 dakika soğumasını beklemeniz gerekir.
Antes de abrir el chasis para cambiar un componente interno, debe apagar el dispositivo y dejar que se enfrie durante al menos 10 minutos.	打開機殼更換內部元件前，必須先關閉裝置電源，並讓裝置降溫至少 10 分鐘。
Antes de abrir o chassis para alterar um componente interno, tem de desligar o dispositivo e deixar o dispositivo arrefecer, pelo menos, 10 minutos.	在打开机箱更换内部组件之前，需要先关闭设备电源，并让设备冷却至少 10 分钟。
Prima di aprire il telaio per cambiare un componente interno, spegnere il dispositivo e lasciarlo raffreddare per almeno 10 minuti.	内部部品を交換するためにシャーシを開ける前に、デバイスの電源をオフにして少なくとも 10 分間冷却する必要があります。
Перед открытием корпуса для замены внутренних компонентов следует выключить устройство и дать ему охладиться в течение 10 минут.	내부 구성 요소 교환을 위해 세시를 열기 전에 장치의 전원을 끄고 최소 10 분간 장치를 식혀야 합니다.
Failure to use the included Model GB-BER Power Adapter may violate regulatory compliance and may expose the user to safety hazards.	
Falls das mitgelieferte Netzteil Modell GB-BER nicht verwendet wird, kann dies gegen die gesetzlichen Vorschriften verstoßen und den Benutzer Sicherheitsrisiken aussetzen.	Niezastosowanie dołączonego modułu zasilacza GB-BER może naruszyć zgodność z przepisami i narazić użytkownika na niebezpieczeństwo.
La fait de ne pas utiliser l'adaptateur d'alimentation modèle GB-BER inclus peut constituer une violation de la conformité réglementaire et peut exposer l'utilisateur à des risques de sécurité.	GB-BER Model Güç Adaptörünün kullanılmaması yasalara uygunluğu ihlal eder ve kullanıcıyı güvenli riskine maruz bırakır.
La no utilización del adaptador de corriente modelo GB-BER incluido puede violar el cumplimiento de la normativa y puede exponer al usuario a riesgos de seguridad.	若未使用隨附的 GB-BER 型電源變壓器，可能違反規範合規性，並讓使用者暴露於危險中。
Não utilizar o adaptador de alimentação modelo GB-BER pode violar a conformidade regulamentar e pode expor o utilizador a perigos de segurança.	不使用隨附的 GB-BER 型電源适配器可能违反法规要求，且可能让用户面临危险。
Se non si usa l'adattatore per l'alimentazione modello GB-BER compreso nella confezione si rischia di violare il regolamento, e di esporre l'utente a un pericolo per la sua sicurezza.	付属のモデル GB-BER 電源アダプタをご使用にならない場合、規制違反となる場合があります。安全上の危険が生じる恐れがあります。
Неиспользование прилагаемого адаптера питания модели GB-BER является нарушением нормативных требований и может привести к возникновению опасных для пользователя ситуаций.	포함된 모델 GB-BER 전원 어댑터를 사용하지 않으면 규제 준수를 위반할 수 있으며 사용자가 안전 위험에 노출될 수 있습니다.

Package Contents

Lieferumfang / Contenu du colis / Contenido do paquete / Conteúdo da embalagem / Contenido della confezione / Комплект поставки / Zawartość opakowania / Paket içeriği / 包裝內容物 / 包装内容 / 同梱品 / 패키지 포함 물품

			
1 or 3pcs Thermal Pad (by SKU)	135W Adapter & Power Cord: 19.5Vdc, 6.92A The product should be used with the included power cord. The included power cord should not be used with other products. 製品には、同梱された電源コードセットを使用すること。同梱された電源コードセットは、他の製品に使用しないこと。	1 x VESA Mount Bracket & 6 x Screws	1 x Quick Start Guide

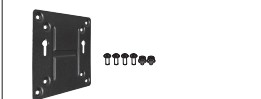
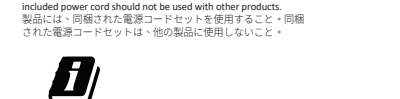
- 1 x GB-BER Bare-bone
- NOT include any of the following: M.2 (2280), 2.5" HDD, SO-DIMM memory
- Folgendes ist NICHT enthalten: M.2 (2280), 2.5" HDD, SO-DIMM Arbeitsspeicher
- N'inclut PAS les éléments suivants : M.2 (2280), disque dur 2,5", mémoire SO-DIMM
- NO incluye lo siguiente: M.2 (2280), 2.5" HDD, memoria SO-DIMM
- NÃO inclui nenhum dos seguintes: M.2 (2280), 2.5" HDD, memória SO-DIMM
- NON comprende alcuno dei seguenti componenti: Memoria M.2 (2280), HDD da 2.5", Memoria SO-DIMM
- НЕ включает: Модули памяти M.2 (2280), 2,5-дюйм накопитель, SO-DIMM модули ОЗУ
- NIE obejmuje żadnego z poniższych: M.2 (2280), 2.5 "dysk twardy, pamięć SO-DIMM
- Aşağıdakilerin hiçbirini dahil DEĞİLDİR: M.2 (2280), 2.5" HDD, SO-DIMM hafıza
- 不包含下列任何項目：M.2 (2280)、2.5" 硬碟、SO-DIMM 記憶體
- 不含以下物品：M.2 (2280)、2.5" 硬盤、SO-DIMM 內存
- 次は含まれていません：M.2 (2280)、2.5" HDD、SO-DIMM×メモリ
- 다음 물품은 포함되어 있지 않습니다: M.2(2280), 2.5" HDD, SO-DIMM 메모리

HDMI™
HIGH DEFINITION MULTIMEDIA INTERFACE



At the end of its serviceable life, this product should not be treated as household or general waste. It should be handed over to the applicable collection point for the recycling of electrical and electronic equipment, or returned to the supplier for disposal.

FCC This device complies with part 15 of the FCC Rules. Operation is subject to the following two conditions: (1) This device may not cause harmful interference, and (2) this device must accept any interference received, including interference that may cause undesired operation.



©2023 Gigacomputing Technology Co., Ltd. All rights reserved. The marks mentioned herein are trademarks or registered trademarks of GIGABYTE Technology Co., Ltd. or its affiliates. All other product names mentioned herein are trademarks or registered trademarks of their respective owners. The Adopted Trademarks HDMI, HDMI High-Definition Multimedia Interface, HDMI trade dress and the HDMI Logos are trademarks or registered trademarks of HDMI Licensing Administrator, Inc. in the United States and other countries.

GIGABYTE™

BRIX Extreme Ultra Compact PC Kit



Quick Start Guide

Kurzanleitung / Guide de démarrage rapide / Guía de inicio rápido / Guia de início rápido / Guida di avvio rapido / Краткое руководство / Skrócona instrukcja obsługi / Hızlı Başlangıç Kılavuzu / 快速入門使用者手冊 / 快速入门指南 / クイックスタートガイド / 빠른 시작 가이드

BRIX Extreme GB-BER Ultrakompaktes PC Kit / Kit PC ultra compact BRIX Extreme GB-BER / Kit de PC ultra compacto BRIX Extreme GB-BER / Kit PC BRIX Extreme GB-BER Ultra Compact / Kit per PC BRIX Extreme GB-BER Ultra Compatto / Ультракомпактный ПК BRIX Extreme GB-BEi, базовый комплект / Zestaw BRIX Extreme GB-BER Ultra Compact PC / BRIX Extreme GB-BER Ultra Kompakt PC Kiti / BRIX Extreme GB-BER 系列超微型電腦 / BRIX Extreme GB-BER 系列超紧凑型 PC 套件 / BRIX Extreme GB-BER 超小型PCキット / BRIX Extreme GB-BER Ultra Compact PC 키트

Getting Familiar with Your Unit

Erste Schritte mit Ihrem Gerät / Se familiariser avec votre appareil / Familiarizándose con su unidad / Familiarizar-se com a unidade / Imparare a conoscere la propria unità / Знакомство с изделием / Zapoznanie się z jednostką / Cihazınız Hakkında Bilgi Sahibi Olun / 認識您的裝置 (*系統操作溫度 0°C~35°C) / 了解您的设备 (*系統操作溫度 0°C~35°C) / ユニットを知る / 기기에 대해 알아보기

	STD Version GB-BER3-7335, GB-BER5-7535, GB-BER7-7840	HDD Version GB-BER3H-7335, GB-BER5H-7535	Expansion Card Version GB-BER3HS-7335, GB-BER5HS-7535, GB-BER7HS-7840
Front			
Rear			
Left			
Right			

	Bottom
No.	Description
1	Headphone/Microphone (耳機/麥克風)
2	USB 3.2 Gen2 Type C (5V/3A)
3	USB 3.2 Gen 2 Type A
4	Power Button (電源按鈕)
5	Mini DisplayPort
6	HDMI 2.1 FRL10 8K (7680 x 4320)
7	HDMI 2.1 FRL10 8K (7680 x 4320)
8	USB 2.0 Type A (5V/0.5A)
9	USB 3.2 Gen2 with Type C Alt Mode Thunderbolt 4 (5V/3A)
10	RJ-45 (10/100/1000/2500Mbps)
11	Kensington Lock Slot (防盜鎖槽)
12	DC-In (電源輸入)
13	Vent Hole (通風孔)
14	VESA Bracket Screw Holes (支架螺絲孔)
* : DP support DP1.4/3840x2160@60Hz	

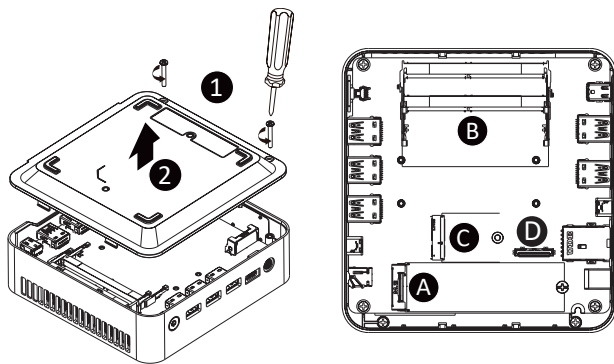

PIN Definition	
A	M.2 2280 SSD Connector
B	DDR SO-DIMM slot
C	Wi-Fi Connector
D	SATA connector for LAN/COM/M.2 Upgrade Kit (*Super SKU)

NOTE: Wireless module inclusion may vary based on local distribution.
 注意：根据各地经销商之产品规格配置，有些市场将不提供预载的无线模块。

A) M.2 SSD: How to Install the M.2 2280 SSD

M.2 SSD: Installation der M.2 2280 SSD / SSD M.2 : Comment installer le SSD M.2 2280 / SSD M.2: Como instalar el SSD M.2 2280 / M.2 SSD: Como instalar o M.2 2280 SSD / SSD M.2: Come installare l'SSD M.2 2280 / M.2 SSD: Установка модуля M.2 2280 SSD / M.2 SSD: Instalacja dysku SSD M.2 2280 / M.2 SSD: M.2 2280 SSD nasıl yüklenir / M.2 SSD : M.2 2280 SSD 安裝方式 / M.2 SSD : 如何安裝 M.2 2280 SSD / M.2 SSD : M.2 2280 SSDのインストール方法 / M.2 SSD: M.2 2280 SSD 설치 방법

- Remove the small screw secured to the M.2 SSD slot B screw hole. 取下 M.2 SSD B 插槽螺絲孔上的螺絲。
- Carefully insert the M.2 SSD into slot B. 小心地把 M.2 SSD 裝入 B 插槽。
- Insert the tab on the thermal plate into the slit near the connector, then secure the thermal plate and M.2 SSD in place with the previously removed screw. 把散熱片裝入插槽旁邊的缺口，然後用之前取下的螺絲將 M.2 SSD 與散熱片固定。

B) Memory Installation: SO-DIMM DDR4

Arbeitsspeicher Installation: SO-DIMM DDR4 / Installation de la mémoire : SO-DIMM DDR4 / Instalación de la memoria: SO-DIMM DDR4 / Instalação de memória: SO-DIMM DDR4 / Installazione della memoria: SO-DIMM DDR4 / Установка модулей памяти: SO-DIMM DDR4 / Instalacja pamięci: SO-DIMM DDR4 / Hafza Yükleme: SO-DIMM DDR4 / 安裝記憶體：SO-DIMM DDR4 / 内存安装：SO-DIMM DDR4 / 메모리インストール：SO-DIMM DDR4 / 메모리 설치: SO-DIMM DDR4

- Carefully insert SO-DIMM memory modules. 小心並由下至上安裝 SO-DIMM 記憶體於記憶體插槽。
- Push down until the modules click into place. 當記憶體固定於插槽後，再輕輕下壓至定點。
- Carefully insert SO-DIMM memory modules. 安裝下層記憶體後，重覆前述動作安裝上層記憶體。
- Push down until the modules click into place. 當記憶體固定於插槽後，再輕輕下壓至定點。

NOTE: Please ensure a thermal pad is attached on the motherboard before installing the SO-DIMM device into the system. Installing a SO-DIMM device without any thermal pad may result in the system overheating or system performance being throttled. 請確保在安裝 SO-DIMM 之前，在主機板上附加導熱片。在未附導熱片之情況下安裝 SO-DIMM，將有可能導致系統過熱或系統效能受到限制。

C) Wireless Module: How to Safely Remove the Module

Drahtlosmodul: Sicheres Entfernen des Moduls / Module sans fil : Comment retirer le module en toute sécurité / Módulo inalámbrico: Cómo quitar el módulo de forma segura / Módulo sem fios: Como remover com segurança o módulo / Modulo senza cavi: Come rimuovere il modulo in sicurezza / Беспроводной модуль: Безопасное отсоединение модуля / Moduł bezprzewodowy: Bezpieczne usuwanie modułu / Kablosuz Modül: Modül Güvenli Bir Şekilde nasıl Çıkarılır / 無線模組：安全移除模組的方式 / 无线模块：如何安全移除模块 / 와이파이레스모듈: 모듈의 안전한 분리 방법 / 무선 모듈: 모듈을 안전하게 제거하는 방법

- Disconnect the two antennas by manually lifting off the clips that hold them in place. 向上移除連接於無線模組左側頂端天線。
- Remove the screw in the middle. 鬆開固定於無線模組中央頂端的螺絲。
- Carefully pull the wireless module from the slot. 小心的把無線模組從 M.2 插槽拔除。

依據低功率電波輻射性電機管理辦法【第十二條】經型式認證合格之低功率射頻電機，非經許可公司、商號或使用者均不得擅自變更頻率、加大功率或變更原設計之特性及功能。【第十四條】低功率射頻電機之使用不得影響飛航安全及干擾合法通信；經發現有干擾現象時，應立即停用，並改善至無干擾時方得繼續使用。前項合法通信指依電信法規定作業之無線電通信。低功率射頻電機須忍受合法通信或工業、科學及醫療用電波輻射性電機設備之干擾。」

D) BRIX Extreme Support LAN/COM/M.2 Upgrade Kit: How to Install LAN/COM/M.2 Kit

NOTE: This system does not support the installation of both LAN/COM kit and 2.5" HDD; also the M.2 module here cannot be equipped with a thermal plate due to the space limitation.

- Unscrew and remove the bracket, and then disconnect the SATA cable. 將支架從底蓋上移除，並取下主機板上的 SATA 線。
- Connect the other end of the cable to the SATA connector on the motherboard. 將傳輸線的另一端接到主板上的 SATA 接頭。
- Install the upgrade kit board onto the bottom panel using the four screws provided, then connect the cable included in the upgrade kit to the upgrade kit board. 用隨附的四顆螺絲將升級套件固定在支架上，並將升級套件隨附的傳輸線接到升級套件上。
- Reinstall the bracket with upgrade kit to bottom panel. 將裝有升級套件的支架，鎖回底蓋上。

NOTE: Please ensure a thermal pad is attached on the motherboard before installing the M.2 into the upgrade kit. Installing a M.2 without any thermal pad may result in the system overheating or system performance being throttled. 請確保在安裝 M.2 之前，在升級套件上附加導熱片。在未附導熱片之情況下安裝 M.2，將有可能導致系統過熱或系統效能受到限制。

VESA Bracket

VESA Halterung / Support VESA / Soporte VESA / Suporte VESA / Staffa VESA / Кронштейн VESA / Wspornik VESA / VESA Braketi / VESA 支架 / VESA 支架 / VESA ブラケット / VESA 브래킷

NOTE! VESA screws: Length 5.0 mm with M3 type screws, Metal enclosure with bottom side.

- Attach the screws provided on the underside of the BRIX Extreme. 安裝隨附的 VESA 支撐架螺絲於 BRIX Extreme 底部。
- Attach the VESA mounting plate to the rear of a compatible display using the screws provided. 安裝隨附的 VESA 支撐架於支援 VESA 支撐架的電腦螢幕或電視機後背。
- The BRIX Extreme can now be mounted by sliding the device into place. 將已安裝 VESA 支撐架螺絲的 BRIX Extreme 插入 VESA 支撐架的滑軌孔，向下壓至定位點後即可固定。

單元 Unit	限用物質及其化學符號 Restricted substances and its chemical symbols					
	鉛 Lead (Pb)	汞 Mercury (Hg)	鎘 Cadmium (Cd)	六價鉻 Hexavalent chromium (Cr ⁶⁺)	多溴聯苯 Polybrominated biphenyls (PBB)	多溴二苯醚 Polybrominated diphenyl ethers (PBDE)
電路板總成	—	○	○	○	○	○
散熱器(含風扇)	—	○	○	○	○	○
無線網路卡	—	○	○	○	○	○
線材	—	○	○	○	○	○
外殼	—	○	○	○	○	○
電源供應器	—	○	○	○	○	○

備考1: “超出0.1 wt %”及“超出0.01 wt %”係指限用物質之百分比含量超出百分比含量基準值。
 Note 1: “Exceeding 0.1 wt %” and “exceeding 0.01 wt %” indicate that the percentage content of the restricted substance exceeds the reference percentage value of presence condition. ☒
 備考2: “○”係指該項限用物質之百分比含量未超出百分比含量基準值。
 Note 2: “○” indicates that the percentage content of the restricted substance does not exceed the percentage of reference value of presence.
 備考3: “—”係指該項限用物質為排除項目。
 Note 3: The “—” indicates that the restricted substance corresponds to the exemption. ☒