



# AORUS RTX 4090 GAMING BOX

With GeForce RTX™ 4090 graphics card embedded

Installation Guide

## ▶ PACKAGE CONTENT:

- AORUS RTX 4090 GAMING BOX  
(Includes GIGABYTE GeForce RTX™ 4090 24G graphics card)\*1
- Thunderbolt™ 3.0 cable 500mm (USB Type-C)\*1
- Power cord\*1
- Installation guide \*1

## ▶ SYSTEM REQUIREMENT:

- Laptop/Desktop PC with a Thunderbolt™ 3/ Thunderbolt™ 4 port and supports external GPU.
- Please confirm the Thunderbolt™ 3 compatibility with your PC manufacturer.
- Microsoft® Windows® 10/11 64-bit

## ▶ PRODUCT FEATURES:

- Powerful GeForce RTX™ 4090 delivers incredible performance for gamers and creators.
- WATERFORCE all-in-one cooling system
- Thunderbolt™ 3 plug and play
- Supports USB 3.2 Gen 1 \*3 for peripherals
- Supports Ethernet port
- Supports Power Delivery (PD 3.0) for Quick Charge
- RGB lighting

▶ I/O

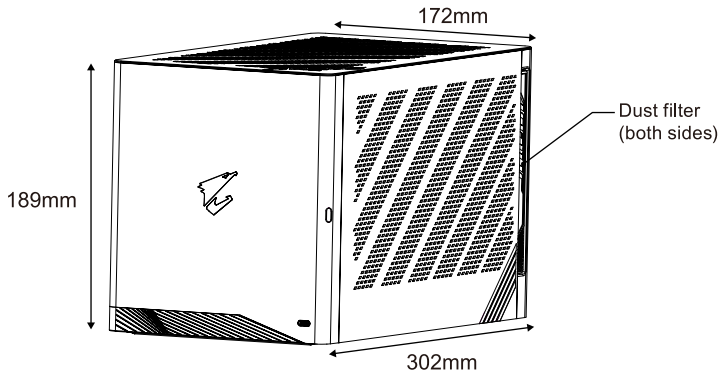
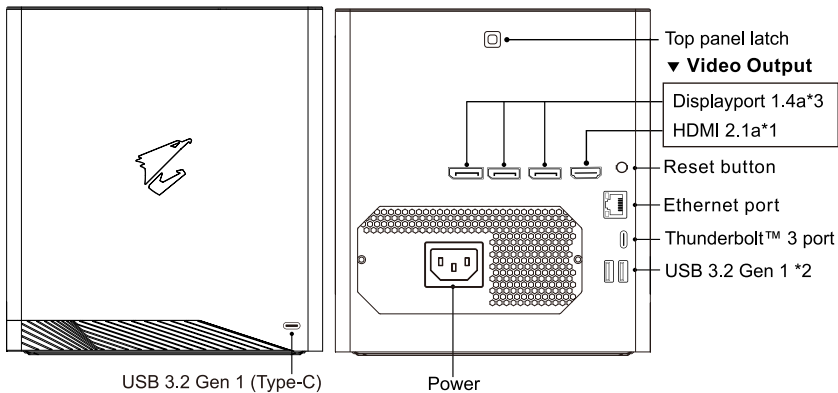

## ► INSTALLATION

1. Connect AORUS RTX 4090 GAMING BOX to a power source 100V~240V by the power cord.

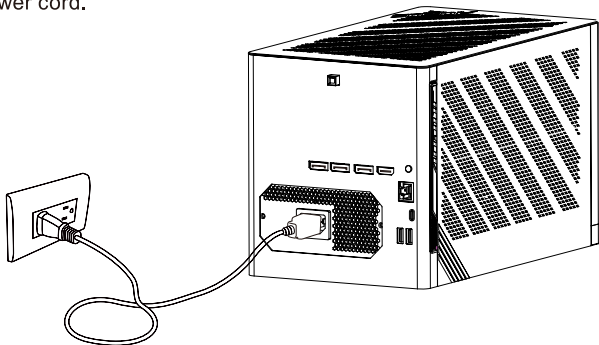

2. Connect AORUS RTX 4090 GAMING BOX to the Laptop / Desktop PC by Thunderbolt™ USB type-C cable.

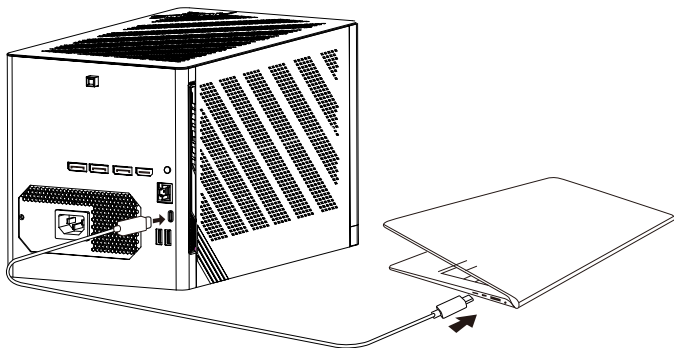

3. Click on to confirm the Thunderbolt™ connection of “GIGABYTE, GAMING BOX ”  
When it's connected, the RGB light of the box will turn on.

3-1 Click on OK, when the Thunderbolt™ cable is connected to PC.

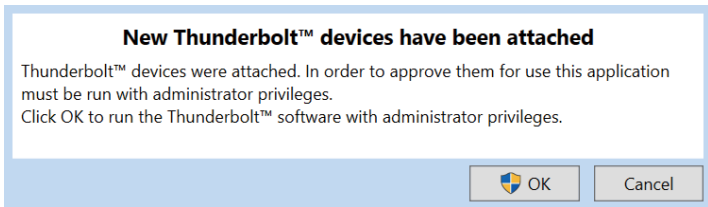

3-2 Choose “Always connect” for “GIGABYTE, GAMING BOX ”

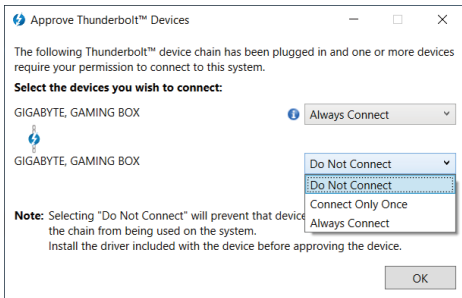

4. Connect AORUS RTX 4090 GAMING BOX to your external monitor by the DP (display port) or HDMI

Note:

You can connect a USB keyboard, USB mouse and USB headset to AORUS RTX 4090 GAMING BOX

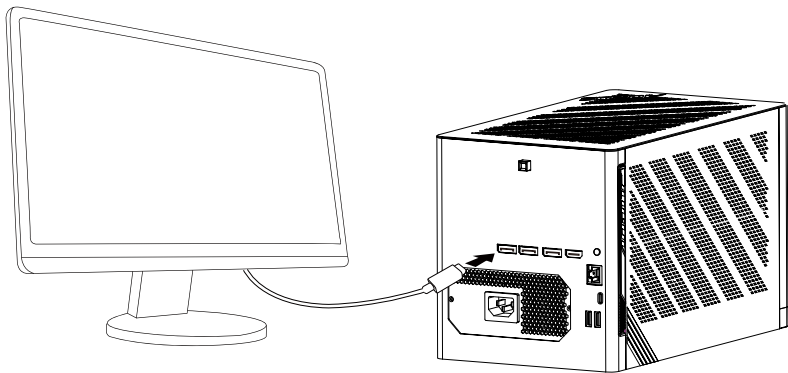

5. Connect the Ethernet cable to the Ethernet port to use the wired network.
6. Install the RTX 4090 graphics card driver from GIGABYTE website.
7. Install the GIGABYTE CONTROL CENTER to customize your preference.

Note:

1. How to check if the application is running by the external GPU – GeForce RTX™ 4090.
  - 1-1. Click on the icon  [ Nvidia GPU Activity ] in the notification area. (If there is no icon, please add it from NVIDIA Control Panel. Make sure the graphics driver is installed)

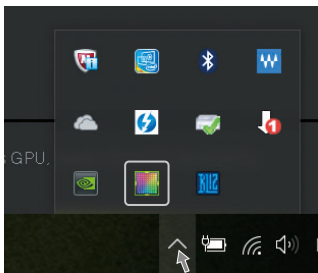

- 1-2. Display the applications that are running by external GPU - GeForce RTX™ 4090.

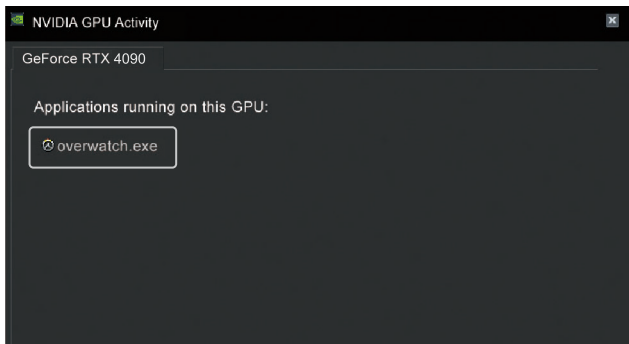

2. Before you re-plug the Thunderbolt™ cable, please wait until the Thunderbolt™ disconnected sound is played and the icon  in the notification area is disappeared. If the PC can't recognize the Thunderbolt™ device, please reboot the system.
3. If the Thunderbolt™ is not connected in the system after rebooting the laptop, you may push the “Reset” button to wake up the GAMING BOX. The function of the “Reset” button is equivalent to re-plug the power cord.
4. Please keep the clearance near the box for better airflow. Poor ventilation will reduce the performance of the graphics card.
5. How to keep the PC working with the lid closed – go to Windows setting → Control panel\Hardware and Sound\Power Options\System Settings. Then set the item “When I close the lid” to “Do nothing”.

#### Power and sleep buttons and lid settings

---



On battery



Plugged in



When I press the power button:

Sleep

Sleep



When I press the sleep button:

Sleep

Sleep



When I close the lid:

Do nothing

Do nothing



## **Safety information :**

Operating Temperature: +10°C to +35°C

Storage Temperature: -40°C to +70°C

Operating Altitude: to 3000M

Do not remove the casing of this product during operation

To safely remove the top and side panels of the chassis –

- 1.Press down all the way on the top panel latch on the back of the chassis
- 2.Push and slide the top panel towards the back of the gaming box and lift to remove the top panel
- 3.Remove the dust filters completely by pulling them towards the back of the chassis
- 4.The two side panels then can be removed by sliding them up and lifting away from the chassis

To assemble the gaming box back together –

- 1.Align the rivets on both side panels with the notches on the box, then slide the side panels down
- 2.Slide the dust filters towards the front of the chassis
- 3.Press and slide the top panel towards the front of the gaming box until you hear a click sound

GAMING BOX state	RGB light	Fan	Water pump	Note
Turn on	On	On	On	Connect GAMING BOX to the laptop PC and Thunderbolt™ is activated.
Standby	Off	Off	Off	Power cord is connected. PC is shutdown.
Turn off	Off	Off	Off	Disconnect the power cord or press the "Reset" button over 3 seconds to turn off. Press the "Reset" button again to turn on.

UK  
CA



CE FC



EAC

**HDMI**™  
HIGH-DEFINITION MULTIMEDIA INTERFACE

AC INPUT: 100-240V~/ 12-6A/ 50-60Hz (200-240V~/6A/50-60Hz, 限用中國地區)

**GIGA-BYTE TECHNOLOGY CO.,LTD.**

No.6,Baoqiang Rd., Xindian Dist., New Taipei City 231  
www.gigabyte.com

**GBT TECH. CO.,LTD**

13 Warren Yard, Warren Farm Office Village, Wolverton Mill,  
Milton Keynes, MK12 5NW, United Kingdom

## Enabling or disabling the ErP LPS compliance mode

This Gaming Box meets the eco-design requirements of the ErP Lot 26 regulation.

You can enable the ErP LPS compliance mode in Gigabyte Control Center to reduce the consumption of electricity when your computer is off or in sleep mode.

To enable or disable ErP LPS compliance mode, do one of the following:

### **A. Using GCC Software**

1. Start Gigabyte Control Center
2. Navigate to the home page and select the Gaming Box device
3. Under performance tab, select "Enable" for ErP LPS compliance mode, and set how many minutes the device will enter ErP LPS compliance mode after computer is off or in sleep mode
4. Click "Apply" to save the setting

### **B. Using the Reset button**

1. Press and hold the Reset button for 4 seconds to enter ErP compliance mode directly

When the ErP LPS compliance mode is enabled, you can wake up the gaming box by pressing the Reset button once.



#### Copyright

© 2023 GIGABYTE TECHNOLOGY CO., LTD

Copyright by GIGA-BYTE TECHNOLOGY CO., LTD. ("GBT"). No part of this manual may be reproduced or transmitted in any form without the expressed, written permission of GBT.

#### Trademarks

Third-party brands and names are the properties of their respective owners.

#### Notice

Please do not remove any labels on this graphics card box. Doing so may void the warranty of this card. Due to rapid change in technology, some of the specifications might be out of date before publication of this manual. The author assumes no responsibility for any errors or omissions that may appear in this document nor does the author make a commitment to update the information contained herein.

廠商料號條碼

12WE6-N409EB-0\*R